

PRECALCULUS

VERSION $[\pi] = 3$

UConn Edition

BY

CARL STITZ, Ph.D.

JEFF ZEAGER, Ph.D.

LAKELAND COMMUNITY COLLEGE LORAIN COUNTY COMMUNITY COLLEGE

JULY 4, 2013

ACKNOWLEDGEMENTS

While the cover of this textbook lists only two names, the book as it stands today would simply not exist if not for the tireless work and dedication of several people. First and foremost, we wish to thank our families for their patience and support during the creative process. We would also like to thank our students - the sole inspiration for the work. Among our colleagues, we wish to thank Rich Basich, Bill Previts, and Irina Lomonosov, who not only were early adopters of the textbook, but also contributed materials to the project. Special thanks go to Katie Cimperman, Terry Dykstra, Frank LeMay, and Rich Hagen who provided valuable feedback from the classroom. Thanks also to David Stumpf, Ivana Gorgievska, Jorge Gerszonowicz, Kathryn Arocho, Heather Bubnick, and Florin Muscutariu for their unwaivering support (and sometimes defense) of the book. From outside the classroom, we wish to thank Don Anthan and Ken White, who designed the electric circuit applications used in the text, as well as Drs. Wendy Marley and Marcia Ballinger for the Lorain CCC enrollment data used in the text. The authors are also indebted to the good folks at our schools' bookstores, Gwen Sevtis (Lakeland CC) and Chris Callahan (Lorain CCC), for working with us to get printed copies to the students as inexpensively as possible. We would also like to thank Lakeland folks Jeri Dickinson, Mary Ann Blakeley, Jessica Novak, and Corrie Bergeron for their enthusiasm and promotion of the project. The administrations at both schools have also been very supportive of the project, so from Lakeland, we wish to thank Dr. Morris W. Beverage, Jr., President, Dr. Fred Law, Provost, Deans Don Anthan and Dr. Steve Oluic, and the Board of Trustees. From Lorain County Community College, we wish to thank Dr. Roy A. Church, Dr. Karen Wells, and the Board of Trustees. From the Ohio Board of Regents, we wish to thank former Chancellor Eric Fingerhut, Darlene McCoy, Associate Vice Chancellor of Affordability and Efficiency, and Kelly Bernard. From OhioLINK, we wish to thank Steve Acker, John Magill, and Stacy Brannan. We also wish to thank the good folks at WebAssign, most notably Chris Hall, COO, and Joel Hollenbeck (former VP of Sales.) Last, but certainly not least, we wish to thank all the folks who have contacted us over the interwebs, most notably Dimitri Moonen and Joel Wordsworth, who gave us great feedback, and Antonio Olivares who helped debug the source code.

The cover image was taken by Ken Lund (licensed as CC-BY), and the back image was taken by the U.S. Fish and Wildlife Service (USFWS). This volume was arranged by Stephen Flood to focus on the topics used at the University of Connecticut.

TABLE OF CONTENTS

Preface	ix
0 Prerequisites	1
0.1 Basic Set Theory and Interval Notation	3
0.1.1 Some Basic Set Theory Notions	3
0.1.2 Sets of Real Numbers	5
0.1.3 Exercises	13
0.1.4 Answers	15
0.2 Real Number Arithmetic	18
0.2.1 Exercises	37
0.2.2 Answers	38
0.3 Linear Equations and Inequalities	39
0.3.1 Linear Equations	39
0.3.2 Linear Inequalities	44
0.3.3 Exercises	48
0.3.4 Answers	50
0.4 Absolute Value Equations and Inequalities	52
0.4.1 Absolute Value Equations	53
0.4.2 Absolute Value Inequalities	55
0.4.3 Exercises	59
0.4.4 Answers	60
0.5 Polynomial Arithmetic	61
0.5.1 Polynomial Addition, Subtraction and Multiplication.	62
0.5.2 Polynomial Long Division.	65
0.5.3 Exercises	69
0.5.4 Answers	70
0.6 Factoring	71
0.6.1 Solving Equations by Factoring	77
0.6.2 Exercises	82
0.6.3 Answers	83
0.7 Quadratic Equations	84
0.7.1 Exercises	95

	0.7.2	Answers	96
0.8		Rational Expressions and Equations	97
	0.8.1	Exercises	109
	0.8.2	Answers	111
0.9		Radicals and Equations	112
	0.9.1	Rationalizing Denominators and Numerators	120
	0.9.2	Exercises	125
	0.9.3	Answers	126
0.10		Circles	127
	0.10.1	Exercises	131
	0.10.2	Answers	132
1		Relations and Functions	135
1.1		Sets of Real Numbers and the Cartesian Coordinate Plane	135
	1.1.1	Sets of Numbers	135
	1.1.2	The Cartesian Coordinate Plane	140
	1.1.3	Distance in the Plane	144
	1.1.4	Exercises	148
	1.1.5	Answers	151
1.2		Relations	154
	1.2.1	Graphs of Equations	157
	1.2.2	Exercises	163
	1.2.3	Answers	167
1.3		Introduction to Functions	177
	1.3.1	Exercises	183
	1.3.2	Answers	187
1.4		Function Notation	189
	1.4.1	Modeling with Functions	194
	1.4.2	Exercises	197
	1.4.3	Answers	203
1.5		Function Arithmetic	210
	1.5.1	Exercises	218
	1.5.2	Answers	221
1.6		Graphs of Functions	227
	1.6.1	General Function Behavior	234
	1.6.2	Exercises	241
	1.6.3	Answers	248
1.7		Transformations	254
	1.7.1	Exercises	274
	1.7.2	Answers	278

2	Linear and Quadratic Functions	285
2.1	Linear Functions	285
2.1.1	Exercises	297
2.1.2	Answers	303
2.2	Absolute Value Functions	307
2.2.1	Exercises	317
2.2.2	Answers	318
2.3	Quadratic Functions	322
2.3.1	Exercises	334
2.3.2	Answers	337
2.4	Inequalities with Absolute Value and Quadratic Functions	342
2.4.1	Exercises	354
2.4.2	Answers	356
2.5	Regression	359
2.5.1	Exercises	364
2.5.2	Answers	367
3	Polynomial Functions	369
3.1	Graphs of Polynomials	369
3.1.1	Exercises	380
3.1.2	Answers	384
3.2	The Factor Theorem and the Remainder Theorem	391
3.2.1	Exercises	399
3.2.2	Answers	401
3.3	Real Zeros of Polynomials	403
3.3.1	For Those Wishing to use a Graphing Calculator	404
3.3.2	For Those Wishing NOT to use a Graphing Calculator	407
3.3.3	Exercises	414
3.3.4	Answers	417
3.4	Complex Zeros and the Fundamental Theorem of Algebra	421
3.4.1	Exercises	429
3.4.2	Answers	431
4	Rational Functions	435
4.1	Introduction to Rational Functions	435
4.1.1	Exercises	448
4.1.2	Answers	450
4.2	Graphs of Rational Functions	454
4.2.1	Exercises	467
4.2.2	Answers	469
4.3	Rational Inequalities and Applications	476
4.3.1	Variation	484
4.3.2	Exercises	487

4.3.3	Answers	490
5	Further Topics in Functions	493
5.1	Function Composition	493
5.1.1	Exercises	503
5.1.2	Answers	506
5.2	Inverse Functions	512
5.2.1	Exercises	528
5.2.2	Answers	530
5.3	Other Algebraic Functions	531
5.3.1	Exercises	541
5.3.2	Answers	545
6	Exponential and Logarithmic Functions	551
6.1	Introduction to Exponential and Logarithmic Functions	551
6.1.1	Exercises	563
6.1.2	Answers	567
6.2	Properties of Logarithms	571
6.2.1	Exercises	579
6.2.2	Answers	581
6.3	Exponential Equations and Inequalities	582
6.3.1	Exercises	590
6.3.2	Answers	592
6.4	Logarithmic Equations and Inequalities	593
6.4.1	Exercises	600
6.4.2	Answers	602
6.5	Applications of Exponential and Logarithmic Functions	603
6.5.1	Applications of Exponential Functions	603
6.5.2	Applications of Logarithms	611
6.5.3	Exercises	616
6.5.4	Answers	624
7	Systems of Equations and Matrices	629
7.1	Systems of Linear Equations: Gaussian Elimination	629
7.1.1	Exercises	642
7.1.2	Answers	644
7.2	Systems of Non-Linear Equations and Inequalities	647
7.2.1	Exercises	656
7.2.2	Answers	658

8	Foundations of Trigonometry	661
8.1	Angles and their Measure	661
8.1.1	Applications of Radian Measure: Circular Motion	674
8.1.2	Exercises	677
8.1.3	Answers	680
8.2	The Unit Circle: Cosine and Sine	685
8.2.1	Beyond the Unit Circle	698
8.2.2	Exercises	704
8.2.3	Answers	708
8.3	The Six Circular Functions and Fundamental Identities	712
8.3.1	Beyond the Unit Circle	720
8.3.2	Exercises	727
8.3.3	Answers	734
8.4	Trigonometric Identities	738
8.4.1	Exercises	750
8.4.2	Answers	755
8.5	Graphs of the Trigonometric Functions	758
8.5.1	Graphs of the Cosine and Sine Functions	758
8.5.2	Graphs of the Secant and Cosecant Functions	768
8.5.3	Graphs of the Tangent and Cotangent Functions	772
8.5.4	Exercises	777
8.5.5	Answers	779
8.6	The Inverse Trigonometric Functions	787
8.6.1	Inverses of Secant and Cosecant: Trigonometry Friendly Approach	795
8.6.2	Inverses of Secant and Cosecant: Calculus Friendly Approach	798
8.6.3	Calculators and the Inverse Circular Functions.	801
8.6.4	Solving Equations Using the Inverse Trigonometric Functions.	806
8.6.5	Exercises	809
8.6.6	Answers	817
8.7	Trigonometric Equations and Inequalities	825
8.7.1	Exercises	842
8.7.2	Answers	845
9	Applications of Trigonometry	849
9.1	Applications of Sinusoids	849
9.1.1	Harmonic Motion	853
9.1.2	Exercises	859
9.1.3	Answers	862
9.2	The Law of Sines	864
9.2.1	Exercises	872
9.2.2	Answers	876
9.3	Polar Coordinates	878

9.3.1	Exercises	889
9.3.2	Answers	891
Index		897

PREFACE

Thank you for your interest in our book, but more importantly, thank you for taking the time to read the Preface. I always read the Prefaces of the textbooks which I use in my classes because I believe it is in the Preface where I begin to understand the authors - who they are, what their motivation for writing the book was, and what they hope the reader will get out of reading the text. Pedagogical issues such as content organization and how professors and students should best use a book can usually be gleaned out of its Table of Contents, but the reasons behind the choices authors make should be shared in the Preface. Also, I feel that the Preface of a textbook should demonstrate the authors' love of their discipline and passion for teaching, so that I come away believing that they really want to help students and not just make money. Thus, I thank my fellow Preface-readers again for giving me the opportunity to share with you the need and vision which guided the creation of this book and passion which both Carl and I hold for Mathematics and the teaching of it.

Carl and I are natives of Northeast Ohio. We met in graduate school at Kent State University in 1997. I finished my Ph.D in Pure Mathematics in August 1998 and started teaching at Lorain County Community College in Elyria, Ohio just two days after graduation. Carl earned his Ph.D in Pure Mathematics in August 2000 and started teaching at Lakeland Community College in Kirtland, Ohio that same month. Our schools are fairly similar in size and mission and each serves a similar population of students. The students range in age from about 16 (Ohio has a Post-Secondary Enrollment Option program which allows high school students to take college courses for free while still in high school.) to over 65. Many of the "non-traditional" students are returning to school in order to change careers. A majority of the students at both schools receive some sort of financial aid, be it scholarships from the schools' foundations, state-funded grants or federal financial aid like student loans, and many of them have lives busied by family and job demands. Some will be taking their Associate degrees and entering (or re-entering) the workforce while others will be continuing on to a four-year college or university. Despite their many differences, our students share one common attribute: they do not want to spend \$200 on a College Algebra book.

The challenge of reducing the cost of textbooks is one that many states, including Ohio, are taking quite seriously. Indeed, state-level leaders have started to work with faculty from several of the colleges and universities in Ohio and with the major publishers as well. That process will take considerable time so Carl and I came up with a plan of our own. We decided that the best way to help our students right now was to write our own College Algebra book and give it away electronically for free. We were granted sabbaticals from our respective institutions for the Spring

semester of 2009 and actually began writing the textbook on December 16, 2008. Using an open-source text editor called TexNicCenter and an open-source distribution of LaTeX called MikTeX 2.7, Carl and I wrote and edited all of the text, exercises and answers and created all of the graphs (using Metapost within LaTeX) for Version 0.9 in about eight months. (We choose to create a text in only black and white to keep printing costs to a minimum for those students who prefer a printed edition. This somewhat Spartan page layout stands in sharp relief to the explosion of colors found in most other College Algebra texts, but neither Carl nor I believe the four-color print adds anything of value.) I used the book in three sections of College Algebra at Lorain County Community College in the Fall of 2009 and Carl's colleague, Dr. Bill Previts, taught a section of College Algebra at Lakeland with the book that semester as well. Students had the option of downloading the book as a .pdf file from our website www.stitz-zeager.com or buying a low-cost printed version from our colleges' respective bookstores. (By giving this book away for free electronically, we end the cycle of new editions appearing every 18 months to curtail the used book market.) During Thanksgiving break in November 2009, many additional exercises written by Dr. Previts were added and the typographical errors found by our students and others were corrected. On December 10, 2009, Version $\sqrt{2}$ was released. The book remains free for download at our website and by using Lulu.com as an on-demand printing service, our bookstores are now able to provide a printed edition for just under \$19. Neither Carl nor I have, or will ever, receive any royalties from the printed editions. As a contribution back to the open-source community, all of the LaTeX files used to compile the book are available for free under a Creative Commons License on our website as well. That way, anyone who would like to rearrange or edit the content for their classes can do so as long as it remains free.

The only disadvantage to not working for a publisher is that we don't have a paid editorial staff. What we have instead, beyond ourselves, is friends, colleagues and unknown people in the open-source community who alert us to errors they find as they read the textbook. What we gain in not having to report to a publisher so dramatically outweighs the lack of the paid staff that we have turned down every offer to publish our book. (As of the writing of this Preface, we've had three offers.) By maintaining this book by ourselves, Carl and I retain all creative control and keep the book our own. We control the organization, depth and rigor of the content which means we can resist the pressure to diminish the rigor and homogenize the content so as to appeal to a mass market. A casual glance through the Table of Contents of most of the major publishers' College Algebra books reveals nearly isomorphic content in both order and depth. Our Table of Contents shows a different approach, one that might be labeled "Functions First." To truly use The Rule of Four, that is, in order to discuss each new concept algebraically, graphically, numerically and verbally, it seems completely obvious to us that one would need to introduce functions first. (Take a moment and compare our ordering to the classic "equations first, then the Cartesian Plane and THEN functions" approach seen in most of the major players.) We then introduce a class of functions and discuss the equations, inequalities (with a heavy emphasis on sign diagrams) and applications which involve functions in that class. The material is presented at a level that definitely prepares a student for Calculus while giving them relevant Mathematics which can be used in other classes as well. Graphing calculators are used sparingly and only as a tool to enhance the Mathematics, not to replace it. The answers to nearly all of the computational homework exercises are given in the

text and we have gone to great lengths to write some very thought provoking discussion questions whose answers are not given. One will notice that our exercise sets are much shorter than the traditional sets of nearly 100 “drill and kill” questions which build skill devoid of understanding. Our experience has been that students can do about 15-20 homework exercises a night so we very carefully chose smaller sets of questions which cover all of the necessary skills and get the students thinking more deeply about the Mathematics involved.

Critics of the Open Educational Resource movement might quip that “open-source is where bad content goes to die,” to which I say this: take a serious look at what we offer our students. Look through a few sections to see if what we’ve written is bad content in your opinion. I see this open-source book not as something which is “free and worth every penny”, but rather, as a high quality alternative to the business as usual of the textbook industry and I hope that you agree. If you have any comments, questions or concerns please feel free to contact me at jeff@stitz-zeager.com or Carl at carl@stitz-zeager.com.

Jeff Zeager
Lorain County Community College
January 25, 2010

CHAPTER 0

PREREQUISITES

The authors would like nothing more than to dive right into the sheer excitement of Precalculus. However, experience - our own as well as that of our colleagues - has taught us that it is beneficial, if not completely necessary, to review what students should know before embarking on a Precalculus adventure. The goal of Chapter 0 is exactly that: to review the concepts, skills and vocabulary we believe are prerequisite to a rigorous, college-level Precalculus course. This review is not designed to teach the material to students who have never seen it before thus the presentation is more succinct and the exercise sets are shorter than those usually found in an Intermediate Algebra text. An outline of the chapter is given below.

Section 0.1 (Basic Set Theory and Interval Notation) contains a brief summary of the set theory terminology used throughout the text including sets of real numbers and interval notation.

Section 0.2 (Real Number Arithmetic) lists the properties of real number arithmetic.¹

Section 0.3 (Linear Equations and Inequalities) focuses on solving linear equations and linear inequalities from a strictly algebraic perspective. The geometry of graphing lines in the plane is deferred until Section 2.1 (Linear Functions).

Section 0.4 (Absolute Value Equations and Inequalities) begins with a definition of absolute value as a distance. Fundamental properties of absolute value are listed and then basic equations and inequalities involving absolute value are solved using the ‘distance definition’ and those properties. Absolute value is revisited in much greater depth in Section 2.2 (Absolute Value Functions).

Section 0.5 (Polynomial Arithmetic) covers the addition, subtraction, multiplication and division of polynomials as well as the vocabulary which is used extensively when the graphs of polynomials are studied in Chapter 3 (Polynomials).

Section 0.6 (Factoring) covers basic factoring techniques and how to solve equations using those techniques along with the Zero Product Property of Real Numbers.

Section 0.7 (Quadratic Equations) discusses solving quadratic equations using the technique of ‘completing the square’ and by using the Quadratic Formula. Equations which are ‘quadratic in form’ are also discussed.

¹You know, the stuff students mess up all of the time like fractions and negative signs. The collection is close to exhaustive and definitely exhausting!

Section 0.8 (Rational Expressions and Equations) starts with the basic arithmetic of rational expressions and the simplifying of compound fractions. Solving equations by clearing denominators and the handling negative integer exponents are presented but the graphing of rational functions is deferred until Chapter 4 (Rational Functions).

Section 0.9 (Radicals and Equations) covers simplifying radicals as well as the solving of basic equations involving radicals.

0.1 BASIC SET THEORY AND INTERVAL NOTATION

0.1.1 SOME BASIC SET THEORY NOTIONS

Like all good Math books, we begin with a definition.

Definition 0.1. A **set** is a well-defined collection of objects which are called the ‘elements’ of the set. Here, ‘well-defined’ means that it is possible to determine if something belongs to the collection or not, without prejudice.

The collection of letters that make up the word “smolko” is well-defined and is a set, but the collection of the worst Math teachers in the world is **not** well-defined and therefore is **not** a set.¹ In general, there are three ways to describe sets and those methods are listed below.

Ways to Describe Sets

1. **The Verbal Method:** Use a sentence to define the set.
2. **The Roster Method:** Begin with a left brace ‘{’, list each element of the set *only once* and then end with a right brace ‘}’.
3. **The Set-Builder Method:** A combination of the verbal and roster methods using a “dummy variable” such as x .

For example, let S be the set described *verbally* as the set of letters that make up the word “smolko”. A **roster** description of S is $\{s, m, o, l, k\}$. Note that we listed ‘o’ only once, even though it appears twice in the word “smolko”. Also, the *order* of the elements doesn’t matter, so $\{k, l, m, o, s\}$ is also a roster description of S . Moving right along, a **set-builder** description of S is: $\{x \mid x \text{ is a letter in the word “smolko”}\}$. The way to read this is ‘The set of elements x such that x is a letter in the word “smolko”.’ In each of the above cases, we may use the familiar equals sign ‘=’ and write $S = \{s, m, o, l, k\}$ or $S = \{x \mid x \text{ is a letter in the word “smolko”}\}$.

Notice that m is in S but many other letters, such as q , are not in S . We express these ideas of set inclusion and exclusion mathematically using the symbols $m \in S$ (read ‘ m is in S ’) and $q \notin S$ (read ‘ q is not in S ’). More precisely, we have the following.

Definition 0.2. Let A be a set.

- If x is an element of A then we write $x \in A$ which is read ‘ x is in A ’.
- If x is *not* an element of A then we write $x \notin A$ which is read ‘ x is not in A ’.

Now let’s consider the set $C = \{x \mid x \text{ is a consonant in the word “smolko”}\}$. A roster description of C is $C = \{s, m, l, k\}$. Note that by construction, every element of C is also in S . We express this relationship by stating that the set C is a **subset** of the set S , which is written in symbols as $C \subseteq S$. The more formal definition is given below.

¹For a more thought-provoking example, consider the collection of all things that do not contain themselves - this leads to the famous [Russell’s Paradox](#).

Definition 0.3. Given sets A and B , we say that the set A is a **subset** of the set B and write ' $A \subseteq B$ ' if every element in A is also an element of B .

Note that in our example above $C \subseteq S$, but not vice-versa, since $o \in S$ but $o \notin C$. Additionally, the set of vowels $V = \{a, e, i, o, u\}$, while it does have an element in common with S , is not a subset of S . (As an added note, S is not a subset of V , either.) We could, however, *build* a set which contains both S and V as subsets by gathering all of the elements in both S and V together into a single set, say $U = \{s, m, o, l, k, a, e, i, u\}$. Then $S \subseteq U$ and $V \subseteq U$. The set U we have built is called the **union** of the sets S and V and is denoted $S \cup V$. Furthermore, S and V aren't completely *different* sets since they both contain the letter 'o.' The **intersection** of two sets is the set of elements (if any) the two sets have in common. In this case, the intersection of S and V is $\{o\}$, written $S \cap V = \{o\}$. We formalize these ideas below.

Definition 0.4. Suppose A and B are sets.

- The **intersection** of A and B is $A \cap B = \{x \mid x \in A \text{ and } x \in B\}$
- The **union** of A and B is $A \cup B = \{x \mid x \in A \text{ or } x \in B \text{ (or both)}\}$

The key words in Definition 0.4 to focus on are the conjunctions: 'intersection' corresponds to 'and' meaning the elements have to be in *both* sets to be in the intersection, whereas 'union' corresponds to 'or' meaning the elements have to be in one set, or the other set (or both). In other words, to belong to the union of two sets an element must belong to *at least one* of them.

Returning to the sets C and V above, $C \cup V = \{s, m, l, k, a, e, i, o, u\}$.² When it comes to their intersection, however, we run into a bit of notational awkwardness since C and V have no elements in common. While we could write $C \cap V = \{\}$, this sort of thing happens often enough that we give the set with no elements a name.

Definition 0.5. The **Empty Set** \emptyset is the set which contains no elements. That is,

$$\emptyset = \{\} = \{x \mid x \neq x\}.$$

As promised, the empty set is the set containing no elements since no matter what ' x ' is, ' $x = x$.' Like the number '0,' the empty set plays a vital role in mathematics.³ We introduce it here more as a symbol of convenience as opposed to a contrivance.⁴ Using this new bit of notation, we have for the sets C and V above that $C \cap V = \emptyset$. A nice way to visualize relationships between sets and set operations is to draw a [Venn Diagram](#). A Venn Diagram for the sets S , C and V is drawn at the top of the next page.

²Which just so happens to be the same set as $S \cup V$.

³Sadly, the full extent of the empty set's role will not be explored in this text.

⁴Actually, the empty set can be used to generate numbers - mathematicians can create something from nothing!

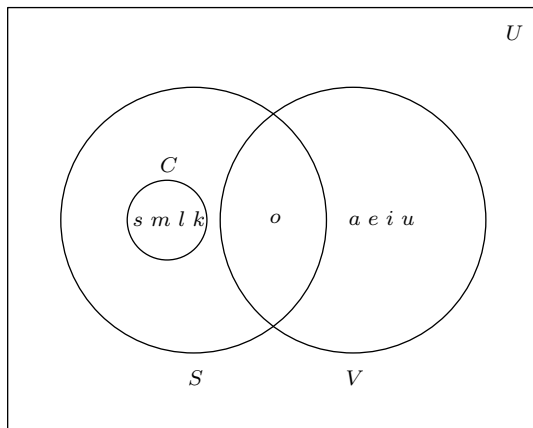
A Venn Diagram for C , S and V .

In the Venn Diagram above we have three circles - one for each of the sets C , S and V . We visualize the area enclosed by each of these circles as the elements of each set. Here, we've spelled out the elements for definitiveness. Notice that the circle representing the set C is completely inside the circle representing S . This is a geometric way of showing that $C \subseteq S$. Also, notice that the circles representing S and V overlap on the letter 'o'. This common region is how we visualize $S \cap V$. Notice that since $C \cap V = \emptyset$, the circles which represent C and V have no overlap whatsoever.

All of these circles lie in a rectangle labeled U (for 'universal' set). A universal set contains all of the elements under discussion, so it could always be taken as the union of all of the sets in question, or an even larger set. In this case, we could take $U = S \cup V$ or U as the set of letters in the entire alphabet. The reader may well wonder if there is an ultimate universal set which contains *everything*. The short answer is 'no' and we refer you once again to [Russell's Paradox](#). The usual triptych of Venn Diagrams indicating generic sets A and B along with $A \cap B$ and $A \cup B$ is given below.

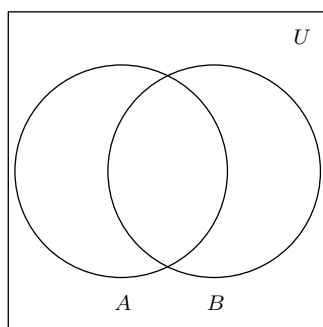
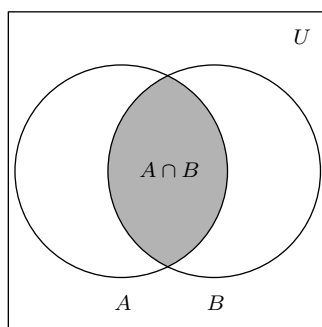
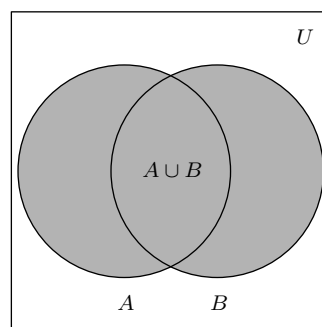
Sets A and B . $A \cap B$ is shaded. $A \cup B$ is shaded.

0.1.2 SETS OF REAL NUMBERS

The playground for most of this text is the set of **Real Numbers**. Many quantities in the 'real world' can be quantified using real numbers: the temperature at a given time, the revenue generated

by selling a certain number of products and the maximum population of Sasquatch which can inhabit a particular region are just three basic examples. A succinct, but nonetheless incomplete⁵ definition of a real number is given below.

Definition 0.6. A **real number** is any number which possesses a decimal representation. The set of real numbers is denoted by the character \mathbb{R} .

Certain subsets of the real numbers are worthy of note and are listed below. In fact, in more advanced texts,⁶ the real numbers are *constructed* from some of these subsets.

Special Subsets of Real Numbers

1. The **Natural Numbers**: $\mathbb{N} = \{1, 2, 3, \dots\}$ The periods of ellipsis ‘...’ here indicate that the natural numbers contain 1, 2, 3 ‘and so forth’.
2. The **Whole Numbers**: $\mathbb{W} = \{0, 1, 2, \dots\}$.
3. The **Integers**: $\mathbb{Z} = \{\dots, -3, -2, -1, 0, 1, 2, 3, \dots\} = \{0, \pm 1, \pm 2, \pm 3, \dots\}$.^a
4. The **Rational Numbers**: $\mathbb{Q} = \{\frac{a}{b} \mid a \in \mathbb{Z} \text{ and } b \in \mathbb{Z}\}$. Rational numbers are the ratios of integers where the denominator is not zero. It turns out that another way to describe the rational numbers is:

$$\mathbb{Q} = \{x \mid x \text{ possesses a repeating or terminating decimal representation}\}$$

5. The **Irrational Numbers**: $\mathbb{P} = \{x \mid x \in \mathbb{R} \text{ but } x \notin \mathbb{Q}\}$.^b That is, an irrational number is a real number which isn’t rational. Said differently,

$$\mathbb{P} = \{x \mid x \text{ possesses a decimal representation which neither repeats nor terminates}\}$$

^aThe symbol \pm is read ‘plus or minus’ and it is a shorthand notation which appears throughout the text. Just remember that $x = \pm 3$ means $x = 3$ or $x = -3$.

^bExamples here include number π (See Section 8.1), $\sqrt{2}$ and 0.101001000100001...

Note that every natural number is a whole number which, in turn, is an integer. Each integer is a rational number (take $b = 1$ in the above definition for \mathbb{Q}) and since every rational number is a real number⁷ the sets \mathbb{N} , \mathbb{W} , \mathbb{Z} , \mathbb{Q} , and \mathbb{R} are nested like [Matryoshka dolls](#). More formally, these sets form a subset chain: $\mathbb{N} \subseteq \mathbb{W} \subseteq \mathbb{Z} \subseteq \mathbb{Q} \subseteq \mathbb{R}$. The reader is encouraged to sketch a Venn Diagram depicting \mathbb{R} and all of the subsets mentioned above. It is time for an example.

Example 0.1.1.

1. Write a roster description for $P = \{2^n \mid n \in \mathbb{N}\}$ and $E = \{2n \mid n \in \mathbb{Z}\}$.

⁵Math pun intended!

⁶See, for instance, Landau’s [Foundations of Analysis](#).

⁷Thanks to long division!

2. Write a verbal description for $S = \{x^2 \mid x \in \mathbb{R}\}$.
3. Let $A = \{-117, \frac{4}{5}, 0.20\overline{2002}, 0.202002000200002\dots\}$.
 - (a) Which elements of A are natural numbers? Rational numbers? Real numbers?
 - (b) Find $A \cap \mathbb{W}$, $A \cap \mathbb{Z}$ and $A \cap \mathbb{P}$.
4. What is another name for $\mathbb{N} \cup \mathbb{Q}$? What about $\mathbb{Q} \cup \mathbb{P}$?

Solution.

1. To find a roster description for these sets, we need to list their elements. Starting with $P = \{2^n \mid n \in \mathbb{N}\}$, we substitute natural number values n into the formula 2^n . For $n = 1$ we get $2^1 = 2$, for $n = 2$ we get $2^2 = 4$, for $n = 3$ we get $2^3 = 8$ and for $n = 4$ we get $2^4 = 16$. Hence P describes the powers of 2, so a roster description for P is $P = \{2, 4, 8, 16, \dots\}$ where the ‘ \dots ’ indicates the that pattern continues.⁸

Proceeding in the same way, we generate elements in $E = \{2n \mid n \in \mathbb{Z}\}$ by plugging in integer values of n into the formula $2n$. Starting with $n = 0$ we obtain $2(0) = 0$. For $n = 1$ we get $2(1) = 2$, for $n = -1$ we get $2(-1) = -2$ for $n = 2$, we get $2(2) = 4$ and for $n = -2$ we get $2(-2) = -4$. As n moves through the integers, $2n$ produces all of the *even* integers.⁹ A roster description for E is $E = \{0, \pm 2, \pm 4, \dots\}$.

2. One way to verbally describe S is to say that S is the ‘set of all squares of real numbers’. While this isn’t incorrect, we’d like to take this opportunity to delve a little deeper.¹⁰ What makes the set $S = \{x^2 \mid x \in \mathbb{R}\}$ a little trickier to wrangle than the sets P or E above is that the dummy variable here, x , runs through all *real* numbers. Unlike the natural numbers or the integers, the real numbers cannot be listed in any methodical way.¹¹ Nevertheless, we can select some real numbers, square them and get a sense of what kind of numbers lie in S . For $x = -2$, $x^2 = (-2)^2 = 4$ so 4 is in S , as are $(\frac{3}{2})^2 = \frac{9}{4}$ and $(\sqrt{117})^2 = 117$. Even things like $(-\pi)^2$ and $(0.101001000100001\dots)^2$ are in S .

So suppose $s \in S$. What can be said about s ? We know there is some real number x so that $s = x^2$. Since $x^2 \geq 0$ for any real number x , we know $s \geq 0$. This tells us that everything in S is a non-negative real number.¹² This begs the question: are all of the non-negative real numbers in S ? Suppose n is a non-negative real number, that is, $n \geq 0$. If n were in S , there would be a real number x so that $x^2 = n$. As you may recall, we can solve $x^2 = n$ by ‘extracting square roots’: $x = \pm\sqrt{n}$. Since $n \geq 0$, \sqrt{n} is a real number.¹³ Moreover,

⁸This isn’t the most *precise* way to describe this set - it’s always dangerous to use ‘ \dots ’ since we assume that the pattern is clearly demonstrated and thus made evident to the reader. Formulas are more precise because the pattern is clear.

⁹This shouldn’t be too surprising, since an even integer is *defined* to be an integer multiple of 2.

¹⁰Think of this as an opportunity to stop and smell the mathematical roses.

¹¹This is a nontrivial statement. Interested readers are directed to a discussion of [Cantor’s Diagonal Argument](#).

¹²This means S is a subset of the non-negative real numbers.

¹³This is called the ‘square root closed’ property of the non-negative real numbers.

$(\sqrt{n})^2 = n$ so n is the square of a real number which means $n \in S$. Hence, S is the set of non-negative real numbers.

3. (a) The set A contains no natural numbers.¹⁴ Clearly, $\frac{4}{5}$ is a rational number as is -117 (which can be written as $\frac{-117}{1}$). It's the last two numbers listed in A , $0.20\overline{2002}$ and $0.202002000200002\dots$, that warrant some discussion. First, recall that the 'line' over the digits 2002 in $0.20\overline{2002}$ (called the vinculum) indicates that these digits repeat, so it is a rational number.¹⁵ As for the number $0.202002000200002\dots$, the ' \dots ' indicates the pattern of adding an extra '0' followed by a '2' is what defines this real number. Despite the fact there is a *pattern* to this decimal, this decimal is *not repeating*, so it is not a rational number - it is, in fact, an irrational number. All of the elements of A are real numbers, since all of them can be expressed as decimals (remember that $\frac{4}{5} = 0.8$).
- (b) The set $A \cap \mathbb{W} = \{x \mid x \in A \text{ and } x \in \mathbb{W}\}$ is another way of saying we are looking for the set of numbers in A which are whole numbers. Since A contains no whole numbers, $A \cap \mathbb{W} = \emptyset$. Similarly, $A \cap \mathbb{Z}$ is looking for the set of numbers in A which are integers. Since -117 is the only integer in A , $A \cap \mathbb{Z} = \{-117\}$. As for the set $A \cap \mathbb{P}$, as discussed in part (a), the number $0.202002000200002\dots$ is irrational, so $A \cap \mathbb{P} = \{0.202002000200002\dots\}$.
4. The set $\mathbb{N} \cup \mathbb{Q} = \{x \mid x \in \mathbb{N} \text{ or } x \in \mathbb{Q}\}$ is the union of the set of natural numbers with the set of rational numbers. Since every natural number is a rational number, \mathbb{N} doesn't contribute any new elements to \mathbb{Q} , so $\mathbb{N} \cup \mathbb{Q} = \mathbb{Q}$.¹⁶ For the set $\mathbb{Q} \cup \mathbb{P}$, we note that every real number is either rational or not, hence $\mathbb{Q} \cup \mathbb{P} = \mathbb{R}$, pretty much by the definition of the set \mathbb{P} . \square

As you may recall, we often visualize the set of real numbers \mathbb{R} as a line where each point on the line corresponds to one and only one real number. Given two different real numbers a and b , we write $a < b$ if a is located to the left of b on the number line, as shown below.



The real number line with two numbers a and b where $a < b$.

While this notion seems innocuous, it is worth pointing out that this convention is rooted in two deep properties of real numbers. The first property is that \mathbb{R} is complete. This means that there are no 'holes' or 'gaps' in the real number line.¹⁷ Another way to think about this is that if you choose any two distinct (different) real numbers, and look between them, you'll find a solid line segment (or interval) consisting of infinitely many real numbers. The next result tells us what types of numbers we can expect to find.

¹⁴Carl was tempted to include $0.\overline{9}$ in the set A , but thought better of it.

¹⁵So $0.20\overline{2002} = 0.20200220022002\dots$

¹⁶In fact, anytime $A \subseteq B$, $A \cup B = B$ and vice-versa. See the exercises.

¹⁷Alas, this intuitive feel for what it means to be 'complete' is as good as it gets at this level. Completeness does get a much more precise meaning later in courses like Analysis and Topology.

Density Property of \mathbb{Q} and \mathbb{P} in \mathbb{R}

Between any two distinct real numbers, there is at least one rational number and irrational number. It then follows that between any two distinct real numbers there will be infinitely many rational and irrational numbers.

The root word ‘dense’ here communicates the idea that rationals and irrationals are ‘thoroughly mixed’ into \mathbb{R} . The reader is encouraged to think about how one would find both a rational and an irrational number between, say, 0.9999 and 1. Once you’ve done that, try doing the same thing for the numbers $0.\bar{9}$ and 1. (‘Try’ is the operative word, here.)

The second property \mathbb{R} possesses that lets us view it as a line is that the set is **totally ordered**. This means that given any two real numbers a and b , either $a < b$, $a > b$ or $a = b$ which allows us to arrange the numbers from least (left) to greatest (right). You may have heard this property given as the ‘Law of Trichotomy’.

Law of Trichotomy



If a and b are real numbers then exactly one of the following statements is true:

$$a < b$$

$$a > b$$



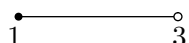
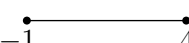
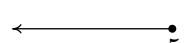



$$a = b$$

Segments of the real number line are called **intervals**. They play a huge role not only in this text but also in the Calculus curriculum so we need a concise way to describe them. We start by examining a few examples of the **interval notation** associated with some specific sets of numbers.

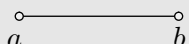
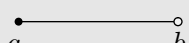
Set of Real Numbers	Interval Notation	Region on the Real Number Line
$\{x \mid 1 \leq x < 3\}$	$[1, 3)$	
$\{x \mid -1 \leq x \leq 4\}$	$[-1, 4]$	
$\{x \mid x \leq 5\}$	$(-\infty, 5]$	
$\{x \mid x > -2\}$	$(-2, \infty)$	

As you can glean from the table, for intervals with finite endpoints we start by writing ‘left endpoint, right endpoint’. We use square brackets, ‘[’ or ‘]’, if the endpoint is included in the interval. This corresponds to a ‘filled-in’ or ‘closed’ dot on the number line to indicate that the number is included in the set. Otherwise, we use parentheses, ‘(’ or ‘)’ that correspond to an ‘open’ circle which indicates that the endpoint is not part of the set. If the interval does not have finite endpoints, we use the symbol $-\infty$ to indicate that the interval extends indefinitely to the left and the symbol ∞ to indicate that the interval extends indefinitely to the right. Since infinity is a concept, and not a number, we always use parentheses when using these symbols in interval notation, and use the

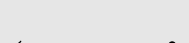
appropriate arrow to indicate that the interval extends indefinitely in one or both directions. We summarize all of the possible cases in one convenient table below.¹⁸

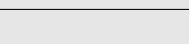
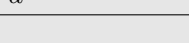
Interval Notation		
Let a and b be real numbers with $a < b$.		
Set of Real Numbers	Interval Notation	Region on the Real Number Line
$\{x \mid a < x < b\}$	(a, b)	
$\{x \mid a \leq x < b\}$	$[a, b)$	
$\{x \mid a < x \leq b\}$	$(a, b]$	
$\{x \mid a \leq x \leq b\}$	$[a, b]$	
$\{x \mid x < b\}$	$(-\infty, b)$	
$\{x \mid x \leq b\}$	$(-\infty, b]$	
$\{x \mid x > a\}$	(a, ∞)	
$\{x \mid x \geq a\}$	$[a, \infty)$	
\mathbb{R}	$(-\infty, \infty)$	

We close this section with an example that ties together several concepts presented earlier. Specifically, we demonstrate how to use interval notation along with the concepts of ‘union’ and ‘intersection’ to describe a variety of sets on the real number line.

Example 0.1.2.

1. Express the following sets of numbers using interval notation.

¹⁸The importance of understanding interval notation in Calculus cannot be overstated so please do yourself a favor and memorize this chart.

(a) $\{x \mid x \leq -2 \text{ or } x \geq 2\}$

(b) $\{x \mid x \neq 3\}$

(c) $\{x \mid x \neq \pm 3\}$

(d) $\{x \mid -1 < x \leq 3 \text{ or } x = 5\}$

2. Let $A = [-5, 3)$ and $B = (1, \infty)$. Find $A \cap B$ and $A \cup B$.

Solution.

1. (a) The best way to proceed here is to graph the set of numbers on the number line and glean the answer from it. The inequality $x \leq -2$ corresponds to the interval $(-\infty, -2]$ and the inequality $x \geq 2$ corresponds to the interval $[2, \infty)$. The ‘or’ in $\{x \mid x \leq -2 \text{ or } x \geq 2\}$ tells us that we are looking for the union of these two intervals, so our answer is $(-\infty, -2] \cup [2, \infty)$.

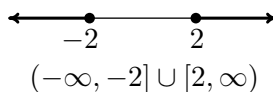

- (b) For the set $\{x \mid x \neq 3\}$, we shade the entire real number line except $x = 3$, where we leave an open circle. This divides the real number line into two intervals, $(-\infty, 3)$ and $(3, \infty)$. Since the values of x could be in one of these intervals *or* the other, we once again use the union symbol to get $\{x \mid x \neq 3\} = (-\infty, 3) \cup (3, \infty)$.

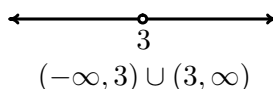

- (c) For the set $\{x \mid x \neq \pm 3\}$, we proceed as before and exclude both $x = 3$ and $x = -3$ from our set. (Do you remember what we said back on 6 about $x = \pm 3$?) This breaks the number line into *three* intervals, $(-\infty, -3)$, $(-3, 3)$ and $(3, \infty)$. Since the set describes real numbers which come from the first, second *or* third interval, we have $\{x \mid x \neq \pm 3\} = (-\infty, -3) \cup (-3, 3) \cup (3, \infty)$.

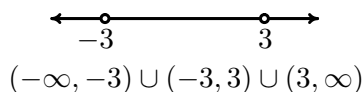

- (d) Graphing the set $\{x \mid -1 < x \leq 3 \text{ or } x = 5\}$ yields the interval $(-1, 3]$ along with the single number 5. While we *could* express this single point as $[5, 5]$, it is customary to write a single point as a ‘singleton set’, so in our case we have the set $\{5\}$. Thus our final answer is $\{x \mid -1 < x \leq 3 \text{ or } x = 5\} = (-1, 3] \cup \{5\}$.

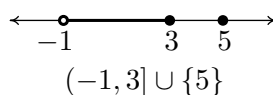

2. We start by graphing $A = [-5, 3)$ and $B = (1, \infty)$ on the number line. To find $A \cap B$, we need to find the numbers in common to both A and B , in other words, the overlap of the two intervals. Clearly, everything between 1 and 3 is in both A and B . However, since 1 is in A but not in B , 1 is not in the intersection. Similarly, since 3 is in B but not in A , it isn't in the intersection either. Hence, $A \cap B = (1, 3)$. To find $A \cup B$, we need to find the numbers in at least one of A or B . Graphically, we shade A and B along with it. Notice here that even though 1 isn't in B , it is in A , so it's the union along with all the other elements of A between -5 and 1. A similar argument goes for the inclusion of 3 in the union. The result of shading both A and B together gives us $A \cup B = [-5, \infty)$.

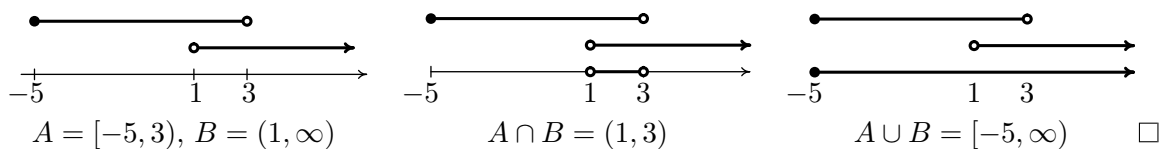

0.1.3 EXERCISES

1. Find a verbal description for $O = \{2n - 1 \mid n \in \mathbb{N}\}$
2. Find a roster description for $X = \{z^2 \mid z \in \mathbb{Z}\}$
3. Let $A = \left\{ -3, -1.02, -\frac{3}{5}, 0.57, 1.\overline{23}, \sqrt{3}, 5.2020020002\dots, \frac{20}{10}, 117 \right\}$
 - (a) List the elements of A which are natural numbers.
 - (b) List the elements of A which are irrational numbers.
 - (c) Find $A \cap \mathbb{Z}$
 - (d) Find $A \cap \mathbb{Q}$
4. Fill in the chart below.

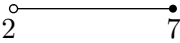
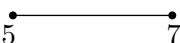
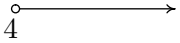
Set of Real Numbers	Interval Notation	Region on the Real Number Line
$\{x \mid -1 \leq x < 5\}$		
	$[0, 3)$	
		
$\{x \mid -5 < x \leq 0\}$		
	$(-3, 3)$	
		
$\{x \mid x \leq 3\}$		
	$(-\infty, 9)$	
		
$\{x \mid x \geq -3\}$		

In Exercises 5 - 10, find the indicated intersection or union and simplify if possible. Express your answers in interval notation.

5. $(-1, 5] \cap [0, 8)$

6. $(-1, 1) \cup [0, 6]$

7. $(-\infty, 4] \cap (0, \infty)$

8. $(-\infty, 0) \cap [1, 5]$

9. $(-\infty, 0) \cup [1, 5]$

10. $(-\infty, 5] \cap [5, 8)$

In Exercises 11 - 22, write the set using interval notation.

11. $\{x \mid x \neq 5\}$

12. $\{x \mid x \neq -1\}$

13. $\{x \mid x \neq -3, 4\}$

14. $\{x \mid x \neq 0, 2\}$

15. $\{x \mid x \neq 2, -2\}$

16. $\{x \mid x \neq 0, \pm 4\}$

17. $\{x \mid x \leq -1 \text{ or } x \geq 1\}$

18. $\{x \mid x < 3 \text{ or } x \geq 2\}$

19. $\{x \mid x \leq -3 \text{ or } x > 0\}$

20. $\{x \mid x \leq 5 \text{ or } x = 6\}$

21. $\{x \mid x > 2 \text{ or } x = \pm 1\}$

22. $\{x \mid -3 < x < 3 \text{ or } x = 4\}$

For Exercises 23 - 28, use the blank Venn Diagram below A , B , and C as a guide for you to shade the following sets.

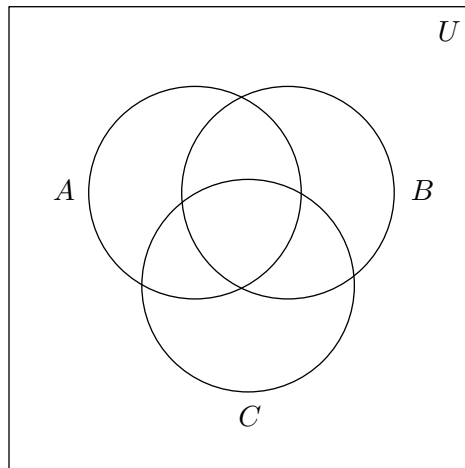

23. $A \cup C$

24. $B \cap C$

25. $(A \cup B) \cup C$

26. $(A \cap B) \cap C$







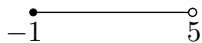
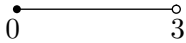

27. $A \cap (B \cup C)$

28. $(A \cap B) \cup (A \cap C)$

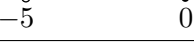
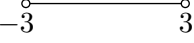
29. Explain how your answers to problems 27 and 28 show $A \cap (B \cup C) = (A \cap B) \cup (A \cap C)$. Phrased differently, this shows ‘intersection *distributes* over union.’ Discuss with your classmates if ‘union’ distributes over ‘intersection.’ Use a Venn Diagram to support your answer.

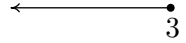
0.1.4 ANSWERS

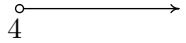
1. O is the odd natural numbers.
2. $X = \{0, 1, 4, 9, 16, \dots\}$
3. (a) $\frac{20}{10} = 2$ and 117
 (b) $\sqrt{3}$ and 5.2020020002
 (c) $\left\{-3, \frac{20}{10}, 117\right\}$
 (d) $\left\{-3, -1.02, -\frac{3}{5}, 0.57, 1.\overline{23}, \frac{20}{10}, 117\right\}$
- 4.

Set of Real Numbers	Interval Notation	Region on the Real Number Line
$\{x \mid -1 \leq x < 5\}$	$[-1, 5)$	
$\{x \mid 0 \leq x < 3\}$	$[0, 3)$	
$\{x \mid 2 < x \leq 7\}$	$(2, 7]$	
$\{x \mid -5 < x \leq 0\}$	$(-5, 0]$	
$\{x \mid -3 < x < 3\}$	$(-3, 3)$	
$\{x \mid 5 \leq x \leq 7\}$	$[5, 7]$	
$\{x \mid x \leq 3\}$	$(-\infty, 3]$	
$\{x \mid x < 9\}$	$(-\infty, 9)$	
$\{x \mid x > 4\}$	$(4, \infty)$	
$\{x \mid x \geq -3\}$	$[-3, \infty)$	

5. $(-1, 5] \cap [0, 8) = [0, 5]$

6. $(-1, 1) \cup [0, 6] = (-1, 6]$

7. $(-\infty, 4] \cap (0, \infty) = (0, 4]$

8. $(-\infty, 0) \cap [1, 5] = \emptyset$

9. $(-\infty, 0) \cup [1, 5] = (-\infty, 0) \cup [1, 5]$

10. $(-\infty, 5] \cap [5, 8) = \{5\}$

11. $(-\infty, 5) \cup (5, \infty)$

12. $(-\infty, -1) \cup (-1, \infty)$

13. $(-\infty, -3) \cup (-3, 4) \cup (4, \infty)$

14. $(-\infty, 0) \cup (0, 2) \cup (2, \infty)$

15. $(-\infty, -2) \cup (-2, 2) \cup (2, \infty)$

16. $(-\infty, -4) \cup (-4, 0) \cup (0, 4) \cup (4, \infty)$

17. $(-\infty, -1] \cup [1, \infty)$

18. $(-\infty, \infty)$

19. $(-\infty, -3] \cup (0, \infty)$

20. $(-\infty, 5] \cup \{6\}$

21. $\{-1\} \cup \{1\} \cup (2, \infty)$

22. $(-3, 3) \cup \{4\}$

23. $A \cup C$

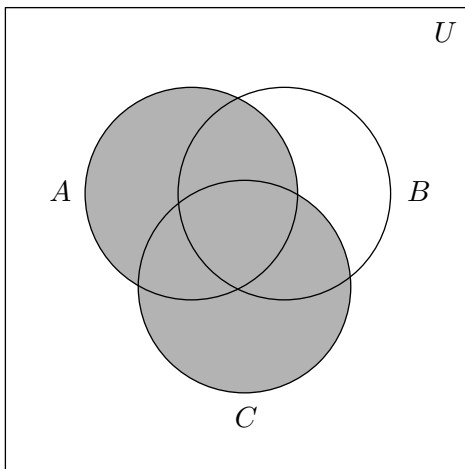

24. $B \cap C$

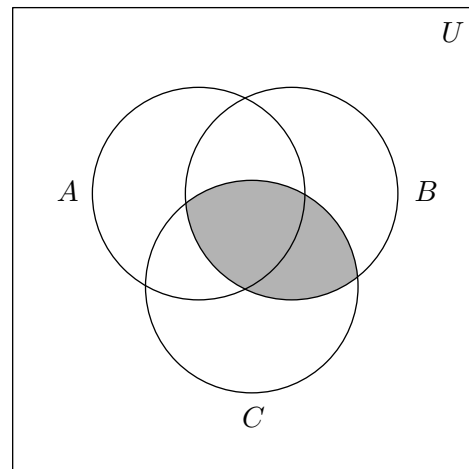

25. $(A \cup B) \cup C$

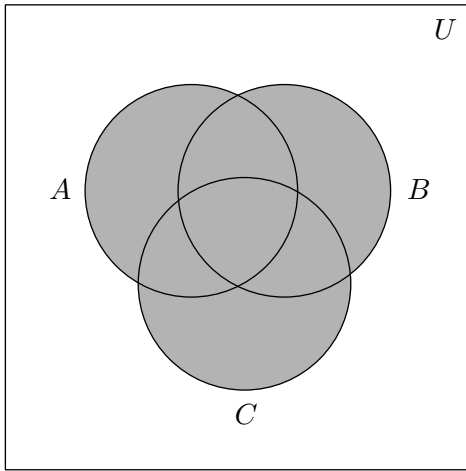

26. $(A \cap B) \cap C$

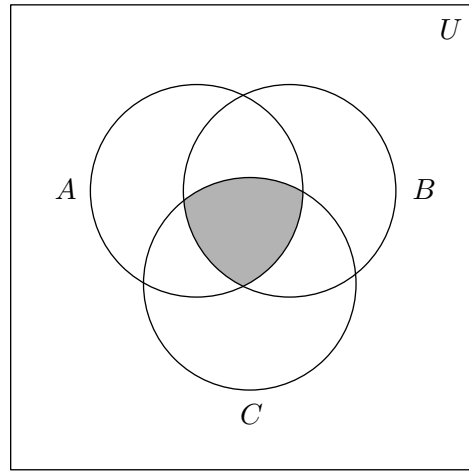

27. $A \cap (B \cup C)$

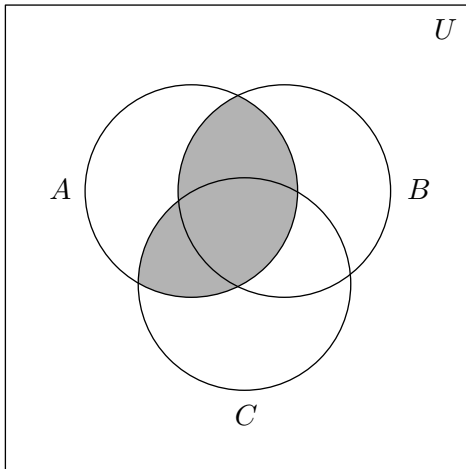

28. $(A \cap B) \cup (A \cap C)$

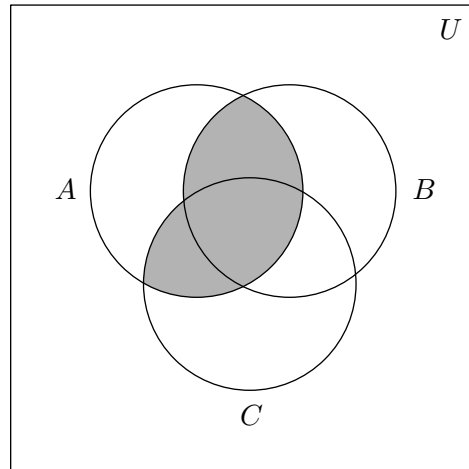

29. Yes, $A \cup (B \cap C) = (A \cup B) \cap (A \cup C)$.

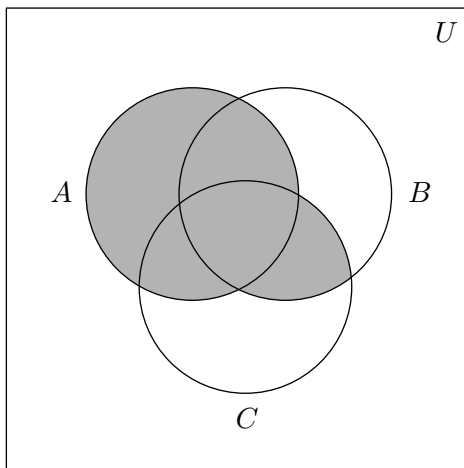

0.2 REAL NUMBER ARITHMETIC

In this section we list the properties of real number arithmetic. This is meant to be a succinct, targeted review so we'll resist the temptation to wax poetic about these axioms and their subtleties and refer the interested reader to a more formal course in Abstract Algebra. There are two (primary) operations one can perform with real numbers: addition and multiplication.

Properties of Real Number Addition

- **Closure:** For all real numbers a and b , $a + b$ is also a real number.
- **Commutativity:** For all real numbers a and b , $a + b = b + a$.
- **Associativity:** For all real numbers a , b and c , $a + (b + c) = (a + b) + c$.
- **Identity:** There is a real number '0' so that for all real numbers a , $a + 0 = a$.
- **Inverse:** For all real numbers a , there is a real number $-a$ such that $a + (-a) = 0$.
- **Definition of Subtraction:** For all real numbers a and b , $a - b = a + (-b)$.

Next, we give real number multiplication a similar treatment. Recall that we may denote the product of two real numbers a and b a variety of ways: ab , $a \cdot b$, $a(b)$, $(a)(b)$ and so on. We'll refrain from using $a \times b$ for real number multiplication in this text with one notable exception in Definition 0.7.

Properties of Real Number Multiplication

- **Closure:** For all real numbers a and b , ab is also a real number.
- **Commutativity:** For all real numbers a and b , $ab = ba$.
- **Associativity:** For all real numbers a , b and c , $a(bc) = (ab)c$.
- **Identity:** There is a real number '1' so that for all real numbers a , $a \cdot 1 = a$.
- **Inverse:** For all real numbers $a \neq 0$, there is a real number $\frac{1}{a}$ such that $a \left(\frac{1}{a}\right) = 1$.
- **Definition of Division:** For all real numbers a and $b \neq 0$, $a \div b = \frac{a}{b} = a \left(\frac{1}{b}\right)$.

While most students and some faculty tend to skip over these properties or give them a cursory glance at best,¹ it is important to realize that the properties stated above are what drive the symbolic manipulation for all of Algebra. When listing a tally of more than two numbers, $1 + 2 + 3$ for example, we don't need to specify the order in which those numbers are added. Notice though, try as we might, we can add only two numbers at a time and it is the associative property of

¹Not unlike how Carl approached all the Elven poetry in The Lord of the Rings.

addition which assures us that we could organize this sum as $(1 + 2) + 3$ or $1 + (2 + 3)$. This brings up a note about ‘grouping symbols’. Recall that parentheses and brackets are used in order to specify which operations are to be performed first. In the absence of such grouping symbols, multiplication (and hence division) is given priority over addition (and hence subtraction). For example, $1 + 2 \cdot 3 = 1 + 6 = 7$, but $(1 + 2) \cdot 3 = 3 \cdot 3 = 9$. As you may recall, we can ‘distribute’ the 3 across the addition if we really wanted to do the multiplication first: $(1 + 2) \cdot 3 = 1 \cdot 3 + 2 \cdot 3 = 3 + 6 = 9$. More generally, we have the following.

The Distributive Property and Factoring

For all real numbers a , b and c :

- **Distributive Property:** $a(b + c) = ab + ac$ and $(a + b)c = ac + bc$.
- **Factoring:**^a $ab + ac = a(b + c)$ and $ac + bc = (a + b)c$.

^aOr, as Carl calls it, ‘reading the Distributive Property from right to left.’

It is worth pointing out that we didn’t really need to list the Distributive Property both for $a(b + c)$ (distributing from the left) and $(a + b)c$ (distributing from the right), since the commutative property of multiplication gives us one from the other. Also, ‘factoring’ really is the same equation as the distributive property, just read from right to left. These are the first of many redundancies in this section, and they exist in this review section for one reason only - in our experience, many students *see* these things differently so we will list them as such.

It is hard to overstate the importance of the Distributive Property. For example, in the expression $5(2 + x)$, without knowing the value of x , we cannot perform the addition inside the parentheses first; we must rely on the distributive property here to get $5(2 + x) = 5 \cdot 2 + 5 \cdot x = 10 + 5x$. The Distributive Property is also responsible for combining ‘like terms’. Why is $3x + 2x = 5x$? Because $3x + 2x = (3 + 2)x = 5x$.

We continue our review with summaries of other properties of arithmetic, each of which can be derived from the properties listed above. First up are properties of the additive identity 0.

Properties of Zero

Suppose a and b are real numbers.

- **Zero Product Property:** $ab = 0$ if and only if $a = 0$ or $b = 0$ (or both)

Note: This not only says that $0 \cdot a = 0$ for any real number a , it also says that the *only* way to get an answer of ‘0’ when multiplying two real numbers is to have one (or both) of the numbers be ‘0’ in the first place.

- **Zeros in Fractions:** If $a \neq 0$, $\frac{0}{a} = 0 \cdot \left(\frac{1}{a}\right) = 0$.

Note: The quantity $\frac{a}{0}$ is undefined.^a

^aThe expression $\frac{0}{0}$ is technically an ‘indeterminant form’ as opposed to being strictly ‘undefined’ meaning that with Calculus we can make some sense of it in certain situations. We’ll talk more about this in Chapter 4.

The Zero Product Property drives most of the equation solving algorithms in Algebra because it allows us to take complicated equations and reduce them to simpler ones. For example, you may recall that one way to solve $x^2 + x - 6 = 0$ is by factoring² the left hand side of this equation to get $(x - 2)(x + 3) = 0$. From here, we apply the Zero Product Property and set each factor equal to zero. This yields $x - 2 = 0$ or $x + 3 = 0$ so $x = 2$ or $x = -3$. This application to solving equations leads, in turn, to some deep and profound structure theorems in Chapter 3.

Next up is a review of the arithmetic of ‘negatives’. On page 18 we first introduced the dash which we all recognize as the ‘negative’ symbol in terms of the additive inverse. For example, the number -3 (read ‘negative 3’) is defined so that $3 + (-3) = 0$. We then defined subtraction using the concept of the additive inverse again so that, for example, $5 - 3 = 5 + (-3)$. In this text we do not distinguish typographically between the dashes in the expressions ‘ $5 - 3$ ’ and ‘ -3 ’ even though they are mathematically quite different.³ In the expression ‘ $5 - 3$,’ the dash is a *binary* operation (that is, an operation requiring *two* numbers) whereas in ‘ -3 ,’ the dash is a *unary* operation (that is, an operation requiring only one number). You might ask, ‘Who cares?’ Your calculator does - that’s who! In the text we can write $-3 - 3 = -6$ but that will not work in your calculator. Instead you’d need to type $\overset{-}{3} - 3$ to get -6 where the first dash comes from the ‘+/-’ key.

²Don’t worry. We’ll review this in due course. And, yes, this is our old friend the Distributive Property!

³We’re not just being lazy here. We looked at many of the big publishers’ Precalculus books and none of them use different dashes, either.

Properties of Negatives

Given real numbers a and b we have the following.

- **Additive Inverse Properties:** $-a = (-1)a$ and $-(-a) = a$
- **Products of Negatives:** $(-a)(-b) = ab$.
- **Negatives and Products:** $-ab = -(ab) = (-a)b = a(-b)$.
- **Negatives and Fractions:** If b is nonzero, $-\frac{a}{b} = \frac{-a}{b} = \frac{a}{-b}$ and $\frac{-a}{-b} = \frac{a}{b}$.
- **‘Distributing’ Negatives:** $-(a + b) = -a - b$ and $-(a - b) = -a + b = b - a$.
- **‘Factoring’ Negatives:**^a $-a - b = -(a + b)$ and $b - a = -(a - b)$.

^aOr, as Carl calls it, reading ‘Distributing’ Negatives from right to left.

An important point here is that when we ‘distribute’ negatives, we do so across addition or subtraction only. This is because we are really distributing a factor of -1 across each of these terms: $-(a + b) = (-1)(a + b) = (-1)(a) + (-1)(b) = (-a) + (-b) = -a - b$. Negatives do not ‘distribute’ across multiplication: $-(2 \cdot 3) \neq (-2) \cdot (-3)$. Instead, $-(2 \cdot 3) = (-2) \cdot (3) = (2) \cdot (-3) = -6$. The same sort of thing goes for fractions: $-\frac{3}{5}$ can be written as $\frac{-3}{5}$ or $\frac{3}{-5}$, but not $\frac{-3}{-5}$. Speaking of fractions, we now review their arithmetic.

Properties of Fractions

Suppose a , b , c and d are real numbers. Assume them to be nonzero whenever necessary; for example, when they appear in a denominator.

- **Identity Properties:** $a = \frac{a}{1}$ and $\frac{a}{a} = 1$.
- **Fraction Equality:** $\frac{a}{b} = \frac{c}{d}$ if and only if $ad = bc$.
- **Multiplication of Fractions:** $\frac{a}{b} \cdot \frac{c}{d} = \frac{ac}{bd}$. In particular: $\frac{a}{b} \cdot c = \frac{a}{b} \cdot \frac{c}{1} = \frac{ac}{b}$

Note: A common denominator is **not** required to **multiply** fractions!

- **Division^a of Fractions:** $\frac{a}{b} \div \frac{c}{d} = \frac{a}{b} \cdot \frac{d}{c} = \frac{ad}{bc}$.

In particular: $1 \div \frac{a}{b} = \frac{b}{a}$ and $\frac{a}{b} \div c = \frac{a}{b} \div \frac{c}{1} = \frac{a}{b} \cdot \frac{1}{c} = \frac{a}{bc}$

Note: A common denominator is **not** required to **divide** fractions!

- **Addition and Subtraction of Fractions:** $\frac{a}{b} \pm \frac{c}{b} = \frac{a \pm c}{b}$.

Note: A common denominator **is** required to **add or subtract** fractions!

- **Equivalent Fractions:** $\frac{a}{b} = \frac{ad}{bd}$, since $\frac{a}{b} = \frac{a}{b} \cdot 1 = \frac{a}{b} \cdot \frac{d}{d} = \frac{ad}{bd}$

Note: The *only* way to change the denominator is to multiply both it and the numerator by the same nonzero value because we are, in essence, multiplying the fraction by 1.

- **‘Reducing’^b Fractions:** $\frac{ad}{bd} = \frac{a}{b}$, since $\frac{ad}{bd} = \frac{a}{b} \cdot \frac{d}{d} = \frac{a}{b} \cdot 1 = \frac{a}{b}$.

In particular, $\frac{ab}{b} = a$ since $\frac{ab}{b} = \frac{ab}{1 \cdot b} = \frac{a\cancel{b}}{1 \cdot \cancel{b}} = \frac{a}{1} = a$ and $\frac{b-a}{a-b} = \frac{(-1)(\cancel{a-b})}{(\cancel{a-b})} = -1$.

Note: We may only cancel common **factors** from both numerator and denominator.

^aThe old ‘invert and multiply’ or ‘fraction gymnastics’ play.

^bOr ‘Canceling’ Common Factors - this is really just reading the previous property ‘from right to left’.

Students make so many mistakes with fractions that we feel it is necessary to pause a moment in the narrative and offer you the following example.

Example 0.2.1. Perform the indicated operations and simplify. By ‘simplify’ here, we mean to have the final answer written in the form $\frac{a}{b}$ where a and b are integers which have no common factors. Said another way, we want $\frac{a}{b}$ in ‘lowest terms’.

$$\begin{array}{llll}
1. \frac{1}{4} + \frac{6}{7} & 2. \frac{5}{12} - \left(\frac{47}{30} - \frac{7}{3}\right) & 3. \frac{\frac{7}{3-5} - \frac{7}{3-5.21}}{5-5.21} & 4. \frac{\frac{12}{5} - \frac{7}{24}}{1 + \left(\frac{12}{5}\right)\left(\frac{7}{24}\right)} \\
5. \frac{(2(2)+1)(-3-(-3))-5(4-7)}{4-2(3)} & 6. \left(\frac{3}{5}\right)\left(\frac{5}{13}\right) - \left(\frac{4}{5}\right)\left(-\frac{12}{13}\right) & &
\end{array}$$

Solution.

1. It may seem silly to start with an example this basic but experience has taught us not to take much for granted. We start by finding the lowest common denominator and then we rewrite the fractions using that new denominator. Since 4 and 7 are **relatively prime**, meaning they have no factors in common, the lowest common denominator is $4 \cdot 7 = 28$.

$$\begin{aligned}
\frac{1}{4} + \frac{6}{7} &= \frac{1}{4} \cdot \frac{7}{7} + \frac{6}{7} \cdot \frac{4}{4} && \text{Equivalent Fractions} \\
&= \frac{7}{28} + \frac{24}{28} && \text{Multiplication of Fractions} \\
&= \frac{31}{28} && \text{Addition of Fractions}
\end{aligned}$$

The result is in lowest terms because 31 and 28 are relatively prime so we're done.

2. We could begin with the subtraction in parentheses, namely $\frac{47}{30} - \frac{7}{3}$, and then subtract that result from $\frac{5}{12}$. It's easier, however, to first distribute the negative across the quantity in parentheses and then use the Associative Property to perform all of the addition and subtraction in one step.⁴ The lowest common denominator⁵ for all three fractions is 60.

$$\begin{aligned}
\frac{5}{12} - \left(\frac{47}{30} - \frac{7}{3}\right) &= \frac{5}{12} - \frac{47}{30} + \frac{7}{3} && \text{Distribute the Negative} \\
&= \frac{5}{12} \cdot \frac{5}{5} - \frac{47}{30} \cdot \frac{2}{2} + \frac{7}{3} \cdot \frac{20}{20} && \text{Equivalent Fractions} \\
&= \frac{25}{60} - \frac{94}{60} + \frac{140}{60} && \text{Multiplication of Fractions} \\
&= \frac{71}{60} && \text{Addition and Subtraction of Fractions}
\end{aligned}$$

The numerator and denominator are relatively prime so the fraction is in lowest terms and we have our final answer.

⁴See the remark on page 18 about how we add $1 + 2 + 3$.

⁵We could have used $12 \cdot 30 \cdot 3 = 1080$ as our common denominator but then the numerators would become unnecessarily large. It's best to use the *lowest* common denominator.

3. What we are asked to simplify in this problem is known as a ‘complex’ or ‘compound’ fraction. Simply put, we have fractions within a fraction.⁶ The longest division line⁷ acts as a grouping symbol, quite literally dividing the compound fraction into a numerator (containing fractions) and a denominator (which in this case does not contain fractions). The first step to simplifying a compound fraction like this one is to see if you can simplify the little fractions inside it. To that end, we clean up the fractions in the numerator as follows.

$$\begin{aligned} \frac{\frac{7}{3-5} - \frac{7}{3-5.21}}{5-5.21} &= \frac{\frac{7}{-2} - \frac{7}{-2.21}}{-0.21} \\ &= \frac{-\left(-\frac{7}{2} + \frac{7}{2.21}\right)}{0.21} && \text{Properties of Negatives} \\ &= \frac{\frac{7}{2} - \frac{7}{2.21}}{0.21} && \text{Distribute the Negative} \end{aligned}$$

We are left with a compound fraction with decimals. We could replace 2.21 with $\frac{221}{100}$ but that would make a mess.⁸ It’s better in this case to eliminate the decimal by multiplying the numerator and denominator of the fraction with the decimal in it by 100 (since $2.21 \cdot 100 = 221$ is an integer) as shown below.

$$\frac{\frac{7}{2} - \frac{7}{2.21}}{0.21} = \frac{\frac{7}{2} - \frac{7 \cdot 100}{2.21 \cdot 100}}{0.21} = \frac{\frac{7}{2} - \frac{700}{221}}{0.21}$$

We now perform the subtraction in the numerator and replace 0.21 with $\frac{21}{100}$ in the denominator. This will leave us with one fraction divided by another fraction. We finish by performing the ‘division by a fraction is multiplication by the reciprocal’ trick and then cancel any factors that we can.

$$\begin{aligned} \frac{\frac{7}{2} - \frac{700}{221}}{0.21} &= \frac{\frac{7}{2} \cdot \frac{221}{221} - \frac{700}{221} \cdot \frac{2}{2}}{\frac{21}{100}} = \frac{\frac{1547}{442} - \frac{1400}{442}}{\frac{21}{100}} \\ &= \frac{\frac{147}{442}}{\frac{21}{100}} = \frac{147}{442} \cdot \frac{100}{21} = \frac{14700}{9282} = \frac{350}{221} \end{aligned}$$

The last step comes from the factorizations $14700 = 42 \cdot 350$ and $9282 = 42 \cdot 221$.

4. We are given another compound fraction to simplify and this time both the numerator and denominator contain fractions. As before, the longest division line acts as a grouping symbol

⁶Fractionception, perhaps?

⁷Also called a ‘vinculum’.

⁸Try it if you don’t believe us.

to separate the numerator from the denominator.

$$\frac{\frac{12}{5} - \frac{7}{24}}{1 + \left(\frac{12}{5}\right)\left(\frac{7}{24}\right)} = \frac{\left(\frac{12}{5} - \frac{7}{24}\right)}{\left(1 + \left(\frac{12}{5}\right)\left(\frac{7}{24}\right)\right)}$$

Hence, one way to proceed is as before: simplify the numerator and the denominator then perform the ‘division by a fraction is the multiplication by the reciprocal’ trick. While there is nothing wrong with this approach, we’ll use our Equivalent Fractions property to rid ourselves of the ‘compound’ nature of this fraction straight away. The idea is to multiply both the numerator and denominator by the lowest common denominator of each of the ‘smaller’ fractions - in this case, $24 \cdot 5 = 120$.

$$\begin{aligned} \frac{\left(\frac{12}{5} - \frac{7}{24}\right)}{\left(1 + \left(\frac{12}{5}\right)\left(\frac{7}{24}\right)\right)} &= \frac{\left(\frac{12}{5} - \frac{7}{24}\right) \cdot 120}{\left(1 + \left(\frac{12}{5}\right)\left(\frac{7}{24}\right)\right) \cdot 120} && \text{Equivalent Fractions} \\ &= \frac{\left(\frac{12}{5}\right)(120) - \left(\frac{7}{24}\right)(120)}{(1)(120) + \left(\frac{12}{5}\right)\left(\frac{7}{24}\right)(120)} && \text{Distributive Property} \\ &= \frac{\frac{12 \cdot 120}{5} - \frac{7 \cdot 120}{24}}{120 + \frac{12 \cdot 7 \cdot 120}{5 \cdot 24}} && \text{Multiply fractions} \\ &= \frac{\frac{12 \cdot 24 \cdot \cancel{5}}{\cancel{5}} - \frac{7 \cdot 5 \cdot \cancel{24}}{\cancel{24}}}{120 + \frac{12 \cdot 7 \cdot \cancel{5} \cdot \cancel{24}}{\cancel{5} \cdot \cancel{24}}} && \text{Factor and cancel} \\ &= \frac{(12 \cdot 24) - (7 \cdot 5)}{120 + (12 \cdot 7)} \\ &= \frac{288 - 35}{120 + 84} \\ &= \frac{253}{204} \end{aligned}$$

Since $253 = 11 \cdot 23$ and $204 = 2 \cdot 2 \cdot 3 \cdot 17$ have no common factors our result is in lowest terms which means we are done.

5. This fraction may look simpler than the one before it, but the negative signs and parentheses mean that we shouldn’t get complacent. Again we note that the division line here acts as a grouping symbol. That is,

$$\frac{(2(2) + 1)(-3 - (-3)) - 5(4 - 7)}{4 - 2(3)} = \frac{((2(2) + 1)(-3 - (-3)) - 5(4 - 7))}{(4 - 2(3))}$$

This means that we should simplify the numerator and denominator first, then perform the division last. We tend to what's in parentheses first, giving multiplication priority over addition and subtraction.

$$\begin{aligned} \frac{(2(2) + 1)(-3 - (-3)) - 5(4 - 7)}{4 - 2(3)} &= \frac{(4 + 1)(-3 + 3) - 5(-3)}{4 - 6} \\ &= \frac{(5)(0) + 15}{-2} \\ &= \frac{15}{-2} \\ &= -\frac{15}{2} \end{aligned} \quad \text{Properties of Negatives}$$

Since $15 = 3 \cdot 5$ and 2 have no common factors, we are done.

6. In this problem, we have multiplication and subtraction. Multiplication takes precedence so we perform it first. Recall that to multiply fractions, we do *not* need to obtain common denominators; rather, we multiply the corresponding numerators together along with the corresponding denominators. Like the previous example, we have parentheses and negative signs for added fun!

$$\begin{aligned} \left(\frac{3}{5}\right)\left(\frac{5}{13}\right) - \left(\frac{4}{5}\right)\left(-\frac{12}{13}\right) &= \frac{3 \cdot 5}{5 \cdot 13} - \frac{4 \cdot (-12)}{5 \cdot 13} && \text{Multiply fractions} \\ &= \frac{15}{65} - \frac{-48}{65} \\ &= \frac{15}{65} + \frac{48}{65} && \text{Properties of Negatives} \\ &= \frac{15 + 48}{65} && \text{Add numerators} \\ &= \frac{63}{65} \end{aligned}$$

Since $64 = 3 \cdot 3 \cdot 7$ and $65 = 5 \cdot 13$ have no common factors, our answer $\frac{63}{65}$ is in lowest terms and we are done. \square

Of the issues discussed in the previous set of examples none causes students more trouble than simplifying compound fractions. We presented two different methods for simplifying them: one in which we simplified the overall numerator and denominator and then performed the division and one in which we removed the compound nature of the fraction at the very beginning. We encourage the reader to go back and use both methods on each of the compound fractions presented. Keep in mind that when a compound fraction is encountered in the rest of the text it will usually be

simplified using only one method and we may not choose your favorite method. Feel free to use the other one in your notes.

Next, we review exponents and their properties. Recall that $2 \cdot 2 \cdot 2$ can be written as 2^3 because exponential notation expresses repeated multiplication. In the expression 2^3 , 2 is called the **base** and 3 is called the **exponent**. In order to generalize exponents from natural numbers to the integers, and eventually to rational and real numbers, it is helpful to think of the exponent as a count of the number of factors of the base we are multiplying by 1. For instance,

$$2^3 = 1 \cdot (\text{three factors of two}) = 1 \cdot (2 \cdot 2 \cdot 2) = 8.$$

From this, it makes sense that

$$2^0 = 1 \cdot (\text{zero factors of two}) = 1.$$

What about 2^{-3} ? The ‘-’ in the exponent indicates that we are ‘taking away’ three factors of two, essentially dividing by three factors of two. So,

$$2^{-3} = 1 \div (\text{three factors of two}) = 1 \div (2 \cdot 2 \cdot 2) = \frac{1}{2 \cdot 2 \cdot 2} = \frac{1}{8}.$$

We summarize the properties of integer exponents below.

Properties of Integer Exponents

Suppose a and b are nonzero real numbers and n and m are integers.

- **Product Rules:** $(ab)^n = a^n b^n$ and $a^n a^m = a^{n+m}$.
- **Quotient Rules:** $\left(\frac{a}{b}\right)^n = \frac{a^n}{b^n}$ and $\frac{a^n}{a^m} = a^{n-m}$.
- **Power Rule:** $(a^n)^m = a^{nm}$.
- **Negatives in Exponents:** $a^{-n} = \frac{1}{a^n}$.

In particular, $\left(\frac{a}{b}\right)^{-n} = \left(\frac{b}{a}\right)^n = \frac{b^n}{a^n}$ and $\frac{1}{a^{-n}} = a^n$.

- **Zero Powers:** $a^0 = 1$.

Note: The expression 0^0 is an indeterminate form.^a

- **Powers of Zero:** For any *natural* number n , $0^n = 0$.

Note: The expression 0^n for integers $n \leq 0$ is not defined.

^aSee the comment regarding ‘ $\frac{0}{0}$ ’ on page 19.

While it is important to state the Properties of Exponents, it is also equally important to take a moment to discuss one of the most common errors in Algebra. It is true that $(ab)^2 = a^2 b^2$ (which

some students refer to as ‘distributing’ the exponent to each factor) but you cannot do this sort of thing with addition. That is, in general, $(a + b)^2 \neq a^2 + b^2$. (For example, take $a = 3$ and $b = 4$.) The same goes for any other powers.

With exponents now in the mix, we can now state the Order of Operations Agreement.

Order of Operations Agreement

When evaluating an expression involving real numbers:

1. Evaluate any expressions in **p**arentheses (or other grouping symbols.)
2. Evaluate **e**xponents.
3. Evaluate **m**ultiplication and **d**ivision as you read from left to right.
4. Evaluate **a**ddition and **s**ubtraction as you read from left to right.

We note that there are many useful mnemonic device for remembering the order of operations.^a

^aOur favorite is ‘**P**lease **e**ntertain **m**y **d**ear **a**uld **S**asquatch.’

For example, $2 + 3 \cdot 4^2 = 2 + 3 \cdot 16 = 2 + 48 = 50$. Where students get into trouble is with things like -3^2 . If we think of this as $0 - 3^2$, then it is clear that we evaluate the exponent first: $-3^2 = 0 - 3^2 = 0 - 9 = -9$. In general, we interpret $-a^n = -(a^n)$. If we want the ‘negative’ to also be raised to a power, we must write $(-a)^n$ instead. To summarize, $-3^2 = -9$ but $(-3)^2 = 9$.

Of course, many of the ‘properties’ we’ve stated in this section can be viewed as ways to circumvent the order of operations. We’ve already seen how the distributive property allows us to simplify $5(2 + x)$ by performing the indicated multiplication **before** the addition that’s in parentheses. Similarly, consider trying to evaluate $2^{30172} \cdot 2^{-30169}$. The Order of Operations Agreement demands that the exponents be dealt with first, however, trying to compute 2^{30172} is a challenge, even for a calculator. One of the Product Rules of Exponents, however, allow us to rewrite this product, essentially performing the multiplication first, to get: $2^{30172-30169} = 2^3 = 8$.

Let’s take a break and enjoy another example.

Example 0.2.2. Perform the indicated operations and simplify.

$$1. \frac{(4 - 2)(2 \cdot 4) - (4)^2}{(4 - 2)^2}$$

$$2. 12(-5)(-5 + 3)^{-4} + 6(-5)^2(-4)(-5 + 3)^{-5}$$

$$3. \frac{\left(\frac{5 \cdot 3^{51}}{4^{36}}\right)}{\left(\frac{5 \cdot 3^{49}}{4^{34}}\right)}$$

$$4. \frac{2 \left(\frac{5}{12}\right)^{-1}}{1 - \left(\frac{5}{12}\right)^{-2}}$$

Solution.

1. We begin working inside parentheses then deal with the exponents before working through the other operations. As we saw in Example 0.2.1, the division here acts as a grouping symbol, so we save the division to the end.

$$\begin{aligned} \frac{(4-2)(2 \cdot 4) - (4)^2}{(4-2)^2} &= \frac{(2)(8) - (4)^2}{(2)^2} = \frac{(2)(8) - 16}{4} \\ &= \frac{16 - 16}{4} = \frac{0}{4} = 0 \end{aligned}$$

2. As before, we simplify what's in the parentheses first, then work our way through the exponents, multiplication, and finally, the addition.

$$\begin{aligned} 12(-5)(-5+3)^{-4} + 6(-5)^2(-4)(-5+3)^{-5} &= 12(-5)(-2)^{-4} + 6(-5)^2(-4)(-2)^{-5} \\ &= 12(-5) \left(\frac{1}{(-2)^4} \right) + 6(-5)^2(-4) \left(\frac{1}{(-2)^5} \right) \\ &= 12(-5) \left(\frac{1}{16} \right) + 6(25)(-4) \left(\frac{1}{-32} \right) \\ &= (-60) \left(\frac{1}{16} \right) + (-600) \left(\frac{1}{-32} \right) \\ &= \frac{-60}{16} + \left(\frac{-600}{-32} \right) \\ &= \frac{-15 \cdot \cancel{4}}{4 \cdot \cancel{4}} + \frac{-75 \cdot \cancel{8}}{-4 \cdot \cancel{8}} \\ &= \frac{-15}{4} + \frac{-75}{-4} \\ &= \frac{-15}{4} + \frac{75}{4} \\ &= \frac{-15 + 75}{4} \\ &= \frac{60}{4} \\ &= 15 \end{aligned}$$

3. The Order of Operations Agreement mandates that we work within each set of parentheses first, giving precedence to the exponents, then the multiplication, and, finally the division. The trouble with this approach is that the exponents are so large that computation becomes a trifle unwieldy. What we observe, however, is that the bases of the exponential expressions, 3 and 4, occur in both the numerator and denominator of the compound fraction, giving us hope that we can use some of the Properties of Exponents (the Quotient Rule, in particular) to help us out. Our first step here is to invert and multiply. We see immediately that the 5's

cancel after which we group the powers of 3 together and the powers of 4 together and apply the properties of exponents.

$$\begin{aligned} \frac{\left(\frac{5 \cdot 3^{51}}{4^{36}}\right)}{\left(\frac{5 \cdot 3^{49}}{4^{34}}\right)} &= \frac{5 \cdot 3^{51}}{4^{36}} \cdot \frac{4^{34}}{5 \cdot 3^{49}} = \frac{\cancel{5} \cdot 3^{51} \cdot 4^{34}}{\cancel{5} \cdot 3^{49} \cdot 4^{36}} = \frac{3^{51}}{3^{49}} \cdot \frac{4^{34}}{4^{36}} \\ &= 3^{51-49} \cdot 4^{34-36} = 3^2 \cdot 4^{-2} = 3^2 \cdot \left(\frac{1}{4^2}\right) \\ &= 9 \cdot \left(\frac{1}{16}\right) = \frac{9}{16} \end{aligned}$$

4. We have yet another instance of a compound fraction so our first order of business is to rid ourselves of the compound nature of the fraction like we did in Example 0.2.1. To do this, however, we need to tend to the exponents first so that we can determine what common denominator is needed to simplify the fraction.

$$\begin{aligned} \frac{2 \left(\frac{5}{12}\right)^{-1}}{1 - \left(\frac{5}{12}\right)^{-2}} &= \frac{2 \left(\frac{12}{5}\right)}{1 - \left(\frac{12}{5}\right)^2} = \frac{\left(\frac{24}{5}\right)}{1 - \left(\frac{12^2}{5^2}\right)} = \frac{\left(\frac{24}{5}\right)}{1 - \left(\frac{144}{25}\right)} \\ &= \frac{\left(\frac{24}{5}\right) \cdot 25}{\left(1 - \frac{144}{25}\right) \cdot 25} = \frac{\left(\frac{24 \cdot 5 \cdot \cancel{5}}{\cancel{5}}\right)}{\left(1 \cdot 25 - \frac{144 \cdot \cancel{25}}{\cancel{25}}\right)} = \frac{120}{25 - 144} \\ &= \frac{120}{-119} = -\frac{120}{119} \end{aligned}$$

Since 120 and 119 have no common factors, we are done. \square

One of the places where the properties of exponents play an important role is in the use of **Scientific Notation**. The basis for scientific notation is that since we use decimals (base ten numerals) to represent real numbers, we can adjust where the decimal point lies by multiplying by an appropriate power of 10. This allows scientists and engineers to focus in on the ‘significant’ digits⁹ of a number - the nonzero values - and adjust for the decimal places later. For instance, $-621 = -6.21 \times 10^2$ and $0.023 = 2.3 \times 10^{-2}$. Notice here that we revert to using the familiar ‘ \times ’ to indicate multiplication.¹⁰ In general, we arrange the real number so exactly one non-zero digit appears to the left of the decimal point. We make this idea precise in the following:

⁹Awesome pun!

¹⁰This is the ‘notable exception’ we alluded to earlier.

Definition 0.7. A real number is written in **Scientific Notation** if it has the form $\pm n.d_1d_2\dots \times 10^k$ where n is a natural number, d_1, d_2, \dots , are whole numbers, and k is an integer.

On calculators, scientific notation may appear using an ‘E’ or ‘EE’ as opposed to the \times symbol. For instance, while we will write 6.02×10^{23} in the text, the calculator may display 6.02 E 23 or 6.02 EE 23.

Example 0.2.3. Perform the indicated operations and simplify. Write your final answer in scientific notation, rounded to two decimal places.

$$1. \frac{(6.626 \times 10^{-34})(3.14 \times 10^9)}{1.78 \times 10^{23}} \qquad 2. (2.13 \times 10^{53})^{100}$$

Solution.

1. As mentioned earlier, the point of scientific notation is to separate out the ‘significant’ parts of a calculation and deal with the powers of 10 later. In that spirit, we separate out the powers of 10 in both the numerator and the denominator and proceed as follows

$$\begin{aligned} \frac{(6.626 \times 10^{-34})(3.14 \times 10^9)}{1.78 \times 10^{23}} &= \frac{(6.626)(3.14)}{1.78} \cdot \frac{10^{-34} \cdot 10^9}{10^{23}} \\ &= \frac{20.80564}{1.78} \cdot \frac{10^{-34+9}}{10^{23}} \\ &= 11.685\dots \cdot \frac{10^{-25}}{10^{23}} \\ &= 11.685\dots \times 10^{-25-23} \\ &= 11.685\dots \times 10^{-48} \end{aligned}$$

We are asked to write our final answer in scientific notation, rounded to two decimal places. To do this, we note that $11.685\dots = 1.1685\dots \times 10^1$, so

$$11.685\dots \times 10^{-48} = 1.1685\dots \times 10^1 \times 10^{-48} = 1.1685\dots \times 10^{1-48} = 1.1685\dots \times 10^{-47}$$

Our final answer, rounded to two decimal places, is 1.17×10^{-47} .

We could have done that whole computation on a calculator so why did we bother doing any of this by hand in the first place? The answer lies in the next example.

2. If you try to compute $(2.13 \times 10^{53})^{100}$ using most hand-held calculators, you’ll most likely get an ‘overflow’ error. It is possible, however, to use the calculator in combination with the properties of exponents to compute this number. Using properties of exponents, we get:

$$\begin{aligned} (2.13 \times 10^{53})^{100} &= (2.13)^{100} (10^{53})^{100} \\ &= (6.885\dots \times 10^{32}) (10^{53 \times 100}) \\ &= (6.885\dots \times 10^{32}) (10^{5300}) \\ &= 6.885\dots \times 10^{32} \cdot 10^{5300} \\ &= 6.885\dots \times 10^{5332} \end{aligned}$$

To two decimal places our answer is 6.88×10^{5332} . \square

We close our review of real number arithmetic with a discussion of roots and radical notation. Just as subtraction and division were defined in terms of the inverse of addition and multiplication, respectively, we define roots by undoing natural number exponents.

Definition 0.8. Let a be a real number and let n be a natural number. If n is odd, then the **principal n^{th} root** of a (denoted $\sqrt[n]{a}$) is the unique real number satisfying $(\sqrt[n]{a})^n = a$. If n is even, $\sqrt[n]{a}$ is defined similarly provided $a \geq 0$ and $\sqrt[n]{a} \geq 0$. The number n is called the **index** of the root and the the number a is called the **radicand**. For $n = 2$, we write \sqrt{a} instead of $\sqrt[2]{a}$.

The reasons for the added stipulations for even-indexed roots in Definition 0.8 can be found in the Properties of Negatives. First, for all real numbers, $x^{\text{even power}} \geq 0$, which means it is never negative. Thus if a is a *negative* real number, there are no real numbers x with $x^{\text{even power}} = a$. This is why if n is even, $\sqrt[n]{a}$ only exists if $a \geq 0$. The second restriction for even-indexed roots is that $\sqrt[n]{a} \geq 0$. This comes from the fact that $x^{\text{even power}} = (-x)^{\text{even power}}$, and we require $\sqrt[n]{a}$ to have just one value. So even though $2^4 = 16$ and $(-2)^4 = 16$, we require $\sqrt[4]{16} = 2$ and ignore -2 .

Dealing with odd powers is much easier. For example, $x^3 = -8$ has one and only one real solution, namely $x = -2$, which means not only does $\sqrt[3]{-8}$ exist, there is only one choice, namely $\sqrt[3]{-8} = -2$. Of course, when it comes to solving $x^{5213} = -117$, it's not so clear that there is one and only one real solution, let alone that the solution is $\sqrt[5213]{-117}$. Such pills are easier to swallow once we've thought a bit about such equations graphically,¹¹ and ultimately, these things come from the completeness property of the real numbers mentioned earlier.

We list properties of radicals below as a 'theorem' since they can be justified using the properties of exponents.

Theorem 0.1. Properties of Radicals: Let a and b be real numbers and let m and n be natural numbers. If $\sqrt[n]{a}$ and $\sqrt[n]{b}$ are real numbers, then

- **Product Rule:** $\sqrt[n]{ab} = \sqrt[n]{a} \sqrt[n]{b}$
- **Quotient Rule:** $\sqrt[n]{\frac{a}{b}} = \frac{\sqrt[n]{a}}{\sqrt[n]{b}}$, provided $b \neq 0$.
- **Power Rule:** $\sqrt[n]{a^m} = (\sqrt[n]{a})^m$

The proof of Theorem 5.6 is based on the definition of the principal n^{th} root and the Properties of Exponents. To establish the product rule, consider the following. If n is odd, then by definition $\sqrt[n]{ab}$ is the unique real number such that $(\sqrt[n]{ab})^n = ab$. Given that $(\sqrt[n]{a} \sqrt[n]{b})^n = (\sqrt[n]{a})^n (\sqrt[n]{b})^n = ab$ as well, it must be the case that $\sqrt[n]{ab} = \sqrt[n]{a} \sqrt[n]{b}$. If n is even, then $\sqrt[n]{ab}$ is the unique non-negative real number such that $(\sqrt[n]{ab})^n = ab$. Note that since n is even, $\sqrt[n]{a}$ and $\sqrt[n]{b}$ are also non-negative thus $\sqrt[n]{a} \sqrt[n]{b} \geq 0$ as well. Proceeding as above, we find that $\sqrt[n]{ab} = \sqrt[n]{a} \sqrt[n]{b}$. The quotient rule is

¹¹See Chapter 3.

proved similarly and is left as an exercise. The power rule results from repeated application of the product rule, so long as $\sqrt[n]{a}$ is a real number to start with.¹² We leave that as an exercise as well.

We pause here to point out one of the most common errors students make when working with radicals. Obviously $\sqrt{9} = 3$, $\sqrt{16} = 4$ and $\sqrt{9+16} = \sqrt{25} = 5$. Thus we can clearly see that $5 = \sqrt{25} = \sqrt{9+16} \neq \sqrt{9} + \sqrt{16} = 3+4 = 7$ because we all know that $5 \neq 7$. The authors urge you to never consider ‘distributing’ roots or exponents. It’s wrong and no good will come of it because in general $\sqrt[n]{a+b} \neq \sqrt[n]{a} + \sqrt[n]{b}$.

Since radicals have properties inherited from exponents, they are often written as such. We define rational exponents in terms of radicals in the box below.

Definition 0.9. Let a be a real number, let m be an integer and let n be a natural number.

- $a^{\frac{1}{n}} = \sqrt[n]{a}$ whenever $\sqrt[n]{a}$ is a real number.^a
- $a^{\frac{m}{n}} = (\sqrt[n]{a})^m = \sqrt[n]{a^m}$ whenever $\sqrt[n]{a}$ is a real number.

^aIf n is even we need $a \geq 0$.

It would make life really nice if the rational exponents defined in Definition 0.9 had all of the same properties that integer exponents have as listed on page 27 - but they don’t. Why not? Let’s look at an example to see what goes wrong. Consider the Product Rule which says that $(ab)^n = a^n b^n$ and let $a = -16$, $b = -81$ and $n = \frac{1}{4}$. Plugging the values into the Product Rule yields the equation $((-16)(-81))^{1/4} = (-16)^{1/4}(-81)^{1/4}$. The left side of this equation is $1296^{1/4}$ which equals 6 but the right side is undefined because neither root is a real number. Would it help if, when it comes to even roots (as signified by even denominators in the fractional exponents), we ensure that everything they apply to is non-negative? That works for some of the rules - we leave it as an exercise to see which ones - but does not work for the Power Rule.

Consider the expression $(a^{2/3})^{3/2}$. Applying the usual laws of exponents, we’d be tempted to simplify this as $(a^{2/3})^{3/2} = a^{\frac{2}{3} \cdot \frac{3}{2}} = a^1 = a$. However, if we substitute $a = -1$ and apply Definition 0.9, we find $(-1)^{2/3} = (\sqrt[3]{-1})^2 = (-1)^2 = 1$ so that $((-1)^{2/3})^{3/2} = 1^{3/2} = (\sqrt{1})^3 = 1^3 = 1$. Thus in this case we have $(a^{2/3})^{3/2} \neq a$ even though all of the roots were defined. It is true, however, that $(a^{3/2})^{2/3} = a$ and we leave this for the reader to show. The moral of the story is that when simplifying powers of rational exponents where the base is negative or worse, unknown, it’s usually best to rewrite them as radicals.¹³

Example 0.2.4. Perform the indicated operations and simplify.

$$1. \frac{-(-4) - \sqrt{(-4)^2 - 4(2)(-3)}}{2(2)}$$

¹²Otherwise we’d run into an interesting paradox.

¹³Much to Jeff’s chagrin. He’s fairly traditional and therefore doesn’t care much for radicals.

$$2. \frac{2 \left(\frac{\sqrt{3}}{3} \right)}{1 - \left(\frac{\sqrt{3}}{3} \right)^2}$$

$$3. (\sqrt[3]{-2} - \sqrt[3]{-54})^2$$

$$4. 2 \left(\frac{9}{4} - 3 \right)^{1/3} + 2 \left(\frac{9}{4} \right) \left(\frac{1}{3} \right) \left(\frac{9}{4} - 3 \right)^{-2/3}$$

Solution.

1. We begin in the numerator and note that the radical here acts a grouping symbol,¹⁴ so our first order of business is to simplify the radicand.

$$\begin{aligned} \frac{-(-4) - \sqrt{(-4)^2 - 4(2)(-3)}}{2(2)} &= \frac{-(-4) - \sqrt{16 - 4(2)(-3)}}{2(2)} \\ &= \frac{-(-4) - \sqrt{16 - 4(-6)}}{2(2)} \\ &= \frac{-(-4) - \sqrt{16 - (-24)}}{2(2)} \\ &= \frac{-(-4) - \sqrt{16 + 24}}{2(2)} \\ &= \frac{-(-4) - \sqrt{40}}{2(2)} \end{aligned}$$

As you may recall, 40 can be factored using a perfect square as $40 = 4 \cdot 10$ so we use the product rule of radicals to write $\sqrt{40} = \sqrt{4 \cdot 10} = \sqrt{4}\sqrt{10} = 2\sqrt{10}$. This lets us factor a ‘2’ out of both terms in the numerator, eventually allowing us to cancel it with a factor of 2 in the denominator.

$$\begin{aligned} \frac{-(-4) - \sqrt{40}}{2(2)} &= \frac{-(-4) - 2\sqrt{10}}{2(2)} = \frac{4 - 2\sqrt{10}}{2(2)} \\ &= \frac{2 \cdot 2 - 2\sqrt{10}}{2(2)} = \frac{2(2 - \sqrt{10})}{2(2)} \\ &= \frac{\cancel{2}(2 - \sqrt{10})}{\cancel{2}(2)} = \frac{2 - \sqrt{10}}{2} \end{aligned}$$

Since the numerator and denominator have no more common factors,¹⁵ we are done.

¹⁴The line extending horizontally from the square root symbol ‘√’ is, you guessed it, another vinculum.

¹⁵Do you see why we aren’t ‘canceling’ the remaining 2’s?

2. Once again we have a compound fraction, so we first simplify the exponent in the denominator to see which factor we'll need to multiply by in order to clean up the fraction.

$$\begin{aligned}
 \frac{2\left(\frac{\sqrt{3}}{3}\right)}{1-\left(\frac{\sqrt{3}}{3}\right)^2} &= \frac{2\left(\frac{\sqrt{3}}{3}\right)}{1-\left(\frac{(\sqrt{3})^2}{3^2}\right)} = \frac{2\left(\frac{\sqrt{3}}{3}\right)}{1-\left(\frac{3}{9}\right)} \\
 &= \frac{2\left(\frac{\sqrt{3}}{3}\right)}{1-\left(\frac{1\cdot\cancel{3}}{3\cdot\cancel{3}}\right)} = \frac{2\left(\frac{\sqrt{3}}{3}\right)}{1-\left(\frac{1}{3}\right)} \\
 &= \frac{2\left(\frac{\sqrt{3}}{3}\right)\cdot 3}{\left(1-\left(\frac{1}{3}\right)\right)\cdot 3} = \frac{2\cdot\sqrt{3}\cdot\cancel{3}}{\cancel{3}} \\
 &= \frac{2\sqrt{3}}{3-1} = \frac{\cancel{2}\sqrt{3}}{\cancel{2}} = \sqrt{3}
 \end{aligned}$$

3. Working inside the parentheses, we first encounter $\sqrt[3]{-2}$. While the -2 isn't a perfect cube,¹⁶ we may think of $-2 = (-1)(2)$. Since $(-1)^3 = -1$, -1 is a perfect cube, and we may write $\sqrt[3]{-2} = \sqrt[3]{(-1)(2)} = \sqrt[3]{-1}\sqrt[3]{2} = -\sqrt[3]{2}$. When it comes to $\sqrt[3]{54}$, we may write it as $\sqrt[3]{(-27)(2)} = \sqrt[3]{-27}\sqrt[3]{2} = -3\sqrt[3]{2}$. So,

$$\sqrt[3]{-2} - \sqrt[3]{-54} = -\sqrt[3]{2} - (-3\sqrt[3]{2}) = -\sqrt[3]{2} + 3\sqrt[3]{2}.$$

At this stage, we can simplify $-\sqrt[3]{2} + 3\sqrt[3]{2} = 2\sqrt[3]{2}$. You may remember this as being called 'combining like radicals,' but it is in fact just another application of the distributive property:

$$-\sqrt[3]{2} + 3\sqrt[3]{2} = (-1)\sqrt[3]{2} + 3\sqrt[3]{2} = (-1 + 3)\sqrt[3]{2} = 2\sqrt[3]{2}.$$

Putting all this together, we get:

$$\begin{aligned}
 (\sqrt[3]{-2} - \sqrt[3]{-54})^2 &= (-\sqrt[3]{2} + 3\sqrt[3]{2})^2 = (2\sqrt[3]{2})^2 \\
 &= 2^2(\sqrt[3]{2})^2 = 4\sqrt[3]{2^2} = 4\sqrt[3]{4}
 \end{aligned}$$

Since there are no perfect integer cubes which are factors of 4 (apart from 1, of course), we are done.

¹⁶Of an integer, that is!

4. We start working in parentheses and get a common denominator to subtract the fractions:

$$\frac{9}{4} - 3 = \frac{9}{4} - \frac{3 \cdot 4}{1 \cdot 4} = \frac{9}{4} - \frac{12}{4} = \frac{-3}{4}$$

Since the denominators in the fractional exponents are odd, we can proceed using the properties of exponents:

$$\begin{aligned} 2 \left(\frac{9}{4} - 3 \right)^{1/3} + 2 \left(\frac{9}{4} \right) \left(\frac{1}{3} \right) \left(\frac{9}{4} - 3 \right)^{-2/3} &= 2 \left(\frac{-3}{4} \right)^{1/3} + 2 \left(\frac{9}{4} \right) \left(\frac{1}{3} \right) \left(\frac{-3}{4} \right)^{-2/3} \\ &= 2 \left(\frac{(-3)^{1/3}}{(4)^{1/3}} \right) + 2 \left(\frac{9}{4} \right) \left(\frac{1}{3} \right) \left(\frac{4}{-3} \right)^{2/3} \\ &= 2 \left(\frac{(-3)^{1/3}}{(4)^{1/3}} \right) + 2 \left(\frac{9}{4} \right) \left(\frac{1}{3} \right) \left(\frac{(4)^{2/3}}{(-3)^{2/3}} \right) \\ &= \frac{2 \cdot (-3)^{1/3}}{4^{1/3}} + \frac{2 \cdot 9 \cdot 1 \cdot 4^{2/3}}{4 \cdot 3 \cdot (-3)^{2/3}} \\ &= \frac{2 \cdot (-3)^{1/3}}{4^{1/3}} + \frac{\cancel{2} \cdot 3 \cdot \cancel{3} \cdot 4^{2/3}}{2 \cdot \cancel{2} \cdot \cancel{3} \cdot (-3)^{2/3}} \\ &= \frac{2 \cdot (-3)^{1/3}}{4^{1/3}} + \frac{3 \cdot 4^{2/3}}{2 \cdot (-3)^{2/3}} \end{aligned}$$

At this point, we could start looking for common denominators but it turns out that these fractions reduce even further. Since $4 = 2^2$, $4^{1/3} = (2^2)^{1/3} = 2^{2/3}$. Similarly, $4^{2/3} = (2^2)^{2/3} = 2^{4/3}$. The expressions $(-3)^{1/3}$ and $(-3)^{2/3}$ contain negative bases so we proceed with caution and convert them back to radical notation to get: $(-3)^{1/3} = \sqrt[3]{-3} = -\sqrt[3]{3} = -3^{1/3}$ and $(-3)^{2/3} = (\sqrt[3]{-3})^2 = (-\sqrt[3]{3})^2 = (\sqrt[3]{3})^2 = 3^{2/3}$. Hence:

$$\begin{aligned} \frac{2 \cdot (-3)^{1/3}}{4^{1/3}} + \frac{3 \cdot 4^{2/3}}{2 \cdot (-3)^{2/3}} &= \frac{2 \cdot (-3^{1/3})}{2^{2/3}} + \frac{3 \cdot 2^{4/3}}{2 \cdot 3^{2/3}} \\ &= \frac{2^1 \cdot (-3^{1/3})}{2^{2/3}} + \frac{3^1 \cdot 2^{4/3}}{2^1 \cdot 3^{2/3}} \\ &= 2^{1-2/3} \cdot (-3^{1/3}) + 3^{1-2/3} \cdot 2^{4/3-1} \\ &= 2^{1/3} \cdot (-3^{1/3}) + 3^{1/3} \cdot 2^{1/3} \\ &= -2^{1/3} \cdot 3^{1/3} + 3^{1/3} \cdot 2^{1/3} \\ &= 0 \end{aligned}$$

□

0.2.1 EXERCISES

In Exercises 1 - 33, perform the indicated operations and simplify.

1. $5 - 2 + 3$
2. $5 - (2 + 3)$
3. $\frac{2}{3} - \frac{4}{7}$
4. $\frac{3}{8} + \frac{5}{12}$
5. $\frac{5 - 3}{-2 - 4}$
6. $\frac{2(-3)}{3 - (-3)}$
7. $\frac{2(3) - (4 - 1)}{2^2 + 1}$
8. $\frac{4 - 5.8}{2 - 2.1}$
9. $\frac{1 - 2(-3)}{5(-3) + 7}$
10. $\frac{5(3) - 7}{2(3)^2 - 3(3) - 9}$
11. $\frac{2((-1)^2 - 1)}{((-1)^2 + 1)^2}$
12. $\frac{(-2)^2 - (-2) - 6}{(-2)^2 - 4}$
13. $\frac{3 - \frac{4}{9}}{-2 - (-3)}$
14. $\frac{\frac{2}{3} - \frac{4}{5}}{4 - \frac{7}{10}}$
15. $\frac{2\left(\frac{4}{3}\right)}{1 - \left(\frac{4}{3}\right)^2}$
16. $\frac{1 - \left(\frac{5}{3}\right)\left(\frac{3}{5}\right)}{1 + \left(\frac{5}{3}\right)\left(\frac{3}{5}\right)}$
17. $\left(\frac{2}{3}\right)^{-5}$
18. $3^{-1} - 4^{-2}$
19. $\frac{1 + 2^{-3}}{3 - 4^{-1}}$
20. $\frac{3 \cdot 5^{100}}{12 \cdot 5^{98}}$
21. $\sqrt{3^2 + 4^2}$
22. $\sqrt{12} - \sqrt{75}$
23. $(-8)^{2/3} - 9^{-3/2}$
24. $\left(-\frac{32}{9}\right)^{-3/5}$
25. $\sqrt{(3 - 4)^2 + (5 - 2)^2}$
26. $\sqrt{(2 - (-1))^2 + \left(\frac{1}{2} - 3\right)^2}$
27. $\sqrt{(\sqrt{5} - 2\sqrt{5})^2 + (\sqrt{18} - \sqrt{8})^2}$
28. $\frac{-12 + \sqrt{18}}{21}$
29. $\frac{-2 - \sqrt{(2)^2 - 4(3)(-1)}}{2(3)}$
30. $\frac{-(-4) + \sqrt{(-4)^2 - 4(1)(-1)}}{2(1)}$
31. $2(-5)(-5 + 1)^{-1} + (-5)^2(-1)(-5 + 1)^{-2}$
32. $3\sqrt{2(4) + 1} + 3(4)\left(\frac{1}{2}\right)(2(4) + 1)^{-1/2}(2)$
33. $2(-7)\sqrt[3]{1 - (-7)} + (-7)^2\left(\frac{1}{3}\right)(1 - (-7))^{-2/3}(-1)$
34. With the help of your calculator, find $(3.14 \times 10^{87})^{117}$. Write your final answer, using scientific notation, rounded to two decimal places. (See Example 0.2.3.)

0.2.2 ANSWERS

- | | | | |
|-------------------------------|---------------------------|-----------------------|--|
| 1. 6 | 2. 0 | 3. $\frac{2}{21}$ | 4. $\frac{19}{24}$ |
| 5. $-\frac{1}{3}$ | 6. -1 | 7. $\frac{3}{5}$ | 8. 18 |
| 9. $-\frac{7}{8}$ | 10. Undefined. | 11. 0 | 12. Undefined. |
| 13. $\frac{23}{9}$ | 14. $-\frac{4}{99}$ | 15. $-\frac{24}{7}$ | 16. 0 |
| 17. $\frac{243}{32}$ | 18. $\frac{13}{48}$ | 19. $\frac{9}{22}$ | 20. $\frac{25}{4}$ |
| 21. 5 | 22. $-3\sqrt{3}$ | 23. $\frac{107}{27}$ | 24. $-\frac{3\sqrt[5]{3}}{8} = -\frac{3^{6/5}}{8}$ |
| 25. $\sqrt{10}$ | 26. $\frac{\sqrt{61}}{2}$ | 27. $\sqrt{7}$ | |
| 28. $\frac{-4 + \sqrt{2}}{7}$ | 29. -1 | 30. $2 + \sqrt{5}$ | |
| 31. $\frac{15}{16}$ | 32. 13 | 33. $-\frac{385}{12}$ | 34. 1.38×10^{10237} |

0.3 LINEAR EQUATIONS AND INEQUALITIES

In the introduction to this chapter we said that we were going to review “the concepts, skills and vocabulary we believe are prerequisite to a rigorous, college-level Precalculus course.” So far, we’ve presented a lot of vocabulary and concepts but we haven’t done much to refresh the skills needed to survive in the Precalculus wilderness. Thus over the course of the next few sections we will focus our review on the Algebra skills needed to solve basic equations and inequalities. In general, equations and inequalities fall into one of three categories: conditional, identity or contradiction, depending on the nature of their solutions. A **conditional** equation or inequality is true for only *certain* real numbers. For example, $2x + 1 = 7$ is true precisely when $x = 3$, and $w - 3 \leq 4$ is true precisely when $w \leq 7$. An **identity** is an equation or inequality that is true for *all* real numbers. For example, $2x - 3 = 1 + x - 4 + x$ or $2t \leq 2t + 3$. A **contradiction** is an equation or inequality that is *never* true. Examples here include $3x - 4 = 3x + 7$ and $a - 1 > a + 3$.

As you may recall, solving an equation or inequality means finding all of the values of the variable, if any exist, which make the given equation or inequality true. This often requires us to manipulate the given equation or inequality from its given form to an easier form. For example, if we’re asked to solve $3 - 2(x - 3) = 7x + 3(x + 1)$, we get $x = \frac{1}{2}$, but not without a fair amount of algebraic manipulation. In order to obtain the correct answer(s), however, we need to make sure that whatever maneuvers we apply are reversible in order to guarantee that we maintain a chain of **equivalent** equations or inequalities. Two equations or inequalities are called **equivalent** if they have the same solutions. We list these ‘legal moves’ below.

Procedures which Generate Equivalent Equations

- Add (or subtract) the same real number to (from) both sides of the equation.
- Multiply (or divide) both sides of the equation by the same **nonzero** real number.^a

Procedures which Generate Equivalent Inequalities

- Add (or subtract) the same real number to (from) both sides of the equation.
- Multiply (or divide) both sides of the equation by the same **positive** real number.^b

^aMultiplying both sides of an equation by 0 collapses the equation to $0 = 0$, which doesn’t do anybody any good.

^bRemember that if you multiply both sides of an inequality by a negative real number, the inequality sign is reversed: $3 \leq 4$, but $(-2)(3) \geq (-2)(4)$.

0.3.1 LINEAR EQUATIONS

The first type of equations we need to review are **linear** equations as defined below.

Definition 0.10. An equation is said to be **linear** in a variable X if it can be written in the form $AX = B$ where A and B are expressions which do not involve X and $A \neq 0$.

One key point about Definition 0.10 is that the exponent on the unknown ‘ X ’ in the equation is 1, that is $X = X^1$. Our main strategy for solving linear equations is summarized below.

Strategy for Solving Linear Equations

In order to solve an equation which is linear in a given variable, say X :

1. Isolate all of the terms containing X on one side of the equation, putting all of the terms not containing X on the other side of the equation.
2. Factor out the X and divide both sides of the equation by its coefficient.

We illustrate this process with a collection of examples below.

Example 0.3.1. Solve the following equations for the indicated variable. Check your answer.

1. Solve for x : $3x - 6 = 7x + 4$
2. Solve for t : $3 - 1.7t = \frac{t}{4}$
3. Solve for a : $\frac{1}{18}(7 - 4a) + 2 = \frac{a}{3} - \frac{4 - a}{12}$
4. Solve for y : $8y\sqrt{3} + 1 = 7 - \sqrt{12}(5 - y)$
5. Solve for x : $\frac{3x - 1}{2} = x\sqrt{50} + 4$
6. Solve for y : $x(4 - y) = 8y$

Solution.

1. The variable we are asked to solve for is x so our first move is to gather all of the terms involving x on one side and put the remaining terms on the other.¹

$$\begin{array}{rcl}
 3x - 6 & = & 7x + 4 \\
 (3x - 6) - 7x + 6 & = & (7x + 4) - 7x + 6 & \text{Subtract } 7x, \text{ add } 6 \\
 3x - 7x - 6 + 6 & = & 7x - 7x + 4 + 6 & \text{Rearrange terms} \\
 -4x & = & 10 & 3x - 7x = (3 - 7)x = -4x \\
 \frac{-4x}{-4} & = & \frac{10}{-4} & \text{Divide by the coefficient of } x \\
 x & = & -\frac{5}{2} & \text{Reduce to lowest terms}
 \end{array}$$

To check our answer, we substitute $x = -\frac{5}{2}$ into each side of the **original** equation to see the equation is satisfied. Sure enough, $3(-\frac{5}{2}) - 6 = -\frac{27}{2}$ and $7(-\frac{5}{2}) + 4 = -\frac{27}{2}$.

2. In our next example, the unknown is t and we not only have a fraction but also a decimal to wrangle. Fortunately, with equations we can multiply both sides to rid us of these

¹In the margin notes, when we speak of operations, e.g., ‘Subtract $7x$,’ we mean to subtract $7x$ from **both** sides of the equation. The ‘from both sides of the equation’ is omitted in the interest of spacing.

computational obstacles:

$$\begin{aligned}
 3 - 1.7t &= \frac{t}{4} \\
 40(3 - 1.7t) &= 40\left(\frac{t}{4}\right) && \text{Multiply by 40} \\
 40(3) - 40(1.7t) &= \frac{40t}{4} && \text{Distribute} \\
 120 - 68t &= 10t \\
 (120 - 68t) + 68t &= 10t + 68t && \text{Add } 68t \text{ to both sides} \\
 120 &= 78t && 68t + 10t = (68 + 10)t = 78t \\
 \frac{120}{78} &= \frac{78t}{78} && \text{Divide by the coefficient of } t \\
 \frac{120}{78} &= t \\
 \frac{20}{13} &= t && \text{Reduce to lowest terms}
 \end{aligned}$$

To check, we again substitute $t = \frac{20}{13}$ into each side of the original equation. We find that $3 - 1.7\left(\frac{20}{13}\right) = 3 - \left(\frac{17}{10}\right)\left(\frac{20}{13}\right) = \frac{5}{13}$ and $\frac{(20/13)}{4} = \frac{20}{13} \cdot \frac{1}{4} = \frac{5}{13}$ as well.

3. To solve this next equation, we begin once again by clearing fractions. The least common denominator here is 36:

$$\begin{aligned}
 \frac{1}{18}(7 - 4a) + 2 &= \frac{a}{3} - \frac{4 - a}{12} \\
 36\left(\frac{1}{18}(7 - 4a) + 2\right) &= 36\left(\frac{a}{3} - \frac{4 - a}{12}\right) && \text{Multiply by 36} \\
 \frac{36}{18}(7 - 4a) + (36)(2) &= \frac{36a}{3} - \frac{36(4 - a)}{12} && \text{Distribute} \\
 2(7 - 4a) + 72 &= 12a - 3(4 - a) && \text{Distribute} \\
 14 - 8a + 72 &= 12a - 12 + 3a \\
 86 - 8a &= 15a - 12 && 12a + 3a = (12 + 3)a = 15a \\
 (86 - 8a) + 8a + 12 &= (15a - 12) + 8a + 12 && \text{Add } 8a \text{ and } 12 \\
 86 + 12 - 8a + 8a &= 15a + 8a - 12 + 12 && \text{Rearrange terms} \\
 98 &= 23a && 15a + 8a = (15 + 8)a = 23a \\
 \frac{98}{23} &= \frac{23a}{23} && \text{Divide by the coefficient of } a \\
 \frac{98}{23} &= a
 \end{aligned}$$

The check, as usual, involves substituting $a = \frac{98}{23}$ into both sides of the original equation. The reader is encouraged to work through the (admittedly messy) arithmetic. Both sides work out to $\frac{199}{138}$.

4. The square roots may dishearten you but we treat them just like the real numbers they are. Our strategy is the same: get everything with the variable (in this case y) on one side, put everything else on the other and divide by the coefficient of the variable. We've added a few steps to the narrative that we would ordinarily omit just to help you see that this equation is indeed linear.

$$\begin{aligned}
 8y\sqrt{3} + 1 &= 7 - \sqrt{12}(5 - y) \\
 8y\sqrt{3} + 1 &= 7 - \sqrt{12}(5) + \sqrt{12}y && \text{Distribute} \\
 8y\sqrt{3} + 1 &= 7 - (2\sqrt{3})5 + (2\sqrt{3})y && \sqrt{12} = \sqrt{4 \cdot 3} = 2\sqrt{3} \\
 8y\sqrt{3} + 1 &= 7 - 10\sqrt{3} + 2y\sqrt{3} \\
 (8y\sqrt{3} + 1) - 1 - 2y\sqrt{3} &= (7 - 10\sqrt{3} + 2y\sqrt{3}) - 1 - 2y\sqrt{3} && \text{Subtract 1 and } 2y\sqrt{3} \\
 8y\sqrt{3} - 2y\sqrt{3} + 1 - 1 &= 7 - 1 - 10\sqrt{3} + 2y\sqrt{3} - 2y\sqrt{3} && \text{Rearrange terms} \\
 (8\sqrt{3} - 2\sqrt{3})y &= 6 - 10\sqrt{3} \\
 6y\sqrt{3} &= 6 - 10\sqrt{3} && \text{See note below} \\
 \frac{6y\sqrt{3}}{6\sqrt{3}} &= \frac{6 - 10\sqrt{3}}{6\sqrt{3}} && \text{Divide } 6\sqrt{3} \\
 y &= \frac{2 \cdot \sqrt{3} \cdot \sqrt{3} - 2 \cdot 5 \cdot \sqrt{3}}{2 \cdot 3 \cdot \sqrt{3}} \\
 y &= \frac{\cancel{2}\sqrt{3}(\sqrt{3} - 5)}{\cancel{2} \cdot 3 \cdot \cancel{\sqrt{3}}} && \text{Factor and cancel} \\
 y &= \frac{\sqrt{3} - 5}{3}
 \end{aligned}$$

In the list of computations above we marked the row $6y\sqrt{3} = 6 - 10\sqrt{3}$ with a note. That's because we wanted to draw your attention to this line without breaking the flow of the manipulations. The equation $6y\sqrt{3} = 6 - 10\sqrt{3}$ is in fact linear according to Definition 0.10: the variable is y , the value of A is $6\sqrt{3}$ and $B = 6 - 10\sqrt{3}$. Checking the solution, while not trivial, is good mental exercise. Each side works out to be $\frac{27-40\sqrt{3}}{3}$.

5. Proceeding as before, we simplify radicals and clear denominators. Once we gather all of the terms containing x on one side and move the other terms to the other, we factor out x to

identify its coefficient then divide to get our answer.

$$\begin{aligned} \frac{3x-1}{2} &= x\sqrt{50} + 4 \\ \frac{3x-1}{2} &= 5x\sqrt{2} + 4 && \sqrt{50} = \sqrt{25 \cdot 2} \\ 2\left(\frac{3x-1}{2}\right) &= 2(5x\sqrt{2} + 4) && \text{Multiply by 2} \\ \cancel{2} \cdot (3x-1) &= 2(5x\sqrt{2}) + 2 \cdot 4 && \text{Distribute} \\ 3x-1 &= 10x\sqrt{2} + 8 \\ (3x-1) - 10x\sqrt{2} + 1 &= (10x\sqrt{2} + 8) - 10x\sqrt{2} + 1 && \text{Subtract } 10x\sqrt{2}, \text{ add 1} \\ 3x - 10x\sqrt{2} - 1 + 1 &= 10x\sqrt{2} - 10x\sqrt{2} + 8 + 1 && \text{Rearrange terms} \\ 3x - 10x\sqrt{2} &= 9 \\ (3 - 10\sqrt{2})x &= 9 && \text{Factor} \\ \frac{(3 - 10\sqrt{2})x}{3 - 10\sqrt{2}} &= \frac{9}{3 - 10\sqrt{2}} && \text{Divide by the coefficient of } x \\ x &= \frac{9}{3 - 10\sqrt{2}} \end{aligned}$$

The reader is encouraged to check this solution - it isn't as bad as it looks if you're careful!

Each side works out to be $\frac{12 + 5\sqrt{2}}{3 - 10\sqrt{2}}$.

6. If we were instructed to solve our last equation for x , we'd be done in one step: divide both sides by $(4 - y)$ - assuming $4 - y \neq 0$, that is. Alas, we are instructed to solve for y , which means we have some more work to do.

$$\begin{aligned} x(4 - y) &= 8y \\ 4x - xy &= 8y && \text{Distribute} \\ (4x - xy) + xy &= 8y + xy && \text{Add } xy \\ 4x &= (8 + x)y && \text{Factor} \end{aligned}$$

In order to finish the problem, we need to divide both sides of the equation by the coefficient of y which in this case is $8 + x$. Since this expression contains a variable, we need to stipulate that we may perform this division only if $8 + x \neq 0$, or, in other words, $x \neq -8$. Hence, we write our solution as:

$$y = \frac{4x}{8 + x}, \quad \text{provided } x \neq -8$$

What happens if $x = -8$? Substituting $x = -8$ into the original equation gives $(-8)(4 - y) = 8y$ or $-32 + 8y = 8y$. This reduces to $-32 = 0$, which is a contradiction. This means there is no solution when $x = -8$, so we've covered all the bases. Checking our answer requires some Algebra we haven't reviewed yet in this text, but the necessary skills *should* be lurking

somewhere in the mathematical mists of your mind. The adventurous reader is invited to show that both sides work out to $\frac{32x}{x+8}$. \square

0.3.2 LINEAR INEQUALITIES

We now turn our attention to linear inequalities. Unlike linear equations which admit at most one solution, the solutions to linear inequalities are generally intervals of real numbers. While the solution strategy for solving linear inequalities is the same as with solving linear equations, we need to remind ourselves that, should we decide to multiply or divide both sides of an inequality by a **negative** number, we need to reverse the direction of the inequality. (See page 39.) In the example below, we work not only some ‘simple’ linear inequalities in the sense there is only one inequality present, but also some ‘compound’ linear inequalities which require us to use the notions of intersection and union.

Example 0.3.2. Solve the following inequalities for the indicated variable.

1. Solve for x : $\frac{7-8x}{2} \geq 4x+1$
2. Solve for y : $\frac{3}{4} \leq \frac{7-y}{2} < 6$
3. Solve for t : $2t-1 \leq 4-t < 6t+1$
4. Solve for x : $5 + \sqrt{7}x \leq 4x+1 \leq 8$
5. Solve for w : $2.1 - 0.01w \leq -3$ or $2.1 - 0.01w \geq 3$

Solution.

1. We begin by clearing denominators and gathering all of the terms containing x to one side of the inequality and putting the remaining terms on the other.

$$\begin{aligned} \frac{7-8x}{2} &\geq 4x+1 \\ 2\left(\frac{7-8x}{2}\right) &\geq 2(4x+1) && \text{Multiply by 2} \\ \frac{\cancel{2}(7-8x)}{\cancel{2}} &\geq 2(4x)+2(1) && \text{Distribute} \\ 7-8x &\geq 8x+2 \\ (7-8x)+8x-2 &\geq 8x+2+8x-2 && \text{Add } 8x, \text{ subtract } 2 \\ 7-2-8x+8x &\geq 8x+8x+2-2 && \text{Rearrange terms} \\ 5 &\geq 16x && 8x+8x = (8+8)x = 16x \\ \frac{5}{16} &\geq \frac{16x}{16} && \text{Divide by the coefficient of } x \\ \frac{5}{16} &\geq x \end{aligned}$$

We get $\frac{5}{16} \geq x$ or, said differently, $x \leq \frac{5}{16}$. We express this set² of real numbers as $(-\infty, \frac{5}{16}]$. Though not required to do so, we could partially check our answer by substituting $x = \frac{5}{16}$ and

²Using set-builder notation, our ‘set’ of solutions here is $\{x \mid x \leq \frac{5}{16}\}$.

a few other values in our solution set ($x = 0$, for instance) to make sure the inequality holds. (It also isn't a bad idea to choose an $x > \frac{5}{16}$, say $x = 1$, to see that the inequality *doesn't* hold there.) The only real way to actually show that our answer works for *all* values in our solution set is to start with $x \leq \frac{5}{16}$ and reverse all of the steps in our solution procedure to prove it is equivalent to our original inequality.

2. We have our first example of a 'compound' inequality. The solutions to

$$\frac{3}{4} \leq \frac{7-y}{2} < 6$$

must satisfy

$$\frac{3}{4} \leq \frac{7-y}{2} \quad \text{and} \quad \frac{7-y}{2} < 6$$

One approach is to solve each of these inequalities separately, then intersect their solution sets. While this method works (and will be used later for more complicated problems), since our variable y appears only in the middle expression, we can proceed by essentially working both inequalities at once:

$$\begin{array}{rcll} \frac{3}{4} \leq & \frac{7-y}{2} & < 6 & \\ 4\left(\frac{3}{4}\right) \leq & 4\left(\frac{7-y}{2}\right) & < 4(6) & \text{Multiply by 4} \\ \frac{\cancel{4} \cdot 3}{\cancel{4}} \leq & \frac{\cancel{4}(7-y)}{\cancel{2}} & < 24 & \\ 3 \leq & 2(7-y) & < 24 & \\ 3 \leq & 2(7) - 2y & < 24 & \text{Distribute} \\ 3 \leq & 14 - 2y & < 24 & \\ 3 - 14 \leq & (14 - 2y) - 14 & < 24 - 14 & \text{Subtract 14} \\ -11 \leq & -2y & < 10 & \\ \frac{-11}{-2} \geq & \frac{-2y}{-2} & > \frac{10}{-2} & \text{Divide by the coefficient of } y \\ & & & \text{Reverse inequalities} \\ \frac{11}{2} \geq & y & > -5 & \end{array}$$

Our final answer is $\frac{11}{2} \geq y > -5$, or, said differently, $-5 < y \leq \frac{11}{2}$. In interval notation, this is $(-5, \frac{11}{2}]$. We could check the reasonableness of our answer as before, and the reader is encouraged to do so.

3. We have another compound inequality and what distinguishes this one from our previous example is that ' t ' appears on both sides of both inequalities. In this case, we need to create two separate inequalities and find all of the real numbers t which satisfy both $2t - 1 \leq 4 - t$

and $4 - t < 6t + 1$. The first inequality, $2t - 1 \leq 4 - t$, reduces to $3t \leq 5$ or $t \leq \frac{5}{3}$. The second inequality, $4 - t < 6t + 1$, becomes $3 < 7t$ which reduces to $t > \frac{3}{7}$. Thus our solution is all real numbers t with $t \leq \frac{5}{3}$ and $t > \frac{3}{7}$, or, writing this as a compound inequality, $\frac{3}{7} < t \leq \frac{5}{3}$. Using interval notation,³ we express our solution as $(\frac{3}{7}, \frac{5}{3}]$.

4. As before, with this inequality we have no choice but to solve each inequality individually and intersect the solution sets. Starting with the leftmost inequality, we first note that the in the term $\sqrt{7}x$, the vinculum of the square root extends over the 7 only, meaning the x is not part of the radicand. In order to avoid confusion, we will write $\sqrt{7}x$ as $x\sqrt{7}$.

$$\begin{aligned} 5 + x\sqrt{7} &\leq 4x + 1 \\ (5 + x\sqrt{7}) - 4x - 5 &\leq (4x + 1) - 4x - 5 && \text{Subtract } 4x \text{ and } 5 \\ x\sqrt{7} - 4x + 5 - 5 &\leq 4x - 4x + 1 - 5 && \text{Rearrange terms} \\ x(\sqrt{7} - 4) &\leq -4 && \text{Factor} \end{aligned}$$

At this point, we need to exercise a bit of caution because the number $\sqrt{7} - 4$ is negative.⁴ When we divide by it the inequality reverses:

$$\begin{aligned} x(\sqrt{7} - 4) &\leq -4 \\ \frac{x(\sqrt{7} - 4)}{\sqrt{7} - 4} &\geq \frac{-4}{\sqrt{7} - 4} && \begin{array}{l} \text{Divide by the coefficient of } x \\ \text{Reverse inequalities} \end{array} \\ x &\geq \frac{-4}{\sqrt{7} - 4} \\ x &\geq \frac{-4}{-(4 - \sqrt{7})} \\ x &\geq \frac{4}{4 - \sqrt{7}} \end{aligned}$$

We're only half done because we still have the rightmost inequality to solve. Fortunately, that one seems rather mundane: $4x + 1 \leq 8$ reduces to $x \leq \frac{7}{4}$ without too much incident. Our solution is $x \geq \frac{4}{4 - \sqrt{7}}$ and $x \leq \frac{7}{4}$. We may be tempted to write $\frac{4}{4 - \sqrt{7}} \leq x \leq \frac{7}{4}$ and call it a day but that would be nonsense! To see why, notice that $\sqrt{7}$ is between 2 and 3 so $\frac{4}{4 - \sqrt{7}}$ is between $\frac{4}{4 - 2} = 2$ and $\frac{4}{4 - 3} = 4$. In particular, we get $\frac{4}{4 - \sqrt{7}} > 2$. On the other hand, $\frac{7}{4} < 2$. This means that our 'solutions' have to be simultaneously greater than 2 AND less than 2 which is impossible. Therefore, this compound inequality has no solution, which means we did all that work for nothing.⁵

5. Our last example is yet another compound inequality but here, instead of the two inequalities being connected with the conjunction 'and', they are connected with 'or', which indicates

³If we intersect the solution sets of the two individual inequalities, we get the answer, too: $(-\infty, \frac{5}{3}] \cap (\frac{3}{7}, \infty) = (\frac{3}{7}, \frac{5}{3}]$.

⁴Since $4 < 7 < 9$, it stands to reason that $\sqrt{4} < \sqrt{7} < \sqrt{9}$ so $2 < \sqrt{7} < 3$.

⁵Much like how people walking on treadmills get nowhere. Math is the endurance cardio of the brain, folks!

that we need to find the *union* of the results of each. Starting with $2.1 - 0.01w \leq -3$, we get $-0.01w \leq -5.1$, which gives⁶ $w \geq 510$. The second inequality, $2.1 - 0.01w \geq 3$, becomes $-0.01w \geq 0.9$, which reduces to $w \leq -90$. Our solution set consists of all real numbers w with $w \geq 510$ or $w \leq -90$. In interval notation, this is $(-\infty, -90] \cup [510, \infty)$. \square

⁶Don't forget to flip the inequality!

0.3.3 EXERCISES

In Exercises 1 - 9, solve the given linear equation and check your answer.

1. $3x - 4 = 2 - 4(x - 3)$
2. $\frac{3 - 2t}{4} = 7t + 1$
3. $\frac{2(w - 3)}{5} = \frac{4}{15} - \frac{3w + 1}{9}$
4. $-0.02y + 1000 = 0$
5. $\frac{49w - 14}{7} = 3w - (2 - 4w)$
6. $7 - (4 - x) = \frac{2x - 3}{2}$
7. $3t\sqrt{7} + 5 = 0$
8. $\sqrt{50}y = \frac{6 - \sqrt{8}y}{3}$
9. $4 - (2x + 1) = \frac{x\sqrt{7}}{9}$

In equations 10 - 27, solve each equation for the indicated variable.

10. Solve for y : $3x + 2y = 4$
11. Solve for x : $3x + 2y = 4$
12. Solve for C : $F = \frac{9}{5}C + 32$
13. Solve for x : $p = -2.5x + 15$
14. Solve for x : $C = 200x + 1000$
15. Solve for y : $x = 4(y + 1) + 3$
16. Solve for w : $vw - 1 = 3v$
17. Solve for v : $vw - 1 = 3v$
18. Solve for y : $x(y - 3) = 2y + 1$
19. Solve for π : $C = 2\pi r$
20. Solve for V : $PV = nRT$
21. Solve for R : $PV = nRT$
22. Solve for g : $E = mgh$
23. Solve for m : $E = \frac{1}{2}mv^2$

In Exercises 24 - 27, the subscripts on the variables have no intrinsic mathematical meaning; they're just used to distinguish one variable from another. In other words, treat ' P_1 ' and ' P_2 ' as two different variables as you would ' x ' and ' y .' (The same goes for ' x ' and ' x_0 ,' etc.)

24. Solve for V_2 : $P_1V_1 = P_2V_2$
25. Solve for t : $x = x_0 + at$
26. Solve for x : $y - y_0 = m(x - x_0)$
27. Solve for T_1 : $q = mc(T_2 - T_1)$
28. With the help of your classmates, find values for c so that the equation: $2x - 5c = 1 - c(x + 2)$
 - (a) has $x = 42$ as a solution.
 - (b) has no solution (that is, the equation is a contradiction.)

Is it possible to find a value of c so the equation is an identity? Explain.

In Exercises 29 - 46, solve the given inequality. Write your answer using interval notation.

29. $3 - 4x \geq 0$

30. $2t - 1 < 3 - (4t - 3)$

31. $\frac{7-y}{4} \geq 3y + 1$

32. $0.05R + 1.2 > 0.8 - 0.25R$

33. $7 - (2 - x) \leq x + 3$

34. $\frac{10m+1}{5} \geq 2m - \frac{1}{2}$

35. $x\sqrt{12} - \sqrt{3} > \sqrt{3}x + \sqrt{27}$

36. $2t - 7 \leq \sqrt[3]{18}t$

37. $117y \geq y\sqrt{2} - 7y\sqrt[4]{8}$

38. $-\frac{1}{2} \leq 5x - 3 \leq \frac{1}{2}$

39. $-\frac{3}{2} \leq \frac{4-2t}{10} < \frac{7}{6}$

40. $-0.1 \leq \frac{5-x}{3} - 2 < 0.1$

41. $2y \leq 3 - y < 7$

42. $3x \geq 4 - x \geq 3$

43. $6 - 5t > \frac{4t}{3} \geq t - 2$

44. $2x + 1 \leq -1$ or $2x + 1 \geq 1$

45. $4 - x \leq 0$ or $2x + 7 < x$

46. $\frac{5-2x}{3} > x$ or $2x + 5 \geq 1$

0.3.4 ANSWERS

1. $x = \frac{18}{7}$
2. $t = -\frac{1}{30}$
3. $w = \frac{61}{33}$
4. $y = 50000$
5. All real numbers.
6. No solution.
7. $t = -\frac{5}{3\sqrt{7}} = -\frac{5\sqrt{7}}{21}$
8. $y = \frac{6}{17\sqrt{2}} = \frac{3\sqrt{2}}{17}$
9. $x = \frac{27}{18 + \sqrt{7}}$
10. $y = \frac{4-3x}{2}$ or $y = -\frac{3}{2}x + 2$
11. $x = \frac{4-2y}{3}$ or $x = -\frac{2}{3}y + \frac{4}{3}$
12. $C = \frac{5}{9}(F-32)$ or $C = \frac{5}{9}F - \frac{160}{9}$
13. $x = \frac{p-15}{-2.5} = \frac{15-p}{2.5}$ or $x = -\frac{2}{5}p + 6$.
14. $x = \frac{C-1000}{200}$ or $x = \frac{1}{200}C - 5$
15. $y = \frac{x-7}{4}$ or $y = \frac{1}{4}x - \frac{7}{4}$
16. $w = \frac{3v+1}{v}$, provided $v \neq 0$.
17. $v = \frac{1}{w-3}$, provided $w \neq 3$.
18. $y = \frac{3x+1}{x-2}$, provided $x \neq 2$.
19. $\pi = \frac{C}{2r}$, provided $r \neq 0$.
20. $V = \frac{nRT}{P}$, provided $P \neq 0$.
21. $R = \frac{PV}{nT}$, provided $n \neq 0, T \neq 0$.
22. $g = \frac{E}{mh}$, provided $m \neq 0, h \neq 0$.
23. $m = \frac{2E}{v^2}$, provided $v^2 \neq 0$ (so $v \neq 0$).
24. $V_2 = \frac{P_1V_1}{P_2}$, provided $P_2 \neq 0$.
25. $t = \frac{x-x_0}{a}$, provided $a \neq 0$.
26. $x = \frac{y-y_0+mx_0}{m}$ or $x = x_0 + \frac{y-y_0}{m}$, provided $m \neq 0$.
27. $T_1 = \frac{mcT_2 - q}{mc}$ or $T_1 = T_2 - \frac{q}{mc}$, provided $m \neq 0, c \neq 0$.
29. $\left(-\infty, \frac{3}{4}\right]$
30. $\left(-\infty, \frac{7}{6}\right)$
31. $\left(-\infty, \frac{3}{13}\right]$
32. $\left(-\frac{4}{3}, \infty\right)$
33. No solution.
34. $(-\infty, \infty)$
35. $(4, \infty)$
36. $\left[\frac{7}{2-\sqrt[3]{18}}, \infty\right)$
37. $[0, \infty)$
38. $\left[\frac{1}{2}, \frac{7}{10}\right]$
39. $\left(-\frac{23}{6}, \frac{19}{2}\right]$
40. $\left(-\frac{13}{10}, -\frac{7}{10}\right]$

41. $(-4, 1]$

42. $\{1\} = [1, 1]$

43. $\left[-6, \frac{18}{19}\right)$

44. $(-\infty, -1] \cup [0, \infty)$

45. $(-\infty, -7) \cup [4, \infty)$

46. $(-\infty, \infty)$

0.4 ABSOLUTE VALUE EQUATIONS AND INEQUALITIES

In this section, we review some basic concepts involving the absolute value of a real number x . There are a few different ways to define absolute value and in this section we choose the following definition. (Absolute value will be revisited in much greater depth in Section 2.2 where we present what one can think of as the “precise” definition.)

Definition 0.11. Absolute Value as Distance: For every real number x , the **absolute value** of x , denoted $|x|$, is the distance between x and 0 on the number line. More generally, if x and c are real numbers, $|x - c|$ is the distance between the numbers x and c on the number line.

For example, $|5| = 5$ and $|-5| = 5$, since each is 5 units from 0 on the number line:

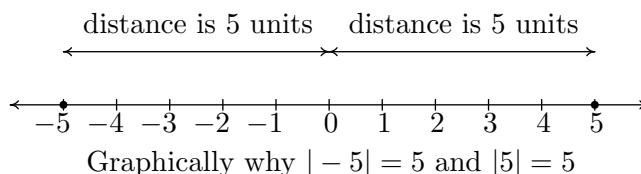

Computationally, the absolute value ‘makes negative numbers positive’, though we need to be a little cautious with this description. While $|-7| = 7$, $|5 - 7| \neq 5 + 7$. The absolute value acts as a grouping symbol, so $|5 - 7| = |-2| = 2$, which makes sense since 5 and 7 are two units away from each other on the number line:

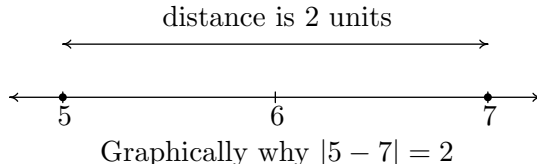

We list some of the operational properties of absolute value below.

Theorem 0.2. Properties of Absolute Value: Let a , b and x be real numbers and let n be an integer.^a Then

- **Product Rule:** $|ab| = |a||b|$
- **Power Rule:** $|a^n| = |a|^n$ whenever a^n is defined
- **Quotient Rule:** $\left|\frac{a}{b}\right| = \frac{|a|}{|b|}$, provided $b \neq 0$

^aSee page 136 if you don’t remember what an integer is.

The proof of Theorem 0.2 is difficult, but not impossible, using the distance definition of absolute value or even the ‘it makes negatives positive’ notion. It is, however, much easier if one uses the “precise” definition given in Section 2.2 so we will revisit the proof then. For now, let’s focus on how to solve basic equations and inequalities involving the absolute value.

0.4.1 ABSOLUTE VALUE EQUATIONS

Thinking of absolute value in terms of distance gives us a geometric way to interpret equations. For example, to solve $|x| = 3$, we are looking for all real numbers x whose distance from 0 is 3 units. If we move three units to the right of 0, we end up at $x = 3$. If we move three units to the left, we end up at $x = -3$. Thus the solutions to $|x| = 3$ are $x = \pm 3$.

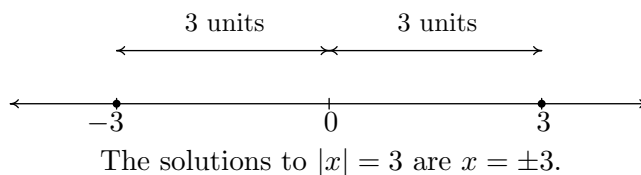

Thinking this way gives us the following.

Theorem 0.3. Absolute Value Equations: Suppose x , y and c are real numbers.

- $|x| = 0$ if and only if $x = 0$.
- For $c > 0$, $|x| = c$ if and only if $x = c$ or $x = -c$.
- For $c < 0$, $|x| = c$ has no solution.
- $|x| = |y|$ if and only if $x = y$ or $x = -y$.

(That is, if two numbers have the same absolute values, they are either the same number or exact opposites.)

Theorem 0.3 is our main tool in solving equations involving the absolute value, since it allows us a way to rewrite such equations as compound linear equations.

Strategy for Solving Equations Involving Absolute Value

In order to solve an equation involving the absolute value of a quantity $|X|$:

1. Isolate the absolute value on one side of the equation so it has the form $|X| = c$.
2. Apply Theorem 0.3.

The techniques we use to ‘isolate the absolute value’ are precisely those we used in Section 0.3 to isolate the variable when solving linear equations. Time for some practice.

Example 0.4.1. Solve each of the following equations.

1. $|3x - 1| = 6$

2. $\frac{3 - |y + 5|}{2} = 1$

3. $3|2t + 1| - \sqrt{5} = 0$

$$4. 4 - |5w + 3| = 5 \qquad 5. |3 - x\sqrt[3]{12}| = |4x + 1| \qquad 6. |t - 1| - 3|t + 1| = 0$$

Solution.

1. The equation $|3x - 1| = 6$ is of already in the form $|X| = c$, so we know $3x - 1 = 6$ or $3x - 1 = -6$. Solving the former gives us at $x = \frac{7}{3}$ and solving the latter yields $x = -\frac{5}{3}$. We may check both of these solutions by substituting them into the original equation and showing that the arithmetic works out.
2. We begin solving $\frac{3-|y+5|}{2} = 1$ by isolating the absolute value to put it in the form $|X| = c$.

$$\begin{aligned} \frac{3 - |y + 5|}{2} &= 1 \\ 3 - |y + 5| &= 2 && \text{Multiply by 2} \\ -|y + 5| &= -1 && \text{Subtract 3} \\ |y + 5| &= 1 && \text{Divide by } -1 \end{aligned}$$

At this point, we have $y + 5 = 1$ or $y + 5 = -1$, so our solutions are $y = -4$ or $y = -6$. We leave it to the reader to check both answers in the original equation.

3. As in the previous example, we first isolate the absolute value. Don't let the $\sqrt{5}$ throw you off - it's just another real number, so we treat it as such:

$$\begin{aligned} 3|2t + 1| - \sqrt{5} &= 0 \\ 3|2t + 1| &= \sqrt{5} && \text{Add } \sqrt{5} \\ |2t + 1| &= \frac{\sqrt{5}}{3} && \text{Divide by 3} \end{aligned}$$

From here, we have that $2t + 1 = \frac{\sqrt{5}}{3}$ or $2t + 1 = -\frac{\sqrt{5}}{3}$. The first equation gives $t = \frac{\sqrt{5}-3}{6}$ while the second gives $t = \frac{-\sqrt{5}-3}{6}$ thus we list our answers as $t = \frac{-3 \pm \sqrt{5}}{6}$. The reader should enjoy the challenge of substituting both answers into the original equation and following through the arithmetic to see that both answers work.

4. Upon isolating the absolute value in the equation $4 - |5w + 3| = 5$, we get $|5w + 3| = -1$. At this point, we know there cannot be any real solution. By definition, the absolute value is a *distance*, and as such is never negative. We write 'no solution' and carry on.
5. Our next equation already has the absolute value expressions (plural) isolated, so we work from the principle that if $|x| = |y|$, then $x = y$ or $x = -y$. Thus from $|3 - x\sqrt[3]{12}| = |4x + 1|$ we get two equations to solve:

$$3 - x\sqrt[3]{12} = 4x + 1, \qquad \text{and} \qquad 3 - x\sqrt[3]{12} = -(4x + 1)$$

Notice that the right side of the second equation is $-(4x + 1)$ and not simply $-4x + 1$. Remember, the expression $4x + 1$ represents a single real number so in order to negate it we

need to negate the *entire* expression $-(4x+1)$. Moving along, when solving $3 - x\sqrt[3]{12} = 4x+1$, we obtain $x = \frac{2}{4+\sqrt[3]{12}}$ and the solution to $3 - x\sqrt[3]{12} = -(4x+1)$ is $x = \frac{4}{\sqrt[3]{12}-4}$. As usual, the reader is invited to check these answers by substituting them into the original equation.

6. We start by isolating one of the absolute value expressions: $|t-1| - 3|t+1| = 0$ gives $|t-1| = 3|t+1|$. While this *resembles* the form $|x| = |y|$, the coefficient 3 in $3|t+1|$ prevents it from being an exact match. Not to worry - since 3 is positive, $3 = |3|$ so

$$3|t+1| = |3||t+1| = |3(t+1)| = |3t+3|.$$

Hence, our equation becomes $|t-1| = |3t+3|$ which results in the two equations: $t-1 = 3t+3$ and $t-1 = -(3t+3)$. The first equation gives $t = -2$ and the second gives $t = -\frac{1}{2}$. The reader is encouraged to check both answers in the original equation. \square

0.4.2 ABSOLUTE VALUE INEQUALITIES

We now turn our attention to solving some basic inequalities involving the absolute value. Suppose we wished to solve $|x| < 3$. Geometrically, we are looking for all of the real numbers whose distance from 0 is *less* than 3 units. We get $-3 < x < 3$, or in interval notation, $(-3, 3)$. Suppose we are asked to solve $|x| > 3$ instead. Now we want the distance between x and 0 to be *greater* than 3 units. Moving in the positive direction, this means $x > 3$. In the negative direction, this puts $x < -3$. Our solutions would then satisfy $x < -3$ *or* $x > 3$. In interval notation, we express this as $(-\infty, -3) \cup (3, \infty)$.

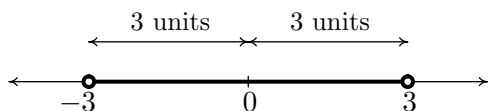

The solution to $|x| < 3$ is $(-3, 3)$

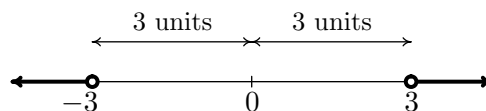

The solution to $|x| > 3$ is $(-\infty, -3) \cup (3, \infty)$

Generalizing this notion, we get the following:

Theorem 0.4. Inequalities Involving Absolute Value: Let c be a real number.

- If $c > 0$, $|x| < c$ is equivalent to $-c < x < c$.
- If $c \leq 0$, $|x| < c$ has no solution.
- If $c > 0$, $|x| > c$ is equivalent to $x < -c$ or $x > c$.
- If $c \leq 0$, $|x| > c$ is true for all real numbers.

If the inequality we're faced with involves ' \leq ' or ' \geq ,' we can combine the results of Theorem 0.4 with Theorem 0.3 as needed.

Strategy for Solving Inequalities Involving Absolute Value

In order to solve an inequality involving the absolute value of a quantity $|X|$:

1. Isolate the absolute value on one side of the inequality.
2. Apply Theorem 0.4.

Example 0.4.2. Solve the following inequalities.

- | | |
|-----------------------------------|---|
| 1. $ x - \sqrt[4]{5} > 1$ | 2. $\frac{4 - 2 2x + 1 }{4} \geq -\sqrt{3}$ |
| 3. $ 2x - 1 \leq 3 4 - 8x - 10$ | 4. $ 2x - 1 \leq 3 4 - 8x + 10$ |
| 5. $2 < x - 1 \leq 5$ | 6. $ 10x - 5 + 10 - 5x \leq 0$ |

Solution.

1. From Theorem 0.4, $|x - \sqrt[4]{5}| > 1$ is equivalent to $x - \sqrt[4]{5} < -1$ or $x - \sqrt[4]{5} > 1$. Solving this compound inequality, we get $x < -1 + \sqrt[4]{5}$ or $x > 1 + \sqrt[4]{5}$. Our answer, in interval notation, is: $(-\infty, -1 + \sqrt[4]{5}) \cup (1 + \sqrt[4]{5}, \infty)$. As with linear inequalities, we can partially check our answer by selecting values of x both inside and outside the solution intervals to see which values of x satisfy the original inequality and which do not.
2. Our first step in solving $\frac{4 - 2|2x + 1|}{4} \geq -\sqrt{3}$ is to isolate the absolute value.

$$\begin{aligned} \frac{4 - 2|2x + 1|}{4} &\geq -\sqrt{3} \\ 4 - 2|2x + 1| &\geq -4\sqrt{3} && \text{Multiply by 4} \\ -2|2x + 1| &\geq -4 - 4\sqrt{3} && \text{Subtract 4} \\ |2x + 1| &\leq \frac{-4 - 4\sqrt{3}}{-2} && \text{Divide by } -2, \text{ reverse the inequality} \\ |2x + 1| &\leq 2 + 2\sqrt{3} && \text{Reduce} \end{aligned}$$

Since we're dealing with ' \leq ' instead of just '<,' we can combine Theorems 0.4 and 0.3 to rewrite this last inequality as:¹ $-(2 + 2\sqrt{3}) \leq 2x + 1 \leq 2 + 2\sqrt{3}$. Subtracting the '1' across both inequalities gives $-3 - 2\sqrt{3} \leq 2x \leq 1 + 2\sqrt{3}$, which reduces to $\frac{-3 - 2\sqrt{3}}{2} \leq x \leq \frac{1 + 2\sqrt{3}}{2}$. In interval notation this reads as $\left[\frac{-3 - 2\sqrt{3}}{2}, \frac{1 + 2\sqrt{3}}{2}\right]$.

3. There are two absolute values in $|2x - 1| \leq 3|4 - 8x| - 10$, so it is unclear how we are to proceed. However, before jumping in and trying to apply (or misapply) Theorem 0.4, we note

¹Note the use of parentheses: $-(2 + 2\sqrt{3})$ as opposed to $-2 + 2\sqrt{3}$.

that $|4 - 8x| = |(-4)(2x - 1)|$. Using this, we get:

$$\begin{array}{rcl}
 |2x - 1| & \leq & 3|4 - 8x| - 10 \\
 |2x - 1| & \leq & 3|(-4)(2x - 1)| - 10 & \text{Factor} \\
 |2x - 1| & \leq & 3|-4||2x - 1| - 10 & \text{Product Rule} \\
 |2x - 1| & \leq & 12|2x - 1| - 10 \\
 -11|2x - 1| & \leq & -10 & \text{Subtract } 12|2x - 1| \\
 |2x - 1| & \geq & \frac{10}{11} & \text{Divide by } -11 \text{ and reduce}
 \end{array}$$

At this point, we invoke Theorems 0.3 and 0.4 and write the equivalent compound inequality: $2x - 1 \leq -\frac{10}{11}$ or $2x - 1 \geq \frac{10}{11}$. We get $x \leq \frac{1}{22}$ or $x \geq \frac{21}{22}$, which, in interval notation reads $(-\infty, \frac{1}{22}] \cup [\frac{21}{22}, \infty)$.

- The inequality $|2x - 1| \leq 3|4 - 8x| + 10$ differs from the previous example in exactly one respect: on the right side of the inequality, we have '+10' instead of '-10.' The steps to isolate the absolute value here are identical to those in the previous example, but instead of obtaining $|2x - 1| \geq \frac{10}{11}$ as before, we obtain $|2x - 1| \geq -\frac{10}{11}$. This latter inequality is *always* true. (Absolute value is, by definition, a distance and hence always 0 or greater.) Thus our solution to this inequality is all real numbers, $(-\infty, \infty)$.
- To solve $2 < |x - 1| \leq 5$, we rewrite it as the compound inequality: $2 < |x - 1|$ and $|x - 1| \leq 5$. The first inequality, $2 < |x - 1|$, can be re-written as $|x - 1| > 2$ so it is equivalent to $x - 1 < -2$ or $x - 1 > 2$. Thus the solution to $2 < |x - 1|$ is $x < -1$ or $x > 3$, which in interval notation is $(-\infty, -1) \cup (3, \infty)$. For $|x - 1| \leq 5$, we combine the results of Theorems 0.3 and 0.4 to get $-5 \leq x - 1 \leq 5$ so that $-4 \leq x \leq 6$, or $[-4, 6]$. Our solution to $2 < |x - 1| \leq 5$ is comprised of values of x which satisfy both parts of the inequality, so we intersect $(-\infty, -1) \cup (3, \infty)$ with $[-4, 6]$ to get our final answer $[-4, -1) \cup (3, 6]$.
- Our first hope when encountering $|10x - 5| + |10 - 5x| \leq 0$ is that we can somehow combine the two absolute value quantities as we'd done in earlier examples. We leave it to the reader to show, however, that no matter what we try to factor out of the absolute value quantities, what remains inside the absolute values will always be different. At this point, we take a step back and look at the equation in a more general way: we are adding two absolute values together and wanting the result to be less than or equal to 0. Since the absolute value of anything is always 0 or greater, there are no solutions to: $|10x - 5| + |10 - 5x| < 0$. Is it possible that $|10x - 5| + |10 - 5x| = 0$? Only if there is an x where $|10x - 5| = 0$ and $|10 - 5x| = 0$ *at the same time*.² The first equation holds only when $x = \frac{1}{2}$, while the second holds only when $x = 2$. Alas, we have no solution.³ \square

We close this section with an example of how the properties in Theorem 0.2 are used in Calculus. Here, ' ε ' is the Greek letter 'epsilon' and it represents a positive real number. Those of you

²Do you see why?

³Not for lack of trying, however!

who will be taking Calculus in the future should become *very* familiar with this type of algebraic manipulation.

$$\begin{aligned} \left| \frac{8-4x}{3} \right| &< \varepsilon \\ \frac{|8-4x|}{|3|} &< \varepsilon && \text{Quotient Rule} \\ \frac{|-4(x-2)|}{3} &< \varepsilon && \text{Factor} \\ \frac{|-4||x-2|}{3} &< \varepsilon && \text{Product Rule} \\ \frac{4|x-2|}{3} &< \varepsilon \\ \frac{3}{4} \cdot \frac{4|x-2|}{3} &< \frac{3}{4} \cdot \varepsilon && \text{Multiply by } \frac{3}{4} \\ |x-2| &< \frac{3}{4}\varepsilon \end{aligned}$$

0.4.3 EXERCISES

In Exercises 1 - 18, solve the equation.

1. $|x| = 6$

2. $|3t - 1| = 10$

3. $|4 - w| = 7$

4. $4 - |y| = 3$

5. $2|5m + 1| - 3 = 0$

6. $|7x - 1| + 2 = 0$

7. $\frac{5 - |x|}{2} = 1$

8. $\frac{2}{3}|5 - 2w| - \frac{1}{2} = 5$

9. $|3t - \sqrt{2}| + 4 = 6$

10. $\frac{|2v + 1| - 3}{4} = \frac{1}{2} - |2v + 1|$

11. $|2x + 1| = \frac{|2x + 1| - 3}{2}$

12. $\frac{|3 - 2y| + 4}{2} = 2 - |3 - 2y|$

13. $|3t - 2| = |2t + 7|$

14. $|3x + 1| = |4x|$

15. $|1 - \sqrt{2}y| = |y + 1|$

16. $|4 - x| - |x + 2| = 0$

17. $|2 - 5z| = 5|z + 1|$

18. $\sqrt{3}|w - 1| = 2|w + 1|$

In Exercises 19 - 30, solve the inequality. Write your answer using interval notation.

19. $|3x - 5| \leq 4$

20. $|7t + 2| > 10$

21. $|2w + 1| - 5 < 0$

22. $|2 - y| - 4 \geq -3$

23. $|3z + 5| + 2 < 1$

24. $2|7 - v| + 4 > 1$

25. $3 - |x + \sqrt{5}| < -3$

26. $|5t| \leq |t| + 3$

27. $|w - 3| < |3 - w|$

28. $2 \leq |4 - y| < 7$

29. $1 < |2w - 9| \leq 3$

30. $3 > 2|\sqrt{3} - x| > 1$

31. With help from your classmates, solve:

(a) $|5 - |2x - 3|| = 4$

(b) $|5 - |2x - 3|| < 4$

0.4.4 ANSWERS

- | | | |
|--|---|--|
| 1. $x = -6$ or $x = 6$ | 2. $t = -3$ or $t = \frac{11}{3}$ | 3. $w = -3$ or $w = 11$ |
| 4. $y = -1$ or $y = 1$ | 5. $m = -\frac{1}{2}$ or $m = \frac{1}{10}$ | 6. No solution |
| 7. $x = -3$ or $x = 3$ | 8. $w = -\frac{13}{8}$ or $w = \frac{53}{8}$ | 9. $t = \frac{\sqrt{2} \pm 2}{3}$ |
| 10. $v = -1$ or $v = 0$ | 11. No solution | 12. $y = \frac{3}{2}$ |
| 13. $t = -1$ or $t = 9$ | 14. $x = -\frac{1}{7}$ or $x = 1$ | 15. $y = 0$ or $y = \frac{2}{\sqrt{2} - 1}$ |
| 16. $x = 1$ | 17. $z = -\frac{3}{10}$ | 18. $w = \frac{\sqrt{3} \pm 2}{\sqrt{3} \mp 2}$
See footnote ⁴ |
| 19. $\left[\frac{1}{3}, 3\right]$ | 20. $\left(-\infty, -\frac{12}{7}\right) \cup \left(\frac{8}{7}, \infty\right)$ | 21. $(-3, 2)$ |
| 22. $(-\infty, 1] \cup [3, \infty)$ | 23. No solution | 24. $(-\infty, \infty)$ |
| 25. $(-\infty, -6 - \sqrt{5}) \cup (6 - \sqrt{5}, \infty)$ | 26. $\left[-\frac{3}{4}, \frac{3}{4}\right]$ | |
| 27. No solution | 28. $(-3, 2] \cup [6, 11)$ | 29. $[3, 4) \cup (5, 6]$ |
| 30. $\left(\frac{2\sqrt{3} - 3}{2}, \frac{2\sqrt{3} - 1}{2}\right) \cup \left(\frac{2\sqrt{3} + 1}{2}, \frac{2\sqrt{3} + 3}{2}\right)$ | | |
| 31. (a) $x = -3$, or $x = 1$, or $x = 2$, or $x = 6$
(b) $(-3, 1) \cup (2, 6)$ | | |

⁴That is, $w = \frac{\sqrt{3} + 2}{\sqrt{3} - 2}$ or $w = \frac{\sqrt{3} - 2}{\sqrt{3} + 2}$

0.5 POLYNOMIAL ARITHMETIC

In this section, we review the arithmetic of **polynomials**. What precisely is a polynomial?

Definition 0.12. A **polynomial** is a sum of terms each of which is a real number or a real number multiplied by one or more variables to natural number powers.

Some examples of polynomials are $x^2 + x\sqrt{3} + 4$, $27x^2y + \frac{7x}{2}$ and 6. Things like $3\sqrt{x}$, $4x - \frac{2}{x+1}$ and $13x^{2/3}y^2$ are **not** polynomials. (Do you see why not?) Below we review some of the terminology associated with polynomials.

Definition 0.13. Polynomial Vocabulary

- **Constant Terms:** Terms in polynomials without variables are called **constant** terms.
- **Coefficient:** In non-constant terms, the real number factor in the expression is called the **coefficient** of the term.
- **Degree:** The **degree** of a non-constant term is the sum of the exponents on the variables in the term; non-zero constant terms are defined to have degree 0. The degree of a polynomial is the highest degree of the nonzero terms.
- **Like Terms:** Terms in a polynomial are called **like** terms if they have the same variables each with the same corresponding exponents.
- **Simplified:** A polynomial is said to be **simplified** if all arithmetic operations have been completed and there are no longer any like terms.
- **Classification by Number of Terms:** A simplified polynomial is called a
 - **monomial** if it has exactly one nonzero term
 - **binomial** if it has exactly two nonzero terms
 - **trinomial** if it has exactly three nonzero terms

For example, $x^2 + x\sqrt{3} + 4$ is a trinomial of degree 2. The coefficient of x^2 is 1 and the constant term is 4. The polynomial $27x^2y + \frac{7x}{2}$ is a binomial of degree 3 ($x^2y = x^2y^1$) with constant term 0.

The concept of ‘like’ terms really amounts to finding terms which can be combined using the Distributive Property. For example, in the polynomial $17x^2y - 3xy^2 + 7xy^2$, $-3xy^2$ and $7xy^2$ are like terms, since they have the same variables with the same corresponding exponents. This allows us to combine these two terms as follows:

$$17x^2y - 3xy^2 + 7xy^2 = 17x^2y + (-3)xy^2 + 7xy^2 + 17x^2y + (-3 + 7)xy^2 = 17x^2y + 4xy^2$$

Note that even though $17x^2y$ and $4xy^2$ have the same variables, they are not like terms since in the first term we have x^2 and $y = y^1$ but in the second we have $x = x^1$ and $y = y^2$ so the corresponding exponents aren’t the same. Hence, $17x^2y + 4xy^2$ is the simplified form of the polynomial.

There are four basic operations we can perform with polynomials: addition, subtraction, multiplication and division. The first three of these operations follow directly from properties of real number arithmetic and will be discussed together first. Division, on the other hand, is a bit more complicated and will be discussed separately.

0.5.1 POLYNOMIAL ADDITION, SUBTRACTION AND MULTIPLICATION.

Adding and subtracting polynomials comes down to identifying like terms and then adding or subtracting the coefficients of those like terms. Multiplying polynomials comes to us courtesy of the Generalized Distributive Property.

Theorem 0.5. Generalized Distributive Property: To multiply a quantity of n terms by a quantity of m terms, multiply each of the n terms of the first quantity by each of the m terms in the second quantity and add the resulting $n \cdot m$ terms together.

In particular, Theorem 0.5 says that, before combining like terms, a product of an n -term polynomial and an m -term polynomial will generate $(n \cdot m)$ -terms. For example, a binomial times a trinomial will produce six terms some of which may be like terms. Thus the simplified end result may have fewer than six terms but you will start with six terms.

A special case of Theorem 0.5 is the famous **F.O.I.L.**, listed here:¹

Theorem 0.6. F.O.I.L.: The terms generated from the product of two binomials: $(a + b)(c + d)$ can be verbalized as follows “Take the sum of:

- the product of the **F**irst terms a and c , ac
- the product of the **O**uter terms a and d , ad
- the product of the **I**nnner terms b and c , bc
- the product of the **L**ast terms b and d , bd .”

That is, $(a + b)(c + d) = ac + ad + bc + bd$.

Theorem 0.5 is best proved using the technique known as Mathematical Induction, which is a topic for another course. The result is really nothing more than repeated applications of the Distributive Property so it seems reasonable and we’ll use it without proof for now. The other major piece of polynomial multiplication is one of the Power Rules of Exponents from page 27 in Section 0.2, namely $a^n a^m = a^{n+m}$. The Commutative and Associative Properties of addition and multiplication are also used extensively. We put all of these properties to good use in the next example.

¹We caved to peer pressure on this one. Apparently all of the cool Precalculus books have FOIL in them even though it’s redundant once you know how to distribute multiplication across addition. In general, we don’t like mechanical short-cuts that interfere with a student’s understanding of the material and FOIL is one of the worst.

Example 0.5.1. Perform the indicated operations and simplify.

1. $(3x^2 - 2x + 1) - (7x - 3)$
2. $4xz^2 - 3z(xz - x + 4)$
3. $(2t + 1)(3t - 7)$
4. $(3y - \sqrt[3]{2})(9y^2 + 3\sqrt[3]{2}y + \sqrt[3]{4})$
5. $\left(4w - \frac{1}{2}\right)^2$
6. $[2(x + h) - (x + h)^2] - (2x - x^2)$

Solution.

1. We begin ‘distributing the negative’ as indicated on page 20 in Section 0.2, then we rearrange and combine like term:

$$\begin{aligned} (3x^2 - 2x + 1) - (7x - 3) &= 3x^2 - 2x + 1 - 7x + 3 && \text{Distribute} \\ &= 3x^2 - 2x - 7x + 1 + 3 && \text{Rearrange terms} \\ &= 3x^2 - 9x + 4 && \text{Combine like terms} \end{aligned}$$

Our answer is $3x^2 - 9x + 4$.

2. Following in our footsteps from the previous example, we first distribute the $-3z$ through, then rearrange and combine like terms.

$$\begin{aligned} 4xz^2 - 3z(xz - x + 4) &= 4xz^2 - 3z(xz) + 3z(x) - 3z(4) && \text{Distribute} \\ &= 4xz^2 - 3xz^2 + 3xz - 12z && \text{Multiply} \\ &= xz^2 + 3xz - 12z && \text{Combine like terms} \end{aligned}$$

We get our final answer: $xz^2 + 3xz - 12z$

3. At last, we have a chance to use our F.O.I.L. technique:

$$\begin{aligned} (2t + 1)(3t - 7) &= (2t)(3t) + (2t)(-7) + (1)(3t) + (1)(-7) && \text{F.O.I.L.} \\ &= 6t^2 - 14t + 3t - 7 && \text{Multiply} \\ &= 6t^2 - 11t - 7 && \text{Combine like terms} \end{aligned}$$

We get $6t^2 - 11t - 7$ as our final answer.

4. We use the Generalized Distributive Property here, multiplying each term in the second quantity first by $3y$, then by $-\sqrt[3]{2}$:

$$\begin{aligned} (3y - \sqrt[3]{2})(9y^2 + 3\sqrt[3]{2}y + \sqrt[3]{4}) &= 3y(9y^2) + 3y(3\sqrt[3]{2}y) + 3y(\sqrt[3]{4}) \\ &\quad - \sqrt[3]{2}(9y^2) - \sqrt[3]{2}(3\sqrt[3]{2}y) - \sqrt[3]{2}(\sqrt[3]{4}) \\ &= 27y^3 + 9y^2\sqrt[3]{2} + 3y\sqrt[3]{4} - 9y^2\sqrt[3]{2} - 3y\sqrt[3]{4} - \sqrt[3]{8} \\ &= 27y^3 + 9y^2\sqrt[3]{2} - 9y^2\sqrt[3]{2} + 3y\sqrt[3]{4} - 3y\sqrt[3]{4} - 2 \\ &= 27y^3 - 2 \end{aligned}$$

To our surprise and delight, this product reduces to $27y^3 - 2$.

5. Since exponents do **not** distribute across powers,² $(4w - \frac{1}{2})^2 \neq (4w)^2 - (\frac{1}{2})^2$. (We know you knew that.) Instead, we proceed as follows:

$$\begin{aligned}
 \left(4w - \frac{1}{2}\right)^2 &= \left(4w - \frac{1}{2}\right) \left(4w - \frac{1}{2}\right) \\
 &= (4w)(4w) + (4w)\left(-\frac{1}{2}\right) + \left(-\frac{1}{2}\right)(4w) + \left(-\frac{1}{2}\right)\left(-\frac{1}{2}\right) && \text{F.O.I.L.} \\
 &= 16w^2 - 2w - 2w + \frac{1}{4} && \text{Multiply} \\
 &= 16w^2 - 4w + \frac{1}{4} && \text{Combine like terms}
 \end{aligned}$$

Our (correct) final answer is $16w^2 - 4w + \frac{1}{4}$.

6. Our last example has two levels of grouping symbols. We begin simplifying the quantity inside the brackets, squaring out the binomial $(x + h)^2$ in the same way we expanded the square in our last example:

$$(x + h)^2 = (x + h)(x + h) = (x)(x) + (x)(h) + (h)(x) + (h)(h) = x^2 + 2xh + h^2$$

When we substitute this into our expression, we envelope it in parentheses, as usual, so we don't forget to distribute the negative.

$$\begin{aligned}
 [2(x + h) - (x + h)^2] - (2x - x^2) &= [2(x + h) - (x^2 + 2xh + h^2)] - (2x - x^2) && \text{Substitute} \\
 &= [2x + 2h - x^2 - 2xh - h^2] - (2x - x^2) && \text{Distribute} \\
 &= 2x + 2h - x^2 - 2xh - h^2 - 2x + x^2 && \text{Distribute} \\
 &= 2x - 2x + 2h - x^2 + x^2 - 2xh - h^2 && \text{Rearrange terms} \\
 &= 2h - 2xh - h^2 && \text{Combine like terms}
 \end{aligned}$$

We find no like terms in $2h - 2xh - h^2$ so we are finished. \square

We conclude our discussion of polynomial multiplication by showcasing two special products which happen often enough they should be committed to memory.

Theorem 0.7. Special Products: Let a and b be real numbers:

- **Perfect Square:** $(a + b)^2 = a^2 + 2ab + b^2$ and $(a - b)^2 = a^2 - 2ab + b^2$
- **Difference of Two Squares:** $(a - b)(a + b) = a^2 - b^2$

The formulas in Theorem 0.7 can be verified by working through the multiplication.³

²See the remarks following the Properties of Exponents on 27.

³These are both special cases of F.O.I.L.

0.5.2 POLYNOMIAL LONG DIVISION.

We now turn our attention to polynomial long division. Dividing two polynomials follows the same algorithm, in principle, as dividing two natural numbers so we review that process first. Suppose we wished to divide 2585 by 79. The standard division tableau is given below.

$$\begin{array}{r} 32 \\ 79 \overline{) 2585} \\ \underline{-237} \\ 215 \\ \underline{-158} \\ 57 \end{array}$$

In this case, 79 is called the **divisor**, 2585 is called the **dividend**, 32 is called the **quotient** and 57 is called the **remainder**. We can check our answer by showing:

$$\text{dividend} = (\text{divisor})(\text{quotient}) + \text{remainder}$$

or in this case, $2585 = (79)(32) + 57$. We hope that the long division tableau evokes warm, fuzzy memories of your formative years as opposed to feelings of hopelessness and frustration. If you experience the latter, keep in mind that the Division Algorithm essentially is a two-step process, iterated over and over again. First, we guess the number of times the divisor goes into the dividend and then we subtract off our guess. We repeat those steps with what's left over until what's left over (the remainder) is less than what we started with (the divisor). That's all there is to it!

The division algorithm for polynomials has the same basic two steps but when we subtract polynomials, we must take care to subtract *like terms* only. As a transition to polynomial division, let's write out our previous division tableau in expanded form.

$$\begin{array}{r} 3 \cdot 10 + 2 \\ 7 \cdot 10 + 9 \overline{) 2 \cdot 10^3 + 5 \cdot 10^2 + 8 \cdot 10 + 5} \\ \underline{-(2 \cdot 10^3 + 3 \cdot 10^2 + 7 \cdot 10)} \downarrow \\ 2 \cdot 10^2 + 1 \cdot 10 + 5 \\ \underline{-(1 \cdot 10^2 + 5 \cdot 10 + 8)} \\ 5 \cdot 10 + 7 \end{array}$$

Written this way, we see that when we line up the digits we are really lining up the coefficients of the corresponding powers of 10 - much like how we'll have to keep the powers of x lined up in the same columns. The big difference between polynomial division and the division of natural numbers is that the value of x is an unknown quantity. So unlike using the known value of 10, when we subtract there can be no regrouping of coefficients as in our previous example. (The subtraction $215 - 158$ requires us to 'regroup' or 'borrow' from the tens digit, then the hundreds digit.) This actually makes polynomial division easier.⁴ Before we dive into examples, we first state a theorem telling us when we can divide two polynomials, and what to expect when we do so.

⁴In our opinion - you can judge for yourself.

Theorem 0.8. Polynomial Division: Let d and p be nonzero polynomials where the degree of p is greater than or equal to the degree of d . There exist two unique polynomials, q and r , such that $p = d \cdot q + r$, where either $r = 0$ or the degree of r is strictly less than the degree of d .

Essentially, Theorem 0.8 tells us that we can divide polynomials whenever the degree of the divisor is less than or equal to the degree of the dividend. We know we're done with the division when the polynomial left over (the remainder) has a degree strictly less than the divisor. It's time to walk through a few examples to refresh your memory.

Example 0.5.2. Perform the indicated division. Check your answer by showing

$$\text{dividend} = (\text{divisor})(\text{quotient}) + \text{remainder}$$

1. $(x^3 + 4x^2 - 5x - 14) \div (x - 2)$
2. $(2t + 7) \div (3t - 4)$
3. $(6y^2 - 1) \div (2y + 5)$
4. $(w^3) \div (w^2 - \sqrt{2})$.

Solution.

1. To begin $(x^3 + 4x^2 - 5x - 14) \div (x - 2)$, we divide the first term in the dividend, namely x^3 , by the first term in the divisor, namely x , and get $\frac{x^3}{x} = x^2$. This then becomes the first term in the quotient. We proceed as in regular long division at this point: we multiply the entire divisor, $x - 2$, by this first term in the quotient to get $x^2(x - 2) = x^3 - 2x^2$. We then subtract this result from the dividend.

$$\begin{array}{r} x^2 \\ x-2 \overline{) x^3 + 4x^2 - 5x - 14} \\ \underline{-(x^3 - 2x^2)} \quad \downarrow \\ 6x^2 - 5x \end{array}$$

Now we 'bring down' the next term of the quotient, namely $-5x$, and repeat the process. We divide $\frac{6x^2}{x} = 6x$, and add this to the quotient polynomial, multiply it by the divisor (which yields $6x(x - 2) = 6x^2 - 12x$) and subtract.

$$\begin{array}{r} x^2 + 6x \\ x-2 \overline{) x^3 + 4x^2 - 5x - 14} \\ \underline{-(x^3 - 2x^2)} \quad \downarrow \\ 6x^2 - 5x \quad \downarrow \\ \underline{-(6x^2 - 12x)} \quad \downarrow \\ 7x - 14 \end{array}$$

Finally, we 'bring down' the last term of the dividend, namely -14 , and repeat the process. We divide $\frac{7x}{x} = 7$, add this to the quotient, multiply it by the divisor (which yields $7(x - 2) =$

$7x - 14$) and subtract.

$$\begin{array}{r}
 x^2 + 6x + 7 \\
 x-2 \overline{) x^3 + 4x^2 - 5x - 14} \\
 \underline{-(x^3 - 2x^2)} \\
 6x^2 - 5x \\
 \underline{-(6x^2 - 12x)} \\
 7x - 14 \\
 \underline{-(7x - 14)} \\
 0
 \end{array}$$

In this case, we get a quotient of $x^2 + 6x + 7$ with a remainder of 0. To check our answer, we compute

$$(x - 2)(x^2 + 6x + 7) + 0 = x^3 + 6x^2 + 7x - 2x^2 - 12x - 14 = x^3 + 4x^2 - 5x - 14 \checkmark$$

2. To compute $(2t + 7) \div (3t - 4)$, we start as before. We find $\frac{2t}{3t} = \frac{2}{3}$, so that becomes the first (and only) term in the quotient. We multiply the divisor $(3t - 4)$ by $\frac{2}{3}$ and get $2t - \frac{8}{3}$. We subtract this from the divided and get $\frac{29}{3}$.

$$\begin{array}{r}
 \frac{2}{3} \\
 3t-4 \overline{) 2t + 7} \\
 \underline{-(2t - \frac{8}{3})} \\
 \frac{29}{3}
 \end{array}$$

Our answer is $\frac{2}{3}$ with a remainder of $\frac{29}{3}$. To check our answer, we compute

$$(3t - 4) \left(\frac{2}{3} \right) + \frac{29}{3} = 2t - \frac{8}{3} + \frac{29}{3} = 2t + \frac{21}{3} = 2t + 7 \checkmark$$

3. When we set-up the tableau for $(6y^2 - 1) \div (2y + 5)$, we must first issue a ‘placeholder’ for the ‘missing’ y -term in the dividend, $6y^2 - 1 = 6y^2 + 0y - 1$. We then proceed as before. Since $\frac{6y^2}{2y} = 3y$, $3y$ is the first term in our quotient. We multiply $(2y + 5)$ times $3y$ and subtract it

from the dividend. We bring down the -1 , and repeat.

$$\begin{array}{r}
 3y - \frac{15}{2} \\
 2y+5 \overline{) 6y^2 + 0y - 1} \\
 \underline{-(6y^2 + 15y)} \quad \downarrow \\
 -15y - 1 \\
 \underline{-(-15y - \frac{75}{2})} \\
 \frac{73}{2}
 \end{array}$$

Our answer is $3y - \frac{15}{2}$ with a remainder of $\frac{73}{2}$. To check our answer, we compute:

$$(2y + 5) \left(3y - \frac{15}{2} \right) + \frac{73}{2} = 6y^2 - 15y + 15y - \frac{75}{2} + \frac{73}{2} = 6y^2 - 1 \checkmark$$

4. For our last example, we need ‘placeholders’ for both the divisor $w^2 - \sqrt{2} = w^2 + 0w - \sqrt{2}$ and the dividend $w^3 = w^3 + 0w^2 + 0w + 0$. The first term in the quotient is $\frac{w^3}{w^2} = w$, and when we multiply and subtract this from the dividend, we’re left with just $0w^2 + w\sqrt{2} + 0 = w\sqrt{2}$.

$$\begin{array}{r}
 w \\
 w^2+0w-\sqrt{2} \overline{) w^3 + 0w^2 + 0w + 0} \\
 \underline{-(w^3 + 0w^2 - w\sqrt{2})} \quad \downarrow \\
 0w^2 + w\sqrt{2} + 0
 \end{array}$$

Since the degree of $w\sqrt{2}$ (which is 1) is less than the degree of the divisor (which is 2), we are done.⁵ Our answer is w with a remainder of $w\sqrt{2}$. To check, we compute:

$$(w^2 - \sqrt{2})w + w\sqrt{2} = w^3 - w\sqrt{2} + w\sqrt{2} = w^3 \checkmark \quad \square$$

⁵Since $\frac{0w^2}{w^2} = 0$, we could proceed, write our quotient as $w + 0$, and move on... but even pedants have limits.

0.5.3 EXERCISES

In Exercises 1 - 15, perform the indicated operations and simplify.

1. $(4 - 3x) + (3x^2 + 2x + 7)$
2. $t^2 + 4t - 2(3 - t)$
3. $q(200 - 3q) - (5q + 500)$
4. $(3y - 1)(2y + 1)$
5. $\left(3 - \frac{x}{2}\right)(2x + 5)$
6. $-(4t + 3)(t^2 - 2)$
7. $2w(w^3 - 5)(w^3 + 5)$
8. $(5a^2 - 3)(25a^4 + 15a^2 + 9)$
9. $(x^2 - 2x + 3)(x^2 + 2x + 3)$
10. $(\sqrt{7} - z)(\sqrt{7} + z)$
11. $(x - \sqrt[3]{5})^3$
12. $(x - \sqrt[3]{5})(x^2 + x\sqrt[3]{5} + \sqrt[3]{25})$
13. $(w - 3)^2 - (w^2 + 9)$
14. $(x + h)^2 - 2(x + h) - (x^2 - 2x)$
15. $(x - [2 + \sqrt{5}])(x - [2 - \sqrt{5}])$

In Exercises 16 - 27, perform the indicated division. Check your answer by showing

$$\text{dividend} = (\text{divisor})(\text{quotient}) + \text{remainder}$$

16. $(5x^2 - 3x + 1) \div (x + 1)$
17. $(3y^2 + 6y - 7) \div (y - 3)$
18. $(6w - 3) \div (2w + 5)$
19. $(2x + 1) \div (3x - 4)$
20. $(t^2 - 4) \div (2t + 1)$
21. $(w^3 - 8) \div (5w - 10)$
22. $(2x^2 - x + 1) \div (3x^2 + 1)$
23. $(4y^4 + 3y^2 + 1) \div (2y^2 - y + 1)$
24. $w^4 \div (w^3 - 2)$
25. $(5t^3 - t + 1) \div (t^2 + 4)$
26. $(t^3 - 4) \div (t - \sqrt[3]{4})$
27. $(x^2 - 2x - 1) \div (x - [1 - \sqrt{2}])$

In Exercises 28 - 33 verify the given formula by showing the left hand side of the equation simplifies to the right hand side of the equation.

28. **Perfect Cube:** $(a + b)^3 = a^3 + 3a^2b + 3ab^2 + b^3$
29. **Difference of Cubes:** $(a - b)(a^2 + ab + b^2) = a^3 - b^3$
30. **Sum of Cubes:** $(a + b)(a^2 - ab + b^2) = a^3 + b^3$
31. **Perfect Quartic:** $(a + b)^4 = a^4 + 4a^3b + 6a^2b^2 + 4ab^3 + b^4$
32. **Difference of Quartics:** $(a - b)(a + b)(a^2 + b^2) = a^4 - b^4$
33. **Sum of Quartics:** $(a^2 + ab\sqrt{2} + b^2)(a^2 - ab\sqrt{2} + b^2) = a^4 + b^4$
34. With help from your classmates, determine under what conditions $(a + b)^2 = a^2 + b^2$. What about $(a + b)^3 = a^3 + b^3$? In general, when does $(a + b)^n = a^n + b^n$ for a natural number $n \geq 2$?

0.5.4 ANSWERS

- | | | |
|---|---|----------------------------|
| 1. $3x^2 - x + 11$ | 2. $t^2 + 6t - 6$ | 3. $-3q^2 + 195q - 500$ |
| 4. $6y^2 + y - 1$ | 5. $-x^2 + \frac{7}{2}x + 15$ | 6. $-4t^3 - 3t^2 + 8t + 6$ |
| 7. $2w^7 - 50w$ | 8. $125a^6 - 27$ | 9. $x^4 + 2x^2 + 9$ |
| 10. $7 - z^2$ | 11. $x^3 - 3x^2\sqrt[3]{5} + 3x\sqrt[3]{25} - 5$ | 12. $x^3 - 5$ |
| 13. $-6w$ | 14. $h^2 + 2xh - 2h$ | 15. $x^2 - 4x - 1$ |
| 16. quotient: $5x - 8$, remainder: 9 | 17. quotient: $3y + 15$, remainder: 38 | |
| 18. quotient: 3, remainder: 18 | 19. quotient: $\frac{2}{3}$, remainder: $\frac{11}{3}$ | |
| 20. quotient: $\frac{t}{2} - \frac{1}{4}$, remainder: $-\frac{15}{4}$ | 21. quotient: $\frac{w^2}{5} + \frac{2w}{5} + \frac{4}{5}$, remainder: 0 | |
| 22. quotient: $\frac{2}{3}$, remainder: $-x + \frac{1}{3}$ | 23. quotient: $2y^2 + y + 1$, remainder: 0 | |
| 24. quotient: w , remainder: $2w$ | 25. quotient: $5t$, remainder: $-21t + 1$ | |
| 26. quotient: ⁶ $t^2 + t\sqrt[3]{4} + 2\sqrt[3]{2}$, remainder: 0 | 27. quotient: $x - 1 - \sqrt{2}$, remainder: 0 | |

⁶Note: $\sqrt[3]{16} = 2\sqrt[3]{2}$.

0.6 FACTORING

Now that we have reviewed the basics of polynomial arithmetic it's time to review the basic techniques of factoring polynomial expressions. Our goal is to apply these techniques to help us solve certain specialized classes of non-linear equations. Given that 'factoring' literally means to resolve a product into its factors, it is, in the purest sense, 'undoing' multiplication. If this sounds like division to you then you've been paying attention. Let's start with a numerical example.

Suppose we are asked to factor 16337. We could write $16337 = 16337 \cdot 1$, and while this is technically a factorization of 16337, it's probably not an answer the poser of the question would accept. Usually, when we're asked to factor a natural number, we are being asked to resolve it into to a product of so-called 'prime' numbers.¹ Recall that **prime numbers** are defined as natural numbers whose only (natural number) factors are themselves and 1. They are, in essence, the 'building blocks' of natural numbers as far as multiplication is concerned. Said differently, we can build - via multiplication - any natural number given enough primes. So how do we find the prime factors of 16337? We start by dividing each of the primes: 2, 3, 5, 7, etc., into 16337 until we get a remainder of 0. Eventually, we find that $16337 \div 17 = 961$ with a remainder of 0, which means $16337 = 17 \cdot 961$. So factoring and division are indeed closely related - factors of a number are precisely the divisors of that number which produce a zero remainder.² We continue our efforts to see if 961 can be factored down further, and we find that $961 = 31 \cdot 31$. Hence, 16337 can be 'completely factored' as $17 \cdot 31^2$. (This factorization is called the **prime factorization** of 16337.)

In factoring natural numbers, our building blocks are prime numbers, so to be completely factored means that every number used in the factorization of a given number is prime. One of the challenges when it comes to factoring polynomial expressions is to explain what it means to be 'completely factored'. In this section, our 'building blocks' for factoring polynomials are 'irreducible' polynomials as defined below.

Definition 0.14. A polynomial is said to be **irreducible** if it cannot be written as the product of polynomials of lower degree.

While Definition 0.14 seems straightforward enough, sometimes a greater level of specificity is required. For example, $x^2 - 3 = (x - \sqrt{3})(x + \sqrt{3})$. While $x - \sqrt{3}$ and $x + \sqrt{3}$ are perfectly fine polynomials, factoring which requires irrational numbers is usually saved for a more advanced treatment of factoring.³ For now, we will restrict ourselves to factoring using rational coefficients. So, while the polynomial $x^2 - 3$ can be factored using irrational numbers, it is called irreducible **over the rationals**, since there are no polynomials with *rational* coefficients of smaller degree which can be used to factor it.⁴

Since polynomials involve terms, the first step in any factoring strategy involves pulling out factors which are common to all of the terms. For example, in the polynomial $18x^2y^3 - 54x^3y^2 - 12xy^2$, each coefficient is a multiple of 6 so we can begin the factorization as $6(3x^2y^3 - 9x^3y^2 - 2xy^2)$.

¹As mentioned in Section 0.2, this is possible, in only one way, thanks to the [Fundamental Theorem of Arithmetic](#).

²We'll refer back to this when we get to Section 3.2.

³See Section 3.3.

⁴If this isn't immediately obvious, don't worry - in some sense, it shouldn't be. We'll talk more about this later.

The remaining coefficients: 3, 9 and 2, have no common factors so 6 was the greatest common factor. What about the variables? Each term contains an x , so we can factor an x from each term. When we do this, we are effectively dividing each term by x which means the exponent on x in each term is reduced by 1: $6x(3xy^3 - 9x^2y^2 - 2y^2)$. Next, we see that each term has a factor of y in it. In fact, each term has at least *two* factors of y in it, since the lowest exponent on y in each term is 2. This means that we can factor y^2 from each term. Again, factoring out y^2 from each term is tantamount to dividing each term by y^2 so the exponent on y in each term is reduced by *two*: $6xy^2(3xy - 9x^2 - 2)$. Just like we checked our division by multiplication in the previous section, we can check our factoring here by multiplication, too. $6xy^2(3xy - 9x^2 - 2) = (6xy^2)(3xy) - (6xy^2)(9x^2) - (6xy^2)(2) = 18x^2y^3 - 54x^3y^2 - 12xy^2 \checkmark$. We summarize how to find the Greatest Common Factor (G.C.F.) of a polynomial expression below.

Finding the G.C.F. of a Polynomial Expression

- If the coefficients are integers, find the G.C.F. of the coefficients.
NOTE 1: If all of the coefficients are negative, consider the negative as part of the G.C.F..
NOTE 2: If the coefficients involve fractions, get a common denominator, combine numerators, reduce to lowest terms and apply this step to the polynomial in the numerator.
- If a variable is common to all of the terms, the G.C.F. contains that variable to the smallest exponent which appears among the terms.

For example, to factor $-\frac{3}{5}z^3 - 6z^2$, we would first get a common denominator and factor as:

$$-\frac{3}{5}z^3 - 6z^2 = \frac{-3z^3 - 30z^2}{5} = \frac{-3z^2(z + 10)}{5} = -\frac{3z^2(z + 10)}{5}$$

We now list some common factoring formulas, each of which can be verified by multiplying out the right side of the equation. While they all should look familiar - this is a review section after all - some should look more familiar than others since they appeared as ‘special product’ formulas in the previous section.

Common Factoring Formulas

- **Perfect Square Trinomials:** $a^2 + 2ab + b^2 = (a + b)^2$ and $a^2 - 2ab + b^2 = (a - b)^2$
- **Difference of Two Squares:** $a^2 - b^2 = (a - b)(a + b)$
NOTE: In general, the sum of squares, $a^2 + b^2$ is irreducible over the rationals.
- **Sum of Two Cubes:** $a^3 + b^3 = (a + b)(a^2 - ab + b^2)$
NOTE: In general, $a^2 - ab + b^2$ is irreducible over the rationals.
- **Difference of Two Cubes:** $a^3 - b^3 = (a - b)(a^2 + ab + b^2)$
NOTE: In general, $a^2 + ab + b^2$ is irreducible over the rationals.

Our next example gives us practice with these formulas.

Example 0.6.1. Factor the following polynomials completely over the rationals. That is, write each polynomial as a product of polynomials of lowest degree which are irreducible over the rationals.

1. $18x^2 - 48x + 32$
2. $64y^2 - 1$
3. $75t^4 + 30t^3 + 3t^2$
4. $w^4z - wz^4$
5. $81 - 16t^4$
6. $x^6 - 64$

Solution.

1. Our first step is to factor out the G.C.F. which in this case is 2. To match what is left with one of the special forms, we rewrite $9x^2 = (3x)^2$ and $16 = 4^2$. Since the ‘middle’ term is $-24x = -2(4)(3x)$, we see that we have a perfect square trinomial.

$$\begin{aligned} 18x^2 - 48x + 32 &= 2(9x^2 - 24x + 16) && \text{Factor out G.C.F.} \\ &= 2((3x)^2 - 2(4)(3x) + (4)^2) \\ &= 2(3x - 4)^2 && \text{Perfect Square Trinomial: } a = 3x, b = 4 \end{aligned}$$

Our final answer is $2(3x - 4)^2$. To check, we multiply out $2(3x - 4)^2$ to show that it equals $18x^2 - 48x + 32$.

2. For $64y^2 - 1$, we note that the G.C.F. of the terms is just 1, so there is nothing (of substance) to factor out of both terms. Since $64y^2 - 1$ is the difference of two terms, one of which is a square, we look to the Difference of Squares Formula for inspiration. By identifying $64y^2 = (8y)^2$ and $1 = 1^2$, we get

$$\begin{aligned} 64y^2 - 1 &= (8y)^2 - 1^2 \\ &= (8y - 1)(8y + 1) && \text{Difference of Squares, } a = 8y, b = 1 \end{aligned}$$

As before, we can check our answer by multiplying out $(8y - 1)(8y + 1)$ to show that it equals $64y^2 - 1$.

3. The G.C.F. of the terms in $75t^4 + 30t^3 + 3t^2$ is $3t^2$, so we factor that out first. We identify what remains as a perfect square trinomial:

$$\begin{aligned} 75t^4 + 30t^3 + 3t^2 &= 3t^2(25t^2 + 10t + 1) && \text{Factor out G.C.F.} \\ &= 3t^2((5t)^2 + 2(1)(5t) + 1^2) \\ &= 3t^2(5t + 1)^2 && \text{Perfect Square Trinomial, } a = 5t, b = 1 \end{aligned}$$

Our final answer is $3t^2(5t + 1)^2$, which the reader is invited to check.

4. For $w^4z - wz^4$, we identify the G.C.F. as wz and once we factor it out a difference of cubes is revealed:

$$\begin{aligned} w^4z - wz^4 &= wz(w^3 - z^3) && \text{Factor out G.C.F.} \\ &= wz(w - z)(w^2 + wz + z^2) && \text{Difference of Cubes, } a = w, b = z \end{aligned}$$

Our final answer is $wz(w - z)(w^2 + wz + z^2)$. The reader is strongly encouraged to multiply this out to see that it reduces to $w^4z - wz^4$.

5. The G.C.F. of the terms in $81 - 16t^4$ is just 1 so there is nothing of substance to factor out from both terms. With just a difference of two terms, we are limited to fitting this polynomial into either the Difference of Two Squares or Difference of Two Cubes formula. Since the variable here is t^4 , and 4 is a multiple of 2, we can think of $t^4 = (t^2)^2$. This means that we can write $16t^4 = (4t^2)^2$ which is a perfect square. (Since 4 is not a multiple of 3, we cannot write t^4 as a perfect cube of a polynomial.) Identifying $81 = 9^2$ and $16t^4 = (4t^2)^2$, we apply the Difference of Squares Formula to get:

$$\begin{aligned} 81 - 16t^4 &= 9^2 - (4t^2)^2 \\ &= (9 - 4t^2)(9 + 4t^2) \quad \text{Difference of Squares, } a = 9, b = 4t^2 \end{aligned}$$

At this point, we have an opportunity to proceed further. Identifying $9 = 3^2$ and $4t^2 = (2t)^2$, we see that we have another difference of squares in the first quantity, which we can reduce. (The sum of two squares in the second quantity cannot be factored over the rationals.)

$$\begin{aligned} 81 - 16t^4 &= (9 - 4t^2)(9 + 4t^2) \\ &= (3^2 - (2t)^2)(9 + 4t^2) \\ &= (3 - 2t)(3 + 2t)(9 + 4t^2) \quad \text{Difference of Squares, } a = 3, b = 2t \end{aligned}$$

As always, the reader is encouraged to multiply out $(3 - 2t)(3 + 2t)(9 + 4t^2)$ to check the result.

6. With a G.C.F. of 1 and just two terms, $x^6 - 64$ is a candidate for both the Difference of Squares and the Difference of Cubes formulas. Notice that we can identify $x^6 = (x^3)^2$ and $64 = 8^2$ (both perfect squares), but also $x^6 = (x^2)^3$ and $64 = 4^3$ (both perfect cubes). If we follow the Difference of Squares approach, we get:

$$\begin{aligned} x^6 - 64 &= (x^3)^2 - 8^2 \\ &= (x^3 - 8)(x^3 + 8) \quad \text{Difference of Squares, } a = x^3 \text{ and } b = 8 \end{aligned}$$

At this point, we have an opportunity to use both the Difference and Sum of Cubes formulas:

$$\begin{aligned} x^6 - 64 &= (x^3 - 2^3)(x^3 + 2^3) \\ &= (x - 2)(x^2 + 2x + 2^2)(x + 2)(x^2 - 2x + 2^2) \quad \text{Sum / Difference of Cubes, } a = x, b = 2 \\ &= (x - 2)(x + 2)(x^2 - 2x + 4)(x^2 + 2x + 4) \quad \text{Rearrange factors} \end{aligned}$$

From this approach, our final answer is $(x - 2)(x + 2)(x^2 - 2x + 4)(x^2 + 2x + 4)$.

Following the Difference of Cubes Formula approach, we get

$$\begin{aligned} x^6 - 64 &= (x^2)^3 - 4^3 \\ &= (x^2 - 4)((x^2)^2 + 4x^2 + 4^2) \quad \text{Difference of Cubes, } a = x^2, b = 4 \\ &= (x^2 - 4)(x^4 + 4x^2 + 16) \end{aligned}$$

At this point, we recognize $x^2 - 4$ as a difference of two squares:

$$\begin{aligned} x^6 - 64 &= (x^2 - 2^2)(x^4 + 4x^2 + 16) \\ &= (x - 2)(x + 2)(x^4 + 4x^2 + 16) \quad \text{Difference of Squares, } a = x, b = 2 \end{aligned}$$

Unfortunately, the remaining factor $x^4 + 4x^2 + 16$ is not a perfect square trinomial - the middle term would have to be $8x^2$ for this to work - so our final answer using this approach is $(x - 2)(x + 2)(x^4 + 4x^2 + 16)$. This isn't as factored as our result from the Difference of Squares approach which was $(x - 2)(x + 2)(x^2 - 2x + 4)(x^2 + 2x + 4)$. While it is true that $x^4 + 4x^2 + 16 = (x^2 - 2x + 4)(x^2 + 2x + 4)$, there is no 'intuitive' way to motivate this factorization at this point.⁵ The moral of the story? When given the option between using the Difference of Squares and Difference of Cubes, start with the Difference of Squares. Our final answer to this problem is $(x - 2)(x + 2)(x^2 - 2x + 4)(x^2 + 2x + 4)$. The reader is strongly encouraged to show that this reduces down to $x^6 - 64$ after performing all of the multiplication. \square

The formulas on page 72, while useful, can only take us so far, so we need to review some more advanced factoring strategies.

Advanced Factoring Formulas

- **'un-F.O.I.L.ing'**: Given a trinomial $Ax^2 + Bx + C$, try to reverse the F.O.I.L. process. That is, find a, b, c and d such that $Ax^2 + Bx + C = (ax + b)(cx + d)$.

NOTE: This means $ac = A$, $bd = C$ and $B = ad + bc$.

- **Factor by Grouping:** If the expression contains four terms with no common factors among the four terms, try 'factor by grouping':

$$ac + bc + ad + bd = (a + b)c + (a + b)d = (a + b)(c + d)$$

The techniques of 'un-F.O.I.L.ing' and 'factoring by grouping' are difficult to describe in general but should make sense to you with enough practice. Be forewarned - like all 'Rules of Thumb', these strategies work just often enough to be useful, but you can be sure there are exceptions which will defy any advice given here and will require some 'inspiration' to solve.⁶ Even though Chapter 3 will give us more powerful factoring methods, we'll find that, in the end, there is no single algorithm for factoring which works for every polynomial. In other words, there will be times when you just have to try something and see what happens.

Example 0.6.2. Factor the following polynomials completely over the integers.⁷

1. $x^2 - x - 6$

2. $2t^2 - 11t + 5$

3. $36 - 11y - 12y^2$

4. $18xy^2 - 54xy - 180x$

5. $2t^3 - 10t^2 + 3t - 15$

6. $x^4 + 4x^2 + 16$

⁵Of course, this begs the question, "How do we know $x^2 - 2x + 4$ and $x^2 + 2x + 4$ are irreducible?" (We were told so on page 72, but no reason was given.) Stay tuned! We'll get back to this in due course.

⁶Jeff will be sure to pepper the Exercises with these.

⁷This means that all of the coefficients in the factors will be integers. In a rare departure from form, Carl decided to avoid fractions in this set of examples. But don't get complacent: fractions will soon return with a vengeance.

Solution.

1. The G.C.F. of the terms $x^2 - x - 6$ is 1 and $x^2 - x - 6$ isn't a perfect square trinomial (Think about why not.) so we try to reverse the F.O.I.L. process and look for integers a , b , c and d such that $(ax + b)(cx + d) = x^2 - x - 6$. To get started, we note that $ac = 1$. Since a and c are meant to be integers, that leaves us with either a and c both being 1, or a and c both being -1 . We'll go with $a = c = 1$, since we can factor⁸ the negatives into our choices for b and d . This yields $(x + b)(x + d) = x^2 - x - 6$. Next, we use the fact that $bd = -6$. The product is negative so we know that one of b or d is positive and the other is negative. Since b and d are integers, one of b or d is ± 1 and the other is ∓ 6 OR one of b or d is ± 2 and the other is ∓ 3 . After some guessing and checking,⁹ we find that $x^2 - x - 6 = (x + 2)(x - 3)$.
2. As with the previous example, we check the G.C.F. of the terms in $2t^2 - 11t + 5$, determine it to be 1 and see that the polynomial doesn't fit the pattern for a perfect square trinomial. We now try to find integers a , b , c and d such that $(at + b)(ct + d) = 2t^2 - 11t + 5$. Since $ac = 2$, we have that one of a or c is 2, and the other is 1. (Once again, we ignore the negative options.) At this stage, there is nothing really distinguishing a from c so we choose $a = 2$ and $c = 1$. Now we look for b and d so that $(2t + b)(t + d) = 2t^2 - 11t + 5$. We know $bd = 5$ so one of b or d is ± 1 and the other ± 5 . Given that bd is positive, b and d must have the same sign. The negative middle term $-11t$ guides us to guess $b = -1$ and $d = -5$ so that we get $(2t - 1)(t - 5) = 2t^2 - 11t + 5$. We verify our answer by multiplying.¹⁰
3. Once again, we check for a nontrivial G.C.F. and see if $36 - 11y - 12y^2$ fits the pattern of a perfect square. Twice disappointed, we rewrite $36 - 11y - 12y^2 = -12y^2 - 11y + 36$ for notational convenience. We now look for integers a , b , c and d such that $-12y^2 - 11y + 36 = (ay + b)(cy + d)$. Since $ac = -12$, we know that one of a or c is ± 1 and the other ± 12 OR one of them is ± 2 and the other is ± 6 OR one of them is ± 3 while the other is ± 4 . Since their product is -12 , however, we know one of them is positive, while the other is negative. To make matters worse, the constant term 36 has its fair share of factors, too. Our answers for b and d lie among the pairs ± 1 and ± 36 , ± 2 and ± 18 , ± 4 and ± 9 , or ± 6 . Since we know one of a or c will be negative, we can simplify our choices for b and d and just look at the positive possibilities. After some guessing and checking,¹¹ we find $(-3y + 4)(4y + 9) = -12y^2 - 11y + 36$.
4. Since the G.C.F. of the terms in $18xy^2 - 54xy - 180x$ is $18x$, we begin the problem by factoring it out first: $18xy^2 - 54xy - 180x = 18x(y^2 - 3y - 10)$. We now focus our attention on $y^2 - 3y - 10$. We can take a and c to both be 1 which yields $(y + b)(y + d) = y^2 - 3y - 10$. Our choices for b and d are among the factor pairs of -10 : ± 1 and ± 10 or ± 2 and ± 5 , where one of b or d is positive and the other is negative. We find $(y - 5)(y + 2) = y^2 - 3y - 10$. Our final answer is $18xy^2 - 54xy - 180x = 18x(y - 5)(y + 2)$.

⁸Pun intended!

⁹The authors have seen some strange gimmicks that allegedly help students with this step. We don't like them so we're sticking with good old-fashioned guessing and checking.

¹⁰That's the 'checking' part of 'guessing and checking'.

¹¹Some of these guesses can be more 'educated' than others. Since the middle term is relatively 'small,' we don't expect the 'extreme' factors of 36 and 12 to appear, for instance.

5. Since $2t^3 - 10t^2 - 3t + 15$ has four terms, we are pretty much resigned to factoring by grouping. The strategy here is to factor out the G.C.F. from two *pairs* of terms, and see if this reveals a common factor. If we group the first two terms, we can factor out a $2t^2$ to get $2t^3 - 10t^2 = 2t^2(t - 5)$. We now try to factor something out of the last two terms that will leave us with a factor of $(t - 5)$. Sure enough, we can factor out a -3 from both: $-3t + 15 = -3(t - 5)$. Hence, we get

$$2t^3 - 10t^2 - 3t + 15 = 2t^2(t - 5) - 3(t - 5) = (2t^2 - 3)(t - 5)$$

Now the question becomes can we factor $2t^2 - 3$ over the integers? This would require integers a, b, c and d such that $(at + b)(ct + d) = 2t^2 - 3$. Since $ab = 2$ and $cd = -3$, we aren't left with many options - in fact, we really have only four choices: $(2t - 1)(t + 3)$, $(2t + 1)(t - 3)$, $(2t - 3)(t + 1)$ and $(2t + 3)(t - 1)$. None of these produces $2t^2 - 3$ - which means it's irreducible over the integers - thus our final answer is $(2t^2 - 3)(t - 5)$.

6. Our last example, $x^4 + 4x^2 + 16$, is our old friend from Example 0.6.1. As noted there, it is not a perfect square trinomial, so we could try to reverse the F.O.I.L. process. This is complicated by the fact that our highest degree term is x^4 , so we would have to look at factorizations of the form $(x + b)(x^3 + d)$ as well as $(x^2 + b)(x^2 + d)$. We leave it to the reader to show that neither of those work. This is an example of where 'trying something' pays off. Even though we've stated that it is not a perfect square trinomial, it's pretty close. Identifying $x^4 = (x^2)^2$ and $16 = 4^2$, we'd have $(x^2 + 4)^2 = x^4 + 8x^2 + 16$, but instead of $8x^2$ as our middle term, we only have $4x^2$. We could add in the extra $4x^2$ we need, but to keep the balance, we'd have to subtract it off. Doing so produces an unexpected opportunity:

$$\begin{aligned} x^4 + 4x^2 + 16 &= x^4 + 4x^2 + 16 + (4x^2 - 4x^2) && \text{Adding and subtracting the same term} \\ &= x^4 + 8x^2 + 16 - 4x^2 && \text{Rearranging terms} \\ &= (x^2 + 4)^2 - (2x)^2 && \text{Factoring perfect square trinomial} \\ &= [(x^2 + 4) - 2x][(x^2 + 4) + 2x] && \text{Difference of Squares: } a = (x^2 + 4), b = 2x \\ &= (x^2 - 2x + 4)(x^2 + 2x + 4) && \text{Rearranging terms} \end{aligned}$$

We leave it to the reader to check that neither $x^2 - 2x + 4$ nor $x^2 + 2x + 4$ factor over the integers, so we are done. \square

0.6.1 SOLVING EQUATIONS BY FACTORING

Many students wonder why they are forced to learn how to factor. Simply put, factoring is our main tool for solving the non-linear equations which arise in many of the applications of Mathematics.¹² We use factoring in conjunction with the Zero Product Property of Real Numbers which was first stated on page 19 and is given here again for reference.

The Zero Product Property of Real Numbers: If a and b are real numbers with $ab = 0$ then either $a = 0$ or $b = 0$ or both.

¹²Also known as 'story problems' or 'real-world examples'.

For example, consider the equation $6x^2 + 11x = 10$. To see how the Zero Product Property is used to help us solve this equation, we first set the equation equal to zero and then apply the techniques from Example 0.6.2:

$$\begin{array}{rcl}
 6x^2 + 11x & = & 10 \\
 6x^2 + 11x - 10 & = & 0 \quad \text{Subtract 10 from both sides} \\
 (2x + 5)(3x - 2) & = & 0 \quad \text{Factor} \\
 2x + 5 = 0 \quad \text{or} \quad 3x - 2 = 0 & & \text{Zero Product Property} \\
 x = -\frac{5}{2} \quad \text{or} \quad x = \frac{2}{3} & & a = 2x + 5, b = 3x - 2
 \end{array}$$

The reader should check that both of these solutions satisfy the original equation.

It is critical that you see the importance of setting the expression equal to 0 before factoring. Otherwise, we'd get:

$$\begin{array}{rcl}
 6x^2 + 11x & = & 10 \\
 x(6x + 11) & = & 10 \quad \text{Factor}
 \end{array}$$

What we **cannot** deduce from this equation is that $x = 10$ or $6x + 11 = 10$ or that $x = 2$ and $6x + 11 = 5$, etc.. (It's wrong and you should feel bad if you do it.) It is precisely because 0 plays such a special role in the arithmetic of real numbers (as the Additive Identity) that we can assume a factor is 0 when the product is 0. No other real number has that ability.

We summarize the **correct** equation solving strategy below.

Strategy for Solving Non-linear Equations

1. Put all of the nonzero terms on one side of the equation so that the other side is 0.
2. Factor.
3. Use the Zero Product Property of Real Numbers and set each factor equal to 0.
4. Solve each of the resulting equations.

Let's finish the section with a collection of examples in which we use this strategy.

Example 0.6.3. Solve the following equations.

1. $3x^2 = 35 - 16x$
2. $t = \frac{1 + 4t^2}{4}$
3. $(y - 1)^2 = 2(y - 1)$
4. $\frac{w^4}{3} = \frac{8w^3 - 12}{12} - \frac{w^2 - 4}{4}$
5. $z(z(18z + 9) - 50) = 25$
6. $x^4 - 8x^2 - 9 = 0$

Solution.

1. We begin by gathering all of the nonzero terms to one side getting 0 on the other and then we proceed to factor and apply the Zero Product Property.

$$\begin{aligned}
 3x^2 &= 35 - 16x \\
 3x^2 + 16x - 35 &= 0 && \text{Add } 16x, \text{ subtract } 35 \\
 (3x - 5)(x + 7) &= 0 && \text{Factor} \\
 3x - 5 = 0 &\text{ or } &x + 7 = 0 & \text{Zero Product Property} \\
 x = \frac{5}{3} &\text{ or } &x = -7 &
 \end{aligned}$$

We check our answers by substituting each of them into the original equation. Plugging in $x = \frac{5}{3}$ yields $\frac{25}{3}$ on both sides while $x = -7$ gives 147 on both sides.

2. To solve $t = \frac{1+4t^2}{4}$, we first clear fractions then move all of the nonzero terms to one side of the equation, factor and apply the Zero Product Property.

$$\begin{aligned}
 t &= \frac{1 + 4t^2}{4} \\
 4t &= 1 + 4t^2 && \text{Clear fractions (multiply by 4)} \\
 0 &= 1 + 4t^2 - 4t && \text{Subtract 4} \\
 0 &= 4t^2 - 4t + 1 && \text{Rearrange terms} \\
 0 &= (2t - 1)^2 && \text{Factor (Perfect Square Trinomial)}
 \end{aligned}$$

At this point, we get $(2t - 1)^2 = (2t - 1)(2t - 1) = 0$, so, the Zero Product Property gives us $2t - 1 = 0$ in both cases.¹³ Our final answer is $t = \frac{1}{2}$, which we invite the reader to check.

3. Following the strategy outlined above, the first step to solving $(y - 1)^2 = 2(y - 1)$ is to gather the nonzero terms on one side of the equation with 0 on the other side and factor.

$$\begin{aligned}
 (y - 1)^2 &= 2(y - 1) \\
 (y - 1)^2 - 2(y - 1) &= 0 && \text{Subtract } 2(y - 1) \\
 (y - 1)[(y - 1) - 2] &= 0 && \text{Factor out G.C.F.} \\
 (y - 1)(y - 3) &= 0 && \text{Simplify} \\
 y - 1 = 0 &\text{ or } &y - 3 = 0 \\
 y = 1 &\text{ or } &y = 3
 \end{aligned}$$

Both of these answers are easily checked by substituting them into the original equation.

An alternative method to solving this equation is to begin by dividing both sides by $(y - 1)$ to simplify things outright. As we saw in Example 0.3.1, however, whenever we divide by a

¹³More generally, given a positive power p , the only solution to $X^p = 0$ is $X = 0$.

variable quantity, we make the explicit assumption that this quantity is nonzero. Thus we must stipulate that $y - 1 \neq 0$.

$$\begin{aligned} \frac{(y-1)^2}{(y-1)} &= \frac{2(y-1)}{(y-1)} && \text{Divide by } (y-1) - \text{this assumes } (y-1) \neq 0 \\ y-1 &= 2 \\ y &= 3 \end{aligned}$$

Note that in this approach, we obtain the $y = 3$ solution, but we ‘lose’ the $y = 1$ solution. How did that happen? Assuming $y - 1 \neq 0$ is equivalent to assuming $y \neq 1$. This is an issue because $y = 1$ is a solution to the original equation and it was ‘divided out’ too early. The moral of the story? If you decide to divide by a variable expression, double check that you aren’t excluding any solutions.¹⁴

4. Proceeding as before, we clear fractions, gather the nonzero terms on one side of the equation, have 0 on the other and factor.

$$\begin{aligned} \frac{w^4}{3} &= \frac{8w^3 - 12}{12} - \frac{w^2 - 4}{4} \\ 12\left(\frac{w^4}{3}\right) &= 12\left(\frac{8w^3 - 12}{12} - \frac{w^2 - 4}{4}\right) && \text{Multiply by 12} \\ 4w^4 &= (8w^3 - 12) - 3(w^2 - 4) && \text{Distribute} \\ 4w^4 &= 8w^3 - 12 - 3w^2 + 12 && \text{Distribute} \\ 0 &= 8w^3 - 12 - 3w^2 + 12 - 4w^4 && \text{Subtract } 4w^4 \\ 0 &= 8w^3 - 3w^2 - 4w^4 && \text{Gather like terms} \\ 0 &= w^2(8w - 3 - 4w^2) && \text{Factor out G.C.F.} \end{aligned}$$

At this point, we apply the Zero Product Property to deduce that $w^2 = 0$ or $8w - 3 - 4w^2 = 0$. From $w^2 = 0$, we get $w = 0$. To solve $8w - 3 - 4w^2 = 0$, we rearrange terms and factor: $-4w^2 + 8w - 3 = (2w - 1)(-2w + 3) = 0$. Applying the Zero Product Property again, we get $2w - 1 = 0$ (which gives $w = \frac{1}{2}$), or $-2w + 3 = 0$ (which gives $w = \frac{3}{2}$). Our final answers are $w = 0$, $w = \frac{1}{2}$ and $w = \frac{3}{2}$. The reader is encouraged to check each of these answers in the original equation. (You need the practice with fractions!)

5. For our next example, we begin by subtracting the 25 from both sides then work out the indicated operations before factoring by grouping.

$$\begin{aligned} z(z(18z + 9) - 50) &= 25 \\ z(z(18z + 9) - 50) - 25 &= 0 && \text{Subtract 25} \\ z(18z^2 + 9z - 50) - 25 &= 0 && \text{Distribute} \\ 18z^3 + 9z^2 - 50z - 25 &= 0 && \text{Distribute} \\ 9z^2(2z + 1) - 25(2z + 1) &= 0 && \text{Factor} \\ (9z^2 - 25)(2z + 1) &= 0 && \text{Factor} \end{aligned}$$

¹⁴You will see other examples throughout this text where dividing by a variable quantity does more harm than good. Keep this basic one in mind as you move on in your studies - it’s a good cautionary tale.

At this point, we use the Zero Product Property and get $9z^2 - 25 = 0$ or $2z + 1 = 0$. The latter gives $z = -\frac{1}{2}$ whereas the former factors as $(3z - 5)(3z + 5) = 0$. Applying the Zero Product Property again gives $3z - 5 = 0$ (so $z = \frac{5}{3}$) or $3z + 5 = 0$ (so $z = -\frac{5}{3}$.) Our final answers are $z = -\frac{1}{2}$, $z = \frac{5}{3}$ and $z = -\frac{5}{3}$, each of which good fun to check.

6. The nonzero terms of the equation $x^4 - 8x^2 - 9 = 0$ are already on one side of the equation so we proceed to factor. This trinomial doesn't fit the pattern of a perfect square so we attempt to reverse the F.O.I.L.ing process. With an x^4 term, we have two possible forms to try: $(ax^2 + b)(cx^2 + d)$ and $(ax^3 + b)(cx + d)$. We leave it to you to show that $(ax^3 + b)(cx + d)$ does not work and we show that $(ax^2 + b)(cx^2 + d)$ does.

Since the coefficient of x^4 is 1, we take $a = c = 1$. The constant term is -9 so we know b and d have opposite signs and our choices are limited to two options: either b and d come from ± 1 and ± 9 OR one is 3 while the other is -3 . After some trial and error, we get $x^4 - 8x^2 - 9 = (x^2 - 9)(x^2 + 1)$. Hence $x^4 - 8x^2 - 9 = 0$ reduces to $(x^2 - 9)(x^2 + 1) = 0$. The Zero Product Property tells us that either $x^2 - 9 = 0$ or $x^2 + 1 = 0$. To solve the former, we factor: $(x - 3)(x + 3) = 0$, so $x - 3 = 0$ (hence, $x = 3$) or $x + 3 = 0$ (hence, $x = -3$). The equation $x^2 + 1 = 0$ has no (real) solution, since for any real number x , x^2 is always 0 or greater. Thus $x^2 + 1$ is always positive. Our final answers are $x = 3$ and $x = -3$. As always, the reader is invited to check both answers in the original equation. \square

0.6.2 EXERCISES

In Exercises 1 - 30, factor completely over the integers. Check your answer by multiplication.

- | | | |
|----------------------------|----------------------------|--------------------------------------|
| 1. $2x - 10x^2$ | 2. $12t^5 - 8t^3$ | 3. $16xy^2 - 12x^2y$ |
| 4. $5(m+3)^2 - 4(m+3)^3$ | 5. $(2x-1)(x+3) - 4(2x-1)$ | 6. $t^2(t-5) + t - 5$ |
| 7. $w^2 - 121$ | 8. $49 - 4t^2$ | 9. $81t^4 - 16$ |
| 10. $9z^2 - 64y^4$ | 11. $(y+3)^2 - 4y^2$ | 12. $(x+h)^3 - (x+h)$ |
| 13. $y^2 - 24y + 144$ | 14. $25t^2 + 10t + 1$ | 15. $12x^3 - 36x^2 + 27x$ |
| 16. $m^4 + 10m^2 + 25$ | 17. $27 - 8x^3$ | 18. $t^6 + t^3$ |
| 19. $x^2 - 5x - 14$ | 20. $y^2 - 12y + 27$ | 21. $3t^2 + 16t + 5$ |
| 22. $6x^2 - 23x + 20$ | 23. $35 + 2m - m^2$ | 24. $7w - 2w^2 - 3$ |
| 25. $3m^3 + 9m^2 - 12m$ | 26. $x^4 + x^2 - 20$ | 27. $4(t^2 - 1)^2 + 3(t^2 - 1) - 10$ |
| 28. $x^3 - 5x^2 - 9x + 45$ | 29. $3t^2 + t - 3 - t^3$ | 30. ¹⁵ $y^4 + 5y^2 + 9$ |

In Exercises 31 - 45, find all rational number solutions. Check your answers.

- | | | |
|-------------------------------|---|--|
| 31. $(7x+3)(x-5) = 0$ | 32. $(2t-1)^2(t+4) = 0$ | 33. $(y^2+4)(3y^2+y-10) = 0$ |
| 34. $4t = t^2$ | 35. $y+3 = 2y^2$ | 36. $26x = 8x^2 + 21$ |
| 37. $16x^4 = 9x^2$ | 38. $w(6w+11) = 10$ | 39. $2w^2+5w+2 = -3(2w+1)$ |
| 40. $x^2(x-3) = 16(x-3)$ | 41. $(2t+1)^3 = (2t+1)$ | 42. $a^4 + 4 = 6 - a^2$ |
| 43. $\frac{8t^2}{3} = 2t + 3$ | 44. $\frac{x^3+x}{2} = \frac{x^2+1}{3}$ | 45. $\frac{y^4}{3} - y^2 = \frac{3}{2}(y^2+3)$ |
46. With help from your classmates, factor $4x^4 + 8x^2 + 9$.
47. With help from your classmates, find an equation which has 3, $-\frac{1}{2}$, and 117 as solutions.

¹⁵ $y^4 + 5y^2 + 9 = (y^4 + 6y^2 + 9) - y^2$

0.6.3 ANSWERS

1. $2x(1 - 5x)$
2. $4t^3(3t^2 - 2)$
3. $4xy(4y - 3x)$
4. $-(m + 3)^2(4m + 7)$
5. $(2x - 1)(x - 1)$
6. $(t - 5)(t^2 + 1)$
7. $(w - 11)(w + 11)$
8. $(7 - 2t)(7 + 2t)$
9. $(3t - 2)(3t + 2)(9t^2 + 4)$
10. $(3z - 8y^2)(3z + 8y^2)$
11. $-3(y - 3)(y + 1)$
12. $(x + h)(x + h - 1)(x + h + 1)$
13. $(y - 12)^2$
14. $(5t + 1)^2$
15. $3x(2x - 3)^2$
16. $(m^2 + 5)^2$
17. $(3 - 2x)(9 + 6x + 4x^2)$
18. $t^3(t + 1)(t^2 - t + 1)$
19. $(x - 7)(x + 2)$
20. $(y - 9)(y - 3)$
21. $(3t + 1)(t + 5)$
22. $(2x - 5)(3x - 4)$
23. $(7 - m)(5 + m)$
24. $(-2w + 1)(w - 3)$
25. $3m(m - 1)(m + 4)$
26. $(x - 2)(x + 2)(x^2 + 5)$
27. $(2t - 3)(2t + 3)(t^2 + 1)$
28. $(x - 3)(x + 3)(x - 5)$
29. $(t - 3)(1 - t)(1 + t)$
30. $(y^2 - y + 3)(y^2 + y + 3)$
31. $x = -\frac{3}{7}$ or $x = 5$
32. $t = \frac{1}{2}$ or $t = -4$
33. $y = \frac{5}{3}$ or $y = -2$
34. $t = 0$ or $t = 4$
35. $y = -1$ or $y = \frac{3}{2}$
36. $x = \frac{3}{2}$ or $x = \frac{7}{4}$
37. $x = 0$ or $x = \pm\frac{3}{4}$
38. $w = -\frac{5}{2}$ or $w = \frac{2}{3}$
39. $w = -5$ or $w = -\frac{1}{2}$
40. $x = 3$ or $x = \pm 4$
41. $t = -1$, $t = -\frac{1}{2}$, or $t = 0$
42. $a = \pm 1$
43. $t = -\frac{3}{4}$ or $t = \frac{3}{2}$
44. $x = \frac{2}{3}$
45. $y = \pm 3$

0.7 QUADRATIC EQUATIONS

In Section 0.6.1, we reviewed how to solve basic non-linear equations by factoring. The astute reader should have noticed that all of the equations in that section were carefully constructed so that the polynomials could be factored using the integers. To demonstrate just how contrived the equations had to be, we can solve $2x^2 + 5x - 3 = 0$ by factoring, $(2x - 1)(x + 3) = 0$, from which we obtain $x = \frac{1}{2}$ and $x = -3$. If we change the 5 to a 6 and try to solve $2x^2 + 6x - 3 = 0$, however, we find that this polynomial doesn't factor over the integers and we are stuck. It turns out that there are two real number solutions to this equation, but they are *irrational* numbers, and our aim in this section is to review the techniques which allow us to find these solutions.¹ In this section, we focus our attention on **quadratic** equations.

Definition 0.15. An equation is said to be **quadratic** in a variable X if it can be written in the form $AX^2 + BX + C = 0$ where A , B and C are expressions which do not involve X and $A \neq 0$.

Think of quadratic equations as equations that are one degree up from linear equations - instead of the highest power of X being just $X = X^1$, it's X^2 . The simplest class of quadratic equations to solve are the ones in which $B = 0$. In that case, we have the following.

Solving Quadratic Equations by Extracting Square Roots

If c is a real number with $c \geq 0$, the solutions to $X^2 = c$ are $X = \pm\sqrt{c}$.

Note: If $c < 0$, $X^2 = c$ has no real number solutions.

There are a couple different ways to see why Extracting Square Roots works, both of which are demonstrated by solving the equation $x^2 = 3$. If we follow the procedure outlined in the previous section, we subtract 3 from both sides to get $x^2 - 3 = 0$ and we now try to factor $x^2 - 3$. As mentioned in the remarks following Definition 0.14, we could think of $x^2 - 3 = x^2 - (\sqrt{3})^2$ and apply the Difference of Squares formula to factor $x^2 - 3 = (x - \sqrt{3})(x + \sqrt{3})$. We solve $(x - \sqrt{3})(x + \sqrt{3}) = 0$ by using the Zero Product Property as before by setting each factor equal to zero: $x - \sqrt{3} = 0$ and $x + \sqrt{3} = 0$. We get the answers $x = \pm\sqrt{3}$. In general, if $c \geq 0$, then \sqrt{c} is a real number, so $x^2 - c = x^2 - (\sqrt{c})^2 = (x - \sqrt{c})(x + \sqrt{c})$. Replacing the '3' with 'c' in the above discussion gives the general result.

Another way to view this result is to visualize 'taking the square root' of both sides: since $x^2 = c$, $\sqrt{x^2} = \sqrt{c}$. How do we simplify $\sqrt{x^2}$? We have to exercise a bit of caution here. Note that $\sqrt{(5)^2}$ and $\sqrt{(-5)^2}$ both simplify to $\sqrt{25} = 5$. In both cases, $\sqrt{x^2}$ returned a *positive* number, since the negative in -5 was 'squared away' *before* we took the square root. In other words, $\sqrt{x^2}$ is x if x is positive, or, if x is negative, we make x positive - that is, $\sqrt{x^2} = |x|$, the absolute value of x . So from $x^2 = 3$, we 'take the square root' of both sides of the equation to get $\sqrt{x^2} = \sqrt{3}$. This simplifies to $|x| = \sqrt{3}$, which by Theorem 0.3 is equivalent to $x = \sqrt{3}$ or $x = -\sqrt{3}$. Replacing the '3' in the previous argument with 'c,' gives the general result.

¹While our discussion in this section departs from factoring, we'll see in Chapter 3 that the same correspondence between factoring and solving equations holds whether or not the polynomial factors over the integers.

As you might expect, Extracting Square Roots can be applied to more complicated equations. Consider the equation below. We can solve it by Extracting Square Roots provided we first isolate the perfect square quantity:

$$\begin{aligned}
 2\left(x + \frac{3}{2}\right)^2 - \frac{15}{2} &= 0 \\
 2\left(x + \frac{3}{2}\right)^2 &= \frac{15}{2} && \text{Add } \frac{15}{2} \\
 \left(x + \frac{3}{2}\right)^2 &= \frac{15}{4} && \text{Divide by 2} \\
 x + \frac{3}{2} &= \pm\sqrt{\frac{15}{4}} && \text{Extract Square Roots} \\
 x + \frac{3}{2} &= \pm\frac{\sqrt{15}}{2} && \text{Property of Radicals} \\
 x &= -\frac{3}{2} \pm \frac{\sqrt{15}}{2} && \text{Subtract } \frac{3}{2} \\
 x &= -\frac{3 \pm \sqrt{15}}{2} && \text{Add fractions}
 \end{aligned}$$

Let's return to the equation $2x^2 + 6x - 3 = 0$ from the beginning of the section. We leave it to the reader to show that

$$2\left(x + \frac{3}{2}\right)^2 - \frac{15}{2} = 2x^2 + 6x - 3.$$

(Hint: Expand the left side.) In other words, we can solve $2x^2 + 6x - 3 = 0$ by *transforming* into an equivalent equation. This process, you may recall, is called 'Completing the Square.' We'll revisit Completing the Square in Section 2.3 in more generality and for a different purpose but for now we revisit the steps needed to complete the square to solve a quadratic equation.

Solving Quadratic Equations: Completing the Square

To solve a quadratic equation $AX^2 + BX + C = 0$ by Completing the Square:

1. Subtract the constant C from both sides.
2. Divide both sides by A , the coefficient of X^2 . (Remember: $A \neq 0$.)
3. Add $\left(\frac{B}{2A}\right)^2$ to both sides of the equation. (That's half the coefficient of X , squared.)
4. Factor the left hand side of the equation as $\left(X + \frac{B}{2A}\right)^2$.
5. Extract Square Roots.
6. Subtract $\frac{B}{2A}$ from both sides.

To refresh our memories, we apply this method to solve $3x^2 - 24x + 5 = 0$:

$$\begin{array}{rcl}
 3x^2 - 24x + 5 & = & 0 \\
 3x^2 - 24x & = & -5 \qquad \text{Subtract } C = 5 \\
 x^2 - 8x & = & -\frac{5}{3} \qquad \text{Divide by } A = 3 \\
 x^2 - 8x + 16 & = & -\frac{5}{3} + 16 \qquad \text{Add } \left(\frac{B}{2A}\right)^2 = (-4)^2 = 16 \\
 (x - 4)^2 & = & \frac{43}{3} \qquad \text{Factor: Perfect Square Trinomial} \\
 x - 4 & = & \pm\sqrt{\frac{43}{3}} \qquad \text{Extract Square Roots} \\
 x & = & 4 \pm \sqrt{\frac{43}{3}} \qquad \text{Add 4}
 \end{array}$$

At this point, we use properties of fractions and radicals to ‘rationalize’ the denominator:²

$$\sqrt{\frac{43}{3}} = \sqrt{\frac{43 \cdot 3}{3 \cdot 3}} = \frac{\sqrt{129}}{\sqrt{9}} = \frac{\sqrt{129}}{3}$$

We can now get a common (integer) denominator which yields:

$$x = 4 \pm \sqrt{\frac{43}{3}} = 4 \pm \frac{\sqrt{129}}{3} = \frac{12 \pm \sqrt{129}}{3}$$

The key to Completing the Square is that the procedure always produces a perfect square trinomial. To see why this works *every single time*, we start with $AX^2 + BX + C = 0$ and follow the procedure:

$$\begin{array}{rcl}
 AX^2 + BX + C & = & 0 \\
 AX^2 + BX & = & -C \qquad \text{Subtract } C \\
 X^2 + \frac{BX}{A} & = & -\frac{C}{A} \qquad \text{Divide by } A \neq 0 \\
 X^2 + \frac{BX}{A} + \left(\frac{B}{2A}\right)^2 & = & -\frac{C}{A} + \left(\frac{B}{2A}\right)^2 \qquad \text{Add } \left(\frac{B}{2A}\right)^2
 \end{array}$$

(Hold onto the line above for a moment.) Here’s the heart of the method - we need to show that

$$X^2 + \frac{BX}{A} + \left(\frac{B}{2A}\right)^2 = \left(X + \frac{B}{2A}\right)^2$$

To show this, we start with the right side of the equation and apply the Perfect Square Formula from Theorem 0.7

$$\left(X + \frac{B}{2A}\right)^2 = X^2 + 2\left(\frac{B}{2A}\right)X + \left(\frac{B}{2A}\right)^2 = X^2 + \frac{BX}{A} + \left(\frac{B}{2A}\right)^2 \checkmark$$

²Recall that this means we want to get a denominator with rational (more specifically, integer) numbers.

With just a few more steps we can solve the general equation $AX^2 + BX + C = 0$ so let's pick up the story where we left off. (The line on the previous page we told you to hold on to.)

$$\begin{aligned}
 X^2 + \frac{BX}{A} + \left(\frac{B}{2A}\right)^2 &= -\frac{C}{A} + \left(\frac{B}{2A}\right)^2 \\
 \left(X + \frac{B}{2A}\right)^2 &= -\frac{C}{A} + \frac{B^2}{4A^2} && \text{Factor: Perfect Square Trinomial} \\
 \left(X + \frac{B}{2A}\right)^2 &= -\frac{4AC}{4A^2} + \frac{B^2}{4A^2} && \text{Get a common denominator} \\
 \left(X + \frac{B}{2A}\right)^2 &= \frac{B^2 - 4AC}{4A^2} && \text{Add fractions} \\
 X + \frac{B}{2A} &= \pm\sqrt{\frac{B^2 - 4AC}{4A^2}} && \text{Extract Square Roots} \\
 X + \frac{B}{2A} &= \pm\frac{\sqrt{B^2 - 4AC}}{2A} && \text{Properties of Radicals} \\
 X &= -\frac{B}{2A} \pm \frac{\sqrt{B^2 - 4AC}}{2A} && \text{Subtract } \frac{B}{2A} \\
 X &= \frac{-B \pm \sqrt{B^2 - 4AC}}{2A} && \text{Add fractions.}
 \end{aligned}$$

Lo and behold, we have derived the legendary **Quadratic Formula!**

Theorem 0.9. Quadratic Formula: The solution to $AX^2 + BX + C = 0$ with $A \neq 0$ is:

$$X = \frac{-B \pm \sqrt{B^2 - 4AC}}{2A}$$

We can check our earlier solutions to $2x^2 + 6x - 3 = 0$ and $3x^2 - 24x + 5 = 0$ using the Quadratic Formula. For $2x^2 + 6x - 3 = 0$, we identify $A = 2$, $B = 6$ and $C = -3$. The quadratic formula gives:

$$x = \frac{-6 \pm \sqrt{6^2 - 4(2)(-3)}}{2(2)} = \frac{-6 \pm \sqrt{36 + 24}}{4} = \frac{-6 \pm \sqrt{60}}{4}$$

Using properties of radicals ($\sqrt{60} = 2\sqrt{15}$), this reduces to $\frac{2(-3 \pm \sqrt{15})}{4} = \frac{-3 \pm \sqrt{15}}{2}$. We leave it to the reader to show these two answers are the same as $-\frac{3 \pm \sqrt{15}}{2}$, as required.³

For $3x^2 - 24x + 5 = 0$, we identify $A = 3$, $B = -24$ and $C = 5$. Here, we get:

$$x = \frac{-(-24) \pm \sqrt{(-24)^2 - 4(3)(5)}}{2(3)} = \frac{24 \pm \sqrt{516}}{6}$$

Since $\sqrt{516} = 2\sqrt{129}$, this reduces to $x = \frac{12 \pm \sqrt{129}}{3}$.

³Think about what $-(3 \pm \sqrt{15})$ is really telling you.

It is worth noting that the Quadratic Formula applies to all quadratic equations - even ones we could solve using other techniques. For example, to solve $2x^2 + 5x - 3 = 0$ we identify $A = 2$, $B = 5$ and $C = -3$. This yields:

$$x = \frac{-5 \pm \sqrt{5^2 - 4(2)(-3)}}{2(2)} = \frac{-5 \pm \sqrt{49}}{4} = \frac{-5 \pm 7}{4}$$

At this point, we have $x = \frac{-5+7}{4} = \frac{1}{2}$ and $x = \frac{-5-7}{4} = \frac{-12}{4} = -3$ - the same two answers we obtained factoring. We can also use it to solve $x^2 = 3$, if we wanted to. From $x^2 - 3 = 0$, we have $A = 1$, $B = 0$ and $C = -3$. The Quadratic Formula produces

$$x = \frac{-0 \pm \sqrt{0^2 - 4(1)(-3)}}{2(1)} = \frac{\pm\sqrt{12}}{2} = \pm\frac{2\sqrt{3}}{2} = \pm\sqrt{3}$$

As this last example illustrates, while the Quadratic Formula *can* be used to solve every quadratic equation, that doesn't mean it *should* be used. Many times other methods are more efficient. We now provide a more comprehensive approach to solving Quadratic Equations.

Strategies for Solving Quadratic Equations

- If the variable appears in the squared term only, isolate it and Extract Square Roots.
- Otherwise, put the nonzero terms on one side of the equation so that the other side is 0.
 - Try factoring.
 - If the expression doesn't factor easily, use the Quadratic Formula.

The reader is encouraged to pause for a moment to think about why 'Completing the Square' doesn't appear in our list of strategies despite the fact that we've spent the majority of the section so far talking about it.⁴ Let's get some practice solving quadratic equations, shall we?

Example 0.7.1. Find all real number solutions to the following equations.

1. $3 - (2w - 1)^2 = 0$
2. $5x - x(x - 3) = 7$
3. $(y - 1)^2 = 2 - \frac{y + 2}{3}$
4. $5(25 - 21x) = \frac{59}{4} - 25x^2$
5. $-4.9t^2 + 10t\sqrt{3} + 2 = 0$
6. $2x^2 = 3x^4 - 6$

Solution.

1. Since $3 - (2w - 1)^2 = 0$ contains a perfect square, we isolate it first then extract square roots:

$$\begin{aligned} 3 - (2w - 1)^2 &= 0 \\ 3 &= (2w - 1)^2 && \text{Add } (2w - 1)^2 \\ \pm\sqrt{3} &= 2w - 1 && \text{Extract Square Roots} \\ 1 \pm \sqrt{3} &= 2w && \text{Add 1} \\ \frac{1 \pm \sqrt{3}}{2} &= w && \text{Divide by 2} \end{aligned}$$

⁴Unacceptable answers include "Jeff and Carl are mean" and "It was one of Carl's Pedantic Rants".

We find our two answers $w = \frac{1 \pm \sqrt{3}}{2}$. The reader is encouraged to check both answers by substituting each into the original equation.⁵

2. To solve $5x - x(x - 3) = 7$, we begin performing the indicated operations and getting one side equal to 0.

$$\begin{aligned} 5x - x(x - 3) &= 7 \\ 5x - x^2 + 3x &= 7 && \text{Distribute} \\ -x^2 + 8x &= 7 && \text{Gather like terms} \\ -x^2 + 8x - 7 &= 0 && \text{Subtract 7} \end{aligned}$$

At this point, we attempt to factor and find $-x^2 + 8x - 7 = (x - 1)(-x + 7)$. Using the Zero Product Property, we get $x - 1 = 0$ or $-x + 7 = 0$. Our answers are $x = 1$ or $x = 7$, both of which are easy to check.

3. Even though we have a perfect square in $(y - 1)^2 = 2 - \frac{y+2}{3}$, Extracting Square Roots won't help matters since we have a y on the other side of the equation. Our strategy here is to perform the indicated operations (and clear the fraction for good measure) and get 0 on one side of the equation.

$$\begin{aligned} (y - 1)^2 &= 2 - \frac{y + 2}{3} \\ y^2 - 2y + 1 &= 2 - \frac{y + 2}{3} && \text{Perfect Square Trinomial} \\ 3(y^2 - 2y + 1) &= 3 \left(2 - \frac{y + 2}{3} \right) && \text{Multiply by 3} \\ 3y^2 - 6y + 3 &= 6 - 3 \left(\frac{y + 2}{3} \right) && \text{Distribute} \\ 3y^2 - 6y + 3 &= 6 - (y + 2) \\ 3y^2 - 6y + 3 - 6 + (y + 2) &= 0 && \text{Subtract 6, Add } (y + 2) \\ 3y^2 - 5y - 1 &= 0 \end{aligned}$$

A cursory attempt at factoring bears no fruit, so we run this through the Quadratic Formula with $A = 3$, $B = -5$ and $C = -1$.

$$\begin{aligned} y &= \frac{-(-5) \pm \sqrt{(-5)^2 - 4(3)(-1)}}{2(3)} \\ y &= \frac{5 \pm \sqrt{25 + 12}}{6} \\ y &= \frac{5 \pm \sqrt{37}}{6} \end{aligned}$$

Since 37 is prime, we have no way to reduce $\sqrt{37}$. Thus, our final answers are $y = \frac{5 \pm \sqrt{37}}{6}$. The reader is encouraged to supply the details of the challenging verification of the answers.

⁵It's excellent practice working with radicals fractions so we really, *really* want you to take the time to do it.

4. We proceed as before; our aim is to gather the nonzero terms on one side of the equation.

$$\begin{aligned}
 5(25 - 21x) &= \frac{59}{4} - 25x^2 \\
 125 - 105x &= \frac{59}{4} - 25x^2 && \text{Distribute} \\
 4(125 - 105x) &= 4\left(\frac{59}{4} - 25x^2\right) && \text{Multiply by 4} \\
 500 - 420x &= 59 - 100x^2 && \text{Distribute} \\
 500 - 420x - 59 + 100x^2 &= 0 && \text{Subtract 59, Add } 100x^2 \\
 100x^2 - 420x + 441 &= 0 && \text{Gather like terms}
 \end{aligned}$$

With highly composite numbers like 100 and 441, factoring seems inefficient at best,⁶ so we apply the Quadratic Formula with $A = 100$, $B = -420$ and $C = 441$:

$$\begin{aligned}
 x &= \frac{-(-420) \pm \sqrt{(-420)^2 - 4(100)(441)}}{2(100)} \\
 &= \frac{420 \pm \sqrt{176000 - 176400}}{200} \\
 &= \frac{420 \pm \sqrt{0}}{200} \\
 &= \frac{420 \pm 0}{200} \\
 &= \frac{420}{200} \\
 &= \frac{21}{10}
 \end{aligned}$$

To our surprise and delight we obtain just one answer, $x = \frac{21}{10}$.

5. Our next equation $-4.9t^2 + 10t\sqrt{3} + 2 = 0$, already has 0 on one side of the equation, but with coefficients like -4.9 and $10\sqrt{3}$, factoring with integers is not an option. We could make things a *bit* easier on the eyes by clearing the decimal (by multiplying through by 10) to get $-49t^2 + 100t\sqrt{3} + 20 = 0$ but we simply cannot rid ourselves of the irrational number $\sqrt{3}$. The Quadratic Formula is our only recourse. With $A = -49$, $B = 100\sqrt{3}$ and $C = 20$ we get:

⁶This is actually the Perfect Square Trinomial $(10x - 21)^2$.

$$\begin{aligned}
t &= \frac{-100\sqrt{3} \pm \sqrt{(100\sqrt{3})^2 - 4(-49)(20)}}{2(-49)} \\
&= \frac{-100\sqrt{3} \pm \sqrt{30000 + 3920}}{-98} \\
&= \frac{-100\sqrt{3} \pm \sqrt{33920}}{-98} \\
&= \frac{-100\sqrt{3} \pm 8\sqrt{530}}{-98} \\
&= \frac{2(-50\sqrt{3} \pm 4\sqrt{530})}{2(-49)} \\
&= \frac{-50\sqrt{3} \pm 4\sqrt{530}}{-49} && \text{Reduce} \\
&= \frac{-(-50\sqrt{3} \pm 4\sqrt{530})}{49} && \text{Properties of Negatives} \\
&= \frac{50\sqrt{3} \mp 4\sqrt{530}}{49} && \text{Distribute}
\end{aligned}$$

You'll note that when we 'distributed' the negative in the last step, we changed the ' \pm ' to a ' \mp .' While this is technically correct, at the end of the day both symbols mean 'plus or minus',⁷ so we can write our answers as $t = \frac{50\sqrt{3} \pm 4\sqrt{530}}{49}$. Checking these answers are a true test of arithmetic mettle.

6. At first glance, the equation $2x^2 = 3x^4 - 6$ seems misplaced. The highest power of the variable x here is 4, not 2, so this equation isn't a quadratic equation - at least not in terms of the variable x . It is, however, an example of an equation that is quadratic 'in disguise.'⁸ We introduce a new variable u to help us see the pattern - specifically we let $u = x^2$. Thus $u^2 = (x^2)^2 = x^4$. So in terms of the variable u , the equation $2x^2 = 3x^4 - 6$ is $2u = 3u^2 - 6$. The latter is a quadratic equation, which we can solve using the usual techniques:

$$\begin{aligned}
2u &= 3u^2 - 6 \\
0 &= 3u^2 - 2u - 6 && \text{Subtract } 2u
\end{aligned}$$

After a few attempts at factoring, we resort to the Quadratic Formula with $A = 3$, $B = -2$,

⁷There are instances where we need both symbols, however. For example, the Sum and Difference of Cubes Formulas (page 72) can be written as a single formula: $a^3 \pm b^3 = (a \pm b)(a^2 \mp ab + b^2)$. In this case, all of the 'top' symbols are read to give the sum formula; the 'bottom' symbols give the difference formula.

⁸More formally, **quadratic in form**. Carl likes 'Quadratics in Disguise' since it reminds him of the tagline of one of his beloved childhood cartoons and toy lines.

$C = -6$ and get:

$$\begin{aligned}
 u &= \frac{-(-2) \pm \sqrt{(-2)^2 - 4(3)(-6)}}{2(3)} \\
 &= \frac{2 \pm \sqrt{4 + 72}}{6} \\
 &= \frac{2 \pm \sqrt{76}}{6} \\
 &= \frac{2 \pm \sqrt{4 \cdot 19}}{6} \\
 &= \frac{2 \pm 2\sqrt{19}}{6} && \text{Properties of Radicals} \\
 &= \frac{2(1 \pm \sqrt{19})}{2(3)} && \text{Factor} \\
 &= \frac{1 \pm \sqrt{19}}{3} && \text{Reduce}
 \end{aligned}$$

We've solved the equation for u , but what we still need to solve the original equation⁹ - which means we need to find the corresponding values of x . Since $u = x^2$, we have two equations:

$$x^2 = \frac{1 + \sqrt{19}}{3} \quad \text{or} \quad x^2 = \frac{1 - \sqrt{19}}{3}$$

We can solve the first equation by extracting square roots to get $x = \pm\sqrt{\frac{1+\sqrt{19}}{3}}$. The second equation, however, has no real number solutions because $\frac{1-\sqrt{19}}{3}$ is a negative number. For our final answers we can rationalize the denominator¹⁰ to get:

$$x = \pm\sqrt{\frac{1 + \sqrt{19}}{3}} = \pm\sqrt{\frac{1 + \sqrt{19}}{3} \cdot \frac{3}{3}} = \pm\frac{\sqrt{3 + 3\sqrt{19}}}{3}$$

As with the previous exercise, the very challenging check is left to the reader. □

Our last example above, the 'Quadratic in Disguise', hints that the Quadratic Formula is applicable to a wider class of equations than those which are strictly quadratic. We give some general guidelines to recognizing these beasts in the wild on the next page.

⁹Or, you've solved the equation for 'you' (u), now you have to solve it for your instructor (x).

¹⁰We'll say more about this technique in Section 0.9.

Identifying Quadratics in Disguise

An equation is a ‘Quadratic in Disguise’ if it can be written in the form: $AX^{2m} + BX^m + C = 0$. In other words:

- There are exactly three terms, two with variables and one constant term.
- The exponent on the variable in one term is *exactly twice* the variable on the other term.

To transform a Quadratic in Disguise to a quadratic equation, let $u = X^m$ so $u^2 = (X^m)^2 = X^{2m}$. This transforms the equation into $Au^2 + Bu + C = 0$.

For example, $3x^6 - 2x^3 + 1 = 0$ is a Quadratic in Disguise, since $6 = 2 \cdot 3$. If we let $u = x^3$, we get $u^2 = (x^3)^2 = x^6$, so the equation becomes $3u^2 - 2u + 1 = 0$. However, $3x^6 - 2x^2 + 1 = 0$ is *not* a Quadratic in Disguise, since $6 \neq 2 \cdot 2$. The substitution $u = x^2$ yields $u^2 = (x^2)^2 = x^4$, not x^6 as required. We’ll see more instances of ‘Quadratics in Disguise’ in later sections.

We close this section with a review of the **discriminant** of a quadratic equation as defined below.

Definition 0.16. The Discriminant: Given a quadratic equation $AX^2 + BX + C = 0$, the quantity $B^2 - 4AC$ is called the **discriminant** of the equation.

The discriminant is the radicand of the square root in the quadratic formula:

$$X = \frac{-B \pm \sqrt{B^2 - 4AC}}{2A}$$

It *discriminates* between the nature and number of solutions we get from a quadratic equation. The results are summarized below.

Theorem 0.10. Discriminant Theorem: Given a Quadratic Equation $AX^2 + BX + C = 0$, let $D = B^2 - 4AC$ be the discriminant.

- If $D > 0$, there are two distinct real number solutions to the equation.
- If $D = 0$, there is one repeated real number solution.

Note: ‘Repeated’ here comes from the fact that ‘both’ solutions $\frac{-B \pm 0}{2A}$ reduce to $-\frac{B}{2A}$.

- If $D < 0$, there are no real solutions.

For example, $x^2 + x - 1 = 0$ has two real number solutions since the discriminant works out to be $(1)^2 - 4(1)(-1) = 5 > 0$. This results in a $\pm\sqrt{5}$ in the Quadratic Formula, generating two different answers. On the other hand, $x^2 + x + 1 = 0$ has no real solutions since here, the discriminant is $(1)^2 - 4(1)(1) = -3 < 0$ which generates a $\pm\sqrt{-3}$ in the Quadratic Formula. The equation $x^2 + 2x + 1 = 0$ has discriminant $(2)^2 - 4(1)(1) = 0$ so in the Quadratic Formula we get a $\pm\sqrt{0} = 0$ thereby generating just one solution. More can be said as well. For example, the discriminant of $6x^2 - x - 40 = 0$ is 961. This is a perfect square, $\sqrt{961} = 31$, which means our solutions are

rational numbers. When our solutions are rational numbers, the quadratic actually factors nicely. In our example $6x^2 - x - 40 = (2x + 5)(3x - 8)$. Admittedly, if you've already computed the discriminant, you're most of the way done with the problem and probably wouldn't take the time to experiment with factoring the quadratic at this point – but we'll see another use for this analysis of the discriminant in the next section.¹¹

¹¹Specifically in Example 0.8.1.

0.7.1 EXERCISES

In Exercises 1 - 21, find all real solutions. Check your answers, as directed by your instructor.

1. $3\left(x - \frac{1}{2}\right)^2 = \frac{5}{12}$

2. $4 - (5t + 3)^2 = 3$

3. $3(y^2 - 3)^2 - 2 = 10$

4. $x^2 + x - 1 = 0$

5. $3w^2 = 2 - w$

6. $y(y + 4) = 1$

7. $\frac{z}{2} = 4z^2 - 1$

8. $0.1v^2 + 0.2v = 0.3$

9. $x^2 = x - 1$

10. $3 - t = 2(t + 1)^2$

11. $(x - 3)^2 = x^2 + 9$

12. $(3y - 1)(2y + 1) = 5y$

13. $w^4 + 3w^2 - 1 = 0$

14. $2x^4 + x^2 = 3$

15. $(2 - y)^4 = 3(2 - y)^2 + 1$

16. $3x^4 + 6x^2 = 15x^3$

17. $6p + 2 = p^2 + 3p^3$

18. $10v = 7v^3 - v^5$

19. $y^2 - \sqrt{8}y = \sqrt{18}y - 1$

20. $x^2\sqrt{3} = x\sqrt{6} + \sqrt{12}$

21. $\frac{v^2}{3} = \frac{v\sqrt{3}}{2} + 1$

In Exercises 22 - 27, find all real solutions and use a calculator to approximate your answers, rounded to two decimal places.

22. $5.54^2 + b^2 = 36$

23. $\pi r^2 = 37$

24. $54 = 8r\sqrt{2} + \pi r^2$

25. $-4.9t^2 + 100t = 410$

26. $x^2 = 1.65(3 - x)^2$

27. $(0.5 + 2A)^2 = 0.7(0.1 - A)^2$

In Exercises 28 - 30, use Theorem 0.3 along with the techniques in this section to find all real solutions to the following.

28. $|x^2 - 3x| = 2$

29. $|2x - x^2| = |2x - 1|$

30. $|x^2 - x + 3| = |4 - x^2|$

31. Prove that for every nonzero number p , $x^2 + xp + p^2 = 0$ has no real solutions.

32. Solve for t : $-\frac{1}{2}gt^2 + vt + h = 0$. Assume $g > 0$, $v \geq 0$ and $h \geq 0$.

0.7.2 ANSWERS

1. $x = \frac{3 \pm \sqrt{5}}{6}$

2. $t = -\frac{4}{5}, -\frac{2}{5}$

3. $y = \pm 1, \pm\sqrt{5}$

4. $x = \frac{-1 \pm \sqrt{5}}{2}$

5. $w = -1, \frac{2}{3}$

6. $y = -2 \pm \sqrt{5}$

7. $z = \frac{1 \pm \sqrt{65}}{16}$

8. $v = -3, 1$

9. No real solution.

10. $t = \frac{-5 \pm \sqrt{33}}{4}$

11. $x = 0$

12. $y = \frac{2 \pm \sqrt{10}}{6}$

13. $w = \pm \sqrt{\frac{\sqrt{13} - 3}{2}}$

14. $x = \pm 1$

15. $y = \frac{4 \pm \sqrt{6 + 2\sqrt{13}}}{2}$

16. $x = 0, \frac{5 \pm \sqrt{17}}{2}$

17. $p = -\frac{1}{3}, \pm\sqrt{2}$

18. $v = 0, \pm\sqrt{2}, \pm\sqrt{5}$

19. $y = \frac{5\sqrt{2} \pm \sqrt{46}}{2}$

20. $x = \frac{\sqrt{2} \pm \sqrt{10}}{2}$

21. $v = -\frac{\sqrt{3}}{2}, 2\sqrt{3}$

22. $b = \pm \frac{\sqrt{13271}}{50} \approx \pm 2.30$

23. $r = \pm \sqrt{\frac{37}{\pi}} \approx \pm 3.43$

24. $r = \frac{-4\sqrt{2} \pm \sqrt{54\pi + 32}}{\pi}, r \approx -6.32, 2.72$

25. $t = \frac{500 \pm 10\sqrt{491}}{49}, t \approx 5.68, 14.73$

26. $x = \frac{99 \pm 6\sqrt{165}}{13}, x \approx 1.69, 13.54$

27. $A = \frac{-107 \pm 7\sqrt{70}}{330}, A \approx -0.50, -0.15$

28. $x = 1, 2, \frac{3 \pm \sqrt{17}}{2}$

29. $x = \pm 1, 2 \pm \sqrt{3}$

30. $x = -\frac{1}{2}, 1, 7$

31. The discriminant is: $D = p^2 - 4p^2 = -3p^2 < 0$. Since $D < 0$, there are no real solutions.

32. $t = \frac{v \pm \sqrt{v^2 + 2gh}}{g}$

0.8 RATIONAL EXPRESSIONS AND EQUATIONS

We now turn our attention to rational expressions - that is, algebraic fractions - and equations which contain them. The reader is encouraged to keep in mind the properties of fractions listed on page 21 because we will need them along the way. Before we launch into reviewing the basic arithmetic operations of rational expressions, we take a moment to review how to simplify them properly. As with numeric fractions, we ‘cancel common *factors*,’ not common *terms*. That is, in order to simplify rational expressions, we first *factor* the numerator and denominator. For example:

$$\frac{x^4 + 5x^3}{x^3 - 25x} \neq \frac{x^4 + 5\cancel{x}}{\cancel{x} - 25x}$$

but, rather

$$\begin{aligned} \frac{x^4 + 5x^3}{x^3 - 25x} &= \frac{x^3(x + 5)}{x(x^2 - 25)} && \text{Factor G.C.F.} \\ &= \frac{x^3(x + 5)}{x(x - 5)(x + 5)} && \text{Difference of Squares} \\ &= \frac{\cancel{x^3}(x + 5)}{x(x - 5)\cancel{(x + 5)}} && \text{Cancel common factors} \\ &= \frac{x^2}{x - 5} \end{aligned}$$

This equivalence holds provided the factors being canceled aren’t 0. Since a factor of x and a factor of $x + 5$ were canceled, $x \neq 0$ and $x + 5 \neq 0$, so $x \neq -5$. We usually stipulate this as:

$$\frac{x^4 + 5x^3}{x^3 - 25x} = \frac{x^2}{x - 5}, \quad \text{provided } x \neq 0, x \neq -5$$

While we’re talking about common mistakes, please notice that

$$\frac{5}{x^2 + 9} \neq \frac{5}{x^2} + \frac{5}{9}$$

Just like their numeric counterparts, you don’t add algebraic fractions by *adding denominators* of fractions with *common numerators* - it’s the other way around:¹

$$\frac{x^2 + 9}{5} = \frac{x^2}{5} + \frac{9}{5}$$

It’s time to review the basic arithmetic operations with rational expressions.

¹One of the most common errors students make on college Mathematics placement tests is that they forget how to add algebraic fractions correctly. This places many students into remedial classes even though they are probably ready for college-level Math. We urge you to really study this section with great care so that you don’t fall into that trap.

Example 0.8.1. Perform the indicated operations and simplify.

$$1. \frac{2x^2 - 5x - 3}{x^4 - 4} \div \frac{x^2 - 2x - 3}{x^5 + 2x^3}$$

$$2. \frac{5}{w^2 - 9} - \frac{w + 2}{w^2 - 9}$$

$$3. \frac{3}{y^2 - 8y + 16} + \frac{y + 1}{16y - y^3}$$

$$4. \frac{\frac{2}{4 - (x + h)}}{h} - \frac{2}{4 - x}$$

$$5. 2t^{-3} - (3t)^{-2}$$

$$6. 10x(x - 3)^{-1} + 5x^2(-1)(x - 3)^{-2}$$

Solution.

1. As with numeric fractions, we divide rational expressions by ‘inverting and multiplying’. Before we get too carried away however, we factor to see what, if any, factors cancel.

$$\begin{aligned} \frac{2x^2 - 5x - 3}{x^4 - 4} \div \frac{x^2 - 2x - 3}{x^5 + 2x^3} &= \frac{2x^2 - 5x - 3}{x^4 - 4} \cdot \frac{x^5 + 2x^3}{x^2 - 2x - 3} && \text{Invert and multiply} \\ &= \frac{(2x^2 - 5x - 3)(x^5 + 2x^3)}{(x^4 - 4)(x^2 - 2x - 3)} && \text{Multiply fractions} \\ &= \frac{(2x + 1)(x - 3)x^3(x^2 + 2)}{(x^2 - 2)(x^2 + 2)(x - 3)(x + 1)} && \text{Factor} \\ &= \frac{(2x + 1)\cancel{(x - 3)}x^3\cancel{(x^2 + 2)}}{(x^2 - 2)\cancel{(x^2 + 2)}\cancel{(x - 3)}(x + 1)} && \text{Cancel common factors} \\ &= \frac{x^3(2x + 1)}{(x + 1)(x^2 - 2)} && \text{Provided } x \neq 3 \end{aligned}$$

The ‘ $x \neq 3$ ’ is mentioned since a factor of $(x - 3)$ was canceled as we reduced the expression. We also canceled a factor of $(x^2 + 2)$. Why is there no stipulation as a result of canceling this factor? Because $x^2 + 2 \neq 0$. (Can you see why?) At this point, we *could* go ahead and multiply out the numerator and denominator to get

$$\frac{x^3(2x + 1)}{(x + 1)(x^2 - 2)} = \frac{2x^4 + x^3}{x^3 + x^2 - 2x - 2}$$

but for most of the applications where this kind of algebra is needed (solving equations, for instance), it is best to leave things factored. Your instructor will let you know whether to leave your answer in factored form or not.²

²Speaking of factoring, do you remember why $x^2 - 2$ can’t be factored over the integers?

2. As with numeric fractions we need common denominators in order to subtract. This is the case here so we proceed by subtracting the numerators.

$$\begin{aligned} \frac{5}{w^2 - 9} - \frac{w + 2}{w^2 - 9} &= \frac{5 - (w + 2)}{w^2 - 9} && \text{Subtract fractions} \\ &= \frac{5 - w - 2}{w^2 - 9} && \text{Distribute} \\ &= \frac{3 - w}{w^2 - 9} && \text{Combine like terms} \end{aligned}$$

At this point, we need to see if we can reduce this expression so we proceed to factor. It first appears as if we have no common factors among the numerator and denominator until we recall the property of ‘factoring negatives’ from Page 20: $3 - w = -(w - 3)$. This yields:

$$\begin{aligned} \frac{3 - w}{w^2 - 9} &= \frac{-(w - 3)}{(w - 3)(w + 3)} && \text{Factor} \\ &= \frac{\cancel{-(w - 3)}}{\cancel{(w - 3)}(w + 3)} && \text{Cancel common factors} \\ &= \frac{-1}{w + 3} && \text{Provided } w \neq 3 \end{aligned}$$

The stipulation $w \neq 3$ comes from the cancellation of the $(w - 3)$ factor.

3. In this next example, we are asked to add two rational expressions with *different* denominators. As with numeric fractions, we must first find a *common denominator*. To do so, we start by factoring each of the denominators.

$$\begin{aligned} \frac{3}{y^2 - 8y + 16} + \frac{y + 1}{16y - y^3} &= \frac{3}{(y - 4)^2} + \frac{y + 1}{y(16 - y^2)} && \text{Factor} \\ &= \frac{3}{(y - 4)^2} + \frac{y + 1}{y(4 - y)(4 + y)} && \text{Factor some more} \end{aligned}$$

To find the common denominator, we examine the factors in the first denominator and note that we need a factor of $(y - 4)^2$. We now look at the second denominator to see what other factors we need. We need a factor of y and $(4 + y) = (y + 4)$. What about $(4 - y)$? As mentioned in the last example, we can factor this as: $(4 - y) = -(y - 4)$. Using properties of negatives, we ‘migrate’ this negative out to the front of the fraction, turning the addition into subtraction. We find the (least) common denominator to be $(y - 4)^2 y (y + 4)$. We can now proceed to multiply the numerator and denominator of each fraction by whatever factors each is missing from their respective denominators to produce equivalent expressions with

common denominators.

$$\begin{aligned}
 \frac{3}{(y-4)^2} + \frac{y+1}{y(4-y)(4+y)} &= \frac{3}{(y-4)^2} + \frac{y+1}{y(-(y-4))(y+4)} \\
 &= \frac{3}{(y-4)^2} - \frac{y+1}{y(y-4)(y+4)} \\
 &= \frac{3}{(y-4)^2} \cdot \frac{y(y+4)}{y(y+4)} - \frac{y+1}{y(y-4)(y+4)} \cdot \frac{(y-4)}{(y-4)} && \text{Equivalent Fractions} \\
 &= \frac{3y(y+4)}{(y-4)^2y(y+4)} - \frac{(y+1)(y-4)}{y(y-4)^2(y+4)} && \text{Multiply Fractions}
 \end{aligned}$$

At this stage, we can subtract numerators and simplify. We'll keep the denominator factored (in case we can reduce down later), but in the numerator, since there are no common factors, we proceed to perform the indicated multiplication and combine like terms.

$$\begin{aligned}
 \frac{3y(y+4)}{(y-4)^2y(y+4)} - \frac{(y+1)(y-4)}{y(y-4)^2(y+4)} &= \frac{3y(y+4) - (y+1)(y-4)}{(y-4)^2y(y+4)} && \text{Subtract numerators} \\
 &= \frac{3y^2 + 12y - (y^2 - 3y - 4)}{(y-4)^2y(y+4)} && \text{Distribute} \\
 &= \frac{3y^2 + 12y - y^2 + 3y + 4}{(y-4)^2y(y+4)} && \text{Distribute} \\
 &= \frac{2y^2 + 15y + 4}{y(y+4)(y-4)^2} && \text{Gather like terms}
 \end{aligned}$$

We would like to factor the numerator and cancel factors it has in common with the denominator. After a few attempts, it appears as if the numerator doesn't factor, at least over the integers. As a check, we compute the discriminant of $2y^2 + 15y + 4$ and get $15^2 - 4(2)(4) = 193$. This isn't a perfect square so we know that the quadratic equation $2y^2 + 15y + 4 = 0$ has irrational solutions. This means $2y^2 + 15y + 4$ can't factor over the integers³ so we are done.

4. In this example, we have a compound fraction, and we proceed to simplify it as we did its numeric counterparts in Example 0.2.1. Specifically, we start by multiplying the numerator and denominator of the 'big' fraction by the least common denominator of the 'little' fractions inside of it - in this case we need to use $(4 - (x+h))(4-x)$ - to remove the compound nature of the 'big' fraction. Once we have a more normal looking fraction, we can proceed as we

³See the remarks following Theorem 0.10.

have in the previous examples.

$$\begin{aligned}
 \frac{\frac{2}{4-(x+h)} - \frac{2}{4-x}}{h} &= \frac{\left(\frac{2}{4-(x+h)} - \frac{2}{4-x}\right)}{h} \cdot \frac{(4-(x+h))(4-x)}{(4-(x+h))(4-x)} && \text{Equivalent fractions} \\
 &= \frac{\left(\frac{2}{4-(x+h)} - \frac{2}{4-x}\right) \cdot (4-(x+h))(4-x)}{h(4-(x+h))(4-x)} && \text{Multiply} \\
 &= \frac{\frac{2(4-(x+h))(4-x)}{4-(x+h)} - \frac{2(4-(x+h))(4-x)}{4-x}}{h(4-(x+h))(4-x)} && \text{Distribute} \\
 &= \frac{\frac{2\cancel{(4-(x+h))}(4-x)}{\cancel{(4-(x+h))}} - \frac{2(4-(x+h))\cancel{(4-x)}}{\cancel{(4-x)}}}{h(4-(x+h))(4-x)} && \text{Reduce} \\
 &= \frac{2(4-x) - 2(4-(x+h))}{h(4-(x+h))(4-x)}
 \end{aligned}$$

Now we can clean up and factor the numerator to see if anything cancels. (This why we kept the denominator factored.)

$$\begin{aligned}
 \frac{2(4-x) - 2(4-(x+h))}{h(4-(x+h))(4-x)} &= \frac{2[(4-x) - (4-(x+h))]}{h(4-(x+h))(4-x)} && \text{Factor out G.C.F.} \\
 &= \frac{2[4-x-4+(x+h)]}{h(4-(x+h))(4-x)} && \text{Distribute} \\
 &= \frac{2[4-4-x+x+h]}{h(4-(x+h))(4-x)} && \text{Rearrange terms} \\
 &= \frac{2h}{h(4-(x+h))(4-x)} && \text{Gather like terms} \\
 &= \frac{2\cancel{h}}{\cancel{h}(4-(x+h))(4-x)} && \text{Reduce} \\
 &= \frac{2}{(4-(x+h))(4-x)} && \text{Provided } h \neq 0
 \end{aligned}$$

Your instructor will let you know if you are to multiply out the denominator or not.⁴

5. At first glance, it doesn't seem as if there is anything that can be done with $2t^{-3} - (3t)^{-2}$ because the exponents on the variables are different. However, since the exponents are negative, these are actually rational expressions. In the first term, the -3 exponent applies to the

⁴We'll keep it factored because in Calculus it needs to be factored.

t only but in the second term, the exponent -2 applies to *both* the 3 and the t , as indicated by the parentheses. One way to proceed is as follows:

$$\begin{aligned} 2t^{-3} - (3t)^{-2} &= \frac{2}{t^3} - \frac{1}{(3t)^2} \\ &= \frac{2}{t^3} - \frac{1}{9t^2} \end{aligned}$$

We see that we are being asked to subtract two rational expressions with different denominators, so we need to find a common denominator. The first fraction contributes a t^3 to the denominator, while the second contributes a factor of 9. Thus our common denominator is $9t^3$, so we are missing a factor of ‘9’ in the first denominator and a factor of ‘ t ’ in the second.

$$\begin{aligned} \frac{2}{t^3} - \frac{1}{9t^2} &= \frac{2}{t^3} \cdot \frac{9}{9} - \frac{1}{9t^2} \cdot \frac{t}{t} && \text{Equivalent Fractions} \\ &= \frac{18}{9t^3} - \frac{t}{9t^3} && \text{Multiply} \\ &= \frac{18 - t}{9t^3} && \text{Subtract} \end{aligned}$$

We find no common factors among the numerator and denominator so we are done.

A second way to approach this problem is by factoring. We can extend the concept of the ‘Polynomial G.C.F.’ to these types of expressions and we can follow the same guidelines as set forth on page 72 to factor out the G.C.F. of these two terms. The key ideas to remember are that we take out each factor with the *smallest* exponent and factoring is the same as dividing. We first note that $2t^{-3} - (3t)^{-2} = 2t^{-3} - 3^{-2}t^{-2}$ and we see that the smallest power on t is -3 . Thus we want to factor out t^{-3} from both terms. It’s clear that this will leave 2 in the first term, but what about the second term? Since factoring is the same as dividing, we would be dividing the second term by t^{-3} which thanks to the properties of exponents is the same as *multiplying* by $\frac{1}{t^{-3}} = t^3$. The same holds for 3^{-2} . Even though there are no factors of 3 in the first term, we can factor out 3^{-2} by multiplying it by $\frac{1}{3^{-2}} = 3^2 = 9$. We put these ideas together below.

$$\begin{aligned} 2t^{-3} - (3t)^{-2} &= 2t^{-3} - 3^{-2}t^{-2} && \text{Properties of Exponents} \\ &= 3^{-2}t^{-3}(2(3)^2 - t^1) && \text{Factor} \\ &= \frac{1}{3^2} \frac{1}{t^3} (18 - t) && \text{Rewrite} \\ &= \frac{18 - t}{9t^3} && \text{Multiply} \end{aligned}$$

While both ways are valid, one may be more of a natural fit than the other depending on the circumstances and temperament of the student.

6. As with the previous example, we show two different yet equivalent ways to approach simplifying $10x(x-3)^{-1} + 5x^2(-1)(x-3)^{-2}$. First up is what we'll call the 'common denominator approach' where we rewrite the negative exponents as fractions and proceed from there.

- *Common Denominator Approach:*

$$\begin{aligned}
 10x(x-3)^{-1} + 5x^2(-1)(x-3)^{-2} &= \frac{10x}{x-3} + \frac{5x^2(-1)}{(x-3)^2} \\
 &= \frac{10x}{x-3} \cdot \frac{x-3}{x-3} - \frac{5x^2}{(x-3)^2} && \text{Equivalent Fractions} \\
 &= \frac{10x(x-3)}{(x-3)^2} - \frac{5x^2}{(x-3)^2} && \text{Multiply} \\
 &= \frac{10x(x-3) - 5x^2}{(x-3)^2} && \text{Subtract} \\
 &= \frac{5x(2(x-3) - x)}{(x-3)^2} && \text{Factor out G.C.F.} \\
 &= \frac{5x(2x - 6 - x)}{(x-3)^2} && \text{Distribute} \\
 &= \frac{5x(x-6)}{(x-3)^2} && \text{Combine like terms}
 \end{aligned}$$

Both the numerator and the denominator are completely factored with no common factors so we are done.

- '*Factoring Approach*': In this case, the G.C.F. is $5x(x-3)^{-2}$. Factoring this out of both terms gives:

$$\begin{aligned}
 10x(x-3)^{-1} + 5x^2(-1)(x-3)^{-2} &= 5x(x-3)^{-2}(2(x-3)^1 - x) && \text{Factor} \\
 &= \frac{5x}{(x-3)^2}(2x - 6 - x) && \text{Rewrite, distribute} \\
 &= \frac{5x(x-6)}{(x-3)^2} && \text{Multiply}
 \end{aligned}$$

As expected, we got the same reduced fraction as before. □

Next, we review the solving of equations which involve rational expressions. As with equations involving numeric fractions, our first step in solving equations with algebraic fractions is to clear denominators. In doing so, we run the risk of introducing what are known as **extraneous** solutions - 'answers' which don't satisfy the original equation. As we illustrate the techniques used to solve these basic equations, see if you can find the step which creates the problem for us.

Example 0.8.2. Solve the following equations.

1. $1 + \frac{1}{x} = x$

2. $\frac{t^3 - 2t + 1}{t - 1} = \frac{1}{2}t - 1$

3. $\frac{3}{1 - w\sqrt{2}} - \frac{1}{2w + 5} = 0$

4. $3(x^2 + 4)^{-1} + 3x(-1)(x^2 + 4)^{-2}(2x) = 0$

5. Solve $x = \frac{2y + 1}{y - 3}$ for y .

6. Solve $\frac{1}{f} = \frac{1}{S_1} + \frac{1}{S_2}$ for S_1 .

Solution.

1. Our first step is to clear the fractions by multiplying both sides of the equation by x . In doing so, we are implicitly assuming $x \neq 0$; otherwise, we would have no guarantee that the resulting equation is equivalent to our original equation.⁵

$$\begin{aligned}
 1 + \frac{1}{x} &= x \\
 \left(1 + \frac{1}{x}\right)x &= (x)x && \text{Provided } x \neq 0 \\
 1(x) + \frac{1}{x}(x) &= x^2 && \text{Distribute} \\
 x + \frac{x}{x} &= x^2 && \text{Multiply} \\
 x + 1 &= x^2 \\
 0 &= x^2 - x - 1 && \text{Subtract } x, \text{ subtract } 1 \\
 x &= \frac{-(-1) \pm \sqrt{(-1)^2 - 4(1)(-1)}}{2(1)} && \text{Quadratic Formula} \\
 x &= \frac{1 \pm \sqrt{5}}{2} && \text{Simplify}
 \end{aligned}$$

We obtain two answers, $x = \frac{1 \pm \sqrt{5}}{2}$. Neither of these are 0 thus neither contradicts our assumption that $x \neq 0$. The reader is invited to check both of these solutions.⁶

⁵See page 39.

⁶The check relies on being able to ‘rationalize’ the denominator - a skill we haven’t reviewed yet. (Come back after you’ve read Section 0.9 if you want to!) Additionally, the positive solution to this equation is the famous [Golden Ratio](#).

2. To solve the equation, we clear denominators. Here, we need to assume $t - 1 \neq 0$, or $t \neq 1$.

$$\begin{aligned} \frac{t^3 - 2t + 1}{t - 1} &= \frac{1}{2}t - 1 \\ \left(\frac{t^3 - 2t + 1}{t - 1}\right) \cdot 2(t - 1) &= \left(\frac{1}{2}t - 1\right) \cdot 2(t - 1) && \text{Provided } t \neq 1 \\ \frac{(t^3 - 2t + 1)(\cancel{2(t - 1)})}{\cancel{(t - 1)}} &= \frac{1}{2}t(\cancel{2(t - 1)}) - 1(2(t - 1)) && \text{Multiply, distribute} \\ 2(t^3 - 2t + 1) &= t^2 - t - 2t + 2 && \text{Distribute} \\ 2t^3 - 4t + 2 &= t^2 - 3t + 2 && \text{Distribute, combine like terms} \\ 2t^3 - t^2 - t &= 0 && \text{Subtract } t^2, \text{ add } 3t, \text{ subtract } 2 \\ t(2t^2 - t - 1) &= 0 && \text{Factor} \\ t = 0 \text{ or } 2t^2 - t - 1 &= 0 && \text{Zero Product Property} \\ t = 0 \text{ or } (2t + 1)(t - 1) &= 0 && \text{Factor} \\ t = 0 \text{ or } 2t + 1 = 0 \text{ or } t - 1 = 0 &&& \\ t &= 0, -\frac{1}{2} \text{ or } 1 \end{aligned}$$

We assumed that $t \neq 1$ in order to clear denominators. Sure enough, the ‘solution’ $t = 1$ doesn’t check in the original equation since it causes division by 0. In this case, we call $t = 1$ an *extraneous* solution. Note that $t = 1$ *does* work in every equation *after* we clear denominators. In general, multiplying by variable expressions can produce these ‘extra’ solutions, which is why checking our answers is always encouraged.⁷ The other two solutions, $t = 0$ and $t = -\frac{1}{2}$, both work.

3. As before, we begin by clearing denominators. Here, we assume $1 - w\sqrt{2} \neq 0$ (so $w \neq \frac{1}{\sqrt{2}}$) and $2w + 5 \neq 0$ (so $w \neq -\frac{5}{2}$).

$$\begin{aligned} \frac{3}{1 - w\sqrt{2}} - \frac{1}{2w + 5} &= 0 \\ \left(\frac{3}{1 - w\sqrt{2}} - \frac{1}{2w + 5}\right) (1 - w\sqrt{2})(2w + 5) &= 0(1 - w\sqrt{2})(2w + 5) \quad w \neq \frac{1}{\sqrt{2}}, -\frac{5}{2} \\ \frac{3(\cancel{1 - w\sqrt{2}})(2w + 5)}{\cancel{(1 - w\sqrt{2})}} - \frac{1(\cancel{1 - w\sqrt{2}})(\cancel{2w + 5})}{\cancel{(2w + 5)}} &= 0 && \text{Distribute} \\ 3(2w + 5) - (1 - w\sqrt{2}) &= 0 \end{aligned}$$

The result is a *linear* equation in w so we gather the terms with w on one side of the equation

⁷Contrast this with what happened in Example 0.6.3 when we divided by a variable and ‘lost’ a solution.

and put everything else on the other. We factor out w and divide by its coefficient.

$$\begin{aligned}
 3(2w + 5) - (1 - w\sqrt{2}) &= 0 \\
 6w + 15 - 1 + w\sqrt{2} &= 0 && \text{Distribute} \\
 6w + w\sqrt{2} &= -14 && \text{Subtract 14} \\
 (6 + \sqrt{2})w &= -14 && \text{Factor} \\
 w &= -\frac{14}{6 + \sqrt{2}} && \text{Divide by } 6 + \sqrt{2}
 \end{aligned}$$

This solution is different than our excluded values, $\frac{1}{\sqrt{2}}$ and $-\frac{5}{2}$, so we keep $w = -\frac{14}{6+\sqrt{2}}$ as our final answer. The reader is invited to check this in the original equation.

4. To solve our next equation, we have two approaches to choose from: we could rewrite the quantities with negative exponents as fractions and clear denominators, or we can factor. We showcase each technique below.

- *Clearing Denominators Approach:* We rewrite the negative exponents as fractions and clear denominators. In this case, we multiply both sides of the equation by $(x^2 + 4)^2$, which is never 0. (Think about that for a moment.) As a result, we need not exclude any x values from our solution set.

$$\begin{aligned}
 3(x^2 + 4)^{-1} + 3x(-1)(x^2 + 4)^{-2}(2x) &= 0 \\
 \frac{3}{x^2 + 4} + \frac{3x(-1)(2x)}{(x^2 + 4)^2} &= 0 && \text{Rewrite} \\
 \left(\frac{3}{x^2 + 4} - \frac{6x^2}{(x^2 + 4)^2} \right) (x^2 + 4)^2 &= 0(x^2 + 4)^2 && \text{Multiply} \\
 \frac{3(x^2 + 4)^{\cancel{2}} - 6x^2(x^2 + 4)^{\cancel{2}}}{(x^2 + 4)} &= 0 && \text{Distribute} \\
 3(x^2 + 4) - 6x^2 &= 0 \\
 3x^2 + 12 - 6x^2 &= 0 && \text{Distribute} \\
 -3x^2 &= -12 && \text{Combine like terms, subtract 12} \\
 x^2 &= 4 && \text{Divide by } -3 \\
 x &= \pm\sqrt{4} = \pm 2 && \text{Extract square roots}
 \end{aligned}$$

We leave it to the reader to show both $x = -2$ and $x = 2$ satisfy the original equation.

- *Factoring Approach:* Since the equation is already set equal to 0, we're ready to factor. Following the guidelines presented in Example 0.8.1, we factor out $3(x^2 + 4)^{-2}$ from both

terms and look to see if more factoring can be done:

$$\begin{aligned}
 3(x^2 + 4)^{-1} + 3x(-1)(x^2 + 4)^{-2}(2x) &= 0 \\
 3(x^2 + 4)^{-2}((x^2 + 4)^1 + x(-1)(2x)) &= 0 && \text{Factor} \\
 3(x^2 + 4)^{-2}(x^2 + 4 - 2x^2) &= 0 \\
 3(x^2 + 4)^{-2}(4 - x^2) &= 0 && \text{Gather like terms} \\
 3(x^2 + 4)^{-2} = 0 \text{ or } 4 - x^2 = 0 & \text{ Zero Product Property} \\
 \frac{3}{x^2 + 4} = 0 \text{ or } 4 = x^2 &
 \end{aligned}$$

The first equation yields no solutions (Think about this for a moment.) while the second gives us $x = \pm\sqrt{4} = \pm 2$ as before.

5. We are asked to solve this equation for y so we begin by clearing fractions with the stipulation that $y - 3 \neq 0$ or $y \neq 3$. We are left with a linear equation in the variable y . To solve this, we gather the terms containing y on one side of the equation and everything else on the other. Next, we factor out the y and divide by its coefficient, which in this case turns out to be $x - 2$. In order to divide by $x - 2$, we stipulate $x - 2 \neq 0$ or, said differently, $x \neq 2$.

$$\begin{aligned}
 x &= \frac{2y + 1}{y - 3} \\
 x(y - 3) &= \left(\frac{2y + 1}{y - 3}\right)(y - 3) && \text{Provided } y \neq 3 \\
 xy - 3x &= \frac{(2y + 1)(\cancel{y - 3})}{\cancel{(y - 3)}} && \text{Distribute, multiply} \\
 xy - 3x &= 2y + 1 \\
 xy - 2y &= 3x + 1 && \text{Add } 3x, \text{ subtract } 2y \\
 y(x - 2) &= 3x + 1 && \text{Factor} \\
 y &= \frac{3x + 1}{x - 2} && \text{Divide provided } x \neq 2
 \end{aligned}$$

We highly encourage the reader to check the answer algebraically to see where the restrictions on x and y come into play.⁸

6. Our last example comes from physics and the world of photography.⁹ We take a moment here to note that while superscripts in mathematics indicate exponents (powers), subscripts are used primarily to distinguish one or more variables. In this case, S_1 and S_2 are two *different* variables (much like x and y) and we treat them as such. Our first step is to clear denominators by multiplying both sides by fS_1S_2 - provided each is nonzero. We end up with

⁸It involves simplifying a compound fraction!

⁹See this article on [focal length](#).

an equation which is linear in S_1 so we proceed as in the previous example.

$$\begin{aligned} \frac{1}{f} &= \frac{1}{S_1} + \frac{1}{S_2} \\ \left(\frac{1}{f}\right)(fS_1S_2) &= \left(\frac{1}{S_1} + \frac{1}{S_2}\right)(fS_1S_2) \quad \text{Provided } f \neq 0, S_1 \neq 0, S_2 \neq 0 \\ \frac{fS_1S_2}{f} &= \frac{fS_1S_2}{S_1} + \frac{fS_1S_2}{S_2} && \text{Multiply, distribute} \\ \frac{fS_1S_2}{f} &= \frac{f\cancel{S_1}S_2}{\cancel{S_1}} + \frac{fS_1\cancel{S_2}}{\cancel{S_2}} && \text{Cancel} \\ S_1S_2 &= fS_2 + fS_1 \\ S_1S_2 - fS_1 &= fS_2 && \text{Subtract } fS_1 \\ S_1(S_2 - f) &= fS_2 && \text{Factor} \\ S_1 &= \frac{fS_2}{S_2 - f} && \text{Divide provided } S_2 \neq f \end{aligned}$$

As always, the reader is highly encouraged to check the answer.¹⁰

□

¹⁰...and see what the restriction $S_2 \neq f$ means in terms of focusing a camera!

0.8.1 EXERCISES

In Exercises 1 - 18, perform the indicated operations and simplify.

1. $\frac{x^2 - 9}{x^2} \cdot \frac{3x}{x^2 - x - 6}$
2. $\frac{t^2 - 2t}{t^2 + 1} \div (3t^2 - 2t - 8)$
3. $\frac{4y - y^2}{2y + 1} \div \frac{y^2 - 16}{2y^2 - 5y - 3}$
4. $\frac{x}{3x - 1} - \frac{1 - x}{3x - 1}$
5. $\frac{2}{w - 1} - \frac{w^2 + 1}{w - 1}$
6. $\frac{2 - y}{3y} - \frac{1 - y}{3y} + \frac{y^2 - 1}{3y}$
7. $b + \frac{1}{b - 3} - 2$
8. $\frac{2x}{x - 4} - \frac{1}{2x + 1}$
9. $\frac{m^2}{m^2 - 4} + \frac{1}{2 - m}$
10. $\frac{\frac{2}{x} - 2}{x - 1}$
11. $\frac{\frac{3}{2 - h} - \frac{3}{2}}{h}$
12. $\frac{\frac{1}{x + h} - \frac{1}{x}}{h}$
13. $3w^{-1} - (3w)^{-1}$
14. $-2y^{-1} + 2(3 - y)^{-2}$
15. $3(x - 2)^{-1} - 3x(x - 2)^{-2}$
16. $\frac{t^{-1} + t^{-2}}{t^{-3}}$
17. $\frac{2(3 + h)^{-2} - 2(3)^{-2}}{h}$
18. $\frac{(7 - x - h)^{-1} - (7 - x)^{-1}}{h}$

In Exercises 19 - 27, find all real solutions. Be sure to check for extraneous solutions.

19. $\frac{x}{5x + 4} = 3$
20. $\frac{3y - 1}{y^2 + 1} = 1$
21. $\frac{1}{w + 3} + \frac{1}{w - 3} = \frac{w^2 - 3}{w^2 - 9}$
22. $\frac{2x + 17}{x + 1} = x + 5$
23. $\frac{t^2 - 2t + 1}{t^3 + t^2 - 2t} = 1$
24. $\frac{-y^3 + 4y}{y^2 - 9} = 4y$
25. $w + \sqrt{3} = \frac{3w - w^3}{w - \sqrt{3}}$
26. $\frac{2}{x\sqrt{2} - 1} - 1 = \frac{3}{x\sqrt{2} + 1}$
27. $\frac{x^2}{(1 + x\sqrt{3})^2} = 3$

In Exercises 28 - 30, use Theorem 0.3 along with the techniques in this section to find all real solutions.

28. $\left| \frac{3n}{n - 1} \right| = 3$
29. $\left| \frac{2x}{x^2 - 1} \right| = 2$
30. $\left| \frac{2t}{4 - t^2} \right| = \left| \frac{2}{t - 2} \right|$

In Exercises 31 - 33, find all real solutions and use a calculator to approximate your answers, rounded to two decimal places.

31. $2.41 = \frac{0.08}{4\pi R^2}$
32. $\frac{x^2}{(2.31 - x)^2} = 0.04$
33. $1 - \frac{6.75 \times 10^{16}}{c^2} = \frac{1}{4}$

In Exercises 34 - 39, solve the given equation for the indicated variable.

34. Solve for y : $\frac{1-2y}{y+3} = x$

35. Solve for y : $x = 3 - \frac{2}{1-y}$

36.¹¹Solve for T_2 : $\frac{V_1}{T_1} = \frac{V_2}{T_2}$

37. Solve for t_0 : $\frac{t_0}{1-t_0t_1} = 2$

38. Solve for x : $\frac{1}{x-v_r} + \frac{1}{x+v_r} = 5$

39. Solve for R : $P = \frac{25R}{(R+4)^2}$

¹¹Recall: subscripts on variables have no intrinsic mathematical meaning; they're just used to distinguish one variable from another. In other words, treat quantities like ' V_1 ' and ' V_2 ' as two different variables as you would ' x ' and ' y .'

0.8.2 ANSWERS

1. $\frac{3(x+3)}{x(x+2)}, x \neq 3$
2. $\frac{t}{(3t+4)(t^2+1)}, t \neq 2$
3. $-\frac{y(y-3)}{y+4}, y \neq -\frac{1}{2}, 3, 4$
4. $\frac{2x-1}{3x-1}$
5. $-w-1, w \neq 1$
6. $\frac{y}{3}, y \neq 0$
7. $\frac{b^2-5b+7}{b-3}$
8. $\frac{4x^2+x+4}{(x-4)(2x+1)}$
9. $\frac{m+1}{m+2}, m \neq 2$
10. $-\frac{2}{x}, x \neq 1$
11. $\frac{3}{4-2h}, h \neq 0$
12. $-\frac{1}{x(x+h)}, h \neq 0$
13. $\frac{8}{3w}$
14. $-\frac{2(y^2-7y+9)}{y(y-3)^2}$
15. $-\frac{6}{(x-2)^2}$
16. $t^2+t, t \neq 0$
17. $-\frac{2(h+6)}{9(h+3)^2}, h \neq 0$
18. $\frac{1}{(7-x)(7-x-h)}, h \neq 0$
19. $x = -\frac{6}{7}$
20. $y = 1, 2$
21. $w = -1$
22. $x = -6, 2$
23. No solution.
24. $y = 0, \pm 2\sqrt{2}$
25. $w = -\sqrt{3}, -1$
26. $x = -\frac{3\sqrt{2}}{2}, \sqrt{2}$
27. $x = -\frac{\sqrt{3}}{2}, -\frac{\sqrt{3}}{4}$
28. $n = \frac{1}{2}$
29. $x = \frac{1 \pm \sqrt{5}}{2}, \frac{-1 \pm \sqrt{5}}{2}$
30. $t = -1$
31. $R = \pm \sqrt{\frac{0.08}{9.64\pi}} \approx \pm 0.05$
32. $x = -\frac{231}{400} \approx -0.58, x = \frac{77}{200} \approx 0.38$
33. $c = \pm \sqrt{\frac{4 \cdot 6.75 \times 10^{16}}{3}} = \pm 3.00 \times 10^8$ (You actually didn't need a calculator for this!)
34. $y = \frac{1-3x}{x+2}, y \neq -3, x \neq -2$
35. $y = \frac{x-1}{x-3}, y \neq 1, x \neq 3$
36. $T_2 = \frac{V_2 T_1}{V_1}, T_1 \neq 0, T_2 \neq 0, V_1 \neq 0$
37. $t_0 = \frac{2}{2t_1+1}, t_1 \neq -\frac{1}{2}$
38. $x = \frac{1 \pm \sqrt{25v_r^2+1}}{5}, x \neq \pm v_r.$
39. $R = \frac{-(8P-25) \pm \sqrt{(8P-25)^2-64P^2}}{2P} = \frac{(25-8P) \pm 5\sqrt{25-16P}}{2P}, P \neq 0, R \neq -4$

0.9 RADICALS AND EQUATIONS

In this section we review simplifying expressions and solving equations involving radicals. In addition to the product, quotient and power rules stated in Theorem 0.1 in Section 0.2, we present the following result which states that n^{th} roots and n^{th} powers more or less ‘undo’ each other.¹

Theorem 0.11. Simplifying n^{th} powers of n^{th} roots: Suppose n is a natural number, a is a real number and $\sqrt[n]{a}$ is a real number. Then

- $(\sqrt[n]{a})^n = a$
- if n is odd, $\sqrt[n]{a^n} = a$; if n is even, $\sqrt[n]{a^n} = |a|$.

Since $\sqrt[n]{a}$ is *defined* so that $(\sqrt[n]{a})^n = a$, the first claim in the theorem is just a re-wording of Definition 0.8. The second part of the theorem breaks down along odd/even exponent lines due to how exponents affect negatives. To see this, consider the specific cases of $\sqrt[3]{(-2)^3}$ and $\sqrt[4]{(-2)^4}$.

In the first case, $\sqrt[3]{(-2)^3} = \sqrt[3]{-8} = -2$, so we have an instance of when $\sqrt[n]{a^n} = a$. The reason that the cube root ‘undoes’ the third power in $\sqrt[3]{(-2)^3} = -2$ is because the negative is preserved when raised to the third (odd) power. In $\sqrt[4]{(-2)^4}$, the negative ‘goes away’ when raised to the fourth (even) power: $\sqrt[4]{(-2)^4} = \sqrt[4]{16}$. According to Definition 0.8, the fourth root is defined to give only *non-negative* numbers, so $\sqrt[4]{16} = 2$. Here we have a case where $\sqrt[4]{(-2)^4} = 2 = |-2|$, not -2 .

In general, we need the absolute values to simplify $\sqrt[n]{a^n}$ only when n is even because a negative to an even power is always positive. In particular, $\sqrt{x^2} = |x|$, not just ‘ x ’ (unless we *know* $x \geq 0$).² We practice these formulas in the following example.

Example 0.9.1. Perform the indicated operations and simplify.

1. $\sqrt{x^2 + 1}$
2. $\sqrt{t^2 - 10t + 25}$
3. $\sqrt[3]{48x^{14}}$
4. $\sqrt[4]{\frac{\pi r^4}{L^8}}$
5. $2x\sqrt[3]{x^2 - 4} + 2\left(\frac{1}{2(\sqrt[3]{x^2 - 4})^2}\right)(2x)$
6. $\sqrt{(\sqrt{18y} - \sqrt{8y})^2 + (\sqrt{20} - \sqrt{80})^2}$

Solution.

1. We told you back on page 33 that roots do not ‘distribute’ across addition and since $x^2 + 1$ cannot be factored over the real numbers, $\sqrt{x^2 + 1}$ cannot be simplified. It may seem silly to start with this example but it is extremely important that you understand what maneuvers are legal and which ones are not.³

¹See Section 5.3 for a more precise understanding of what we mean here.

²If this discussion sounds familiar, see the discussion following Definition 5.5 and the discussion following ‘Extracting the Square Root’ on page 84.

³You really do need to understand this otherwise horrible evil will plague your future studies in Math. If you say something totally wrong like $\sqrt{x^2 + 1} = x + 1$ then you may never pass Calculus. PLEASE be careful!

2. Again we note that $\sqrt{t^2 - 10t + 25} \neq \sqrt{t^2} - \sqrt{10t} + \sqrt{25}$, since radicals do *not* distribute across addition and subtraction.⁴ In this case, however, we can factor the radicand and simplify as

$$\sqrt{t^2 - 10t + 25} = \sqrt{(t - 5)^2} = |t - 5|$$

Without knowing more about the value of t , we have no idea if $t - 5$ is positive or negative so $|t - 5|$ is our final answer.⁵

3. To simplify $\sqrt[3]{48x^{14}}$, we need to look for perfect cubes in the radicand. For the coefficient, we have $48 = 8 \cdot 6 = 2^3 \cdot 6$. To find the largest perfect cube factor in x^{14} , we divide 14 (the exponent on x) by 3 (since we are looking for a perfect *cube*). We get 4 with a remainder of 2. This means $14 = 4 \cdot 3 + 2$, so $x^{14} = x^{4 \cdot 3 + 2} = x^{4 \cdot 3} x^2 = (x^4)^3 x^2$. Putting this altogether gives:

$$\begin{aligned} \sqrt[3]{48x^{14}} &= \sqrt[3]{2^3 \cdot 6 \cdot (x^4)^3 x^2} && \text{Factor out perfect cubes} \\ &= \sqrt[3]{2^3} \sqrt[3]{(x^4)^3} \sqrt[3]{6x^2} && \text{Rearrange factors, Product Rule of Radicals} \\ &= 2x^4 \sqrt[3]{6x^2} \end{aligned}$$

4. In this example, we are looking for perfect fourth powers in the radicand. In the numerator r^4 is clearly a perfect fourth power. For the denominator, we take the power on the L , namely 12, and divide by 4 to get 3. This means $L^8 = L^{2 \cdot 4} = (L^2)^4$. We get

$$\begin{aligned} \sqrt[4]{\frac{\pi r^4}{L^{12}}} &= \frac{\sqrt[4]{\pi r^4}}{\sqrt[4]{L^{12}}} && \text{Quotient Rule of Radicals} \\ &= \frac{\sqrt[4]{\pi} \sqrt[4]{r^4}}{\sqrt[4]{(L^2)^4}} && \text{Product Rule of Radicals} \\ &= \frac{\sqrt[4]{\pi} |r|}{|L^2|} && \text{Simplify} \end{aligned}$$

Without more information about r , we cannot simplify $|r|$ any further. However, we can simplify $|L^2|$. Regardless of the choice of L , $L^2 \geq 0$. Actually, $L^2 > 0$ because L is in the denominator which means $L \neq 0$. Hence, $|L^2| = L^2$. Our answer simplifies to:

$$\frac{\sqrt[4]{\pi} |r|}{|L^2|} = \frac{|r| \sqrt[4]{\pi}}{L^2}$$

5. After a quick cancellation (two of the 2's in the second term) we need to obtain a common denominator. Since we can view the first term as having a denominator of 1, the common denominator is precisely the denominator of the second term, namely $(\sqrt[3]{x^2 - 4})^2$. With

⁴Let $t = 1$ and see what happens to $\sqrt{t^2 - 10t + 25}$ versus $\sqrt{t^2} - \sqrt{10t} + \sqrt{25}$.

⁵In general, $|t - 5| \neq |t| - |5|$ and $|t - 5| \neq t + 5$ so watch what you're doing!

common denominators, we proceed to add the two fractions. Our last step is to factor the numerator to see if there are any cancellation opportunities with the denominator.

$$\begin{aligned}
 2x\sqrt[3]{x^2-4} + 2\left(\frac{1}{2(\sqrt[3]{x^2-4})^2}\right)(2x) &= 2x\sqrt[3]{x^2-4} + \cancel{2}\left(\frac{1}{\cancel{2}(\sqrt[3]{x^2-4})^2}\right)(2x) && \text{Reduce} \\
 &= 2x\sqrt[3]{x^2-4} + \frac{2x}{(\sqrt[3]{x^2-4})^2} && \text{Multiply} \\
 &= (2x\sqrt[3]{x^2-4}) \cdot \frac{(\sqrt[3]{x^2-4})^2}{(\sqrt[3]{x^2-4})^2} + \frac{2x}{(\sqrt[3]{x^2-4})^2} && \text{Equivalent} \\
 &= \frac{2x(\sqrt[3]{x^2-4})^3}{(\sqrt[3]{x^2-4})^2} + \frac{2x}{(\sqrt[3]{x^2-4})^2} && \text{fractions} \\
 &= \frac{2x(x^2-4)}{(\sqrt[3]{x^2-4})^2} + \frac{2x}{(\sqrt[3]{x^2-4})^2} && \text{Multiply} \\
 &= \frac{2x(x^2-4)}{(\sqrt[3]{x^2-4})^2} + \frac{2x}{(\sqrt[3]{x^2-4})^2} && \text{Simplify} \\
 &= \frac{2x(x^2-4) + 2x}{(\sqrt[3]{x^2-4})^2} && \text{Add} \\
 &= \frac{2x(x^2-4+1)}{(\sqrt[3]{x^2-4})^2} && \text{Factor} \\
 &= \frac{2x(x^2-3)}{(\sqrt[3]{x^2-4})^2}
 \end{aligned}$$

We cannot reduce this any further because $x^2 - 3$ is irreducible over the rational numbers.

6. We begin by working inside each set of parentheses, using the product rule for radicals and combining like terms.

$$\begin{aligned}
 \sqrt{(\sqrt{18y} - \sqrt{8y})^2 + (\sqrt{20} - \sqrt{80})^2} &= \sqrt{(\sqrt{9 \cdot 2y} - \sqrt{4 \cdot 2y})^2 + (\sqrt{4 \cdot 5} - \sqrt{16 \cdot 5})^2} \\
 &= \sqrt{(\sqrt{9}\sqrt{2y} - \sqrt{4}\sqrt{2y})^2 + (\sqrt{4}\sqrt{5} - \sqrt{16}\sqrt{5})^2} \\
 &= \sqrt{(3\sqrt{2y} - 2\sqrt{2y})^2 + (2\sqrt{5} - 4\sqrt{5})^2} \\
 &= \sqrt{(\sqrt{2y})^2 + (-2\sqrt{5})^2} \\
 &= \sqrt{2y + (-2)^2(\sqrt{5})^2} \\
 &= \sqrt{2y + 4 \cdot 5} \\
 &= \sqrt{2y + 20}
 \end{aligned}$$

To see if this simplifies any further, we factor the radicand: $\sqrt{2y + 20} = \sqrt{2(y + 10)}$. Finding no perfect square factors, we are done. \square

Theorem 0.11 allows us to generalize the process of ‘Extracting Square Roots’ to ‘Extracting n^{th} roots’ which in turn allows us to solve equations⁶ of the form $X^n = c$.

Extracting n^{th} roots:

- If c is a real number and n is odd then the real number solution to $X^n = c$ is $X = \sqrt[n]{c}$.
 - If $c \geq 0$ and n is even then the real number solutions to $X^n = c$ are $X = \pm \sqrt[n]{c}$.
- Note:** If $c < 0$ and n is even then $X^n = c$ has no real number solutions.

Essentially, we solve $X^n = c$ by ‘taking the n^{th} root’ of both sides: $\sqrt[n]{X^n} = \sqrt[n]{c}$. Simplifying the left side gives us just X if n is odd or $|X|$ if n is even. In the first case, $X = \sqrt[n]{c}$, and in the second, $X = \pm \sqrt[n]{c}$. Putting this together with the other part of Theorem 0.11, namely $(\sqrt[n]{a})^n = a$, gives us a strategy for solving equations which involve n^{th} and n^{th} roots.

Strategies for Power and Radical Equations

- If the equation involves an n^{th} power and the variable appears in only one term, isolate the term with the n^{th} power and extract n^{th} roots.
- If the equation involves an n^{th} root and the variable appears in that n^{th} root, isolate the n^{th} root and raise both sides of the equation to the n^{th} power.

Note: When raising both sides of an equation to an *even* power, be sure to check for extraneous solutions.

The note about ‘extraneous solutions’ can be demonstrated by the basic equation: $\sqrt{x} = -2$. This equation has no solution since, by definition, $\sqrt{x} \geq 0$ for all real numbers x . However, if we square both sides of this equation, we get $(\sqrt{x})^2 = (-2)^2$ or $x = 4$. However, $x = 4$ doesn’t check in the original equation, since $\sqrt{4} = 2$, not -2 . Once again, the root⁷ of all of our problems lies in the fact that a *negative* number to an *even* power results in a *positive* number. In other words, raising both sides of an equation to an even power does *not* produce an equivalent equation, but rather, an equation which may possess *more* solutions than the original. Hence the cautionary remark above about extraneous solutions.

Example 0.9.2. Solve the following equations.

1. $(5x + 3)^4 = 16$
2. $1 - \frac{(5 - 2w)^3}{7} = 9$
3. $t + \sqrt{2t + 3} = 6$
4. $\sqrt{2} - 3\sqrt[3]{2y + 1} = 0$
5. $\sqrt{4x - 1} + 2\sqrt{1 - 2x} = 1$
6. $\sqrt[4]{n^2 + 2} + n = 0$

For the remaining problems, assume that all of the variables represent positive real numbers.⁸

⁶Well, not entirely. The equation $x^7 = 1$ has seven answers: $x = 1$ and six complex number solutions.

⁷Pun intended!

⁸That is, you needn’t worry that you’re multiplying or dividing by 0 or that you’re forgetting absolute value symbols.

7. Solve for r : $V = \frac{4\pi}{3}(R^3 - r^3)$.
8. Solve for M_1 : $\frac{r_1}{r_2} = \sqrt{\frac{M_2}{M_1}}$
9. Solve for v : $m = \frac{m_0}{\sqrt{1 - \frac{v^2}{c^2}}}$. Assume all quantities represent positive real numbers.

Solution.

1. In our first equation, the quantity containing x is already isolated, so we extract fourth roots. Since the exponent here is even, when the roots are extracted we need both the positive and negative roots.

$$\begin{aligned} (5x + 3)^4 &= 16 \\ 5x + 3 &= \pm\sqrt[4]{16} && \text{Extract fourth roots} \\ 5x + 3 &= \pm 2 \\ 5x + 3 = 2 &\text{ or } 5x + 3 = -2 \\ x = -\frac{1}{5} &\text{ or } x = -1 \end{aligned}$$

We leave it to the reader that both of these solutions satisfy the original equation.

2. In this example, we first need to isolate the quantity containing the variable w . Here, third (cube) roots are required and since the exponent (index) is odd, we do not need the \pm :

$$\begin{aligned} 1 - \frac{(5 - 2w)^3}{7} &= 9 \\ -\frac{(5 - 2w)^3}{7} &= 8 && \text{Subtract 1} \\ (5 - 2w)^3 &= -56 && \text{Multiply by } -7 \\ 5 - 2w &= \sqrt[3]{-56} && \text{Extract cube root} \\ 5 - 2w &= \sqrt[3]{(-8)(7)} \\ 5 - 2w &= \sqrt[3]{-8}\sqrt[3]{7} && \text{Product Rule} \\ 5 - 2w &= -2\sqrt[3]{7} \\ -2w &= -5 - 2\sqrt[3]{7} && \text{Subtract 5} \\ w &= \frac{-5 - 2\sqrt[3]{7}}{-2} && \text{Divide by } -2 \\ w &= \frac{5 + 2\sqrt[3]{7}}{2} && \text{Properties of Negatives} \end{aligned}$$

The reader should check the answer because it provides a hearty review of arithmetic.

3. To solve $t + \sqrt{2t + 3} = 6$, we first isolate the square root, then proceed to square both sides of the equation. In doing so, we run the risk of introducing extraneous solutions so checking

our answers here is a necessity.

$$\begin{aligned}
 t + \sqrt{2t+3} &= 6 \\
 \sqrt{2t+3} &= 6 - t && \text{Subtract } t \\
 (\sqrt{2t+3})^2 &= (6-t)^2 && \text{Square both sides} \\
 2t+3 &= 36 - 12t + t^2 && \text{F.O.I.L. / Perfect Square Trinomial} \\
 0 &= t^2 - 14t + 33 && \text{Subtract } 2t \text{ and } 3 \\
 0 &= (t-3)(t-11) && \text{Factor}
 \end{aligned}$$

From the Zero Product Property, we know either $t - 3 = 0$ (which gives $t = 3$) or $t - 11 = 0$ (which gives $t = 11$). When checking our answers, we find $t = 3$ satisfies the original equation, but $t = 11$ does not.⁹ So our final answer is $t = 3$ only.

4. In our next example, we locate the variable (in this case y) beneath a cube root, so we first isolate that root and cube both sides.

$$\begin{aligned}
 \sqrt{2} - 3\sqrt[3]{2y+1} &= 0 \\
 -3\sqrt[3]{2y+1} &= -\sqrt{2} && \text{Subtract } \sqrt{2} \\
 \sqrt[3]{2y+1} &= \frac{-\sqrt{2}}{-3} && \text{Divide by } -3 \\
 \sqrt[3]{2y+1} &= \frac{\sqrt{2}}{3} && \text{Properties of Negatives} \\
 (\sqrt[3]{2y+1})^3 &= \left(\frac{\sqrt{2}}{3}\right)^3 && \text{Cube both sides} \\
 2y+1 &= \frac{(\sqrt{2})^3}{3^3} \\
 2y+1 &= \frac{2\sqrt{2}}{27} \\
 2y &= \frac{2\sqrt{2}}{27} - 1 && \text{Subtract } 1 \\
 2y &= \frac{2\sqrt{2}}{27} - \frac{27}{27} && \text{Common denominators} \\
 2y &= \frac{2\sqrt{2} - 27}{27} && \text{Subtract fractions} \\
 y &= \frac{2\sqrt{2} - 27}{54} && \text{Divide by } 2 \text{ (multiply by } \frac{1}{2})
 \end{aligned}$$

Since we raised both sides to an *odd* power, we don't need to worry about extraneous solutions but we encourage the reader to check the solution just for the fun of it.

⁹It is worth noting that when $t = 11$ is substituted into the original equation, we get $11 + \sqrt{25} = 6$. If the $+\sqrt{25}$ were $-\sqrt{25}$, the solution would check. Once again, when squaring both sides of an equation, we lose track of \pm , which is what lets extraneous solutions in the door.

5. In the equation $\sqrt{4x-1} + 2\sqrt{1-2x} = 1$, we have not one but two square roots. We begin by isolating one of the square roots and squaring both sides.

$$\begin{aligned}
 \sqrt{4x-1} + 2\sqrt{1-2x} &= 1 \\
 \sqrt{4x-1} &= 1 - 2\sqrt{1-2x} && \text{Subtract } 2\sqrt{1-2x} \text{ from both sides} \\
 (\sqrt{4x-1})^2 &= (1 - 2\sqrt{1-2x})^2 && \text{Square both sides} \\
 4x - 1 &= 1 - 4\sqrt{1-2x} + (2\sqrt{1-2x})^2 && \text{F.O.I.L. / Perfect Square Trinomial} \\
 4x - 1 &= 1 - 4\sqrt{1-2x} + 4(1-2x) \\
 4x - 1 &= 1 - 4\sqrt{1-2x} + 4 - 8x && \text{Distribute} \\
 4x - 1 &= 5 - 8x - 4\sqrt{1-2x} && \text{Gather like terms}
 \end{aligned}$$

At this point, we have just one square root so we proceed to isolate it and square both sides a second time.¹⁰

$$\begin{aligned}
 4x - 1 &= 5 - 8x - 4\sqrt{1-2x} \\
 12x - 6 &= -4\sqrt{1-2x} && \text{Subtract 5, add } 8x \\
 (12x - 6)^2 &= (-4\sqrt{1-2x})^2 && \text{Square both sides} \\
 144x^2 - 144x + 36 &= 16(1-2x) \\
 144x^2 - 144x + 36 &= 16 - 32x \\
 144x^2 - 112x + 20 &= 0 && \text{Subtract 16, add } 32x \\
 4(36x^2 - 28x + 5) &= 0 && \text{Factor} \\
 4(2x - 1)(18x - 5) &= 0 && \text{Factor some more}
 \end{aligned}$$

From the Zero Product Property, we know either $2x - 1 = 0$ or $18x - 5 = 0$. The former gives $x = \frac{1}{2}$ while the latter gives us $x = \frac{5}{18}$. Since we squared both sides of the equation (twice!), we need to check for extraneous solutions. We find $x = \frac{5}{18}$ to be extraneous, so our only solution is $x = \frac{1}{2}$.

6. As usual, our first step in solving $\sqrt[4]{n^2+2} + n = 0$ is to isolate the radical. We then proceed to raise both sides to the fourth power to eliminate the fourth root:

$$\begin{aligned}
 \sqrt[4]{n^2+2} + n &= 0 \\
 \sqrt[4]{n^2+2} &= -n && \text{Subtract } n \\
 (\sqrt[4]{n^2+2})^4 &= (-n)^4 && \text{Raise both sides to the 4}^{\text{th}} \text{ power} \\
 n^2 + 2 &= n^4 && \text{Properties of Negatives} \\
 0 &= n^4 - n^2 - 2 && \text{Subtract } n^2 \text{ and } 2 \\
 0 &= (n^2 - 2)(n^2 + 1) && \text{Factor - this is a 'Quadratic in Disguise'}
 \end{aligned}$$

At this point, the Zero Product Property gives either $n^2 - 2 = 0$ or $n^2 + 1 = 0$. From $n^2 - 2 = 0$, we get $n^2 = 2$, so $n = \pm\sqrt{2}$. From $n^2 + 1 = 0$, we get $n^2 = -1$, which gives no

¹⁰To avoid complications with fractions, we'll forego dividing by the coefficient of $\sqrt{1-2x}$, namely -4 . This is perfectly fine so long as we don't forget to square it when we square both sides of the equation.

real solutions.¹¹ Since we raised both sides to an even (the fourth) power, we need to check for extraneous solutions. We find that $n = -\sqrt{2}$ works but $n = \sqrt{2}$ is extraneous.

7. In this problem, we are asked to solve for r . While there are a lot of letters in this equation¹², r appears in only one term: r^3 . Our strategy is to isolate r^3 then extract the cube root.

$$\begin{aligned}
 V &= \frac{4\pi}{3}(R^3 - r^3) \\
 3V &= 4\pi(R^3 - r^3) && \text{Multiply by 3 to clear fractions} \\
 3V &= 4\pi R^3 - 4\pi r^3 && \text{Distribute} \\
 3V - 4\pi R^3 &= -4\pi r^3 && \text{Subtract } 4\pi R^3 \\
 \frac{3V - 4\pi R^3}{-4\pi} &= r^3 && \text{Divide by } -4\pi \\
 \frac{4\pi R^3 - 3V}{4\pi} &= r^3 && \text{Properties of Negatives} \\
 \sqrt[3]{\frac{4\pi R^3 - 3V}{4\pi}} &= r && \text{Extract the cube root}
 \end{aligned}$$

The check is, as always, left to the reader and highly encouraged.

8. The equation we are asked to solve in this example is from the world of Chemistry and is none other than [Graham's Law of effusion](#). As was mentioned in Example 0.8.2, subscripts in Mathematics are used to distinguish between variables and have no arithmetic significance. In this example, r_1 , r_2 , M_1 and M_2 are as different as x , y , z and 117. Since we are asked to solve for M_1 , we locate M_1 and see it is in a denominator in a square root. We eliminate the square root by squaring both sides and proceed from there.

$$\begin{aligned}
 \frac{r_1}{r_2} &= \sqrt{\frac{M_2}{M_1}} \\
 \left(\frac{r_1}{r_2}\right)^2 &= \left(\sqrt{\frac{M_2}{M_1}}\right)^2 && \text{Square both sides} \\
 \frac{r_1^2}{r_2^2} &= \frac{M_2}{M_1} \\
 r_1^2 M_1 &= M_2 r_2^2 && \text{Multiply by } r_2^2 M_1 \text{ to clear fractions, assume } r_2, M_1 \neq 0 \\
 M_1 &= \frac{M_2 r_2^2}{r_1^2} && \text{Divide by } r_1^2, \text{ assume } r_1 \neq 0
 \end{aligned}$$

As the reader may expect, checking the answer amounts to a good exercise in simplifying rational and radical expressions. The fact that we are assuming all of the variables represent positive real numbers comes in to play, as well.

¹¹Why is that again?

¹²including a Greek letter, no less!

9. Our last equation to solve comes from Einstein's Special Theory of Relativity and relates the mass of an object to its velocity as it moves.¹³ We are asked to solve for v which is located in just one term, namely v^2 , which happens to lie in a fraction underneath a square root which is itself a denominator. We have quite a lot of work ahead of us!

$$\begin{aligned}
 m &= \frac{m_0}{\sqrt{1 - \frac{v^2}{c^2}}} \\
 m\sqrt{1 - \frac{v^2}{c^2}} &= m_0 && \text{Multiply by } \sqrt{1 - \frac{v^2}{c^2}} \text{ to clear fractions} \\
 \left(m\sqrt{1 - \frac{v^2}{c^2}}\right)^2 &= m_0^2 && \text{Square both sides} \\
 m^2\left(1 - \frac{v^2}{c^2}\right) &= m_0^2 && \text{Properties of Exponents} \\
 m^2 - \frac{m^2v^2}{c^2} &= m_0^2 && \text{Distribute} \\
 -\frac{m^2v^2}{c^2} &= m_0^2 - m^2 && \text{Subtract } m^2 \\
 m^2v^2 &= -c^2(m_0^2 - m^2) && \text{Multiply by } -c^2 \text{ (} c^2 \neq 0 \text{)} \\
 m^2v^2 &= -c^2m_0^2 + c^2m^2 && \text{Distribute} \\
 v^2 &= \frac{c^2m^2 - c^2m_0^2}{m^2} && \text{Rearrange terms, divide by } m^2 \text{ (} m^2 \neq 0 \text{)} \\
 v &= \sqrt{\frac{c^2m^2 - c^2m_0^2}{m^2}} && \text{Extract Square Roots, } v > 0 \text{ so no } \pm \\
 v &= \frac{\sqrt{c^2(m^2 - m_0^2)}}{\sqrt{m^2}} && \text{Properties of Radicals, factor} \\
 v &= \frac{|c|\sqrt{m^2 - m_0^2}}{|m|} \\
 v &= \frac{c\sqrt{m^2 - m_0^2}}{m} && c > 0 \text{ and } m > 0 \text{ so } |c| = c \text{ and } |m| = m
 \end{aligned}$$

Checking the answer algebraically would earn the reader great honor and respect on the Algebra battlefield so it is highly recommended.

0.9.1 RATIONALIZING DENOMINATORS AND NUMERATORS

In Section 0.7, there were a few instances where we needed to 'rationalize' a denominator - that is, take a fraction with radical in the denominator and re-write it as an equivalent fraction without a

¹³See this article on the [Lorentz Factor](#).

radical in the denominator. There are various reasons for wanting to do this,¹⁴ but the most pressing reason is that rationalizing denominators - and numerators as well - gives us an opportunity for more practice with fractions and radicals. To help refresh your memory, we rationalize a denominator and then a numerator below:

$$\frac{1}{\sqrt{2}} = \frac{\sqrt{2}}{\sqrt{2}\sqrt{2}} = \frac{\sqrt{2}}{\sqrt{4}} = \frac{\sqrt{2}}{2} \quad \text{and} \quad \frac{7\sqrt[3]{4}}{3} = \frac{7\sqrt[3]{4}\sqrt[3]{2}}{3\sqrt[3]{2}} = \frac{7\sqrt[3]{8}}{3\sqrt[3]{2}} = \frac{7 \cdot 2}{3\sqrt[3]{2}} = \frac{14}{3\sqrt[3]{2}}$$

In general, if the fraction contains either a single term numerator or denominator with an undesirable n^{th} root, we multiply the numerator and denominator by whatever is required to obtain a perfect n^{th} power in the radicand that we want to eliminate. If the fraction contains two terms the situation is somewhat more complicated. To see why, consider the fraction $\frac{3}{4-\sqrt{5}}$. Suppose we wanted to rid the denominator of the $\sqrt{5}$ term. We could try as above and multiply numerator and denominator by $\sqrt{5}$ but that just yields:

$$\frac{3}{4-\sqrt{5}} = \frac{3\sqrt{5}}{(4-\sqrt{5})\sqrt{5}} = \frac{3\sqrt{5}}{4\sqrt{5}-\sqrt{5}\sqrt{5}} = \frac{3\sqrt{5}}{4\sqrt{5}-5}$$

We haven't removed $\sqrt{5}$ from the denominator - we've just shuffled it over to the other term in the denominator. As you may recall, the strategy here is to multiply both numerator and denominator by what's called the **conjugate**.

Definition 0.17. Conjugate of a Square Root Expression: If a , b and c are real numbers with $c > 0$ then the quantities $(a + b\sqrt{c})$ and $(a - b\sqrt{c})$ are **conjugates** of one another.^a Conjugates multiply according to the Difference of Squares Formula:

$$(a + b\sqrt{c})(a - b\sqrt{c}) = a^2 - (b\sqrt{c})^2 = a^2 - b^2c$$

^aAs are $(b\sqrt{c} - a)$ and $(b\sqrt{c} + a)$: $(b\sqrt{c} - a)(b\sqrt{c} + a) = b^2c - a^2$.

That is, to get the conjugate of a two-term expression involving a square root, you change the ‘-’ to a ‘+,’ or vice-versa. For example, the conjugate of $4 - \sqrt{5}$ is $4 + \sqrt{5}$, and when we multiply these two factors together, we get $(4 - \sqrt{5})(4 + \sqrt{5}) = 4^2 - (\sqrt{5})^2 = 16 - 5 = 11$. Hence, to eliminate the $\sqrt{5}$ from the denominator of our original fraction, we multiply both the numerator and denominator by the *conjugate* of $4 - \sqrt{5}$:

$$\frac{3}{4-\sqrt{5}} = \frac{3(4+\sqrt{5})}{(4-\sqrt{5})(4+\sqrt{5})} = \frac{3(4+\sqrt{5})}{4^2-(\sqrt{5})^2} = \frac{3(4+\sqrt{5})}{16-5} = \frac{12+3\sqrt{5}}{11}$$

What if we had $\sqrt[3]{5}$ instead of $\sqrt{5}$? We could try multiplying $4 - \sqrt[3]{5}$ by $4 + \sqrt[3]{5}$ to get

$$(4 - \sqrt[3]{5})(4 + \sqrt[3]{5}) = 4^2 - (\sqrt[3]{5})^2 = 16 - \sqrt[3]{25},$$

¹⁴Before the advent of the handheld calculator, rationalizing denominators made it easier to get decimal approximations to fractions containing radicals. However, some (admittedly more abstract) applications remain today - one of which you'll see in Calculus.

which leaves us with a cube root. What we need to undo the cube root is a perfect cube, which means we look to the Difference of Cubes Formula for inspiration: $a^3 - b^3 = (a - b)(a^2 + ab + b^2)$. If we take $a = 4$ and $b = \sqrt[3]{5}$, we multiply

$$(4 - \sqrt[3]{5})(4^2 + 4\sqrt[3]{5} + (\sqrt[3]{5})^2) = 4^3 + 4^2\sqrt[3]{5} + 4\sqrt[3]{5} - 4^2\sqrt[3]{5} - 4(\sqrt[3]{5})^2 - (\sqrt[3]{5})^3 = 64 - 5 = 59$$

So if we were charged with rationalizing the denominator of $\frac{3}{4 - \sqrt[3]{5}}$, we'd have:

$$\frac{3}{4 - \sqrt[3]{5}} = \frac{3(4^2 + 4\sqrt[3]{5} + (\sqrt[3]{5})^2)}{(4 - \sqrt[3]{5})(4^2 + 4\sqrt[3]{5} + (\sqrt[3]{5})^2)} = \frac{48 + 12\sqrt[3]{5} + 3\sqrt[3]{25}}{59}$$

This sort of thing extends to n^{th} roots since $(a - b)$ is a factor of $a^n - b^n$ for all natural numbers n , but in practice, we'll stick with square roots with just a few cube roots thrown in for a challenge.¹⁵

Example 0.9.3. Rationalize the indicated numerator or denominator:

1. Rationalize the denominator: $\frac{3}{\sqrt[5]{24x^2}}$
2. Rationalize the numerator: $\frac{\sqrt{9+h} - 3}{h}$

Solution.

1. We are asked to rationalize the denominator, which in this case contains a fifth root. That means we need to work to create fifth powers of each of the factors of the radicand. To do so, we first factor the radicand: $24x^2 = 8 \cdot 3 \cdot x^2 = 2^3 \cdot 3 \cdot x^2$. To obtain fifth powers, we need to multiply by $2^2 \cdot 3^4 \cdot x^3$ inside the radical.

$$\begin{aligned} \frac{3}{\sqrt[5]{24x^2}} &= \frac{3}{\sqrt[5]{2^3 \cdot 3 \cdot x^2}} \\ &= \frac{3\sqrt[5]{2^2 \cdot 3^4 \cdot x^3}}{\sqrt[5]{2^3 \cdot 3 \cdot x^2} \sqrt[5]{2^2 \cdot 3^4 \cdot x^3}} && \text{Equivalent Fractions} \\ &= \frac{3\sqrt[5]{2^2 \cdot 3^4 \cdot x^3}}{\sqrt[5]{2^3 \cdot 3 \cdot x^2 \cdot 2^2 \cdot 3^4 \cdot x^3}} && \text{Product Rule} \\ &= \frac{3\sqrt[5]{2^2 \cdot 3^4 \cdot x^3}}{\sqrt[5]{2^5 \cdot 3^5 \cdot x^5}} && \text{Property of Exponents} \\ &= \frac{3\sqrt[5]{2^2 \cdot 3^4 \cdot x^3}}{\sqrt[5]{2^5} \sqrt[5]{3^5} \sqrt[5]{x^5}} && \text{Product Rule} \\ &= \frac{3\sqrt[5]{2^2 \cdot 3^4 \cdot x^3}}{2 \cdot 3 \cdot x} && \text{Product Rule} \\ &= \frac{\cancel{3}\sqrt[5]{4 \cdot 81 \cdot x^3}}{2 \cdot \cancel{3} \cdot x} && \text{Reduce} \\ &= \frac{\sqrt[5]{324x^3}}{2x} && \text{Simplify} \end{aligned}$$

¹⁵To see what to do about fourth roots, use long division to find $(a^4 - b^4) \div (a - b)$, and apply this to $4 - \sqrt[4]{5}$.

2. Here, we are asked to rationalize the *numerator*. Since it is a two term numerator involving a square root, we multiply both numerator and denominator by the conjugate of $\sqrt{9+h}-3$, namely $\sqrt{9+h}+3$. After simplifying, we find an opportunity to reduce the fraction:

$$\begin{aligned}
 \frac{\sqrt{9+h}-3}{h} &= \frac{(\sqrt{9+h}-3)(\sqrt{9+h}+3)}{h(\sqrt{9+h}+3)} && \text{Equivalent Fractions} \\
 &= \frac{(\sqrt{9+h})^2-3^2}{h(\sqrt{9+h}+3)} && \text{Difference of Squares} \\
 &= \frac{(9+h)-9}{h(\sqrt{9+h}+3)} && \text{Simplify} \\
 &= \frac{h}{h(\sqrt{9+h}+3)} && \text{Simplify} \\
 &= \frac{\cancel{h}^1}{\cancel{h}(\sqrt{9+h}+3)} && \text{Reduce} \\
 &= \frac{1}{\sqrt{9+h}+3}
 \end{aligned}$$

We close this section with an awesome example from Calculus.

Example 0.9.4. Simplify the compound fraction $\frac{\frac{1}{\sqrt{2(x+h)+1}} - \frac{1}{\sqrt{2x+1}}}{h}$ then rationalize the numerator of the result.

Solution. We start by multiplying the top and bottom of the ‘big’ fraction by $\sqrt{2x+2h+1}\sqrt{2x+1}$.

$$\begin{aligned}
 \frac{\frac{1}{\sqrt{2(x+h)+1}} - \frac{1}{\sqrt{2x+1}}}{h} &= \frac{\frac{1}{\sqrt{2x+2h+1}} - \frac{1}{\sqrt{2x+1}}}{h} \\
 &= \frac{\left(\frac{1}{\sqrt{2x+2h+1}} - \frac{1}{\sqrt{2x+1}}\right)\sqrt{2x+2h+1}\sqrt{2x+1}}{h\sqrt{2x+2h+1}\sqrt{2x+1}} \\
 &= \frac{\frac{\sqrt{2x+2h+1}\sqrt{2x+1}}{\sqrt{2x+2h+1}} - \frac{\sqrt{2x+2h+1}\sqrt{2x+1}}{\sqrt{2x+1}}}{h\sqrt{2x+2h+1}\sqrt{2x+1}} \\
 &= \frac{\sqrt{2x+1} - \sqrt{2x+2h+1}}{h\sqrt{2x+2h+1}\sqrt{2x+1}}
 \end{aligned}$$

Next, we multiply the numerator and denominator by the conjugate of $\sqrt{2x+1} - \sqrt{2x+2h+1}$,

namely $\sqrt{2x+1} + \sqrt{2x+2h+1}$, simplify and reduce:

$$\begin{aligned}
 \frac{\sqrt{2x+1} - \sqrt{2x+2h+1}}{h\sqrt{2x+2h+1}\sqrt{2x+1}} &= \frac{(\sqrt{2x+1} - \sqrt{2x+2h+1})(\sqrt{2x+1} + \sqrt{2x+2h+1})}{h\sqrt{2x+2h+1}\sqrt{2x+1}(\sqrt{2x+1} + \sqrt{2x+2h+1})} \\
 &= \frac{(\sqrt{2x+1})^2 - (\sqrt{2x+2h+1})^2}{h\sqrt{2x+2h+1}\sqrt{2x+1}(\sqrt{2x+1} + \sqrt{2x+2h+1})} \\
 &= \frac{(2x+1) - (2x+2h+1)}{h\sqrt{2x+2h+1}\sqrt{2x+1}(\sqrt{2x+1} + \sqrt{2x+2h+1})} \\
 &= \frac{2x+1 - 2x - 2h - 1}{h\sqrt{2x+2h+1}\sqrt{2x+1}(\sqrt{2x+1} + \sqrt{2x+2h+1})} \\
 &= \frac{-2h}{h\sqrt{2x+2h+1}\sqrt{2x+1}(\sqrt{2x+1} + \sqrt{2x+2h+1})} \\
 &= \frac{-2}{\sqrt{2x+2h+1}\sqrt{2x+1}(\sqrt{2x+1} + \sqrt{2x+2h+1})}
 \end{aligned}$$

While the denominator is quite a bit more complicated than what we started with, we have done what was asked of us. In the interest of full disclosure, the reason we did all of this was to cancel the original 'h' from the denominator. That's an awful lot of effort to get rid of just one little h , but you'll see the significance of this in Calculus. \square

0.9.2 EXERCISES

In Exercises 1 - 13, perform the indicated operations and simplify.

1. $\sqrt{9x^2}$

2. $\sqrt[3]{8t^3}$

3. $\sqrt{50y^6}$

4. $\sqrt{4t^2 + 4t + 1}$

5. $\sqrt{w^2 - 16w + 64}$

6. $\sqrt{(\sqrt{12x} - \sqrt{3x})^2 + 1}$

7. $\sqrt{\frac{c^2 - v^2}{c^2}}$

8. $\sqrt[3]{\frac{24\pi r^5}{L^3}}$

9. $\sqrt[4]{\frac{32\pi\epsilon^8}{\rho^{12}}}$

10. $\sqrt{x} - \frac{x+1}{\sqrt{x}}$

11. $3\sqrt{1-t^2} + 3t\left(\frac{1}{2\sqrt{1-t^2}}\right)(-2t)$

12. $2\sqrt[3]{1-z} + 2z\left(\frac{1}{3(\sqrt[3]{1-z})^2}\right)(-1)$

13. $\frac{3}{\sqrt[3]{2x-1}} + (3x)\left(-\frac{1}{3(\sqrt[3]{2x-1})^4}\right)(2)$

In Exercises 14 - 25, find all real solutions.

14. $(2x+1)^3 + 8 = 0$

15. $\frac{(1-2y)^4}{3} = 27$

16. $\frac{1}{1+2t^3} = 4$

17. $\sqrt{3x+1} = 4$

18. $5 - \sqrt[3]{t^2+1} = 1$

19. $x+1 = \sqrt{3x+7}$

20. $y + \sqrt{3y+10} = -2$

21. $3t + \sqrt{6-9t} = 2$

22. $2x-1 = \sqrt{x+3}$

23. $w = \sqrt[4]{12-w^2}$

24. $\sqrt{x-2} + \sqrt{x-5} = 3$

25. $\sqrt{2x+1} = 3 + \sqrt{4-x}$

In Exercises 26 - 29, solve each equation for the indicated variable. Assume all quantities represent positive real numbers.

26. Solve for h : $I = \frac{bh^3}{12}$.

27. Solve for a : $I_0 = \frac{5\sqrt{3}a^4}{16}$

28. Solve for g : $T = 2\pi\sqrt{\frac{L}{g}}$

29. Solve for v : $L = L_0\sqrt{1 - \frac{v^2}{c^2}}$.

In Exercises 30 - 35, rationalize the numerator or denominator, and simplify.

30. $\frac{4}{3-\sqrt{2}}$

31. $\frac{7}{\sqrt[3]{12x^7}}$

32. $\frac{\sqrt{x}-\sqrt{c}}{x-c}$

33. $\frac{\sqrt{2x+2h+1}-\sqrt{2x+1}}{h}$

34. $\frac{\sqrt[3]{x+1}-2}{x-7}$

35. $\frac{\sqrt[3]{x+h}-\sqrt[3]{x}}{h}$

0.9.3 ANSWERS

1. $3|x|$

2. $2t$

3. $5|y^3|\sqrt{2}$

4. $|2t + 1|$

5. $|w - 8|$

6. $\sqrt{3x + 1}$

7. $\frac{\sqrt{c^2 - v^2}}{|c|}$

8. $\frac{2r\sqrt[3]{3\pi r^2}}{L}$

9. $\frac{2\varepsilon^2\sqrt[4]{2\pi}}{|\rho^3|}$

10. $-\frac{1}{\sqrt{x}}$

11. $\frac{3 - 6t^2}{\sqrt{1 - t^2}}$

12. $\frac{6 - 8z}{3(\sqrt[3]{1 - z})^2}$

13. $\frac{4x - 3}{(2x - 1)\sqrt[3]{2x - 1}}$

14. $x = -\frac{3}{2}$

15. $y = -1, 2$

16. $t = -\frac{\sqrt[3]{3}}{2}$

17. $x = 5$

18. $t = \pm 3\sqrt{7}$

19. $x = 3$

20. $y = -3$

21. $t = -\frac{1}{3}, \frac{2}{3}$

22. $x = \frac{5 + \sqrt{57}}{8}$

23. $w = \sqrt{3}$

24. $x = 6$

25. $x = 4$

26. $h = \sqrt[3]{\frac{12I}{b}}$

27. $a = \frac{2\sqrt[4]{I_0}}{\sqrt[4]{5\sqrt{3}}}$

28. $g = \frac{4\pi^2 L}{T^2}$

29. $v = \frac{c\sqrt{L_0^2 - L^2}}{L_0}$

30. $\frac{12 + 4\sqrt{2}}{7}$

31. $\frac{7\sqrt[3]{18x^2}}{6x^3}$

32. $\frac{1}{\sqrt{x} + \sqrt{c}}$

33. $\frac{2}{\sqrt{2x + 2h + 1} + \sqrt{2x + 1}}$

34. $\frac{1}{(\sqrt[3]{x + 1})^2 + 2\sqrt[3]{x + 1} + 4}$

35. $\frac{1}{(\sqrt[3]{x + h})^2 + \sqrt[3]{x + h}\sqrt[3]{x} + (\sqrt[3]{x})^2}$

0.10 CIRCLES

Recall from Geometry that a circle can be determined by fixing a point (called the center) and a positive number (called the radius) as follows.

Definition 0.18. A **circle** with center (h, k) and radius $r > 0$ is the set of all points (x, y) in the plane whose distance to (h, k) is r .

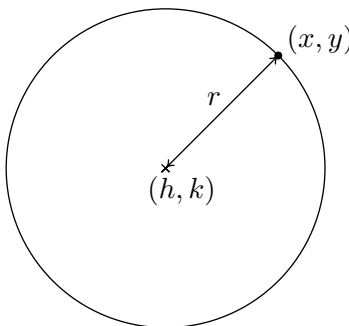

From the picture, we see that a point (x, y) is on the circle if and only if its distance to (h, k) is r . We express this relationship algebraically using the Distance Formula, Equation 1.1, as

$$r = \sqrt{(x - h)^2 + (y - k)^2}$$

By squaring both sides of this equation, we get an equivalent equation (since $r > 0$) which gives us the standard equation of a circle.

Equation 0.1. The Standard Equation of a Circle: The equation of a circle with center (h, k) and radius $r > 0$ is $(x - h)^2 + (y - k)^2 = r^2$.

Example 0.10.1. Write the standard equation of the circle with center $(-2, 3)$ and radius 5.

Solution. Here, $(h, k) = (-2, 3)$ and $r = 5$, so we get

$$\begin{aligned} (x - (-2))^2 + (y - 3)^2 &= (5)^2 \\ (x + 2)^2 + (y - 3)^2 &= 25 \end{aligned}$$

□

Example 0.10.2. Graph $(x + 2)^2 + (y - 1)^2 = 4$. Find the center and radius.

Solution. From the standard form of a circle, Equation 0.1, we have that $x + 2$ is $x - h$, so $h = -2$ and $y - 1$ is $y - k$ so $k = 1$. This tells us that our center is $(-2, 1)$. Furthermore, $r^2 = 4$, so $r = 2$. Thus we have a circle centered at $(-2, 1)$ with a radius of 2. Graphing gives us

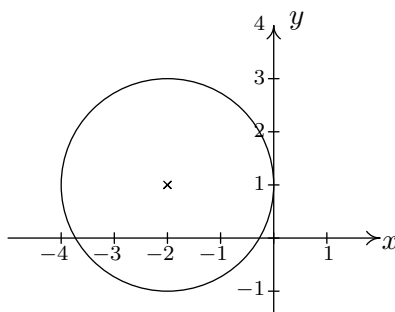

□

If we were to expand the equation in the previous example and gather up like terms, instead of the easily recognizable $(x + 2)^2 + (y - 1)^2 = 4$, we'd be contending with $x^2 + 4x + y^2 - 2y + 1 = 0$. If we're given such an equation, we can complete the square in each of the variables to see if it fits the form given in Equation 0.1 by following the steps given below.

To Write the Equation of a Circle in Standard Form

1. Group the same variables together on one side of the equation and position the constant on the other side.
2. Complete the square on both variables as needed.
3. Divide both sides by the coefficient of the squares. (For circles, they will be the same.)

Example 0.10.3. Complete the square to find the center and radius of $3x^2 - 6x + 3y^2 + 4y - 4 = 0$.

Solution.

$$\begin{aligned}
 3x^2 - 6x + 3y^2 + 4y - 4 &= 0 \\
 3x^2 - 6x + 3y^2 + 4y &= 4 && \text{add 4 to both sides} \\
 3(x^2 - 2x) + 3\left(y^2 + \frac{4}{3}y\right) &= 4 && \text{factor out leading coefficients} \\
 3(x^2 - 2x + \underline{1}) + 3\left(y^2 + \frac{4}{3}y + \underline{\frac{4}{9}}\right) &= 4 + 3(\underline{1}) + 3\left(\underline{\frac{4}{9}}\right) && \text{complete the square in } x, y \\
 3(x - 1)^2 + 3\left(y + \frac{2}{3}\right)^2 &= \frac{25}{3} && \text{factor} \\
 (x - 1)^2 + \left(y + \frac{2}{3}\right)^2 &= \frac{25}{9} && \text{divide both sides by 3}
 \end{aligned}$$

From Equation 0.1, we identify $x - 1$ as $x - h$, so $h = 1$, and $y + \frac{2}{3}$ as $y - k$, so $k = -\frac{2}{3}$. Hence, the center is $(h, k) = (1, -\frac{2}{3})$. Furthermore, we see that $r^2 = \frac{25}{9}$ so the radius is $r = \frac{5}{3}$. □

It is possible to obtain equations like $(x - 3)^2 + (y + 1)^2 = 0$ or $(x - 3)^2 + (y + 1)^2 = -1$, neither of which describes a circle. (Do you see why not?) The reader is encouraged to think about what, if any, points lie on the graphs of these two equations. The next example uses the Midpoint Formula, Equation 1.2, in conjunction with the ideas presented so far in this section.

Example 0.10.4. Write the standard equation of the circle which has $(-1, 3)$ and $(2, 4)$ as the endpoints of a diameter.

Solution. We recall that a diameter of a circle is a line segment containing the center and two points on the circle. Plotting the given data yields

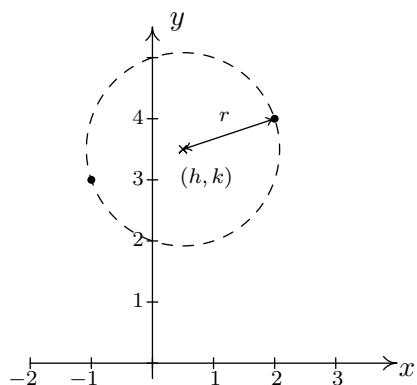

Since the given points are endpoints of a diameter, we know their midpoint (h, k) is the center of the circle. Equation 1.2 gives us

$$\begin{aligned} (h, k) &= \left(\frac{x_1 + x_2}{2}, \frac{y_1 + y_2}{2} \right) \\ &= \left(\frac{-1 + 2}{2}, \frac{3 + 4}{2} \right) \\ &= \left(\frac{1}{2}, \frac{7}{2} \right) \end{aligned}$$

The diameter of the circle is the distance between the given points, so we know that half of the distance is the radius. Thus,

$$\begin{aligned} r &= \frac{1}{2} \sqrt{(x_2 - x_1)^2 + (y_2 - y_1)^2} \\ &= \frac{1}{2} \sqrt{(2 - (-1))^2 + (4 - 3)^2} \\ &= \frac{1}{2} \sqrt{3^2 + 1^2} \\ &= \frac{\sqrt{10}}{2} \end{aligned}$$

Finally, since $\left(\frac{\sqrt{10}}{2}\right)^2 = \frac{10}{4}$, our answer becomes $\left(x - \frac{1}{2}\right)^2 + \left(y - \frac{7}{2}\right)^2 = \frac{10}{4}$ □

We close this section with the most important¹ circle in all of mathematics: the **Unit Circle**.

Definition 0.19. The **Unit Circle** is the circle centered at $(0, 0)$ with a radius of 1. The standard equation of the Unit Circle is $x^2 + y^2 = 1$.

Example 0.10.5. Find the points on the unit circle with y -coordinate $\frac{\sqrt{3}}{2}$.

Solution. We replace y with $\frac{\sqrt{3}}{2}$ in the equation $x^2 + y^2 = 1$ to get

$$\begin{aligned} x^2 + y^2 &= 1 \\ x^2 + \left(\frac{\sqrt{3}}{2}\right)^2 &= 1 \\ \frac{3}{4} + x^2 &= 1 \\ x^2 &= \frac{1}{4} \\ x &= \pm\sqrt{\frac{1}{4}} \\ x &= \pm\frac{1}{2} \end{aligned}$$

Our final answers are $\left(\frac{1}{2}, \frac{\sqrt{3}}{2}\right)$ and $\left(-\frac{1}{2}, \frac{\sqrt{3}}{2}\right)$. □

¹While this may seem like an opinion, it is indeed a fact. See Chapters 8 and 9 for details.

0.10.1 EXERCISES

In Exercises 1 - 6, find the standard equation of the circle and then graph it.

- | | |
|---|--|
| 1. Center $(-1, -5)$, radius 10 | 2. Center $(4, -2)$, radius 3 |
| 3. Center $(-3, \frac{7}{13})$, radius $\frac{1}{2}$ | 4. Center $(5, -9)$, radius $\ln(8)$ |
| 5. Center $(-e, \sqrt{2})$, radius π | 6. Center (π, e^2) , radius $\sqrt[3]{91}$ |

In Exercises 7 - 12, complete the square in order to put the equation into standard form. Identify the center and the radius or explain why the equation does not represent a circle.

- | | |
|-----------------------------------|--|
| 7. $x^2 - 4x + y^2 + 10y = -25$ | 8. $-2x^2 - 36x - 2y^2 - 112 = 0$ |
| 9. $x^2 + y^2 + 8x - 10y - 1 = 0$ | 10. $x^2 + y^2 + 5x - y - 1 = 0$ |
| 11. $4x^2 + 4y^2 - 24y + 36 = 0$ | 12. $x^2 + x + y^2 - \frac{6}{5}y = 1$ |

In Exercises 13 - 16, find the standard equation of the circle which satisfies the given criteria.

- | | |
|---|---|
| 13. center $(3, 5)$, passes through $(-1, -2)$ | 14. center $(3, 6)$, passes through $(-1, 4)$ |
| 15. endpoints of a diameter: $(3, 6)$ and $(-1, 4)$ | 16. endpoints of a diameter: $(\frac{1}{2}, 4)$, $(\frac{3}{2}, -1)$ |
17. The Giant Wheel at Cedar Point is a circle with diameter 128 feet which sits on an 8 foot tall platform making its overall height is 136 feet.² Find an equation for the wheel assuming that its center lies on the y -axis and that the ground is the x -axis.
18. Verify that the following points lie on the Unit Circle: $(\pm 1, 0)$, $(0, \pm 1)$, $(\pm \frac{\sqrt{2}}{2}, \pm \frac{\sqrt{2}}{2})$, $(\pm \frac{1}{2}, \pm \frac{\sqrt{3}}{2})$ and $(\pm \frac{\sqrt{3}}{2}, \pm \frac{1}{2})$
19. Discuss with your classmates how to obtain the standard equation of a circle, Equation 0.1, from the equation of the Unit Circle, $x^2 + y^2 = 1$ using the transformations discussed in Section 1.7. (Thus every circle is just a few transformations away from the Unit Circle.)
20. Find an equation for the function represented graphically by the top half of the Unit Circle. Explain how the transformations in Section 1.7 can be used to produce a function whose graph is either the top or bottom of an arbitrary circle.
21. Find a one-to-one function whose graph is half of a circle. (Hint: Think piecewise.)

²Source: [Cedar Point's webpage](#).

0.10.2 ANSWERS

1. $(x + 1)^2 + (y + 5)^2 = 100$

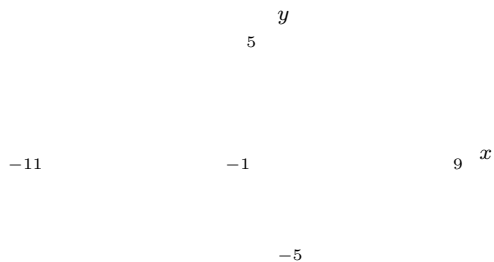

2. $(x - 4)^2 + (y + 2)^2 = 9$

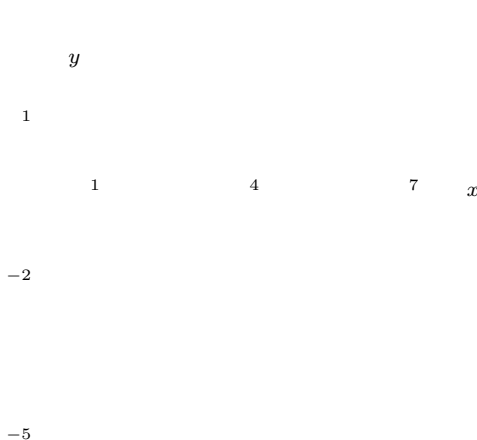

Circles.4

Circles.5

3. $(x + 3)^2 + (y - \frac{7}{13})^2 = \frac{1}{4}$

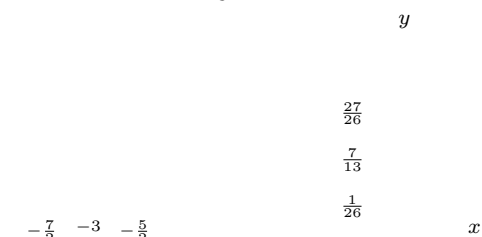

4. $(x - 5)^2 + (y + 9)^2 = (\ln(8))^2$

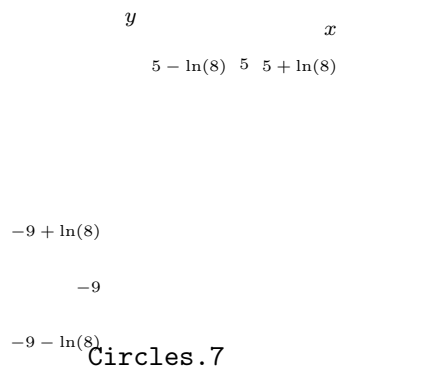

Circles.6

Circles.7

5. $(x + e)^2 + (y - \sqrt{2})^2 = \pi^2$

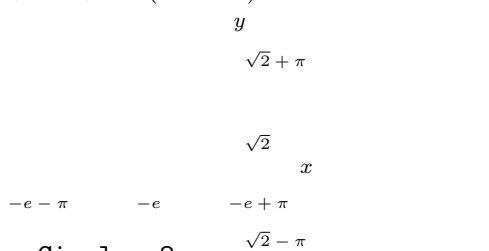

6. $(x - \pi)^2 + (y - e^2)^2 = 91^{\frac{2}{3}}$

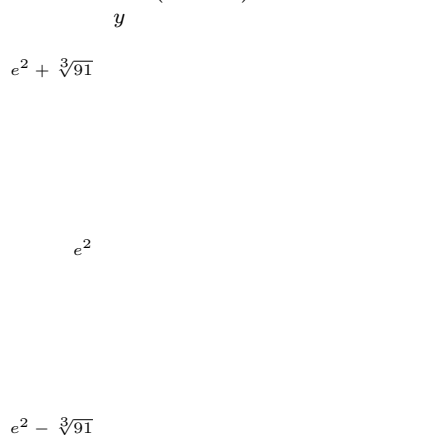

Circles.8

Circles.9

7. $(x - 2)^2 + (y + 5)^2 = 4$

Center $(2, -5)$, radius $r = 2$

9. $(x + 4)^2 + (y - 5)^2 = 42$

Center $(-4, 5)$, radius $r = \sqrt{42}$

11. $x^2 + (y - 3)^2 = 0$

This is not a circle.

13. $(x - 3)^2 + (y - 5)^2 = 65$

15. $(x - 1)^2 + (y - 5)^2 = 5$

17. $x^2 + (y - 72)^2 = 4096$

8. $(x + 9)^2 + y^2 = 25$

Center $(-9, 0)$, radius $r = 5$

10. $(x + \frac{5}{2})^2 + (y - \frac{1}{2})^2 = \frac{30}{4}$

Center $(-\frac{5}{2}, \frac{1}{2})$, radius $r = \frac{\sqrt{30}}{2}$

12. $(x + \frac{1}{2})^2 + (y - \frac{3}{5})^2 = \frac{161}{100}$

Center $(-\frac{1}{2}, \frac{3}{5})$, radius $r = \frac{\sqrt{161}}{10}$

14. $(x - 3)^2 + (y - 6)^2 = 20$

16. $(x - 1)^2 + (y - \frac{3}{2})^2 = \frac{13}{2}$

CHAPTER 1

RELATIONS AND FUNCTIONS

1.1 SETS OF REAL NUMBERS AND THE CARTESIAN COORDINATE PLANE

1.1.1 SETS OF NUMBERS

While the authors would like nothing more than to delve quickly and deeply into the sheer excitement that is *Precalculus*, experience¹ has taught us that a brief refresher on some basic notions is welcome, if not completely necessary, at this stage. To that end, we present a brief summary of ‘set theory’ and some of the associated vocabulary and notations we use in the text. Like all good Math books, we begin with a definition.

Definition 1.1. A **set** is a well-defined collection of objects which are called the ‘elements’ of the set. Here, ‘well-defined’ means that it is possible to determine if something belongs to the collection or not, without prejudice.

For example, the collection of letters that make up the word “smolko” is well-defined and is a set, but the collection of the worst math teachers in the world is **not** well-defined, and so is **not** a set.² In general, there are three ways to describe sets. They are

Ways to Describe Sets

1. **The Verbal Method:** Use a sentence to define a set.
2. **The Roster Method:** Begin with a left brace ‘{’, list each element of the set *only once* and then end with a right brace ‘}’.
3. **The Set-Builder Method:** A combination of the verbal and roster methods using a “dummy variable” such as x .

For example, let S be the set described *verbally* as the set of letters that make up the word “smolko”. A **roster** description of S would be $\{s, m, o, l, k\}$. Note that we listed ‘o’ only once, even though it

¹...to be read as ‘good, solid feedback from colleagues’ ...

²For a more thought-provoking example, consider the collection of all things that do not contain themselves - this leads to the famous [Russell’s Paradox](#).

appears twice in “smolko.” Also, the *order* of the elements doesn’t matter, so $\{k, l, m, o, s\}$ is also a roster description of S . A **set-builder** description of S is:

$$\{x \mid x \text{ is a letter in the word “smolko”}.\}$$

The way to read this is: ‘The set of elements x such that x is a letter in the word “smolko.”’ In each of the above cases, we may use the familiar equals sign ‘=’ and write $S = \{s, m, o, l, k\}$ or $S = \{x \mid x \text{ is a letter in the word “smolko”}.\}$. Clearly m is in S and q is not in S . We express these sentiments mathematically by writing $m \in S$ and $q \notin S$. Throughout your mathematical upbringing, you have encountered several famous sets of numbers. They are listed below.

Sets of Numbers

1. The **Empty Set**: $\emptyset = \{\} = \{x \mid x \neq x\}$. This is the set with no elements. Like the number ‘0,’ it plays a vital role in mathematics.^a
2. The **Natural Numbers**: $\mathbb{N} = \{1, 2, 3, \dots\}$ The periods of ellipsis here indicate that the natural numbers contain 1, 2, 3, ‘and so forth’.
3. The **Whole Numbers**: $\mathbb{W} = \{0, 1, 2, \dots\}$
4. The **Integers**: $\mathbb{Z} = \{\dots, -3, -2, -1, 0, 1, 2, 3, \dots\}$
5. The **Rational Numbers**: $\mathbb{Q} = \{\frac{a}{b} \mid a \in \mathbb{Z} \text{ and } b \in \mathbb{Z}\}$. Rational numbers are the ratios of integers (provided the denominator is not zero!) It turns out that another way to describe the rational numbers is:

$$\mathbb{Q} = \{x \mid x \text{ possesses a repeating or terminating decimal representation.}\}$$

6. The **Real Numbers**: $\mathbb{R} = \{x \mid x \text{ possesses a decimal representation.}\}$
7. The **Irrational Numbers**: $\mathbb{P} = \{x \mid x \text{ is a non-rational real number.}\}$ Said another way, an irrational number is a decimal which neither repeats nor terminates.^b
8. The **Complex Numbers**: $\mathbb{C} = \{a + bi \mid a, b \in \mathbb{R} \text{ and } i = \sqrt{-1}\}$ Despite their importance, the complex numbers play only a minor role in the text.^c

^a... which, sadly, we will not explore in this text.

^bThe classic example is the number π (See Section 8.1), but numbers like $\sqrt{2}$ and $0.101001000100001\dots$ are other fine representatives.

^cThey first appear in Section 3.4.





It is important to note that every natural number is a whole number, which, in turn, is an integer. Each integer is a rational number (take $b = 1$ in the above definition for \mathbb{Q}) and the rational numbers are all real numbers, since they possess decimal representations.³ If we take $b = 0$ in the above definition of \mathbb{C} , we see that every real number is a complex number. In this sense, the sets \mathbb{N} , \mathbb{W} , \mathbb{Z} , \mathbb{Q} , \mathbb{R} , and \mathbb{C} are ‘nested’ like [Matryoshka dolls](#).

³Long division, anyone?

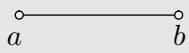
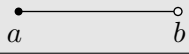
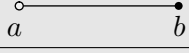
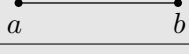
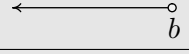

For the most part, this textbook focuses on sets whose elements come from the real numbers \mathbb{R} . Recall that we may visualize \mathbb{R} as a line. Segments of this line are called **intervals** of numbers. Below is a summary of the so-called **interval notation** associated with given sets of numbers. For intervals with finite endpoints, we list the left endpoint, then the right endpoint. We use square brackets, '[' or ']', if the endpoint is included in the interval and use a filled-in or 'closed' dot to indicate membership in the interval. Otherwise, we use parentheses, '(' or ')', and an 'open' circle to indicate that the endpoint is not part of the set. If the interval does not have finite endpoints, we use the symbols $-\infty$ to indicate that the interval extends indefinitely to the left and ∞ to indicate that the interval extends indefinitely to the right. Since infinity is a concept, and not a number, we always use parentheses when using these symbols in interval notation, and use an appropriate arrow to indicate that the interval extends indefinitely in one (or both) directions.

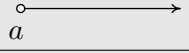
Interval Notation

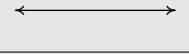
Let a and b be real numbers with $a < b$.

Set of Real Numbers	Interval Notation	Region on the Real Number Line
$\{x \mid a < x < b\}$	(a, b)	
$\{x \mid a \leq x < b\}$	$[a, b)$	
$\{x \mid a < x \leq b\}$	$(a, b]$	
$\{x \mid a \leq x \leq b\}$	$[a, b]$	
$\{x \mid x < b\}$	$(-\infty, b)$	
$\{x \mid x \leq b\}$	$(-\infty, b]$	
$\{x \mid x > a\}$	(a, ∞)	
$\{x \mid x \geq a\}$	$[a, \infty)$	
\mathbb{R}	$(-\infty, \infty)$	

For an example, consider the sets of real numbers described below.

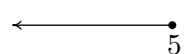
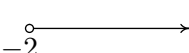
Set of Real Numbers	Interval Notation	Region on the Real Number Line
$\{x \mid 1 \leq x < 3\}$	$[1, 3)$	
$\{x \mid -1 \leq x \leq 4\}$	$[-1, 4]$	
$\{x \mid x \leq 5\}$	$(-\infty, 5]$	
$\{x \mid x > -2\}$	$(-2, \infty)$	

We will often have occasion to combine sets. There are two basic ways to combine sets: **intersection** and **union**. We define both of these concepts below.

Definition 1.2. Suppose A and B are two sets.

- The **intersection** of A and B : $A \cap B = \{x \mid x \in A \text{ and } x \in B\}$
- The **union** of A and B : $A \cup B = \{x \mid x \in A \text{ or } x \in B \text{ (or both)}\}$

Said differently, the intersection of two sets is the overlap of the two sets – the elements which the sets have in common. The union of two sets consists of the totality of the elements in each of the sets, collected together.⁴ For example, if $A = \{1, 2, 3\}$ and $B = \{2, 4, 6\}$, then $A \cap B = \{2\}$ and $A \cup B = \{1, 2, 3, 4, 6\}$. If $A = [-5, 3)$ and $B = (1, \infty)$, then we can find $A \cap B$ and $A \cup B$ graphically. To find $A \cap B$, we shade the overlap of the two and obtain $A \cap B = (1, 3)$. To find $A \cup B$, we shade each of A and B and describe the resulting shaded region to find $A \cup B = [-5, \infty)$.

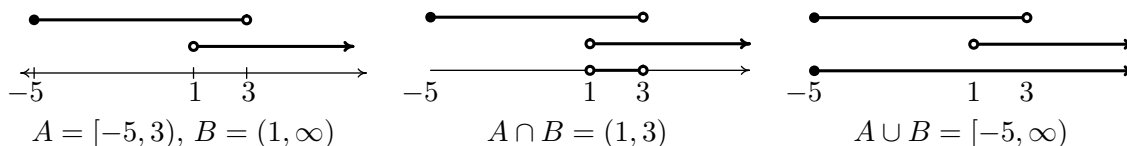

While both intersection and union are important, we have more occasion to use union in this text than intersection, simply because most of the sets of real numbers we will be working with are either intervals or are unions of intervals, as the following example illustrates.

⁴The reader is encouraged to research [Venn Diagrams](#) for a nice geometric interpretation of these concepts.

Example 1.1.1. Express the following sets of numbers using interval notation.

1. $\{x \mid x \leq -2 \text{ or } x \geq 2\}$
2. $\{x \mid x \neq 3\}$
3. $\{x \mid x \neq \pm 3\}$
4. $\{x \mid -1 < x \leq 3 \text{ or } x = 5\}$

Solution.

1. The best way to proceed here is to graph the set of numbers on the number line and glean the answer from it. The inequality $x \leq -2$ corresponds to the interval $(-\infty, -2]$ and the inequality $x \geq 2$ corresponds to the interval $[2, \infty)$. Since we are looking to describe the real numbers x in one of these *or* the other, we have $\{x \mid x \leq -2 \text{ or } x \geq 2\} = (-\infty, -2] \cup [2, \infty)$.

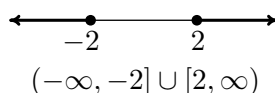

2. For the set $\{x \mid x \neq 3\}$, we shade the entire real number line except $x = 3$, where we leave an open circle. This divides the real number line into two intervals, $(-\infty, 3)$ and $(3, \infty)$. Since the values of x could be in either one of these intervals *or* the other, we have that $\{x \mid x \neq 3\} = (-\infty, 3) \cup (3, \infty)$

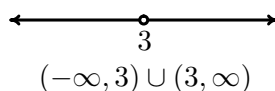

3. For the set $\{x \mid x \neq \pm 3\}$, we proceed as before and exclude both $x = 3$ and $x = -3$ from our set. This breaks the number line into *three* intervals, $(-\infty, -3)$, $(-3, 3)$ and $(3, \infty)$. Since the set describes real numbers which come from the first, second *or* third interval, we have $\{x \mid x \neq \pm 3\} = (-\infty, -3) \cup (-3, 3) \cup (3, \infty)$.

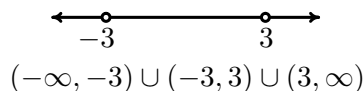

4. Graphing the set $\{x \mid -1 < x \leq 3 \text{ or } x = 5\}$, we get one interval, $(-1, 3]$ along with a single number, or point, $\{5\}$. While we *could* express the latter as $[5, 5]$ (Can you see why?), we choose to write our answer as $\{x \mid -1 < x \leq 3 \text{ or } x = 5\} = (-1, 3] \cup \{5\}$.

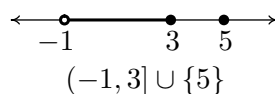

□

1.1.2 THE CARTESIAN COORDINATE PLANE

In order to visualize the pure excitement that is Precalculus, we need to unite Algebra and Geometry. Simply put, we must find a way to draw algebraic things. Let's start with possibly the greatest mathematical achievement of all time: the **Cartesian Coordinate Plane**.⁵ Imagine two real number lines crossing at a right angle at 0 as drawn below.

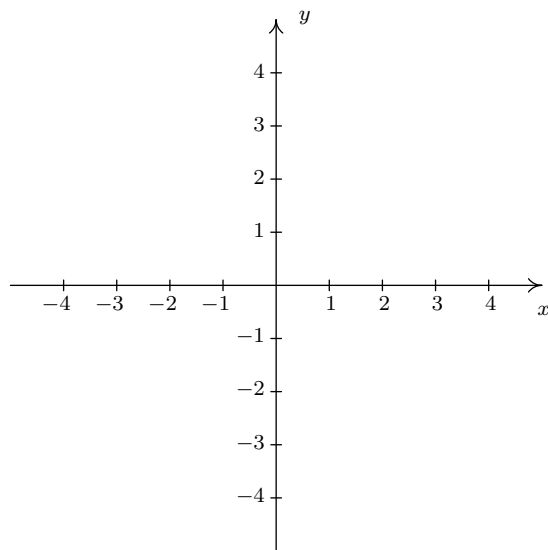

The horizontal number line is usually called the **x -axis** while the vertical number line is usually called the **y -axis**.⁶ As with the usual number line, we imagine these axes extending off indefinitely in both directions.⁷ Having two number lines allows us to locate the positions of points off of the number lines as well as points on the lines themselves.

For example, consider the point P on the next page. To use the numbers on the axes to label this point, we imagine dropping a vertical line from the x -axis to P and extending a horizontal line from the y -axis to P . This process is sometimes called ‘projecting’ the point P to the x - (respectively y -) axis. We then describe the point P using the **ordered pair** $(2, -4)$. The first number in the ordered pair is called the **abscissa** or **x -coordinate** and the second is called the **ordinate** or **y -coordinate**.⁸ Taken together, the ordered pair $(2, -4)$ comprise the **Cartesian coordinates**⁹ of the point P . In practice, the distinction between a point and its coordinates is blurred; for example, we often speak of ‘the point $(2, -4)$.’ We can think of $(2, -4)$ as instructions on how to

⁵So named in honor of [René Descartes](#).

⁶The labels can vary depending on the context of application.

⁷Usually extending off towards infinity is indicated by arrows, but here, the arrows are used to indicate the *direction* of increasing values of x and y .

⁸Again, the names of the coordinates can vary depending on the context of the application. If, for example, the horizontal axis represented time we might choose to call it the t -axis. The first number in the ordered pair would then be the t -coordinate.

⁹Also called the ‘rectangular coordinates’ of P – see Section 9.3 for more details.

reach P from the **origin** $(0,0)$ by moving 2 units to the right and 4 units downwards. Notice that the order in the ordered pair is important – if we wish to plot the point $(-4,2)$, we would move to the left 4 units from the origin and then move upwards 2 units, as below on the right.

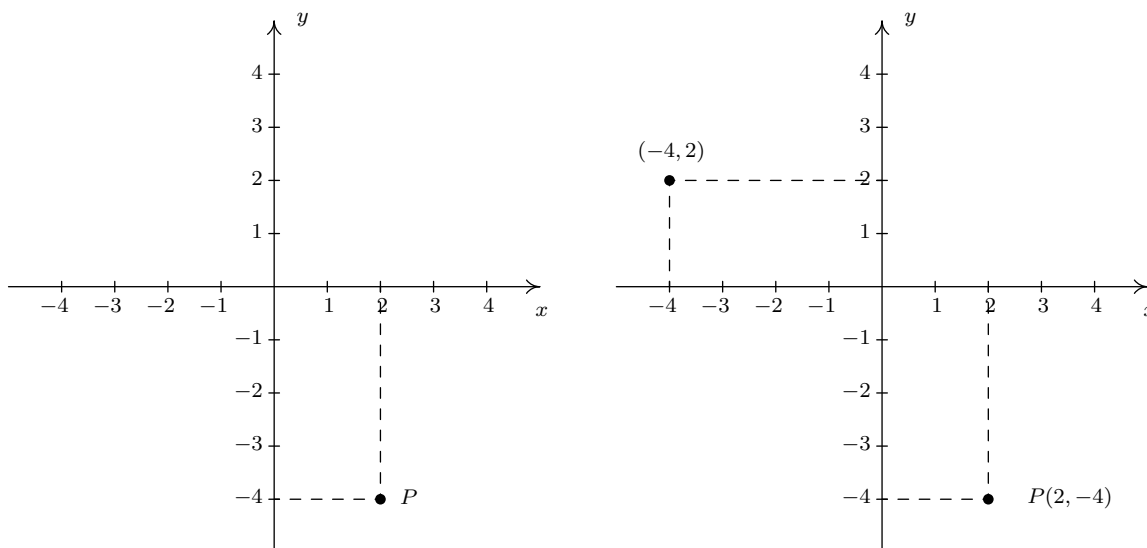

When we speak of the Cartesian Coordinate Plane, we mean the set of all possible ordered pairs (x, y) as x and y take values from the real numbers. Below is a summary of important facts about Cartesian coordinates.

Important Facts about the Cartesian Coordinate Plane

- (a, b) and (c, d) represent the same point in the plane if and only if $a = c$ and $b = d$.
- (x, y) lies on the x -axis if and only if $y = 0$.
- (x, y) lies on the y -axis if and only if $x = 0$.
- The origin is the point $(0, 0)$. It is the only point common to both axes.

Example 1.1.2. Plot the following points: $A(5, 8)$, $B(-\frac{5}{2}, 3)$, $C(-5.8, -3)$, $D(4.5, -1)$, $E(5, 0)$, $F(0, 5)$, $G(-7, 0)$, $H(0, -9)$, $O(0, 0)$.¹⁰

Solution. To plot these points, we start at the origin and move to the right if the x -coordinate is positive; to the left if it is negative. Next, we move up if the y -coordinate is positive or down if it is negative. If the x -coordinate is 0, we start at the origin and move along the y -axis only. If the y -coordinate is 0 we move along the x -axis only.

¹⁰The letter O is almost always reserved for the origin.

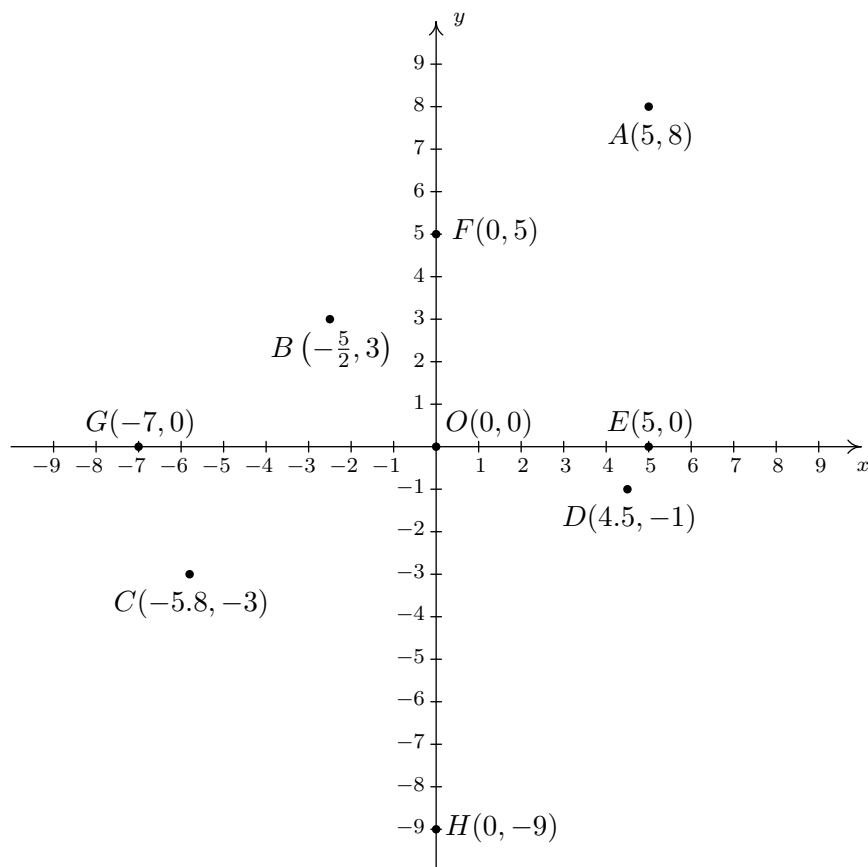

□

The axes divide the plane into four regions called **quadrants**. They are labeled with Roman numerals and proceed counterclockwise around the plane:

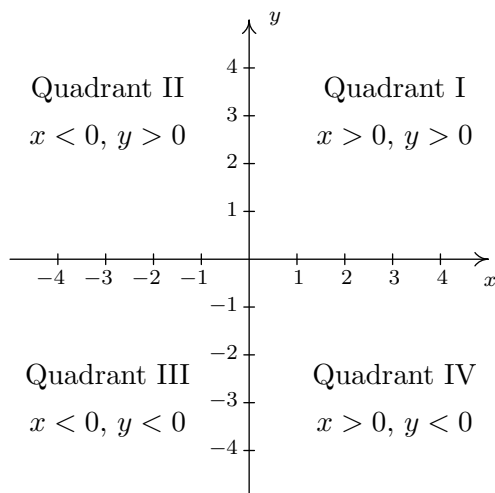

For example, $(1, 2)$ lies in Quadrant I, $(-1, 2)$ in Quadrant II, $(-1, -2)$ in Quadrant III and $(1, -2)$ in Quadrant IV. If a point other than the origin happens to lie on the axes, we typically refer to that point as lying on the positive or negative x -axis (if $y = 0$) or on the positive or negative y -axis (if $x = 0$). For example, $(0, 4)$ lies on the positive y -axis whereas $(-117, 0)$ lies on the negative x -axis. Such points do not belong to any of the four quadrants.

One of the most important concepts in all of Mathematics is **symmetry**.¹¹ There are many types of symmetry in Mathematics, but three of them can be discussed easily using Cartesian Coordinates.

Definition 1.3. Two points (a, b) and (c, d) in the plane are said to be

- **symmetric about the x -axis** if $a = c$ and $b = -d$
- **symmetric about the y -axis** if $a = -c$ and $b = d$
- **symmetric about the origin** if $a = -c$ and $b = -d$

Schematically,

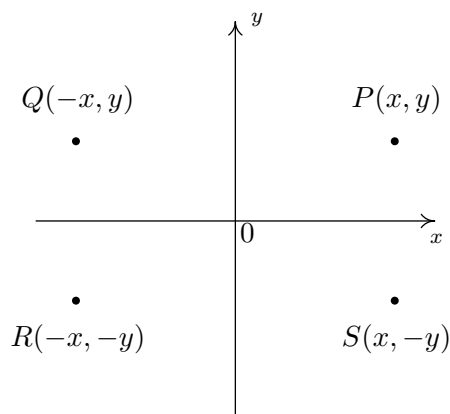

In the above figure, P and S are symmetric about the x -axis, as are Q and R ; P and Q are symmetric about the y -axis, as are R and S ; and P and R are symmetric about the origin, as are Q and S .

Example 1.1.3. Let P be the point $(-2, 3)$. Find the points which are symmetric to P about the:

1. x -axis
2. y -axis
3. origin

Check your answer by plotting the points.

Solution. The figure after Definition 1.3 gives us a good way to think about finding symmetric points in terms of taking the opposites of the x - and/or y -coordinates of $P(-2, 3)$.

¹¹According to Carl. Jeff thinks symmetry is overrated.

1. To find the point symmetric about the x -axis, we replace the y -coordinate with its opposite to get $(-2, -3)$.
2. To find the point symmetric about the y -axis, we replace the x -coordinate with its opposite to get $(2, 3)$.
3. To find the point symmetric about the origin, we replace the x - and y -coordinates with their opposites to get $(2, -3)$.

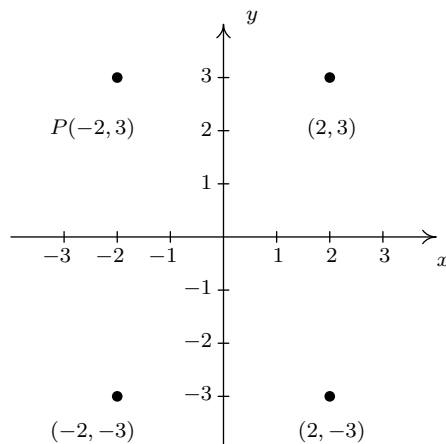

□

One way to visualize the processes in the previous example is with the concept of a **reflection**. If we start with our point $(-2, 3)$ and pretend that the x -axis is a mirror, then the reflection of $(-2, 3)$ across the x -axis would lie at $(-2, -3)$. If we pretend that the y -axis is a mirror, the reflection of $(-2, 3)$ across that axis would be $(2, 3)$. If we reflect across the x -axis and then the y -axis, we would go from $(-2, 3)$ to $(-2, -3)$ then to $(2, -3)$, and so we would end up at the point symmetric to $(-2, 3)$ about the origin. We summarize and generalize this process below.

Reflections

To reflect a point (x, y) about the:

- x -axis, replace y with $-y$.
- y -axis, replace x with $-x$.
- origin, replace x with $-x$ and y with $-y$.

1.1.3 DISTANCE IN THE PLANE

Another important concept in Geometry is the notion of length. If we are going to unite Algebra and Geometry using the Cartesian Plane, then we need to develop an algebraic understanding of what distance in the plane means. Suppose we have two points, $P(x_0, y_0)$ and $Q(x_1, y_1)$, in the plane. By the **distance** d between P and Q , we mean the length of the line segment joining P with Q . (Remember, given any two distinct points in the plane, there is a unique line containing both

points.) Our goal now is to create an algebraic formula to compute the distance between these two points. Consider the generic situation below on the left.

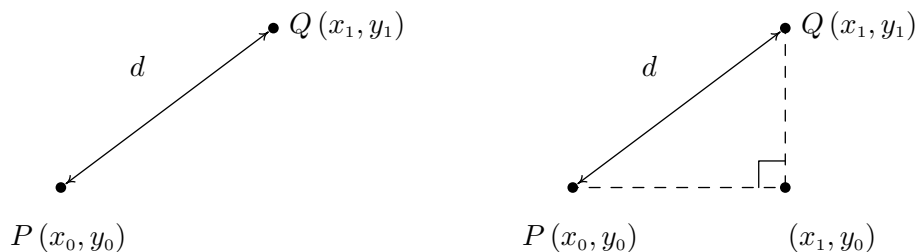

With a little more imagination, we can envision a right triangle whose hypotenuse has length d as drawn above on the right. From the latter figure, we see that the lengths of the legs of the triangle are $|x_1 - x_0|$ and $|y_1 - y_0|$ so the [Pythagorean Theorem](#) gives us

$$\begin{aligned} |x_1 - x_0|^2 + |y_1 - y_0|^2 &= d^2 \\ (x_1 - x_0)^2 + (y_1 - y_0)^2 &= d^2 \end{aligned}$$

(Do you remember why we can replace the absolute value notation with parentheses?) By extracting the square root of both sides of the second equation and using the fact that distance is never negative, we get

Equation 1.1. The Distance Formula: The distance d between the points $P(x_0, y_0)$ and $Q(x_1, y_1)$ is:

$$d = \sqrt{(x_1 - x_0)^2 + (y_1 - y_0)^2}$$

It is not always the case that the points P and Q lend themselves to constructing such a triangle. If the points P and Q are arranged vertically or horizontally, or describe the exact same point, we cannot use the above geometric argument to derive the distance formula. It is left to the reader in [Exercise 35](#) to verify [Equation 1.1](#) for these cases.

Example 1.1.4. Find and simplify the distance between $P(-2, 3)$ and $Q(1, -3)$.

Solution.

$$\begin{aligned} d &= \sqrt{(x_1 - x_0)^2 + (y_1 - y_0)^2} \\ &= \sqrt{(1 - (-2))^2 + (-3 - 3)^2} \\ &= \sqrt{9 + 36} \\ &= 3\sqrt{5} \end{aligned}$$

So the distance is $3\sqrt{5}$. □

Example 1.1.5. Find all of the points with x -coordinate 1 which are 4 units from the point $(3, 2)$.

Solution. We shall soon see that the points we wish to find are on the line $x = 1$, but for now we'll just view them as points of the form $(1, y)$. Visually,

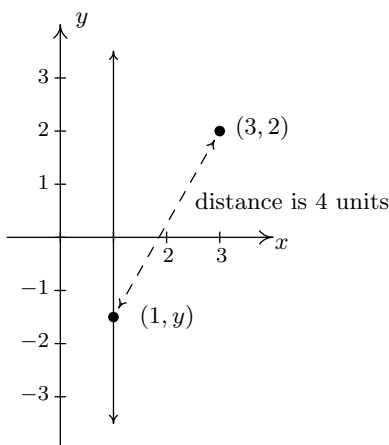

We require that the distance from $(3, 2)$ to $(1, y)$ be 4. The Distance Formula, Equation 1.1, yields

$$\begin{aligned}
 d &= \sqrt{(x_1 - x_0)^2 + (y_1 - y_0)^2} \\
 4 &= \sqrt{(1 - 3)^2 + (y - 2)^2} \\
 4 &= \sqrt{4 + (y - 2)^2} \\
 4^2 &= \left(\sqrt{4 + (y - 2)^2}\right)^2 && \text{squaring both sides} \\
 16 &= 4 + (y - 2)^2 \\
 12 &= (y - 2)^2 \\
 (y - 2)^2 &= 12 \\
 y - 2 &= \pm\sqrt{12} && \text{extracting the square root} \\
 y - 2 &= \pm 2\sqrt{3} \\
 y &= 2 \pm 2\sqrt{3}
 \end{aligned}$$

We obtain two answers: $(1, 2 + 2\sqrt{3})$ and $(1, 2 - 2\sqrt{3})$. The reader is encouraged to think about why there are two answers. □

Related to finding the distance between two points is the problem of finding the **midpoint** of the line segment connecting two points. Given two points, $P(x_0, y_0)$ and $Q(x_1, y_1)$, the **midpoint** M of P and Q is defined to be the point on the line segment connecting P and Q whose distance from P is equal to its distance from Q .

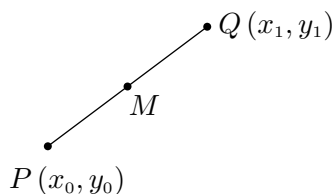

If we think of reaching M by going ‘halfway over’ and ‘halfway up’ we get the following formula.

Equation 1.2. The Midpoint Formula: The midpoint M of the line segment connecting $P(x_0, y_0)$ and $Q(x_1, y_1)$ is:

$$M = \left(\frac{x_0 + x_1}{2}, \frac{y_0 + y_1}{2} \right)$$

If we let d denote the distance between P and Q , we leave it as Exercise 36 to show that the distance between P and M is $d/2$ which is the same as the distance between M and Q . This suffices to show that Equation 1.2 gives the coordinates of the midpoint.

Example 1.1.6. Find the midpoint of the line segment connecting $P(-2, 3)$ and $Q(1, -3)$.

Solution.

$$\begin{aligned} M &= \left(\frac{x_0 + x_1}{2}, \frac{y_0 + y_1}{2} \right) \\ &= \left(\frac{(-2) + 1}{2}, \frac{3 + (-3)}{2} \right) = \left(-\frac{1}{2}, \frac{0}{2} \right) \\ &= \left(-\frac{1}{2}, 0 \right) \end{aligned}$$

The midpoint is $(-\frac{1}{2}, 0)$. □

We close with a more abstract application of the Midpoint Formula. We will revisit the following example in Exercise 72 in Section 2.1.

Example 1.1.7. If $a \neq b$, prove that the line $y = x$ equally divides the line segment with endpoints (a, b) and (b, a) .



Solution. To prove the claim, we use Equation 1.2 to find the midpoint

$$\begin{aligned} M &= \left(\frac{a + b}{2}, \frac{b + a}{2} \right) \\ &= \left(\frac{a + b}{2}, \frac{a + b}{2} \right) \end{aligned}$$

Since the x and y coordinates of this point are the same, we find that the midpoint lies on the line $y = x$, as required. □

1.1.4 EXERCISES

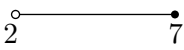
1. Fill in the chart below:

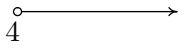
Set of Real Numbers	Interval Notation	Region on the Real Number Line
$\{x \mid -1 \leq x < 5\}$		
	$[0, 3)$	
		
$\{x \mid -5 < x \leq 0\}$		
	$(-3, 3)$	
		
$\{x \mid x \leq 3\}$		
	$(-\infty, 9)$	
		
$\{x \mid x \geq -3\}$		

In Exercises 2 - 7, find the indicated intersection or union and simplify if possible. Express your answers in interval notation.

2. $(-1, 5] \cap [0, 8)$

3. $(-1, 1) \cup [0, 6]$

4. $(-\infty, 4] \cap (0, \infty)$

5. $(-\infty, 0) \cap [1, 5]$

6. $(-\infty, 0) \cup [1, 5]$

7. $(-\infty, 5] \cap [5, 8)$

In Exercises 8 - 19, write the set using interval notation.

8. $\{x \mid x \neq 5\}$

9. $\{x \mid x \neq -1\}$

10. $\{x \mid x \neq -3, 4\}$

11. $\{x \mid x \neq 0, 2\}$ 12. $\{x \mid x \neq 2, -2\}$ 13. $\{x \mid x \neq 0, \pm 4\}$
14. $\{x \mid x \leq -1 \text{ or } x \geq 1\}$ 15. $\{x \mid x < 3 \text{ or } x \geq 2\}$ 16. $\{x \mid x \leq -3 \text{ or } x > 0\}$
17. $\{x \mid x \leq 5 \text{ or } x = 6\}$ 18. $\{x \mid x > 2 \text{ or } x = \pm 1\}$ 19. $\{x \mid -3 < x < 3 \text{ or } x = 4\}$
20. Plot and label the points $A(-3, -7)$, $B(1.3, -2)$, $C(\pi, \sqrt{10})$, $D(0, 8)$, $E(-5.5, 0)$, $F(-8, 4)$, $G(9.2, -7.8)$ and $H(7, 5)$ in the Cartesian Coordinate Plane given below.

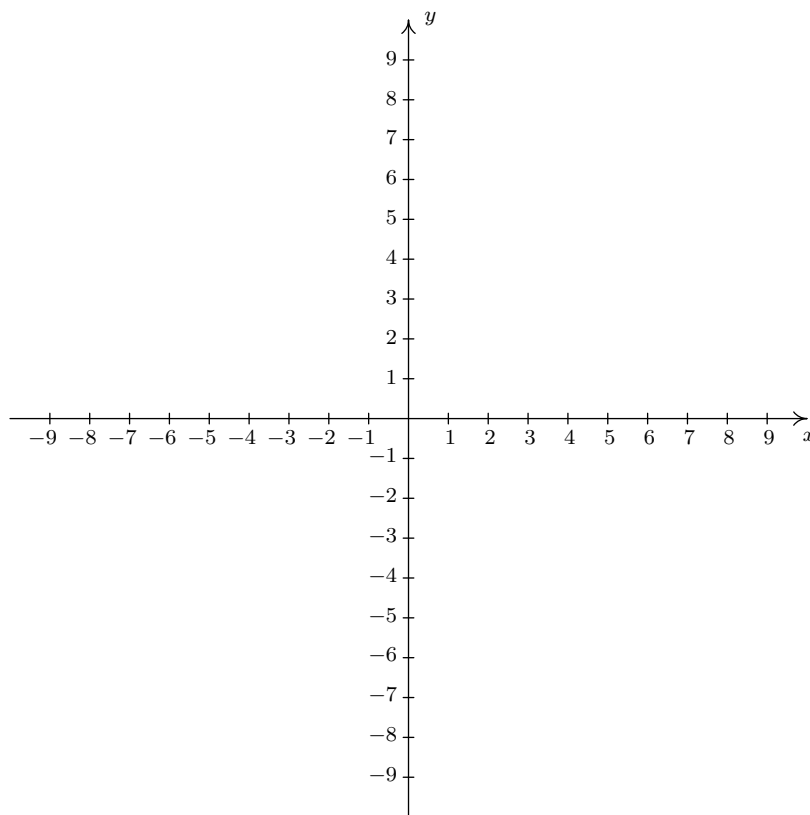

21. For each point given in Exercise 20 above
- Identify the quadrant or axis in/on which the point lies.
 - Find the point symmetric to the given point about the x -axis.
 - Find the point symmetric to the given point about the y -axis.
 - Find the point symmetric to the given point about the origin.

In Exercises 22 - 29, find the distance d between the points and the midpoint M of the line segment which connects them.

22. $(1, 2), (-3, 5)$

23. $(3, -10), (-1, 2)$

24. $\left(\frac{1}{2}, 4\right), \left(\frac{3}{2}, -1\right)$

25. $\left(-\frac{2}{3}, \frac{3}{2}\right), \left(\frac{7}{3}, 2\right)$

26. $\left(\frac{24}{5}, \frac{6}{5}\right), \left(-\frac{11}{5}, -\frac{19}{5}\right)$

27. $(\sqrt{2}, \sqrt{3}), (-\sqrt{8}, -\sqrt{12})$

28. $(2\sqrt{45}, \sqrt{12}), (\sqrt{20}, \sqrt{27})$

29. $(0, 0), (x, y)$

30. Find all of the points of the form $(x, -1)$ which are 4 units from the point $(3, 2)$.31. Find all of the points on the y -axis which are 5 units from the point $(-5, 3)$.32. Find all of the points on the x -axis which are 2 units from the point $(-1, 1)$.33. Find all of the points of the form $(x, -x)$ which are 1 unit from the origin.34. Let's assume for a moment that we are standing at the origin and the positive y -axis points due North while the positive x -axis points due East. Our Sasquatch-o-meter tells us that Sasquatch is 3 miles West and 4 miles South of our current position. What are the coordinates of his position? How far away is he from us? If he runs 7 miles due East what would his new position be?

35. Verify the Distance Formula 1.1 for the cases when:

(a) The points are arranged vertically. (Hint: Use $P(a, y_0)$ and $Q(a, y_1)$.)(b) The points are arranged horizontally. (Hint: Use $P(x_0, b)$ and $Q(x_1, b)$.)

(c) The points are actually the same point. (You shouldn't need a hint for this one.)

36. Verify the Midpoint Formula by showing the distance between $P(x_1, y_1)$ and M and the distance between M and $Q(x_2, y_2)$ are both half of the distance between P and Q .37. Show that the points A , B and C below are the vertices of a right triangle.

(a) $A(-3, 2)$, $B(-6, 4)$, and $C(1, 8)$







(b) $A(-3, 1)$, $B(4, 0)$ and $C(0, -3)$

38. Find a point $D(x, y)$ such that the points $A(-3, 1)$, $B(4, 0)$, $C(0, -3)$ and D are the corners of a square. Justify your answer.39. Discuss with your classmates how many numbers are in the interval $(0, 1)$.40. The world is not flat.¹² Thus the Cartesian Plane cannot possibly be the end of the story. Discuss with your classmates how you would extend Cartesian Coordinates to represent the three dimensional world. What would the Distance and Midpoint formulas look like, assuming those concepts make sense at all?

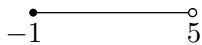
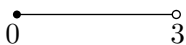
¹²There are those who disagree with this statement. Look them up on the Internet some time when you're bored.

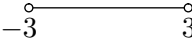
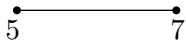
1.1.5 ANSWERS

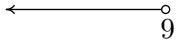
1.

Set of Real Numbers	Interval Notation	Region on the Real Number Line
$\{x \mid -1 \leq x < 5\}$	$[-1, 5)$	
$\{x \mid 0 \leq x < 3\}$	$[0, 3)$	
$\{x \mid 2 < x \leq 7\}$	$(2, 7]$	
$\{x \mid -5 < x \leq 0\}$	$(-5, 0]$	
$\{x \mid -3 < x < 3\}$	$(-3, 3)$	
$\{x \mid 5 \leq x \leq 7\}$	$[5, 7]$	
$\{x \mid x \leq 3\}$	$(-\infty, 3]$	
$\{x \mid x < 9\}$	$(-\infty, 9)$	
$\{x \mid x > 4\}$	$(4, \infty)$	
$\{x \mid x \geq -3\}$	$[-3, \infty)$	

2. $(-1, 5] \cap [0, 8) = [0, 5]$

3. $(-1, 1) \cup [0, 6] = (-1, 6]$

4. $(-\infty, 4] \cap (0, \infty) = (0, 4]$

5. $(-\infty, 0) \cap [1, 5] = \emptyset$

6. $(-\infty, 0) \cup [1, 5] = (-\infty, 0) \cup [1, 5]$

7. $(-\infty, 5] \cap [5, 8) = \{5\}$

8. $(-\infty, 5) \cup (5, \infty)$

9. $(-\infty, -1) \cup (-1, \infty)$

10. $(-\infty, -3) \cup (-3, 4) \cup (4, \infty)$

11. $(-\infty, 0) \cup (0, 2) \cup (2, \infty)$

12. $(-\infty, -2) \cup (-2, 2) \cup (2, \infty)$

13. $(-\infty, -4) \cup (-4, 0) \cup (0, 4) \cup (4, \infty)$

14. $(-\infty, -1] \cup [1, \infty)$

15. $(-\infty, \infty)$

16. $(-\infty, -3] \cup (0, \infty)$

17. $(-\infty, 5] \cup \{6\}$

18. $\{-1\} \cup \{1\} \cup (2, \infty)$

19. $(-3, 3) \cup \{4\}$

20. The required points $A(-3, -7)$, $B(1.3, -2)$, $C(\pi, \sqrt{10})$, $D(0, 8)$, $E(-5.5, 0)$, $F(-8, 4)$, $G(9.2, -7.8)$, and $H(7, 5)$ are plotted in the Cartesian Coordinate Plane below.

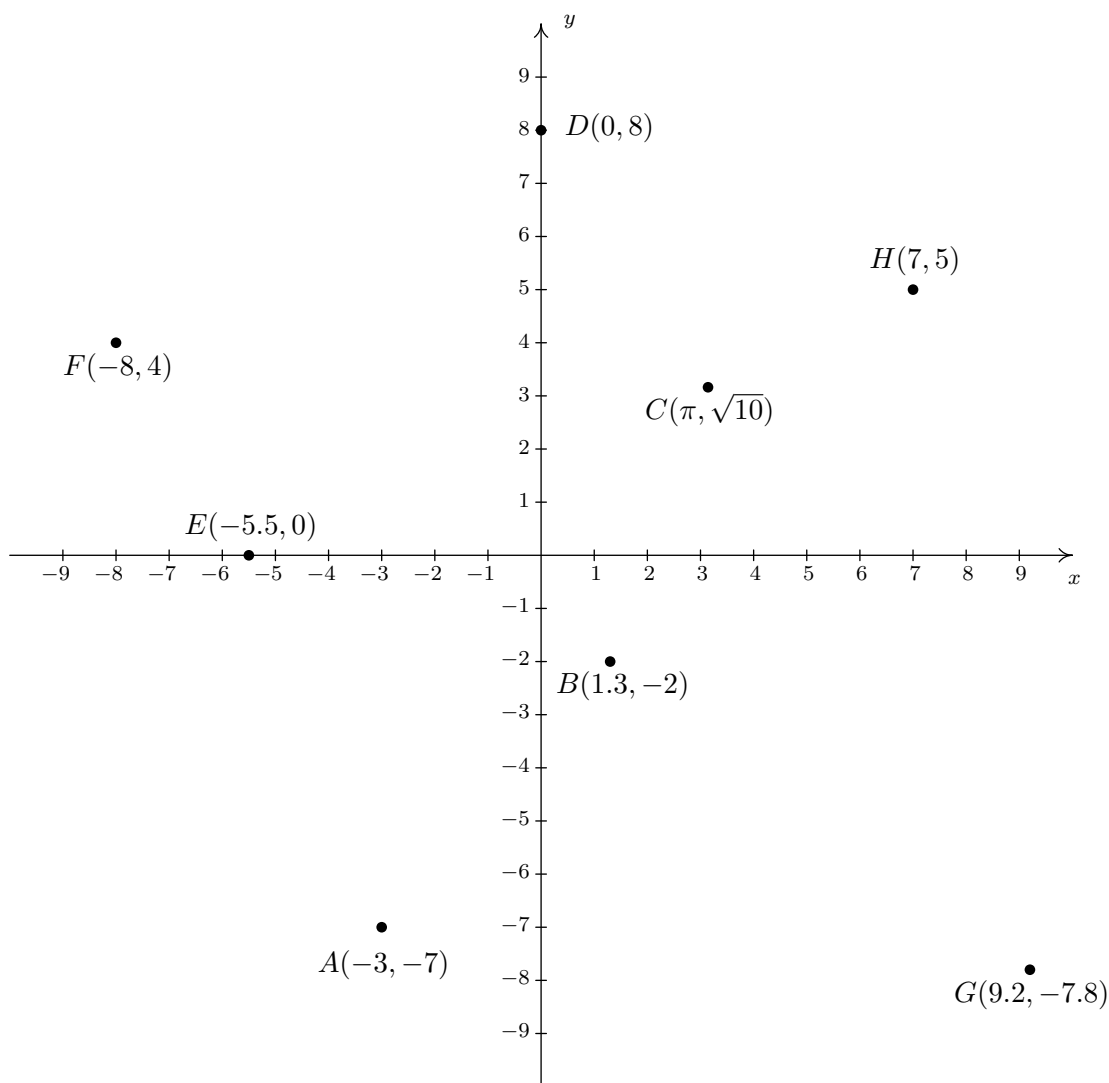

21. (a) The point $A(-3, -7)$ is
- in Quadrant III
 - symmetric about x -axis with $(-3, 7)$
 - symmetric about y -axis with $(3, -7)$
 - symmetric about origin with $(3, 7)$
- (b) The point $B(1.3, -2)$ is
- in Quadrant IV
 - symmetric about x -axis with $(1.3, 2)$
 - symmetric about y -axis with $(-1.3, -2)$
 - symmetric about origin with $(-1.3, 2)$
- (c) The point $C(\pi, \sqrt{10})$ is
- in Quadrant I
 - symmetric about x -axis with $(\pi, -\sqrt{10})$
 - symmetric about y -axis with $(-\pi, \sqrt{10})$
 - symmetric about origin with $(-\pi, -\sqrt{10})$
- (d) The point $D(0, 8)$ is
- on the positive y -axis
 - symmetric about x -axis with $(0, -8)$
 - symmetric about y -axis with $(0, 8)$
 - symmetric about origin with $(0, -8)$
- (e) The point $E(-5.5, 0)$ is
- on the negative x -axis
 - symmetric about x -axis with $(-5.5, 0)$
 - symmetric about y -axis with $(5.5, 0)$
 - symmetric about origin with $(5.5, 0)$
- (f) The point $F(-8, 4)$ is
- in Quadrant II
 - symmetric about x -axis with $(-8, -4)$
 - symmetric about y -axis with $(8, 4)$
 - symmetric about origin with $(8, -4)$
- (g) The point $G(9.2, -7.8)$ is
- in Quadrant IV
 - symmetric about x -axis with $(9.2, 7.8)$
 - symmetric about y -axis with $(-9.2, -7.8)$
 - symmetric about origin with $(-9.2, 7.8)$
- (h) The point $H(7, 5)$ is
- in Quadrant I
 - symmetric about x -axis with $(7, -5)$
 - symmetric about y -axis with $(-7, 5)$
 - symmetric about origin with $(-7, -5)$
22. $d = 5$, $M = (-1, \frac{7}{2})$
23. $d = 4\sqrt{10}$, $M = (1, -4)$
24. $d = \sqrt{26}$, $M = (1, \frac{3}{2})$
25. $d = \frac{\sqrt{37}}{2}$, $M = (\frac{5}{6}, \frac{7}{4})$
26. $d = \sqrt{74}$, $M = (\frac{13}{10}, -\frac{13}{10})$
27. $d = 3\sqrt{5}$, $M = (-\frac{\sqrt{2}}{2}, -\frac{\sqrt{3}}{2})$
28. $d = \sqrt{83}$, $M = (4\sqrt{5}, \frac{5\sqrt{3}}{2})$
29. $d = \sqrt{x^2 + y^2}$, $M = (\frac{x}{2}, \frac{y}{2})$
30. $(3 + \sqrt{7}, -1)$, $(3 - \sqrt{7}, -1)$
31. $(0, 3)$
32. $(-1 + \sqrt{3}, 0)$, $(-1 - \sqrt{3}, 0)$
33. $(\frac{\sqrt{2}}{2}, -\frac{\sqrt{2}}{2})$, $(-\frac{\sqrt{2}}{2}, \frac{\sqrt{2}}{2})$
34. $(-3, -4)$, 5 miles, $(4, -4)$
37. (a) The distance from A to B is $|AB| = \sqrt{13}$, the distance from A to C is $|AC| = \sqrt{52}$, and the distance from B to C is $|BC| = \sqrt{65}$. Since $(\sqrt{13})^2 + (\sqrt{52})^2 = (\sqrt{65})^2$, we are guaranteed by the [converse of the Pythagorean Theorem](#) that the triangle is a right triangle.
- (b) Show that $|AC|^2 + |BC|^2 = |AB|^2$

1.2 RELATIONS

From one point of view,¹ all of Precalculus can be thought of as studying sets of points in the plane. With the Cartesian Plane now fresh in our memory we can discuss those sets in more detail and as usual, we begin with a definition.

Definition 1.4. A **relation** is a set of points in the plane.

Since relations are sets, we can describe them using the techniques presented in Section 1.1.1. That is, we can describe a relation verbally, using the roster method, or using set-builder notation. Since the elements in a relation are points in the plane, we often try to describe the relation graphically or algebraically as well. Depending on the situation, one method may be easier or more convenient to use than another. As an example, consider the relation $R = \{(-2, 1), (4, 3), (0, -3)\}$. As written, R is described using the roster method. Since R consists of points in the plane, we follow our instinct and plot the points. Doing so produces the **graph** of R .

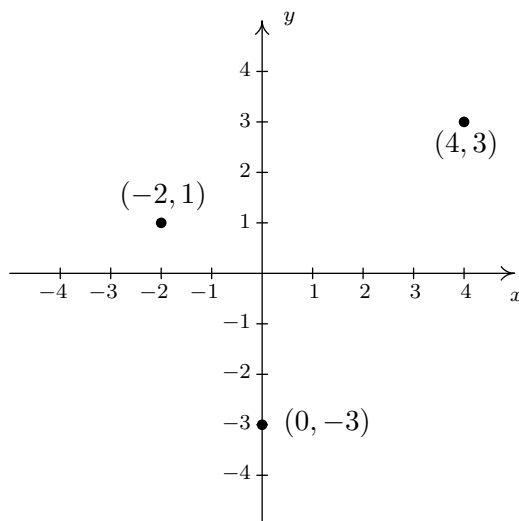

The graph of R .

In the following example, we graph a variety of relations.

Example 1.2.1. Graph the following relations.

1. $A = \{(0, 0), (-3, 1), (4, 2), (-3, 2)\}$
2. $HLS_1 = \{(x, 3) \mid -2 \leq x \leq 4\}$
3. $HLS_2 = \{(x, 3) \mid -2 \leq x < 4\}$
4. $V = \{(3, y) \mid y \text{ is a real number}\}$
5. $H = \{(x, y) \mid y = -2\}$
6. $R = \{(x, y) \mid 1 < y \leq 3\}$

¹Carl's, of course.

Solution.

- To graph A , we simply plot all of the points which belong to A , as shown below on the left.
- Don't let the notation in this part fool you. The name of this relation is HLS_1 , just like the name of the relation in number 1 was A . The letters and numbers are just part of its name, just like the numbers and letters of the phrase 'King George III' were part of George's name. In words, $\{(x, 3) \mid -2 \leq x \leq 4\}$ reads 'the set of points $(x, 3)$ such that $-2 \leq x \leq 4$.' All of these points have the same y -coordinate, 3, but the x -coordinate is allowed to vary between -2 and 4, inclusive. Some of the points which belong to HLS_1 include some friendly points like: $(-2, 3)$, $(-1, 3)$, $(0, 3)$, $(1, 3)$, $(2, 3)$, $(3, 3)$, and $(4, 3)$. However, HLS_1 also contains the points $(0.829, 3)$, $(-\frac{5}{6}, 3)$, $(\sqrt{\pi}, 3)$, and so on. It is impossible² to list all of these points, which is why the variable x is used. Plotting several friendly representative points should convince you that HLS_1 describes the horizontal line segment from the point $(-2, 3)$ up to and including the point $(4, 3)$.

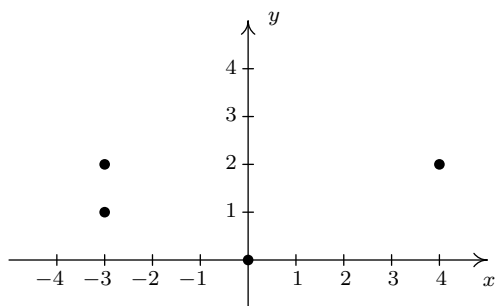
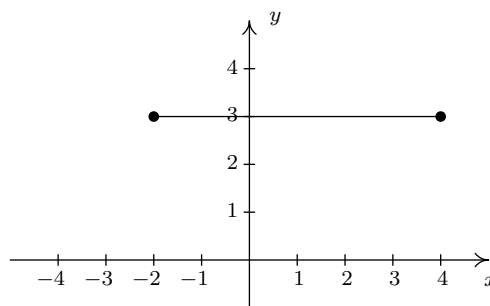
The graph of A The graph of HLS_1

- HLS_2 is hauntingly similar to HLS_1 . In fact, the only difference between the two is that instead of ' $-2 \leq x \leq 4$ ' we have ' $-2 \leq x < 4$ '. This means that we still get a horizontal line segment which includes $(-2, 3)$ and extends to $(4, 3)$, but we do *not* include $(4, 3)$ because of the strict inequality $x < 4$. How do we denote this on our graph? It is a common mistake to make the graph start at $(-2, 3)$ end at $(3, 3)$ as pictured below on the left. The problem with this graph is that we are forgetting about the points like $(3.1, 3)$, $(3.5, 3)$, $(3.9, 3)$, $(3.99, 3)$, and so forth. There is no real number that comes 'immediately before' 4, so to describe the set of points we want, we draw the horizontal line segment starting at $(-2, 3)$ and draw an open circle at $(4, 3)$ as depicted below on the right.

²Really impossible. The interested reader is encouraged to research [countable](#) versus [uncountable](#) sets.

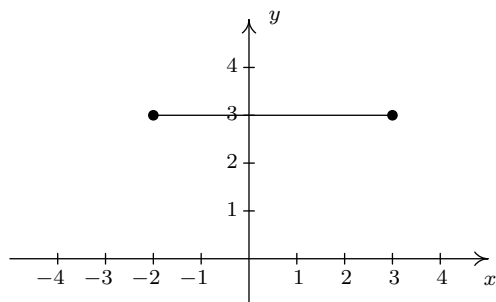
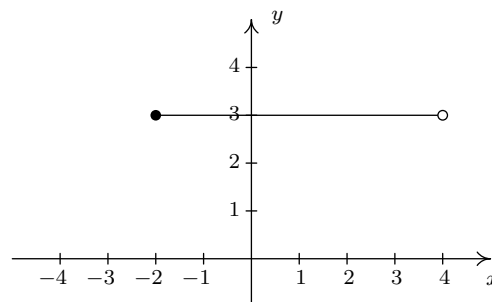
This is NOT the correct graph of HLS_2 The graph of HLS_2

4. Next, we come to the relation V , described as the set of points $(3, y)$ such that y is a real number. All of these points have an x -coordinate of 3, but the y -coordinate is free to be whatever it wants to be, without restriction.³ Plotting a few ‘friendly’ points of V should convince you that all the points of V lie on the vertical line⁴ $x = 3$. Since there is no restriction on the y -coordinate, we put arrows on the end of the portion of the line we draw to indicate it extends indefinitely in both directions. The graph of V is below on the left.
5. Though written slightly differently, the relation $H = \{(x, y) \mid y = -2\}$ is similar to the relation V above in that only one of the coordinates, in this case the y -coordinate, is specified, leaving x to be ‘free’. Plotting some representative points gives us the horizontal line $y = -2$.

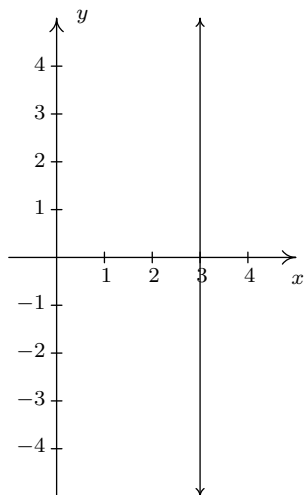
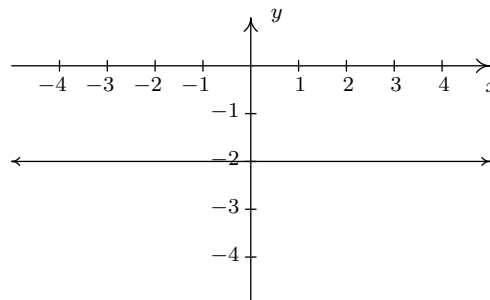
The graph of V The graph of H

6. For our last example, we turn to $R = \{(x, y) \mid 1 < y \leq 3\}$. As in the previous example, x is free to be whatever it likes. The value of y , on the other hand, while not completely free, is permitted to roam between 1 and 3 excluding 1, but including 3. After plotting some⁵ friendly elements of R , it should become clear that R consists of the region between the horizontal

³We’ll revisit the concept of a ‘free variable’ in Section 7.1.

⁴Don’t worry, we’ll be refreshing your memory about vertical and horizontal lines in just a moment!

⁵The word ‘some’ is a relative term. It may take 5, 10, or 50 points until you see the pattern.

lines $y = 1$ and $y = 3$. Since R requires that the y -coordinates be greater than 1, but not equal to 1, we dash the line $y = 1$ to indicate that those points do not belong to R .

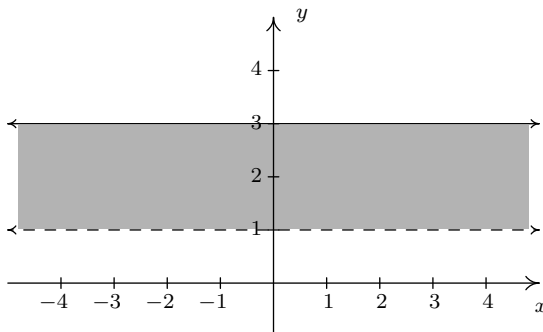

The graph of R

□

The relations V and H in the previous example lead us to our final way to describe relations: **algebraically**. We can more succinctly describe the points in V as those points which satisfy the equation ' $x = 3$ '. Most likely, you have seen equations like this before. Depending on the context, ' $x = 3$ ' could mean we have solved an equation for x and arrived at the solution $x = 3$. In this case, however, ' $x = 3$ ' describes a set of points in the plane whose x -coordinate is 3. Similarly, the relation H above can be described by the equation ' $y = -2$ '. At some point in your mathematical upbringing, you probably learned the following.

Equations of Vertical and Horizontal Lines

- The graph of the equation $x = a$ is a **vertical line** through $(a, 0)$.
- The graph of the equation $y = b$ is a **horizontal line** through $(0, b)$.

Given that the very simple equations $x = a$ and $y = b$ produced lines, it's natural to wonder what shapes other equations might yield. Thus our next objective is to study the graphs of equations in a more general setting as we continue to unite Algebra and Geometry.

1.2.1 GRAPHS OF EQUATIONS

In this section, we delve more deeply into the connection between Algebra and Geometry by focusing on graphing relations described by equations. The main idea of this section is the following.

The Fundamental Graphing Principle

The graph of an equation is the set of points which satisfy the equation. That is, a point (x, y) is on the graph of an equation if and only if x and y satisfy the equation.

Here, ' x and y satisfy the equation' means ' x and y make the equation true'. It is at this point that we gain some insight into the word 'relation'. If the equation to be graphed contains both x and y , then the equation itself is what is relating the two variables. More specifically, in the next two examples, we consider the graph of the equation $x^2 + y^3 = 1$. Even though it is not specifically

spelled out, what we are doing is graphing the relation $R = \{(x, y) \mid x^2 + y^3 = 1\}$. The points (x, y) we graph belong to the *relation* R and are necessarily *related* by the equation $x^2 + y^3 = 1$, since it is those pairs of x and y which make the equation true.

Example 1.2.2. Determine whether or not $(2, -1)$ is on the graph of $x^2 + y^3 = 1$.

Solution. We substitute $x = 2$ and $y = -1$ into the equation to see if the equation is satisfied.

$$\begin{aligned} (2)^2 + (-1)^3 &\stackrel{?}{=} 1 \\ 3 &\neq 1 \end{aligned}$$

Hence, $(2, -1)$ is **not** on the graph of $x^2 + y^3 = 1$. □

We could spend hours randomly guessing and checking to see if points are on the graph of the equation. A more systematic approach is outlined in the following example.

Example 1.2.3. Graph $x^2 + y^3 = 1$.

Solution. To efficiently generate points on the graph of this equation, we first solve for y

$$\begin{aligned} x^2 + y^3 &= 1 \\ y^3 &= 1 - x^2 \\ \sqrt[3]{y^3} &= \sqrt[3]{1 - x^2} \\ y &= \sqrt[3]{1 - x^2} \end{aligned}$$

We now substitute a value in for x , determine the corresponding value y , and plot the resulting point (x, y) . For example, substituting $x = -3$ into the equation yields

$$y = \sqrt[3]{1 - x^2} = \sqrt[3]{1 - (-3)^2} = \sqrt[3]{-8} = -2,$$

so the point $(-3, -2)$ is on the graph. Continuing in this manner, we generate a table of points which are on the graph of the equation. These points are then plotted in the plane as shown below.

x	y	(x, y)
-3	-2	$(-3, -2)$
-2	$-\sqrt[3]{3}$	$(-2, -\sqrt[3]{3})$
-1	0	$(-1, 0)$
0	1	$(0, 1)$
1	0	$(1, 0)$
2	$-\sqrt[3]{3}$	$(2, -\sqrt[3]{3})$
3	-2	$(3, -2)$

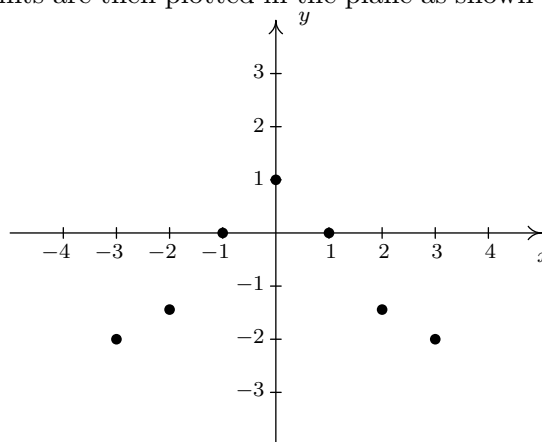

Remember, these points constitute only a small sampling of the points on the graph of this equation. To get a better idea of the shape of the graph, we could plot more points until we feel comfortable

‘connecting the dots’. Doing so would result in a curve similar to the one pictured below on the far left.

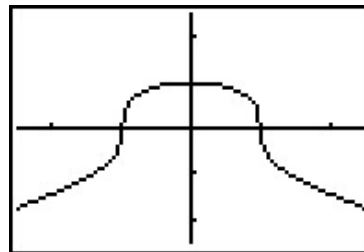
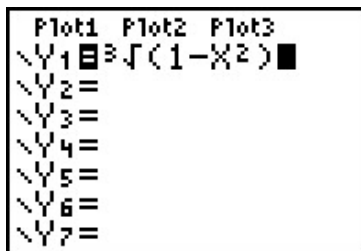
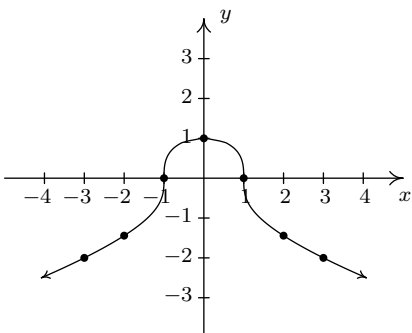

Don't worry if you don't get all of the little bends and curves just right – Calculus is where the art of precise graphing takes center stage. For now, we will settle with our naive ‘plug and plot’ approach to graphing. If you feel like all of this tedious computation and plotting is beneath you, then you can reach for a graphing calculator, input the formula as shown above, and graph. \square

Of all of the points on the graph of an equation, the places where the graph crosses or touches the axes hold special significance. These are called the **intercepts** of the graph. Intercepts come in two distinct varieties: x -intercepts and y -intercepts. They are defined below.

Definition 1.5. Suppose the graph of an equation is given.

- A point on a graph which is also on the x -axis is called an **x -intercept** of the graph.
- A point on a graph which is also on the y -axis is called an **y -intercept** of the graph.

In our previous example the graph had two x -intercepts, $(-1, 0)$ and $(1, 0)$, and one y -intercept, $(0, 1)$. The graph of an equation can have any number of intercepts, including none at all! Since x -intercepts lie on the x -axis, we can find them by setting $y = 0$ in the equation. Similarly, since y -intercepts lie on the y -axis, we can find them by setting $x = 0$ in the equation. Keep in mind, intercepts are *points* and therefore must be written as ordered pairs. To summarize,

Finding the Intercepts of the Graph of an Equation

Given an equation involving x and y , we find the intercepts of the graph as follows:

- x -intercepts have the form $(x, 0)$; set $y = 0$ in the equation and solve for x .
- y -intercepts have the form $(0, y)$; set $x = 0$ in the equation and solve for y .

Another fact which you may have noticed about the graph in the previous example is that it seems to be symmetric about the y -axis. To actually prove this analytically, we assume (x, y) is a generic point on the graph of the equation. That is, we assume $x^2 + y^3 = 1$ is true. As we learned in Section 1.1, the point symmetric to (x, y) about the y -axis is $(-x, y)$. To show that the graph is

symmetric about the y -axis, we need to show that $(-x, y)$ satisfies the equation $x^2 + y^3 = 1$, too. Substituting $(-x, y)$ into the equation gives

$$\begin{aligned} (-x)^2 + (y)^3 &\stackrel{?}{=} 1 \\ x^2 + y^3 &\stackrel{\checkmark}{=} 1 \end{aligned}$$

Since we are assuming the original equation $x^2 + y^3 = 1$ is true, we have shown that $(-x, y)$ satisfies the equation (since it leads to a true result) and hence is on the graph. In this way, we can check whether the graph of a given equation possesses any of the symmetries discussed in Section 1.1. We summarize the procedure in the following result.

Testing the Graph of an Equation for Symmetry

To test the graph of an equation for symmetry

- about the y -axis – substitute $(-x, y)$ into the equation and simplify. If the result is equivalent to the original equation, the graph is symmetric about the y -axis.
- about the x -axis – substitute $(x, -y)$ into the equation and simplify. If the result is equivalent to the original equation, the graph is symmetric about the x -axis.
- about the origin – substitute $(-x, -y)$ into the equation and simplify. If the result is equivalent to the original equation, the graph is symmetric about the origin.

Intercepts and symmetry are two tools which can help us sketch the graph of an equation analytically, as demonstrated in the next example.

Example 1.2.4. Find the x - and y -intercepts (if any) of the graph of $(x - 2)^2 + y^2 = 1$. Test for symmetry. Plot additional points as needed to complete the graph.

Solution. To look for x -intercepts, we set $y = 0$ and solve

$$\begin{aligned} (x - 2)^2 + y^2 &= 1 \\ (x - 2)^2 + 0^2 &= 1 \\ (x - 2)^2 &= 1 \\ \sqrt{(x - 2)^2} &= \sqrt{1} && \text{extract square roots} \\ x - 2 &= \pm 1 \\ x &= 2 \pm 1 \\ x &= 3, 1 \end{aligned}$$

We get two answers for x which correspond to two x -intercepts: $(1, 0)$ and $(3, 0)$. Turning our attention to y -intercepts, we set $x = 0$ and solve

$$\begin{aligned}(x - 2)^2 + y^2 &= 1 \\(0 - 2)^2 + y^2 &= 1 \\4 + y^2 &= 1 \\y^2 &= -3\end{aligned}$$

Since there is no real number which squares to a negative number (Do you remember why?), we are forced to conclude that the graph has no y -intercepts.

Plotting the data we have so far, we get

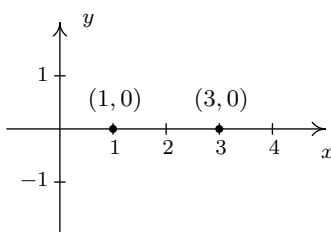

Moving along to symmetry, we can immediately dismiss the possibility that the graph is symmetric about the y -axis or the origin. If the graph possessed either of these symmetries, then the fact that $(1, 0)$ is on the graph would mean $(-1, 0)$ would have to be on the graph. (Why?) Since $(-1, 0)$ would be another x -intercept (and we've found all of these), the graph can't have y -axis or origin symmetry. The only symmetry left to test is symmetry about the x -axis. To that end, we substitute $(x, -y)$ into the equation and simplify

$$\begin{aligned}(x - 2)^2 + y^2 &= 1 \\(x - 2)^2 + (-y)^2 &\stackrel{?}{=} 1 \\(x - 2)^2 + y^2 &\stackrel{\checkmark}{=} 1\end{aligned}$$

Since we have obtained our original equation, we know the graph is symmetric about the x -axis. This means we can cut our 'plug and plot' time in half: whatever happens below the x -axis is reflected above the x -axis, and vice-versa. Proceeding as we did in the previous example, we obtain

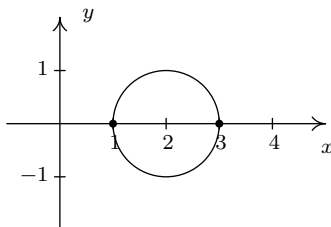

□

A couple of remarks are in order. First, it is entirely possible to choose a value for x which does not correspond to a point on the graph. For example, in the previous example, if we solve for y as is our custom, we get

$$y = \pm\sqrt{1 - (x - 2)^2}.$$

Upon substituting $x = 0$ into the equation, we would obtain

$$y = \pm\sqrt{1 - (0 - 2)^2} = \pm\sqrt{1 - 4} = \pm\sqrt{-3},$$

which is not a real number. This means there are no points on the graph with an x -coordinate of 0. When this happens, we move on and try another point. This is another drawback of the ‘plug-and-plot’ approach to graphing equations. Luckily, we will devote much of the remainder of this book to developing techniques which allow us to graph entire families of equations quickly.⁶ Second, it is instructive to show what would have happened had we tested the equation in the last example for symmetry about the y -axis. Substituting $(-x, y)$ into the equation yields

$$\begin{aligned} (x - 2)^2 + y^2 &= 1 \\ (-x - 2)^2 + y^2 &\stackrel{?}{=} 1 \\ ((-1)(x + 2))^2 + y^2 &\stackrel{?}{=} 1 \\ (x + 2)^2 + y^2 &\stackrel{?}{=} 1. \end{aligned}$$

This last equation does not *appear* to be equivalent to our original equation. However, to actually prove that the graph is not symmetric about the y -axis, we need to find a point (x, y) on the graph whose reflection $(-x, y)$ is not. Our x -intercept $(1, 0)$ fits this bill nicely, since if we substitute $(-1, 0)$ into the equation we get

$$\begin{aligned} (x - 2)^2 + y^2 &\stackrel{?}{=} 1 \\ (-1 - 2)^2 + 0^2 &\neq 1 \\ 9 &\neq 1. \end{aligned}$$

This proves that $(-1, 0)$ is not on the graph.

⁶Without the use of a calculator, if you can believe it!

1.2.2 EXERCISES

In Exercises 1 - 20, graph the given relation.

1. $\{(-3, 9), (-2, 4), (-1, 1), (0, 0), (1, 1), (2, 4), (3, 9)\}$
2. $\{(-2, 0), (-1, 1), (-1, -1), (0, 2), (0, -2), (1, 3), (1, -3)\}$
3. $\{(m, 2m) \mid m = 0, \pm 1, \pm 2\}$
4. $\{(\frac{6}{k}, k) \mid k = \pm 1, \pm 2, \pm 3, \pm 4, \pm 5, \pm 6\}$
5. $\{(n, 4 - n^2) \mid n = 0, \pm 1, \pm 2\}$
6. $\{(\sqrt{j}, j) \mid j = 0, 1, 4, 9\}$
7. $\{(x, -2) \mid x > -4\}$
8. $\{(x, 3) \mid x \leq 4\}$
9. $\{(-1, y) \mid y > 1\}$
10. $\{(2, y) \mid y \leq 5\}$
11. $\{(-2, y) \mid -3 < y \leq 4\}$
12. $\{(3, y) \mid -4 \leq y < 3\}$
13. $\{(x, 2) \mid -2 \leq x < 3\}$
14. $\{(x, -3) \mid -4 < x \leq 4\}$
15. $\{(x, y) \mid x > -2\}$
16. $\{(x, y) \mid x \leq 3\}$
17. $\{(x, y) \mid y < 4\}$
18. $\{(x, y) \mid x \leq 3, y < 2\}$
19. $\{(x, y) \mid x > 0, y < 4\}$
20. $\{(x, y) \mid -\sqrt{2} \leq x \leq \frac{2}{3}, \pi < y \leq \frac{9}{2}\}$

In Exercises 21 - 30, describe the given relation using either the roster or set-builder method.

21.

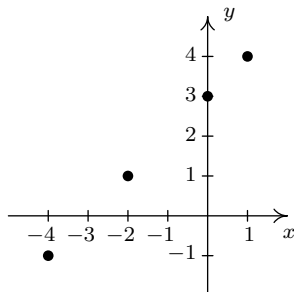

Relation A

22.

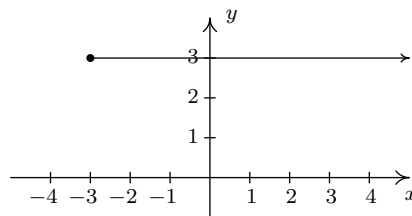

Relation B

23.

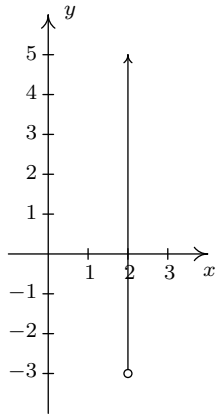
Relation C

24.

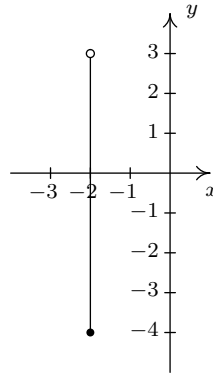
Relation D

25.

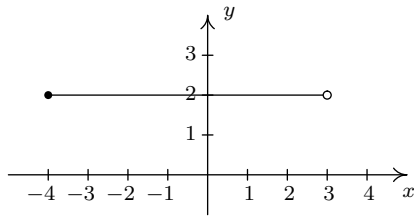
Relation E

26.

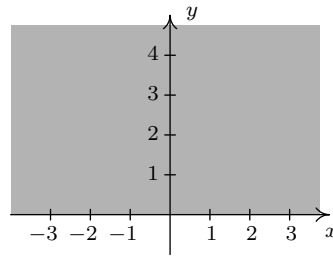
Relation F

27.

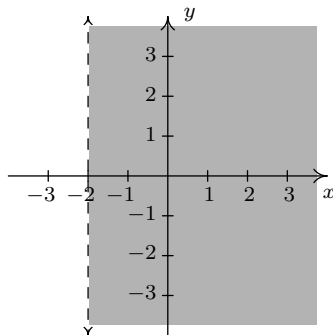
Relation G

28.

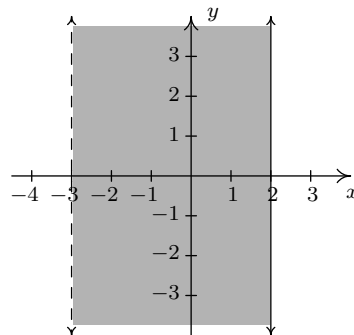
Relation H

29.

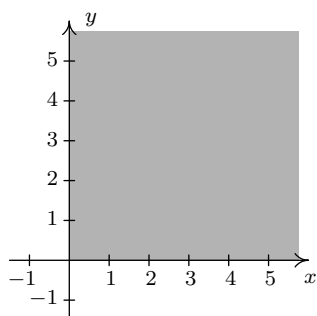
Relation I

30.

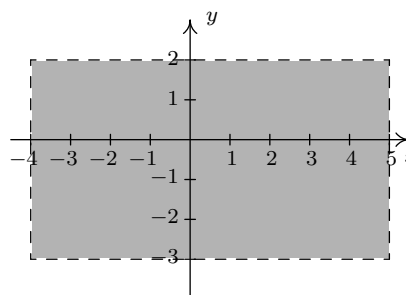
Relation J

In Exercises 31 - 36, graph the given line.

31. $x = -2$

32. $x = 3$

33. $y = 3$

34. $y = -2$

35. $x = 0$

36. $y = 0$

Some relations are fairly easy to describe in words or with the roster method but are rather difficult, if not impossible, to graph. Discuss with your classmates how you might graph the relations given in Exercises 37 - 40. Please note that in the notation below we are using the ellipsis, \dots , to denote that the list does not end, but rather, continues to follow the established pattern indefinitely. For the relations in Exercises 37 and 38, give two examples of points which belong to the relation and two points which do not belong to the relation.

37. $\{(x, y) \mid x \text{ is an odd integer, and } y \text{ is an even integer.}\}$

38. $\{(x, 1) \mid x \text{ is an irrational number}\}$

39. $\{(1, 0), (2, 1), (4, 2), (8, 3), (16, 4), (32, 5), \dots\}$

40. $\{\dots, (-3, 9), (-2, 4), (-1, 1), (0, 0), (1, 1), (2, 4), (3, 9), \dots\}$

For each equation given in Exercises 41 - 52:

- Find the x - and y -intercept(s) of the graph, if any exist.
- Follow the procedure in Example 1.2.3 to create a table of sample points on the graph of the equation.
- Plot the sample points and create a rough sketch of the graph of the equation.
- Test for symmetry. If the equation appears to fail any of the symmetry tests, find a point on the graph of the equation whose reflection fails to be on the graph as was done at the end of Example 1.2.4

41. $y = x^2 + 1$

42. $y = x^2 - 2x - 8$

43. $y = x^3 - x$

44. $y = \frac{x^3}{4} - 3x$

45. $y = \sqrt{x - 2}$

46. $y = 2\sqrt{x + 4} - 2$

47. $3x - y = 7$

48. $3x - 2y = 10$

49. $(x + 2)^2 + y^2 = 16$

50. $x^2 - y^2 = 1$

51. $4y^2 - 9x^2 = 36$

52. $x^3y = -4$

The procedures which we have outlined in the Examples of this section and used in Exercises 41 - 52 all rely on the fact that the equations were “well-behaved”. Not everything in Mathematics is quite so tame, as the following equations will show you. Discuss with your classmates how you might approach graphing the equations given in Exercises 53 - 56. What difficulties arise when trying to apply the various tests and procedures given in this section? For more information, including pictures of the curves, each curve name is a link to its page at www.wikipedia.org. For a much longer list of fascinating curves, click [here](#).

53. $x^3 + y^3 - 3xy = 0$ [Folium of Descartes](#)

54. $x^4 = x^2 + y^2$ [Kampyle of Eudoxus](#)

55. $y^2 = x^3 + 3x^2$ [Tschirnhausen cubic](#)

56. $(x^2 + y^2)^2 = x^3 + y^3$ [Crooked egg](#)

57. With the help of your classmates, find examples of equations whose graphs possess

- symmetry about the x -axis only
- symmetry about the y -axis only
- symmetry about the origin only
- symmetry about the x -axis, y -axis, and origin

Can you find an example of an equation whose graph possesses exactly *two* of the symmetries listed above? Why or why not?

1.2.3 ANSWERS

1.

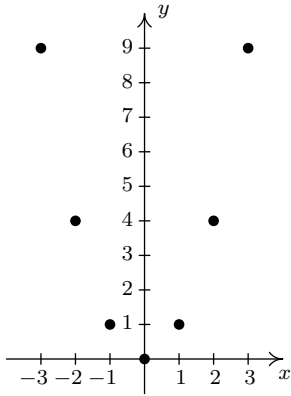

2.

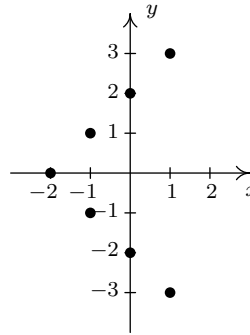

3.

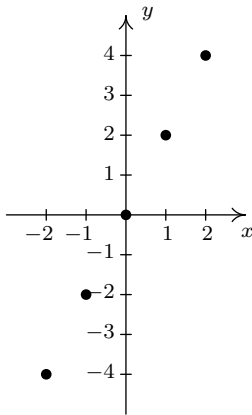

4.

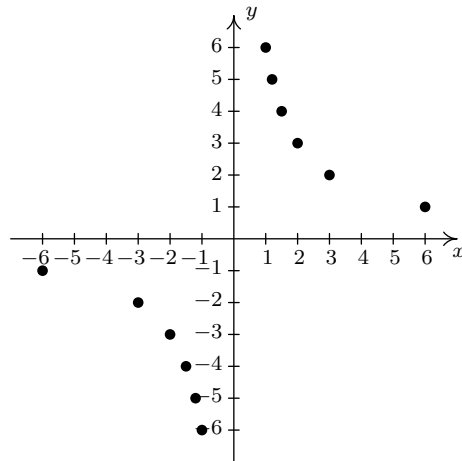

5.

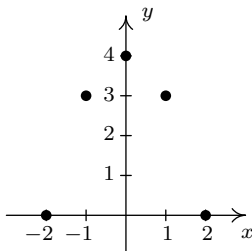

6.

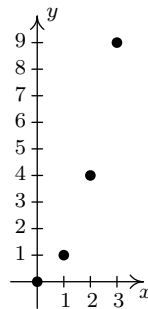

7.

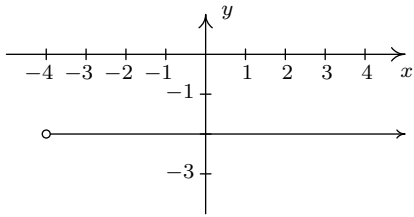

8.

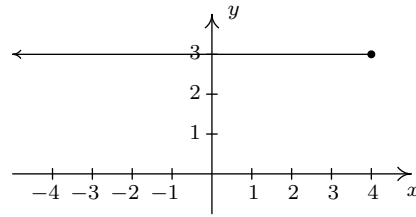

9.

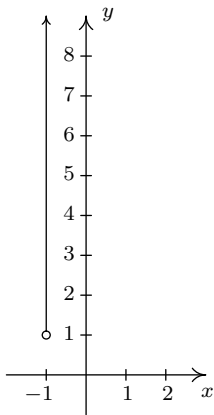

10.

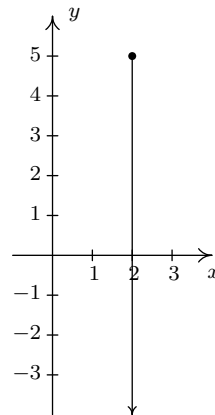

11.

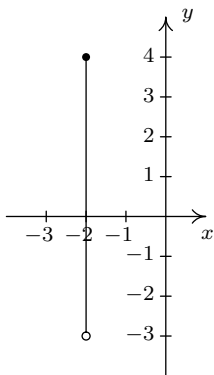

12.

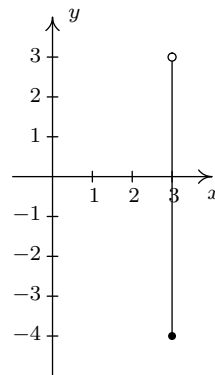

13.

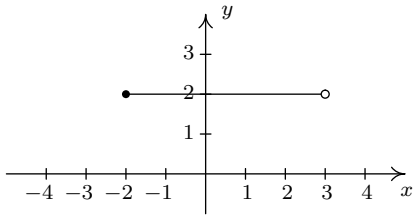

14.

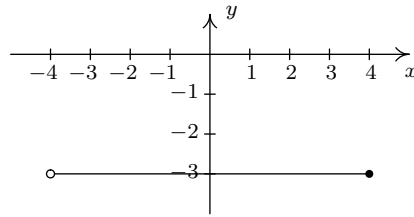

15.

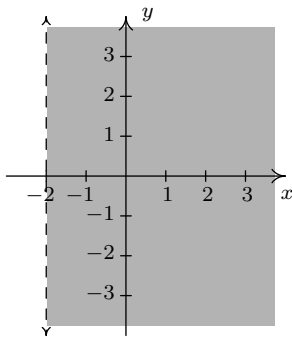

16.

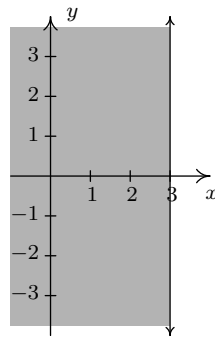

17.

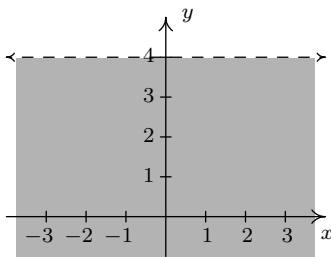

18.

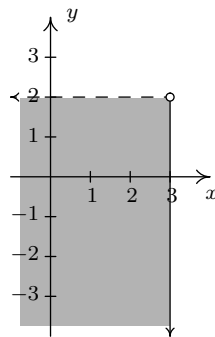

19.

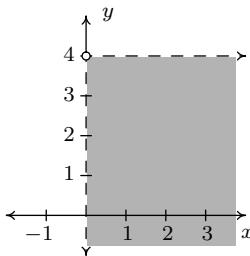

20.

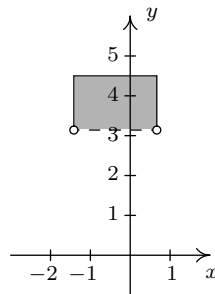

21. $A = \{(-4, -1), (-2, 1), (0, 3), (1, 4)\}$

23. $C = \{(2, y) \mid y > -3\}$

25. $E = \{(x, 2) \mid -4 \leq x < 3\}$

27. $G = \{(x, y) \mid x > -2\}$

29. $I = \{(x, y) \mid x \geq 0, y \geq 0\}$

31.

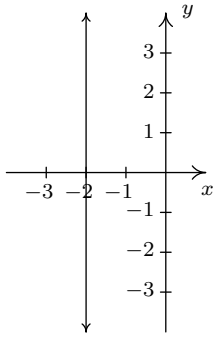
The line $x = -2$

22. $B = \{(x, 3) \mid x \geq -3\}$

24. $D = \{(-2, y) \mid -4 \leq y < 3\}$

26. $F = \{(x, y) \mid y \geq 0\}$

28. $H = \{(x, y) \mid -3 < x \leq 2\}$

30. $J = \{(x, y) \mid -4 < x < 5, -3 < y < 2\}$

32.

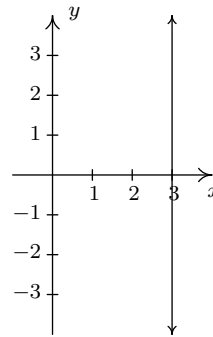
The line $x = 3$

33.

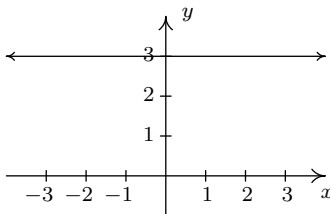
The line $y = 3$

34.

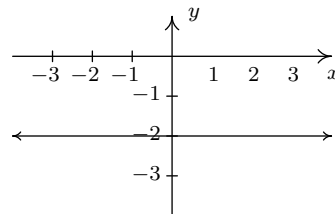
The line $y = -2$

35.

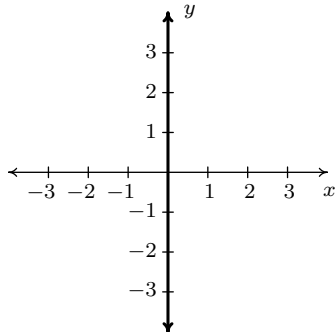
The line $x = 0$ is the y -axis

36.

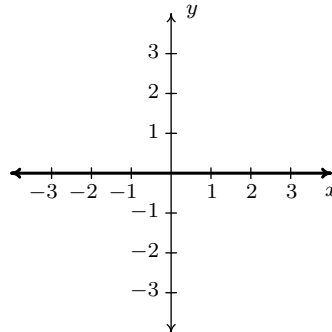
The line $y = 0$ is the x -axis

41. $y = x^2 + 1$

The graph has no x -intercepts

y -intercept: $(0, 1)$

x	y	(x, y)
-2	5	$(-2, 5)$
-1	2	$(-1, 2)$
0	1	$(0, 1)$
1	2	$(1, 2)$
2	5	$(2, 5)$

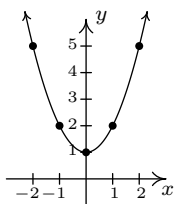

The graph is not symmetric about the x -axis (e.g. $(2, 5)$ is on the graph but $(2, -5)$ is not)

The graph is symmetric about the y -axis

The graph is not symmetric about the origin (e.g. $(2, 5)$ is on the graph but $(-2, -5)$ is not)

42. $y = x^2 - 2x - 8$

x -intercepts: $(4, 0)$, $(-2, 0)$

y -intercept: $(0, -8)$

x	y	(x, y)
-3	7	$(-3, 7)$
-2	0	$(-2, 0)$
-1	-5	$(-1, -5)$
0	-8	$(0, -8)$
1	-9	$(1, -9)$
2	-8	$(2, -8)$
3	-5	$(3, -5)$
4	0	$(4, 0)$
5	7	$(5, 7)$

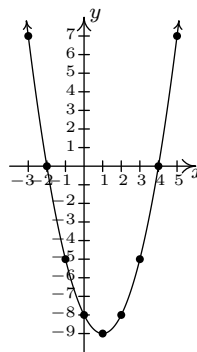

The graph is not symmetric about the x -axis (e.g. $(-3, 7)$ is on the graph but $(-3, -7)$ is not)

The graph is not symmetric about the y -axis (e.g. $(-3, 7)$ is on the graph but $(3, 7)$ is not)

The graph is not symmetric about the origin (e.g. $(-3, 7)$ is on the graph but $(3, -7)$ is not)

43. $y = x^3 - x$

 x -intercepts: $(-1, 0), (0, 0), (1, 0)$ y -intercept: $(0, 0)$

x	y	(x, y)
-2	-6	$(-2, -6)$
-1	0	$(-1, 0)$
0	0	$(0, 0)$
1	0	$(1, 0)$
2	6	$(2, 6)$

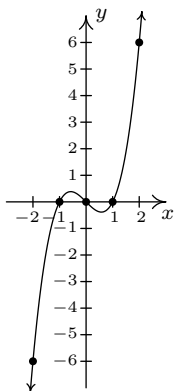

The graph is not symmetric about the x -axis. (e.g. $(2, 6)$ is on the graph but $(2, -6)$ is not)

The graph is not symmetric about the y -axis. (e.g. $(2, 6)$ is on the graph but $(-2, 6)$ is not)

The graph is symmetric about the origin.

44. $y = \frac{x^3}{4} - 3x$

 x -intercepts: $(\pm 2\sqrt{3}, 0), (0, 0)$ y -intercept: $(0, 0)$

x	y	(x, y)
-4	-4	$(-4, -4)$
-3	$\frac{9}{4}$	$(-3, \frac{9}{4})$
-2	4	$(-2, 4)$
-1	$\frac{11}{4}$	$(-1, \frac{11}{4})$
0	0	$(0, 0)$
1	$-\frac{11}{4}$	$(1, -\frac{11}{4})$
2	-4	$(2, -4)$
3	$-\frac{9}{4}$	$(3, -\frac{9}{4})$
4	4	$(4, 4)$

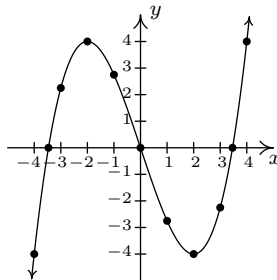

The graph is not symmetric about the x -axis (e.g. $(-4, -4)$ is on the graph but $(-4, 4)$ is not)

The graph is not symmetric about the y -axis (e.g. $(-4, -4)$ is on the graph but $(4, -4)$ is not)

The graph is symmetric about the origin

45. $y = \sqrt{x-2}$

 x -intercept: $(2, 0)$ The graph has no y -intercepts

x	y	(x, y)
2	0	$(2, 0)$
3	1	$(3, 1)$
6	2	$(6, 2)$
11	3	$(11, 3)$

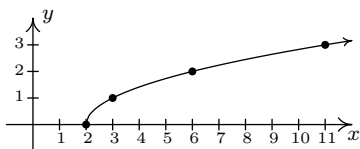

The graph is not symmetric about the x -axis (e.g. $(3, 1)$ is on the graph but $(3, -1)$ is not)

The graph is not symmetric about the y -axis (e.g. $(3, 1)$ is on the graph but $(-3, 1)$ is not)

The graph is not symmetric about the origin (e.g. $(3, 1)$ is on the graph but $(-3, -1)$ is not)

46. $y = 2\sqrt{x+4} - 2$

 x -intercept: $(-3, 0)$ y -intercept: $(0, 2)$

x	y	(x, y)
-4	-2	$(-4, -2)$
-3	0	$(-3, 0)$
-2	$2\sqrt{2} - 2$	$(-2, \sqrt{2} - 2)$
-1	$2\sqrt{3} - 2$	$(-2, \sqrt{3} - 2)$
0	2	$(0, 2)$
1	$2\sqrt{5} - 2$	$(-2, \sqrt{5} - 2)$

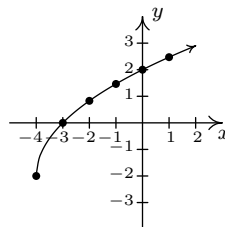

The graph is not symmetric about the x -axis (e.g. $(-4, -2)$ is on the graph but $(-4, 2)$ is not)

The graph is not symmetric about the y -axis (e.g. $(-4, -2)$ is on the graph but $(4, -2)$ is not)

The graph is not symmetric about the origin (e.g. $(-4, -2)$ is on the graph but $(4, 2)$ is not)

47. $3x - y = 7$

Re-write as: $y = 3x - 7$. x -intercept: $(\frac{7}{3}, 0)$ y -intercept: $(0, -7)$

x	y	(x, y)
-2	-13	$(-2, -13)$
-1	-10	$(-1, -10)$
0	-7	$(0, -7)$
1	-4	$(1, -4)$
2	-1	$(2, -1)$
3	2	$(3, 2)$

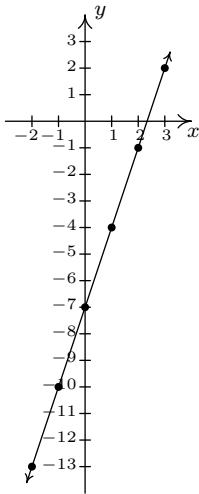

The graph is not symmetric about the x -axis (e.g. $(3, 2)$ is on the graph but $(3, -2)$ is not)

The graph is not symmetric about the y -axis (e.g. $(3, 2)$ is on the graph but $(-3, 2)$ is not)

The graph is not symmetric about the origin (e.g. $(3, 2)$ is on the graph but $(-3, -2)$ is not)

48. $3x - 2y = 10$

Re-write as: $y = \frac{3x-10}{2}$. x -intercepts: $(\frac{10}{3}, 0)$ y -intercept: $(0, -5)$

x	y	(x, y)
-2	-8	$(-2, -8)$
-1	$-\frac{13}{2}$	$(-1, -\frac{13}{2})$
0	-5	$(0, -5)$
1	$-\frac{7}{2}$	$(1, -\frac{7}{2})$
2	-2	$(2, -2)$

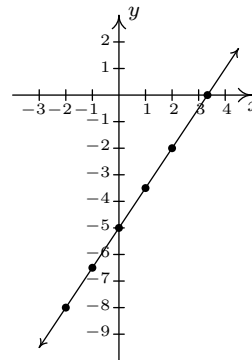

The graph is not symmetric about the x -axis (e.g. $(2, -2)$ is on the graph but $(2, 2)$ is not)

The graph is not symmetric about the y -axis (e.g. $(2, -2)$ is on the graph but $(-2, -2)$ is not)

The graph is not symmetric about the origin (e.g. $(2, -2)$ is on the graph but $(-2, 2)$ is not)

49. $(x + 2)^2 + y^2 = 16$

Re-write as $y = \pm\sqrt{16 - (x + 2)^2}$. x -intercepts: $(-6, 0), (2, 0)$ y -intercepts: $(0, \pm 2\sqrt{3})$

x	y	(x, y)
-6	0	$(-6, 0)$
-4	$\pm 2\sqrt{3}$	$(-4, \pm 2\sqrt{3})$
-2	± 4	$(-2, \pm 4)$
0	$\pm 2\sqrt{3}$	$(0, \pm 2\sqrt{3})$
2	0	$(2, 0)$

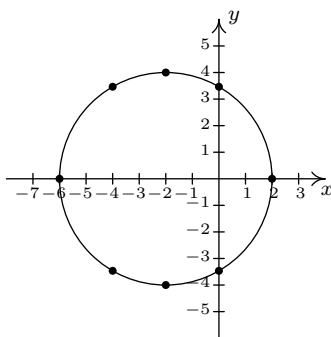
The graph is symmetric about the x -axisThe graph is not symmetric about the y -axis (e.g. $(-6, 0)$ is on the graph but $(6, 0)$ is not)The graph is not symmetric about the origin (e.g. $(-6, 0)$ is on the graph but $(6, 0)$ is not)

50. $x^2 - y^2 = 1$

Re-write as: $y = \pm\sqrt{x^2 - 1}$. x -intercepts: $(-1, 0), (1, 0)$ The graph has no y -intercepts

x	y	(x, y)
-3	$\pm\sqrt{8}$	$(-3, \pm\sqrt{8})$
-2	$\pm\sqrt{3}$	$(-2, \pm\sqrt{3})$
-1	0	$(-1, 0)$
1	0	$(1, 0)$
2	$\pm\sqrt{3}$	$(2, \pm\sqrt{3})$
3	$\pm\sqrt{8}$	$(3, \pm\sqrt{8})$

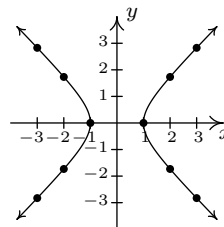
The graph is symmetric about the x -axisThe graph is symmetric about the y -axis

The graph is symmetric about the origin

51. $4y^2 - 9x^2 = 36$

Re-write as: $y = \pm \frac{\sqrt{9x^2+36}}{2}$.

The graph has no x -intercepts y -intercepts: $(0, \pm 3)$

x	y	(x, y)
-4	$\pm 3\sqrt{5}$	$(-4, \pm 3\sqrt{5})$
-2	$\pm 3\sqrt{2}$	$(-2, \pm 3\sqrt{2})$
0	± 3	$(0, \pm 3)$
2	$\pm 3\sqrt{2}$	$(2, \pm 3\sqrt{2})$
4	$\pm 3\sqrt{5}$	$(4, \pm 3\sqrt{5})$

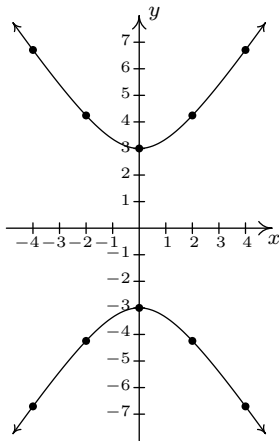
The graph is symmetric about the x -axisThe graph is symmetric about the y -axis

The graph is symmetric about the origin

52. $x^3y = -4$

Re-write as: $y = -\frac{4}{x^3}$.

The graph has no x -interceptsThe graph has no y -intercepts

x	y	(x, y)
-2	$\frac{1}{2}$	$(-2, \frac{1}{2})$
-1	4	$(-1, 4)$
$-\frac{1}{2}$	32	$(-\frac{1}{2}, 32)$
$\frac{1}{2}$	-32	$(\frac{1}{2}, -32)$
1	-4	$(1, -4)$
2	$-\frac{1}{2}$	$(2, -\frac{1}{2})$

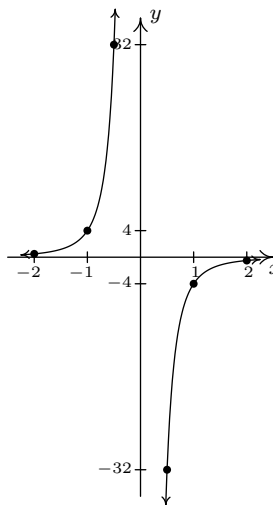
The graph is not symmetric about the x -axis (e.g. $(1, -4)$ is on the graph but $(1, 4)$ is not)The graph is not symmetric about the y -axis (e.g. $(1, -4)$ is on the graph but $(-1, -4)$ is not)

The graph is symmetric about the origin

1.3 INTRODUCTION TO FUNCTIONS

One of the core concepts in College Algebra is the **function**. There are many ways to describe a function and we begin by defining a function as a special kind of relation.

Definition 1.6. A relation in which each x -coordinate is matched with only one y -coordinate is said to describe y as a **function** of x .

Example 1.3.1. Which of the following relations describe y as a function of x ?

1. $R_1 = \{(-2, 1), (1, 3), (1, 4), (3, -1)\}$
2. $R_2 = \{(-2, 1), (1, 3), (2, 3), (3, -1)\}$

Solution. A quick scan of the points in R_1 reveals that the x -coordinate 1 is matched with two *different* y -coordinates: namely 3 and 4. Hence in R_1 , y is not a function of x . On the other hand, every x -coordinate in R_2 occurs only once which means each x -coordinate has only one corresponding y -coordinate. So, R_2 does represent y as a function of x . \square

Note that in the previous example, the relation R_2 contained two different points with the same y -coordinates, namely $(1, 3)$ and $(2, 3)$. Remember, in order to say y is a function of x , we just need to ensure the same x -coordinate isn't used in more than one point.¹

To see what the function concept means geometrically, we graph R_1 and R_2 in the plane.

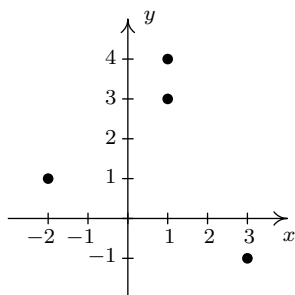

The graph of R_1

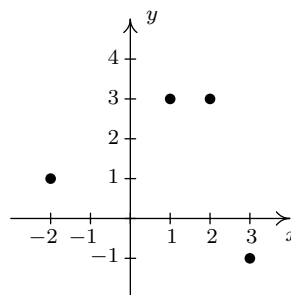

The graph of R_2

The fact that the x -coordinate 1 is matched with two different y -coordinates in R_1 presents itself graphically as the points $(1, 3)$ and $(1, 4)$ lying on the same vertical line, $x = 1$. If we turn our attention to the graph of R_2 , we see that no two points of the relation lie on the same vertical line. We can generalize this idea as follows

Theorem 1.1. The Vertical Line Test: A set of points in the plane represents y as a function of x if and only if no two points lie on the same vertical line.

¹We will have occasion later in the text to concern ourselves with the concept of x being a function of y . In this case, R_1 represents x as a function of y ; R_2 does not.

It is worth taking some time to meditate on the Vertical Line Test; it will check to see how well you understand the concept of ‘function’ as well as the concept of ‘graph’.

Example 1.3.2. Use the Vertical Line Test to determine which of the following relations describes y as a function of x .

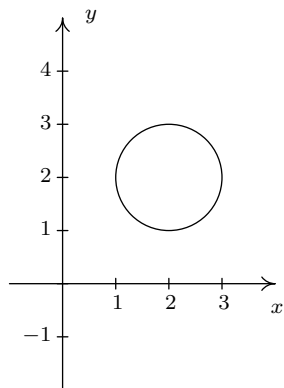
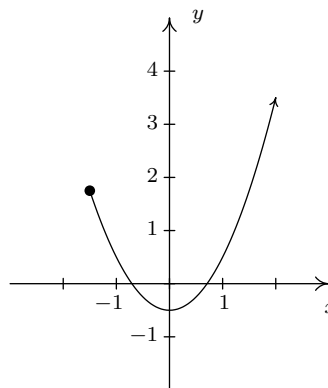
The graph of R The graph of S

Solution. Looking at the graph of R , we can easily imagine a vertical line crossing the graph more than once. Hence, R does not represent y as a function of x . However, in the graph of S , every vertical line crosses the graph at most once, so S does represent y as a function of x . \square

In the previous test, we say that the graph of the relation R **fails** the Vertical Line Test, whereas the graph of S **passes** the Vertical Line Test. Note that in the graph of R there are infinitely many vertical lines which cross the graph more than once. However, to fail the Vertical Line Test, all you need is one vertical line that fits the bill, as the next example illustrates.

Example 1.3.3. Use the Vertical Line Test to determine which of the following relations describes y as a function of x .

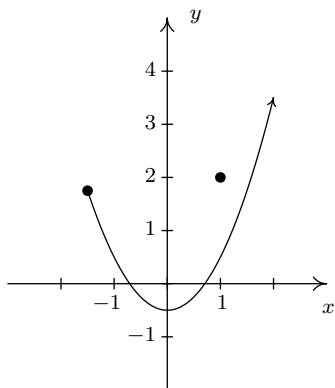
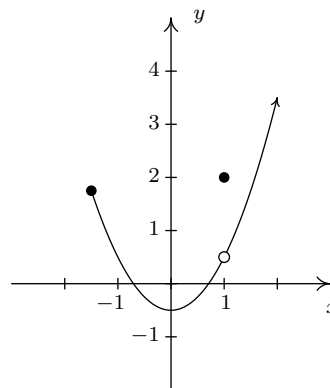
The graph of S_1 The graph of S_2

Solution. Both S_1 and S_2 are slight modifications to the relation S in the previous example whose graph we determined passed the Vertical Line Test. In both S_1 and S_2 , it is the addition of the point $(1, 2)$ which threatens to cause trouble. In S_1 , there is a point on the curve with x -coordinate 1 just below $(1, 2)$, which means that both $(1, 2)$ and this point on the curve lie on the vertical line $x = 1$. (See the picture below and the left.) Hence, the graph of S_1 fails the Vertical Line Test, so y is not a function of x here. However, in S_2 notice that the point with x -coordinate 1 on the curve has been omitted, leaving an ‘open circle’ there. Hence, the vertical line $x = 1$ crosses the graph of S_2 only at the point $(1, 2)$. Indeed, any vertical line will cross the graph at most once, so we have that the graph of S_2 passes the Vertical Line Test. Thus it describes y as a function of x . \square

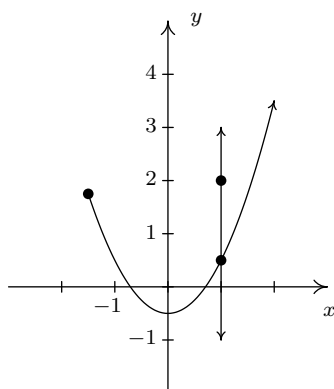

S_1 and the line $x = 1$

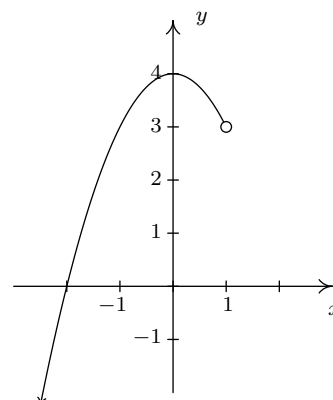

The graph of G for Ex. 1.3.4

Suppose a relation F describes y as a function of x . The sets of x - and y -coordinates are given special names which we define below.

Definition 1.7. Suppose F is a relation which describes y as a function of x .

- The set of the x -coordinates of the points in F is called the **domain** of F .
- The set of the y -coordinates of the points in F is called the **range** of F .

We demonstrate finding the domain and range of functions given to us either graphically or via the roster method in the following example.

Example 1.3.4. Find the domain and range of the function $F = \{(-3, 2), (0, 1), (4, 2), (5, 2)\}$ and of the function G whose graph is given above on the right.

Solution. The domain of F is the set of the x -coordinates of the points in F , namely $\{-3, 0, 4, 5\}$ and the range of F is the set of the y -coordinates, namely $\{1, 2\}$.

To determine the domain and range of G , we need to determine which x and y values occur as coordinates of points on the given graph. To find the domain, it may be helpful to imagine collapsing the curve to the x -axis and determining the portion of the x -axis that gets covered. This is called **projecting** the curve to the x -axis. Before we start projecting, we need to pay attention to two

subtle notations on the graph: the arrowhead on the lower left corner of the graph indicates that the graph continues to curve downwards to the left forever more; and the open circle at $(1, 3)$ indicates that the point $(1, 3)$ isn't on the graph, but all points on the curve leading up to that point are.

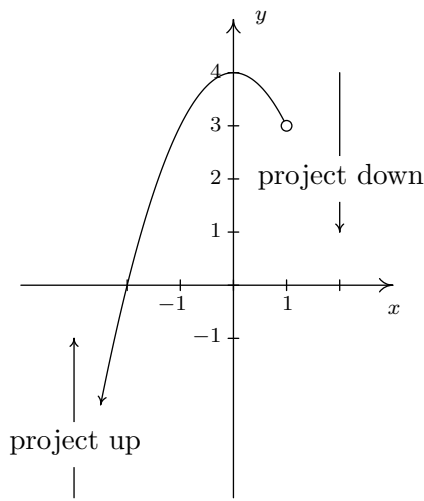
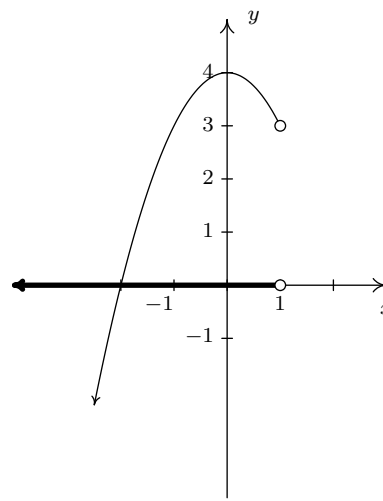
The graph of G The graph of G

We see from the figure that if we project the graph of G to the x -axis, we get all real numbers less than 1. Using interval notation, we write the domain of G as $(-\infty, 1)$. To determine the range of G , we project the curve to the y -axis as follows:

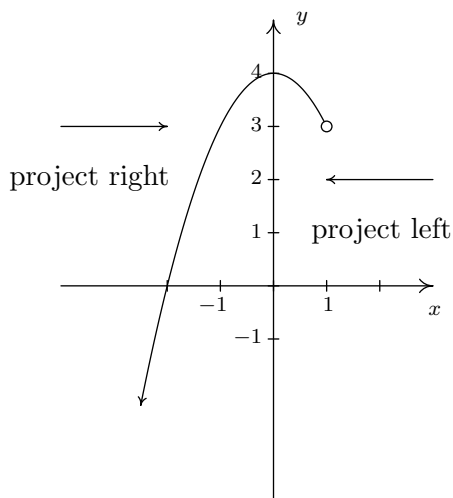
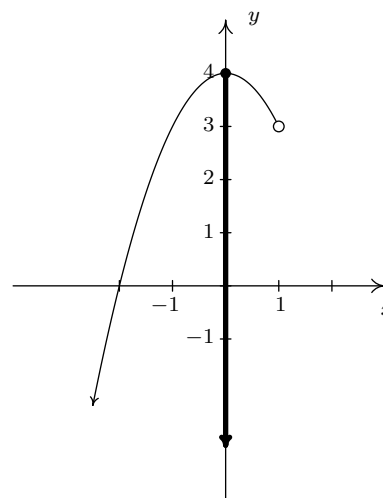
The graph of G The graph of G

Note that even though there is an open circle at $(1, 3)$, we still include the y value of 3 in our range, since the point $(-1, 3)$ is on the graph of G . We see that the range of G is all real numbers less than or equal to 4, or, in interval notation, $(-\infty, 4]$. \square

All functions are relations, but not all relations are functions. Thus the equations which described the relations in Section 1.2 may or may not describe y as a function of x . The algebraic representation of functions is possibly the most important way to view them so we need a process for determining whether or not an equation of a relation represents a function. (We delay the discussion of finding the domain of a function given algebraically until Section 1.4.)

Example 1.3.5. Determine which equations represent y as a function of x .

1. $x^3 + y^2 = 1$

2. $x^2 + y^3 = 1$

3. $x^2y = 1 - 3y$

Solution. For each of these equations, we solve for y and determine whether each choice of x will determine only one corresponding value of y .

1.

$$\begin{aligned} x^3 + y^2 &= 1 \\ y^2 &= 1 - x^3 \\ \sqrt{y^2} &= \sqrt{1 - x^3} && \text{extract square roots} \\ y &= \pm\sqrt{1 - x^3} \end{aligned}$$

If we substitute $x = 0$ into our equation for y , we get $y = \pm\sqrt{1 - 0^3} = \pm 1$, so that $(0, 1)$ and $(0, -1)$ are on the graph of this equation. Hence, this equation does not represent y as a function of x .

2.

$$\begin{aligned} x^2 + y^3 &= 1 \\ y^3 &= 1 - x^2 \\ \sqrt[3]{y^3} &= \sqrt[3]{1 - x^2} \\ y &= \sqrt[3]{1 - x^2} \end{aligned}$$

For every choice of x , the equation $y = \sqrt[3]{1 - x^2}$ returns only **one** value of y . Hence, this equation describes y as a function of x .

3.

$$\begin{aligned} x^2y &= 1 - 3y \\ x^2y + 3y &= 1 \\ y(x^2 + 3) &= 1 && \text{factor} \\ y &= \frac{1}{x^2 + 3} \end{aligned}$$

For each choice of x , there is only one value for y , so this equation describes y as a function of x . \square

We could try to use our graphing calculator to verify our responses to the previous example, but we immediately run into trouble. The calculator's "Y=" menu requires that the equation be of the form ' $y = \text{some expression of } x$ '. If we wanted to verify that the first equation in Example 1.3.5

does not represent y as a function of x , we would need to enter two separate expressions into the calculator: one for the positive square root and one for the negative square root we found when solving the equation for y . As predicted, the resulting graph shown below clearly fails the Vertical Line Test, so the equation does not represent y as a function of x .

```

Plot1 Plot2 Plot3
Y1=√(1-X^3)
Y2=-√(1-X^3)
Y3=
Y4=
Y5=
Y6=
Y7=

```

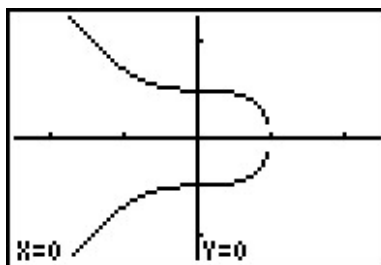

Thus in order to use the calculator to show that $x^3 + y^2 = 1$ does not represent y as a function of x we needed to know *analytically* that y was not a function of x so that we could use the calculator properly. There are more advanced graphing utilities out there which can do implicit function plots, but you need to know even more Algebra to make them work properly. Do you get the point we're trying to make here? We believe it is in your best interest to learn the analytic way of doing things so that you are always smarter than your calculator.

1.3.1 EXERCISES

In Exercises 1 - 12, determine whether or not the relation represents y as a function of x . Find the domain and range of those relations which are functions.

1. $\{(-3, 9), (-2, 4), (-1, 1), (0, 0), (1, 1), (2, 4), (3, 9)\}$

2. $\{(-3, 0), (1, 6), (2, -3), (4, 2), (-5, 6), (4, -9), (6, 2)\}$

3. $\{(-3, 0), (-7, 6), (5, 5), (6, 4), (4, 9), (3, 0)\}$

4. $\{(1, 2), (4, 4), (9, 6), (16, 8), (25, 10), (36, 12), \dots\}$

5. $\{(x, y) \mid x \text{ is an odd integer, and } y \text{ is an even integer}\}$

6. $\{(x, 1) \mid x \text{ is an irrational number}\}$

7. $\{(1, 0), (2, 1), (4, 2), (8, 3), (16, 4), (32, 5), \dots\}$

8. $\{\dots, (-3, 9), (-2, 4), (-1, 1), (0, 0), (1, 1), (2, 4), (3, 9), \dots\}$

9. $\{(-2, y) \mid -3 < y < 4\}$

10. $\{(x, 3) \mid -2 \leq x < 4\}$

11. $\{(x, x^2) \mid x \text{ is a real number}\}$

12. $\{(x^2, x) \mid x \text{ is a real number}\}$

In Exercises 13 - 32, determine whether or not the relation represents y as a function of x . Find the domain and range of those relations which are functions.

13.

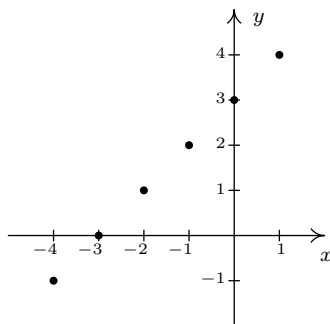

14.

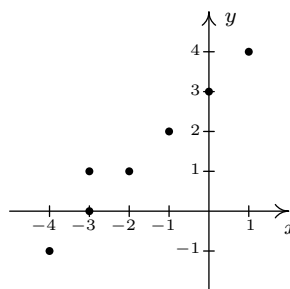

15.

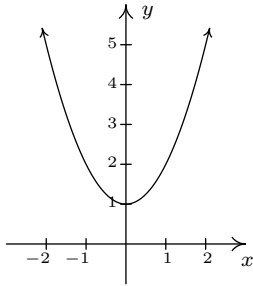

16.

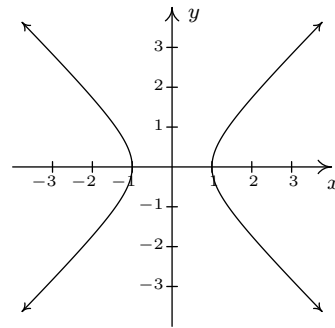

17.

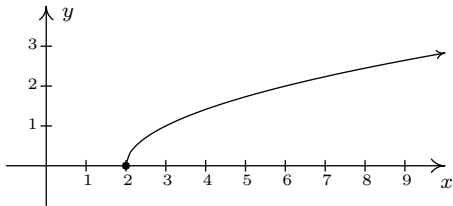

18.

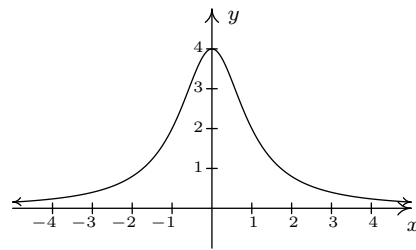

19.

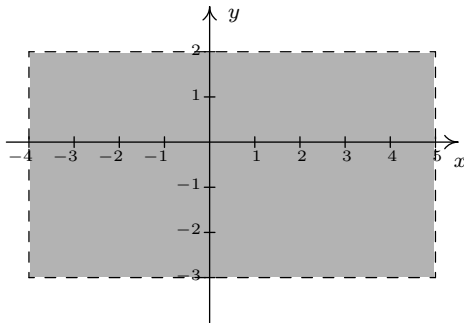

20.

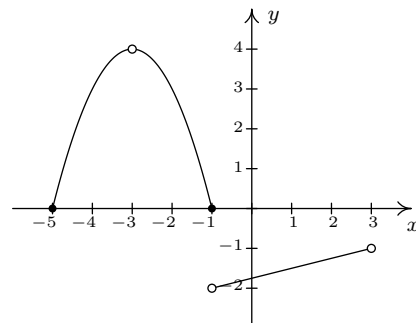

21.

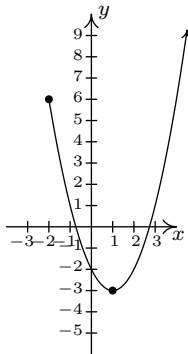

22.

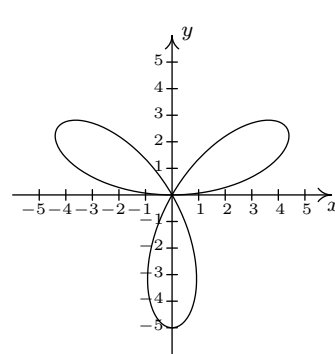

23.

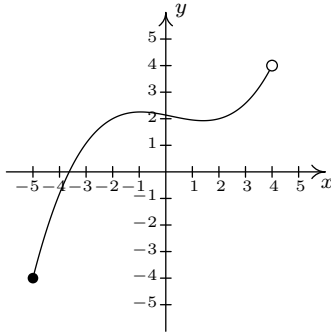

24.

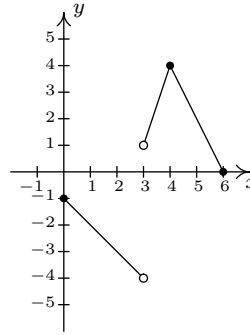

25.

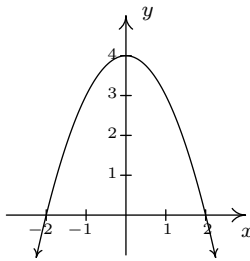

26.

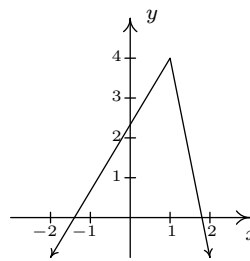

27.

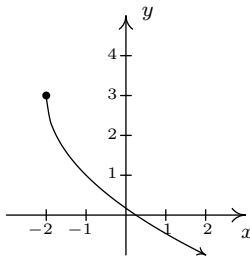

28.

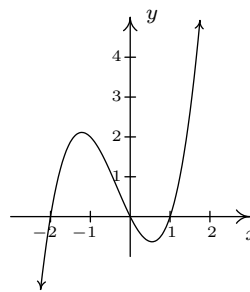

29.

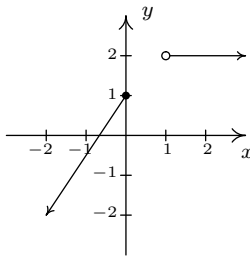

30.

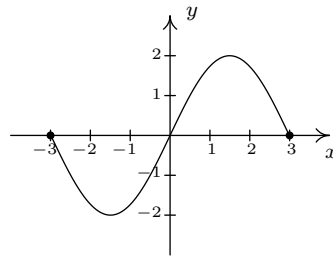

31.

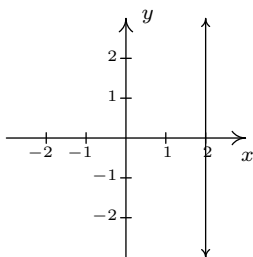

32.

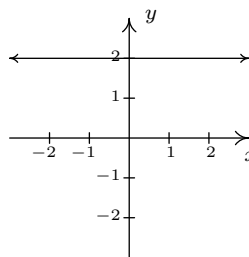

In Exercises 33 - 47, determine whether or not the equation represents y as a function of x .

33. $y = x^3 - x$

34. $y = \sqrt{x - 2}$

35. $x^3y = -4$

36. $x^2 - y^2 = 1$

37. $y = \frac{x}{x^2 - 9}$

38. $x = -6$

39. $x = y^2 + 4$

40. $y = x^2 + 4$

41. $x^2 + y^2 = 4$

42. $y = \sqrt{4 - x^2}$

43. $x^2 - y^2 = 4$

44. $x^3 + y^3 = 4$

45. $2x + 3y = 4$

46. $2xy = 4$

47. $x^2 = y^2$

48. Explain why the population P of Sasquatch in a given area is a function of time t . What would be the range of this function?

49. Explain why the relation between your classmates and their email addresses may not be a function. What about phone numbers and Social Security Numbers?

The process given in Example 1.3.5 for determining whether an equation of a relation represents y as a function of x breaks down if we cannot solve the equation for y in terms of x . However, that does not prevent us from proving that an equation fails to represent y as a function of x . What we really need is two points with the same x -coordinate and different y -coordinates which both satisfy the equation so that the graph of the relation would fail the Vertical Line Test 1.1. Discuss with your classmates how you might find such points for the relations given in Exercises 50 - 53.

50. $x^3 + y^3 - 3xy = 0$

51. $x^4 = x^2 + y^2$

52. $y^2 = x^3 + 3x^2$

53. $(x^2 + y^2)^2 = x^3 + y^3$

1.3.2 ANSWERS

1. Function
domain = $\{-3, -2, -1, 0, 1, 2, 3\}$
range = $\{0, 1, 4, 9\}$
2. Not a function
3. Function
domain = $\{-7, -3, 3, 4, 5, 6\}$
range = $\{0, 4, 5, 6, 9\}$
4. Function
domain = $\{1, 4, 9, 16, 25, 36, \dots\}$
 $= \{x \mid x \text{ is a perfect square}\}$
range = $\{2, 4, 6, 8, 10, 12, \dots\}$
 $= \{y \mid y \text{ is a positive even integer}\}$
5. Not a function
6. Function
domain = $\{x \mid x \text{ is irrational}\}$
range = $\{1\}$
7. Function
domain = $\{x \mid x = 2^n \text{ for some whole number } n\}$
range = $\{y \mid y \text{ is any whole number}\}$
8. Function
domain = $\{x \mid x \text{ is any integer}\}$
range = $\{y \mid y = n^2 \text{ for some integer } n\}$
9. Not a function
10. Function
domain = $[-2, 4)$, range = $\{3\}$
11. Function
domain = $(-\infty, \infty)$
range = $[0, \infty)$
12. Not a function
13. Function
domain = $\{-4, -3, -2, -1, 0, 1\}$
range = $\{-1, 0, 1, 2, 3, 4\}$
14. Not a function
15. Function
domain = $(-\infty, \infty)$
range = $[1, \infty)$
16. Not a function
17. Function
domain = $[2, \infty)$
range = $[0, \infty)$
18. Function
domain = $(-\infty, \infty)$
range = $(0, 4]$
19. Not a function
20. Function
domain = $[-5, -3) \cup (-3, 3)$
range = $(-2, -1) \cup [0, 4)$

21. Function
 domain = $[-2, \infty)$
 range = $[-3, \infty)$

23. Function
 domain = $[-5, 4)$
 range = $[-4, 4)$

25. Function
 domain = $(-\infty, \infty)$
 range = $(-\infty, 4]$

27. Function
 domain = $[-2, \infty)$
 range = $(-\infty, 3]$

29. Function
 domain = $(-\infty, 0] \cup (1, \infty)$
 range = $(-\infty, 1] \cup \{2\}$

31. Not a function

33. Function

36. Not a function

39. Not a function

42. Function

45. Function

22. Not a function

24. Function
 domain = $[0, 3) \cup (3, 6]$
 range = $(-4, -1] \cup [0, 4]$

26. Function
 domain = $(-\infty, \infty)$
 range = $(-\infty, 4]$

28. Function
 domain = $(-\infty, \infty)$
 range = $(-\infty, \infty)$

30. Function
 domain = $[-3, 3]$
 range = $[-2, 2]$

32. Function
 domain = $(-\infty, \infty)$
 range = $\{2\}$

34. Function

37. Function

40. Function

43. Not a function

46. Function

35. Function

38. Not a function

41. Not a function

44. Function

47. Not a function

1.4 FUNCTION NOTATION

In Definition 1.6, we described a function as a special kind of relation – one in which each x -coordinate is matched with only one y -coordinate. In this section, we focus more on the **process** by which the x is matched with the y . If we think of the domain of a function as a set of **inputs** and the range as a set of **outputs**, we can think of a function f as a process by which each input x is matched with only one output y . Since the output is completely determined by the input x and the process f , we symbolize the output with **function notation**: ' $f(x)$ ', read ' f of x .' In other words, $f(x)$ is the output which results by applying the process f to the input x . In this case, the parentheses here do not indicate multiplication, as they do elsewhere in Algebra. This can cause confusion if the context is not clear, so you must read carefully. This relationship is typically visualized using a diagram similar to the one below.

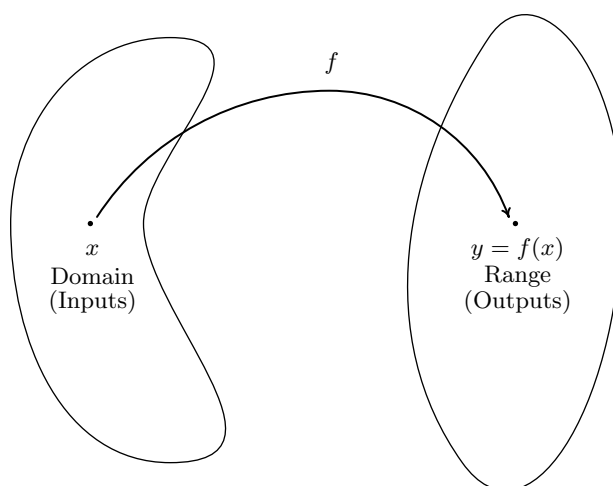

The value of y is completely dependent on the choice of x . For this reason, x is often called the **independent variable**, or **argument** of f , whereas y is often called the **dependent variable**.

As we shall see, the process of a function f is usually described using an algebraic formula. For example, suppose a function f takes a real number and performs the following two steps, in sequence

1. multiply by 3
2. add 4

If we choose 5 as our input, in step 1 we multiply by 3 to get $(5)(3) = 15$. In step 2, we add 4 to our result from step 1 which yields $15 + 4 = 19$. Using function notation, we would write $f(5) = 19$ to indicate that the result of applying the process f to the input 5 gives the output 19. In general, if we use x for the input, applying step 1 produces $3x$. Following with step 2 produces $3x + 4$ as our final output. Hence for an input x , we get the output $f(x) = 3x + 4$. Notice that to check our formula for the case $x = 5$, we replace the occurrence of x in the formula for $f(x)$ with 5 to get $f(5) = 3(5) + 4 = 15 + 4 = 19$, as required.

Example 1.4.1. Suppose a function g is described by applying the following steps, in sequence

1. add 4
2. multiply by 3

Determine $g(5)$ and find an expression for $g(x)$.

Solution. Starting with 5, step 1 gives $5 + 4 = 9$. Continuing with step 2, we get $(3)(9) = 27$. To find a formula for $g(x)$, we start with our input x . Step 1 produces $x + 4$. We now wish to multiply this entire quantity by 3, so we use a parentheses: $3(x + 4) = 3x + 12$. Hence, $g(x) = 3x + 12$. We can check our formula by replacing x with 5 to get $g(5) = 3(5) + 12 = 15 + 12 = 27 \checkmark$. \square

Most of the functions we will encounter in College Algebra will be described using formulas like the ones we developed for $f(x)$ and $g(x)$ above. Evaluating formulas using this function notation is a key skill for success in this and many other Math courses.

Example 1.4.2. Let $f(x) = -x^2 + 3x + 4$

1. Find and simplify the following.
 - (a) $f(-1)$, $f(0)$, $f(2)$
 - (b) $f(2x)$, $2f(x)$
 - (c) $f(x + 2)$, $f(x) + 2$, $f(x) + f(2)$
2. Solve $f(x) = 4$.

Solution.

1. (a) To find $f(-1)$, we replace every occurrence of x in the expression $f(x)$ with -1

$$\begin{aligned} f(-1) &= -(-1)^2 + 3(-1) + 4 \\ &= -(1) + (-3) + 4 \\ &= 0 \end{aligned}$$

Similarly, $f(0) = -(0)^2 + 3(0) + 4 = 4$, and $f(2) = -(2)^2 + 3(2) + 4 = -4 + 6 + 4 = 6$.

- (b) To find $f(2x)$, we replace every occurrence of x with the quantity $2x$

$$\begin{aligned} f(2x) &= -(2x)^2 + 3(2x) + 4 \\ &= -(4x^2) + (6x) + 4 \\ &= -4x^2 + 6x + 4 \end{aligned}$$

The expression $2f(x)$ means we multiply the expression $f(x)$ by 2

$$\begin{aligned} 2f(x) &= 2(-x^2 + 3x + 4) \\ &= -2x^2 + 6x + 8 \end{aligned}$$

(c) To find $f(x + 2)$, we replace every occurrence of x with the quantity $x + 2$

$$\begin{aligned} f(x + 2) &= -(x + 2)^2 + 3(x + 2) + 4 \\ &= -(x^2 + 4x + 4) + (3x + 6) + 4 \\ &= -x^2 - 4x - 4 + 3x + 6 + 4 \\ &= -x^2 - x + 6 \end{aligned}$$

To find $f(x) + 2$, we add 2 to the expression for $f(x)$

$$\begin{aligned} f(x) + 2 &= (-x^2 + 3x + 4) + 2 \\ &= -x^2 + 3x + 6 \end{aligned}$$

From our work above, we see $f(2) = 6$ so that

$$\begin{aligned} f(x) + f(2) &= (-x^2 + 3x + 4) + 6 \\ &= -x^2 + 3x + 10 \end{aligned}$$

2. Since $f(x) = -x^2 + 3x + 4$, the equation $f(x) = 4$ is equivalent to $-x^2 + 3x + 4 = 4$. Solving we get $-x^2 + 3x = 0$, or $x(-x + 3) = 0$. We get $x = 0$ or $x = 3$, and we can verify these answers by checking that $f(0) = 4$ and $f(3) = 4$. \square

A few notes about Example 1.4.2 are in order. First note the difference between the answers for $f(2x)$ and $2f(x)$. For $f(2x)$, we are multiplying the *input* by 2; for $2f(x)$, we are multiplying the *output* by 2. As we see, we get entirely different results. Along these lines, note that $f(x + 2)$, $f(x) + 2$ and $f(x) + f(2)$ are three *different* expressions as well. Even though function notation uses parentheses, as does multiplication, there is *no* general ‘distributive property’ of function notation. Finally, note the practice of using parentheses when substituting one algebraic expression into another; we highly recommend this practice as it will reduce careless errors.

Suppose now we wish to find $r(3)$ for $r(x) = \frac{2x}{x^2 - 9}$. Substitution gives

$$r(3) = \frac{2(3)}{(3)^2 - 9} = \frac{6}{0},$$

which is undefined. (Why is this, again?) The number 3 is not an allowable input to the function r ; in other words, 3 is not in the domain of r . Which other real numbers are forbidden in this formula? We think back to arithmetic. The reason $r(3)$ is undefined is because substitution results in a division by 0. To determine which other numbers result in such a transgression, we set the denominator equal to 0 and solve

$$\begin{aligned} x^2 - 9 &= 0 \\ x^2 &= 9 \\ \sqrt{x^2} &= \sqrt{9} \quad \text{extract square roots} \\ x &= \pm 3 \end{aligned}$$

As long as we substitute numbers other than 3 and -3 , the expression $r(x)$ is a real number. Hence, we write our domain in interval notation¹ as $(-\infty, -3) \cup (-3, 3) \cup (3, \infty)$. When a formula for a function is given, we assume that the function is valid for all real numbers which make arithmetic sense when substituted into the formula. This set of numbers is often called the **implied domain**² of the function. At this stage, there are only two mathematical sins we need to avoid: division by 0 and extracting even roots of negative numbers. The following example illustrates these concepts.

Example 1.4.3. Find the domain³ of the following functions.

$$1. g(x) = \sqrt{4 - 3x}$$

$$2. h(x) = \sqrt[5]{4 - 3x}$$

$$3. f(x) = \frac{2}{1 - \frac{4x}{x - 3}}$$

$$4. F(x) = \frac{\sqrt[4]{2x + 1}}{x^2 - 1}$$

$$5. r(t) = \frac{4}{6 - \sqrt{t + 3}}$$

$$6. I(x) = \frac{3x^2}{x}$$

Solution.

1. The potential disaster for g is if the radicand⁴ is negative. To avoid this, we set $4 - 3x \geq 0$. From this, we get $3x \leq 4$ or $x \leq \frac{4}{3}$. What this shows is that as long as $x \leq \frac{4}{3}$, the expression $4 - 3x \geq 0$, and the formula $g(x)$ returns a real number. Our domain is $(-\infty, \frac{4}{3}]$.
2. The formula for $h(x)$ is hauntingly close to that of $g(x)$ with one key difference – whereas the expression for $g(x)$ includes an even indexed root (namely a square root), the formula for $h(x)$ involves an odd indexed root (the fifth root). Since odd roots of real numbers (even negative real numbers) are real numbers, there is no restriction on the inputs to h . Hence, the domain is $(-\infty, \infty)$.
3. In the expression for f , there are two denominators. We need to make sure neither of them is 0. To that end, we set each denominator equal to 0 and solve. For the ‘small’ denominator, we get $x - 3 = 0$ or $x = 3$. For the ‘large’ denominator

¹See the Exercises for Section 1.1.

²or, ‘implicit domain’

³The word ‘implied’ is, well, implied.

⁴The ‘radicand’ is the expression ‘inside’ the radical.

$$\begin{aligned}
1 - \frac{4x}{x-3} &= 0 \\
1 &= \frac{4x}{x-3} \\
(1)(x-3) &= \left(\frac{4x}{\cancel{x-3}}\right) (\cancel{x-3}) \quad \text{clear denominators} \\
x-3 &= 4x \\
-3 &= 3x \\
-1 &= x
\end{aligned}$$

So we get two real numbers which make denominators 0, namely $x = -1$ and $x = 3$. Our domain is all real numbers except -1 and 3 : $(-\infty, -1) \cup (-1, 3) \cup (3, \infty)$.

4. In finding the domain of F , we notice that we have two potentially hazardous issues: not only do we have a denominator, we have a fourth (even-indexed) root. Our strategy is to determine the restrictions imposed by each part and select the real numbers which satisfy both conditions. To satisfy the fourth root, we require $2x + 1 \geq 0$. From this we get $2x \geq -1$ or $x \geq -\frac{1}{2}$. Next, we round up the values of x which could cause trouble in the denominator by setting the denominator equal to 0. We get $x^2 - 1 = 0$, or $x = \pm 1$. Hence, in order for a real number x to be in the domain of F , $x \geq -\frac{1}{2}$ but $x \neq \pm 1$. In interval notation, this set is $[-\frac{1}{2}, 1) \cup (1, \infty)$.
5. Don't be put off by the 't' here. It is an independent variable representing a real number, just like x does, and is subject to the same restrictions. As in the previous problem, we have double danger here: we have a square root and a denominator. To satisfy the square root, we need a non-negative radicand so we set $t + 3 \geq 0$ to get $t \geq -3$. Setting the denominator equal to zero gives $6 - \sqrt{t+3} = 0$, or $\sqrt{t+3} = 6$. Squaring both sides gives $t + 3 = 36$, or $t = 33$. Since we squared both sides in the course of solving this equation, we need to check our answer.⁵ Sure enough, when $t = 33$, $6 - \sqrt{t+3} = 6 - \sqrt{36} = 0$, so $t = 33$ will cause problems in the denominator. At last we can find the domain of r : we need $t \geq -3$, but $t \neq 33$. Our final answer is $[-3, 33) \cup (33, \infty)$.
6. It's tempting to simplify $I(x) = \frac{3x^2}{x} = 3x$, and, since there are no longer any denominators, claim that there are no longer any restrictions. However, in simplifying $I(x)$, we are assuming $x \neq 0$, since $\frac{0}{0}$ is undefined.⁶ Proceeding as before, we find the domain of I to be all real numbers except 0: $(-\infty, 0) \cup (0, \infty)$. \square

It is worth reiterating the importance of finding the domain of a function *before* simplifying, as evidenced by the function I in the previous example. Even though the formula $I(x)$ simplifies to

⁵Do you remember why? Consider squaring both sides to 'solve' $\sqrt{t+1} = -2$.

⁶More precisely, the fraction $\frac{0}{0}$ is an 'indeterminant form'. Calculus is required tame such beasts.

$3x$, it would be inaccurate to write $I(x) = 3x$ without adding the stipulation that $x \neq 0$. It would be analogous to not reporting taxable income or some other sin of omission.

1.4.1 MODELING WITH FUNCTIONS

The importance of Mathematics to our society lies in its value to approximate, or **model** real-world phenomenon. Whether it be used to predict the high temperature on a given day, determine the hours of daylight on a given day, or predict population trends of various and sundry real and mythical beasts,⁷ Mathematics is second only to literacy in the importance humanity's development.⁸

It is important to keep in mind that anytime Mathematics is used to approximate reality, there are always limitations to the model. For example, suppose grapes are on sale at the local market for \$1.50 per pound. Then one pound of grapes costs \$1.50, two pounds of grapes cost \$3.00, and so forth. Suppose we want to develop a formula which relates the cost of buying grapes to the amount of grapes being purchased. Since these two quantities vary from situation to situation, we assign them variables. Let c denote the cost of the grapes and let g denote the amount of grapes purchased. To find the cost c of the grapes, we multiply the amount of grapes g by the price \$1.50 dollars per pound to get

$$c = 1.5g$$

In order for the units to be correct in the formula, g must be measured in *pounds* of grapes in which case the computed value of c is measured in *dollars*. Since we're interested in finding the cost c given an amount g , we think of g as the independent variable and c as the dependent variable. Using the language of function notation, we write

$$c(g) = 1.5g$$

where g is the amount of grapes purchased (in pounds) and $c(g)$ is the cost (in dollars). For example, $c(5)$ represents the cost, in dollars, to purchase 5 pounds of grapes. In this case, $c(5) = 1.5(5) = 7.5$, so it would cost \$7.50. If, on the other hand, we wanted to find the *amount* of grapes we can purchase for \$5, we would need to set $c(g) = 5$ and solve for g . In this case, $c(g) = 1.5g$, so solving $c(g) = 5$ is equivalent to solving $1.5g = 5$. Doing so gives $g = \frac{5}{1.5} = 3.\bar{3}$. This means we can purchase exactly $3.\bar{3}$ pounds of grapes for \$5. Of course, you would be hard-pressed to buy exactly $3.\bar{3}$ pounds of grapes,⁹ and this leads us to our next topic of discussion, the **applied domain**¹⁰ of a function.

Even though, mathematically, $c(g) = 1.5g$ has no domain restrictions (there are no denominators and no even-indexed radicals), there are certain values of g that don't make any physical sense. For example, $g = -1$ corresponds to 'purchasing' -1 pounds of grapes.¹¹ Also, unless the 'local market' mentioned is the State of California (or some other exporter of grapes), it also doesn't make much sense for $g = 500,000,000$, either. So the reality of the situation limits what g can be, and

⁷See Sections 2.5, 9.1, and 6.5, respectively.

⁸In Carl's humble opinion, of course . . .

⁹You could get close... within a certain specified margin of error, perhaps.

¹⁰or, 'explicit domain'

¹¹Maybe this means *returning* a pound of grapes?

these limits determine the applied domain of g . Typically, an applied domain is stated explicitly. In this case, it would be common to see something like $c(g) = 1.5g$, $0 \leq g \leq 100$, meaning the number of pounds of grapes purchased is limited from 0 up to 100. The upper bound here, 100 may represent the inventory of the market, or some other limit as set by local policy or law. Even with this restriction, our model has its limitations. As we saw above, it is virtually impossible to buy exactly $3.\bar{3}$ pounds of grapes so that our cost is exactly \$5. In this case, being sensible shoppers, we would most likely ‘round down’ and purchase 3 pounds of grapes or however close the market scale can read to $3.\bar{3}$ without being over. It is time for a more sophisticated example.

Example 1.4.4. The height h in feet of a model rocket above the ground t seconds after lift-off is given by

$$h(t) = \begin{cases} -5t^2 + 100t, & \text{if } 0 \leq t \leq 20 \\ 0, & \text{if } t > 20 \end{cases}$$

1. Find and interpret $h(10)$ and $h(60)$.
2. Solve $h(t) = 375$ and interpret your answers.

Solution.

1. We first note that the independent variable here is t , chosen because it represents time. Secondly, the function is broken up into two rules: one formula for values of t between 0 and 20 inclusive, and another for values of t greater than 20. Since $t = 10$ satisfies the inequality $0 \leq t \leq 20$, we use the first formula listed, $h(t) = -5t^2 + 100t$, to find $h(10)$. We get $h(10) = -5(10)^2 + 100(10) = 500$. Since t represents the number of seconds since lift-off and $h(t)$ is the height above the ground in feet, the equation $h(10) = 500$ means that 10 seconds after lift-off, the model rocket is 500 feet above the ground. To find $h(60)$, we note that $t = 60$ satisfies $t > 20$, so we use the rule $h(t) = 0$. This function returns a value of 0 regardless of what value is substituted in for t , so $h(60) = 0$. This means that 60 seconds after lift-off, the rocket is 0 feet above the ground; in other words, a minute after lift-off, the rocket has already returned to Earth.
2. Since the function h is defined in pieces, we need to solve $h(t) = 375$ in pieces. For $0 \leq t \leq 20$, $h(t) = -5t^2 + 100t$, so for these values of t , we solve $-5t^2 + 100t = 375$. Rearranging terms, we get $5t^2 - 100t + 375 = 0$, and factoring gives $5(t - 5)(t - 15) = 0$. Our answers are $t = 5$ and $t = 15$, and since both of these values of t lie between 0 and 20, we keep both solutions. For $t > 20$, $h(t) = 0$, and in this case, there are no solutions to $0 = 375$. In terms of the model rocket, solving $h(t) = 375$ corresponds to finding when, if ever, the rocket reaches 375 feet above the ground. Our two answers, $t = 5$ and $t = 15$ correspond to the rocket reaching this altitude *twice* – once 5 seconds after launch, and again 15 seconds after launch.¹² \square

¹²What goes up ...

The type of function in the previous example is called a **piecewise-defined** function, or ‘piecewise’ function for short. Many real-world phenomena, income tax formulas¹³ for example, are modeled by such functions.

By the way, if we wanted to avoid using a piecewise function in Example 1.4.4, we could have used $h(t) = -5t^2 + 100t$ on the explicit domain $0 \leq t \leq 20$ because after 20 seconds, the rocket is on the ground and stops moving. In many cases, though, piecewise functions are your only choice, so it’s best to understand them well.

Mathematical modeling is not a one-section topic. It’s not even a one-*course* topic as is evidenced by undergraduate and graduate courses in mathematical modeling being offered at many universities. Thus our goal in this section cannot possibly be to tell you the whole story. What we can do is get you started. As we study new classes of functions, we will see what phenomena they can be used to model. In that respect, mathematical modeling cannot be a topic in a book, but rather, must be a theme of the book. For now, we have you explore some very basic models in the Exercises because you need to crawl to walk to run. As we learn more about functions, we’ll help you build your own models and get you on your way to applying Mathematics to your world.

¹³See the [Internal Revenue Service’s website](#)

1.4.2 EXERCISES

In Exercises 1 - 10, find an expression for $f(x)$ and state its domain.

1. f is a function that takes a real number x and performs the following three steps in the order given: (1) multiply by 2; (2) add 3; (3) divide by 4.
2. f is a function that takes a real number x and performs the following three steps in the order given: (1) add 3; (2) multiply by 2; (3) divide by 4.
3. f is a function that takes a real number x and performs the following three steps in the order given: (1) divide by 4; (2) add 3; (3) multiply by 2.
4. f is a function that takes a real number x and performs the following three steps in the order given: (1) multiply by 2; (2) add 3; (3) take the square root.
5. f is a function that takes a real number x and performs the following three steps in the order given: (1) add 3; (2) multiply by 2; (3) take the square root.
6. f is a function that takes a real number x and performs the following three steps in the order given: (1) add 3; (2) take the square root; (3) multiply by 2.
7. f is a function that takes a real number x and performs the following three steps in the order given: (1) take the square root; (2) subtract 13; (3) make the quantity the denominator of a fraction with numerator 4.
8. f is a function that takes a real number x and performs the following three steps in the order given: (1) subtract 13; (2) take the square root; (3) make the quantity the denominator of a fraction with numerator 4.
9. f is a function that takes a real number x and performs the following three steps in the order given: (1) take the square root; (2) make the quantity the denominator of a fraction with numerator 4; (3) subtract 13.
10. f is a function that takes a real number x and performs the following three steps in the order given: (1) make the quantity the denominator of a fraction with numerator 4; (2) take the square root; (3) subtract 13.

In Exercises 11 - 18, use the given function f to find and simplify the following:

- $f(3)$
- $f(-1)$
- $f\left(\frac{3}{2}\right)$
- $f(4x)$
- $4f(x)$
- $f(-x)$
- $f(x - 4)$
- $f(x) - 4$
- $f(x^2)$

11. $f(x) = 2x + 1$

12. $f(x) = 3 - 4x$

13. $f(x) = 2 - x^2$

14. $f(x) = x^2 - 3x + 2$

15. $f(x) = \frac{x}{x-1}$

16. $f(x) = \frac{2}{x^3}$

17. $f(x) = 6$

18. $f(x) = 0$

In Exercises 19 - 26, use the given function f to find and simplify the following:

• $f(2)$

• $f(-2)$

• $f(2a)$

• $2f(a)$

• $f(a+2)$

• $f(a) + f(2)$

• $f\left(\frac{2}{a}\right)$

• $\frac{f(a)}{2}$

• $f(a+h)$

19. $f(x) = 2x - 5$

20. $f(x) = 5 - 2x$

21. $f(x) = 2x^2 - 1$

22. $f(x) = 3x^2 + 3x - 2$

23. $f(x) = \sqrt{2x+1}$

24. $f(x) = 117$

25. $f(x) = \frac{x}{2}$

26. $f(x) = \frac{2}{x}$

In Exercises 27 - 34, use the given function f to find $f(0)$ and solve $f(x) = 0$

27. $f(x) = 2x - 1$

28. $f(x) = 3 - \frac{2}{5}x$

29. $f(x) = 2x^2 - 6$

30. $f(x) = x^2 - x - 12$

31. $f(x) = \sqrt{x+4}$

32. $f(x) = \sqrt{1-2x}$

33. $f(x) = \frac{3}{4-x}$

34. $f(x) = \frac{3x^2 - 12x}{4 - x^2}$

35. Let $f(x) = \begin{cases} x+5 & \text{if } x \leq -3 \\ \sqrt{9-x^2} & \text{if } -3 < x \leq 3 \\ -x+5 & \text{if } x > 3 \end{cases}$ Compute the following function values.

(a) $f(-4)$

(b) $f(-3)$

(c) $f(3)$

(d) $f(3.001)$

(e) $f(-3.001)$

(f) $f(2)$

36. Let $f(x) = \begin{cases} x^2 & \text{if } x \leq -1 \\ \sqrt{1-x^2} & \text{if } -1 < x \leq 1 \\ x & \text{if } x > 1 \end{cases}$ Compute the following function values.

(a) $f(4)$

(b) $f(-3)$

(c) $f(1)$

(d) $f(0)$

(e) $f(-1)$

(f) $f(-0.999)$

In Exercises 37 - 62, find the (implied) domain of the function.

37. $f(x) = x^4 - 13x^3 + 56x^2 - 19$

38. $f(x) = x^2 + 4$

39. $f(x) = \frac{x-2}{x+1}$

40. $f(x) = \frac{3x}{x^2+x-2}$

41. $f(x) = \frac{2x}{x^2+3}$

42. $f(x) = \frac{2x}{x^2-3}$

43. $f(x) = \frac{x+4}{x^2-36}$

44. $f(x) = \frac{x-2}{x-2}$

45. $f(x) = \sqrt{3-x}$

46. $f(x) = \sqrt{2x+5}$

47. $f(x) = 9x\sqrt{x+3}$

48. $f(x) = \frac{\sqrt{7-x}}{x^2+1}$

49. $f(x) = \sqrt{6x-2}$

50. $f(x) = \frac{6}{\sqrt{6x-2}}$

51. $f(x) = \sqrt[3]{6x-2}$

52. $f(x) = \frac{6}{4-\sqrt{6x-2}}$

53. $f(x) = \frac{\sqrt{6x-2}}{x^2-36}$

54. $f(x) = \frac{\sqrt[3]{6x-2}}{x^2+36}$

55. $s(t) = \frac{t}{t-8}$

56. $Q(r) = \frac{\sqrt{r}}{r-8}$

57. $b(\theta) = \frac{\theta}{\sqrt{\theta-8}}$

58. $A(x) = \sqrt{x-7} + \sqrt{9-x}$

59. $\alpha(y) = \sqrt[3]{\frac{y}{y-8}}$

60. $g(v) = \frac{1}{4-\frac{1}{v^2}}$

61. $T(t) = \frac{\sqrt{t}-8}{5-t}$

62. $u(w) = \frac{w-8}{5-\sqrt{w}}$

63. The area A enclosed by a square, in square inches, is a function of the length of one of its sides x , when measured in inches. This relation is expressed by the formula $A(x) = x^2$ for $x > 0$. Find $A(3)$ and solve $A(x) = 36$. Interpret your answers to each. Why is x restricted to $x > 0$?
64. The area A enclosed by a circle, in square meters, is a function of its radius r , when measured in meters. This relation is expressed by the formula $A(r) = \pi r^2$ for $r > 0$. Find $A(2)$ and solve $A(r) = 16\pi$. Interpret your answers to each. Why is r restricted to $r > 0$?
65. The volume V enclosed by a cube, in cubic centimeters, is a function of the length of one of its sides x , when measured in centimeters. This relation is expressed by the formula $V(x) = x^3$ for $x > 0$. Find $V(5)$ and solve $V(x) = 27$. Interpret your answers to each. Why is x restricted to $x > 0$?
66. The volume V enclosed by a sphere, in cubic feet, is a function of the radius of the sphere r , when measured in feet. This relation is expressed by the formula $V(r) = \frac{4\pi}{3}r^3$ for $r > 0$. Find $V(3)$ and solve $V(r) = \frac{32\pi}{3}$. Interpret your answers to each. Why is r restricted to $r > 0$?
67. The height of an object dropped from the roof of an eight story building is modeled by: $h(t) = -16t^2 + 64$, $0 \leq t \leq 2$. Here, h is the height of the object off the ground, in feet, t seconds after the object is dropped. Find $h(0)$ and solve $h(t) = 0$. Interpret your answers to each. Why is t restricted to $0 \leq t \leq 2$?
68. The temperature T in degrees Fahrenheit t hours after 6 AM is given by $T(t) = -\frac{1}{2}t^2 + 8t + 3$ for $0 \leq t \leq 12$. Find and interpret $T(0)$, $T(6)$ and $T(12)$.
69. The function $C(x) = x^2 - 10x + 27$ models the cost, in *hundreds* of dollars, to produce x *thousand* pens. Find and interpret $C(0)$, $C(2)$ and $C(5)$.
70. Using data from the [Bureau of Transportation Statistics](#), the average fuel economy F in miles per gallon for passenger cars in the US can be modeled by $F(t) = -0.0076t^2 + 0.45t + 16$, $0 \leq t \leq 28$, where t is the number of years since 1980. Use your calculator to find $F(0)$, $F(14)$ and $F(28)$. Round your answers to two decimal places and interpret your answers to each.
71. The population of Sasquatch in Portage County can be modeled by the function $P(t) = \frac{150t}{t+15}$, where t represents the number of years since 1803. Find and interpret $P(0)$ and $P(205)$. Discuss with your classmates what the applied domain and range of P should be.
72. For n copies of the book *Me and my Sasquatch*, a print on-demand company charges $C(n)$ dollars, where $C(n)$ is determined by the formula

$$C(n) = \begin{cases} 15n & \text{if } 1 \leq n \leq 25 \\ 13.50n & \text{if } 25 < n \leq 50 \\ 12n & \text{if } n > 50 \end{cases}$$

- (a) Find and interpret $C(20)$.

- (b) How much does it cost to order 50 copies of the book? What about 51 copies?
- (c) Your answer to 72b should get you thinking. Suppose a bookstore estimates it will sell 50 copies of the book. How many books can, in fact, be ordered for the same price as those 50 copies? (Round your answer to a whole number of books.)

73. An on-line comic book retailer charges shipping costs according to the following formula

$$S(n) = \begin{cases} 1.5n + 2.5 & \text{if } 1 \leq n \leq 14 \\ 0 & \text{if } n \geq 15 \end{cases}$$

where n is the number of comic books purchased and $S(n)$ is the shipping cost in dollars.

- (a) What is the cost to ship 10 comic books?
- (b) What is the significance of the formula $S(n) = 0$ for $n \geq 15$?

74. The cost C (in dollars) to talk m minutes a month on a mobile phone plan is modeled by

$$C(m) = \begin{cases} 25 & \text{if } 0 \leq m \leq 1000 \\ 25 + 0.1(m - 1000) & \text{if } m > 1000 \end{cases}$$

- (a) How much does it cost to talk 750 minutes per month with this plan?
- (b) How much does it cost to talk 20 hours a month with this plan?
- (c) Explain the terms of the plan verbally.

75. In Section 1.1.1 we defined the set of **integers** as $\mathbb{Z} = \{\dots, -3, -2, -1, 0, 1, 2, 3, \dots\}$.¹⁴ The **greatest integer of x** , denoted by $\lfloor x \rfloor$, is defined to be the largest integer k with $k \leq x$.

- (a) Find $\lfloor 0.785 \rfloor$, $\lfloor 117 \rfloor$, $\lfloor -2.001 \rfloor$, and $\lfloor \pi + 6 \rfloor$
- (b) Discuss with your classmates how $\lfloor x \rfloor$ may be described as a piecewise defined function.
HINT: There are infinitely many pieces!
- (c) Is $\lfloor a + b \rfloor = \lfloor a \rfloor + \lfloor b \rfloor$ always true? What if a or b is an integer? Test some values, make a conjecture, and explain your result.

76. We have through our examples tried to convince you that, in general, $f(a + b) \neq f(a) + f(b)$. It has been our experience that students refuse to believe us so we'll try again with a different approach. With the help of your classmates, find a function f for which the following properties are always true.

- (a) $f(0) = f(-1 + 1) = f(-1) + f(1)$

¹⁴The use of the letter \mathbb{Z} for the integers is ostensibly because the German word *zahlen* means 'to count.'

(b) $f(5) = f(2 + 3) = f(2) + f(3)$

(c) $f(-6) = f(0 - 6) = f(0) - f(6)$

(d) $f(a + b) = f(a) + f(b)$ regardless of what two numbers we give you for a and b .

How many functions did you find that failed to satisfy the conditions above? Did $f(x) = x^2$ work? What about $f(x) = \sqrt{x}$ or $f(x) = 3x + 7$ or $f(x) = \frac{1}{x}$? Did you find an attribute common to those functions that did succeed? You should have, because there is only one extremely special family of functions that actually works here. Thus we return to our previous statement, **in general**, $f(a + b) \neq f(a) + f(b)$.

1.4.3 ANSWERS

1. $f(x) = \frac{2x+3}{4}$
Domain: $(-\infty, \infty)$

2. $f(x) = \frac{2(x+3)}{4} = \frac{x+3}{2}$
Domain: $(-\infty, \infty)$

3. $f(x) = 2\left(\frac{x}{4} + 3\right) = \frac{1}{2}x + 6$
Domain: $(-\infty, \infty)$

4. $f(x) = \sqrt{2x+3}$
Domain: $[-\frac{3}{2}, \infty)$

5. $f(x) = \sqrt{2(x+3)} = \sqrt{2x+6}$
Domain: $[-3, \infty)$

6. $f(x) = 2\sqrt{x+3}$
Domain: $[-3, \infty)$

7. $f(x) = \frac{4}{\sqrt{x-13}}$
Domain: $[0, 169) \cup (169, \infty)$

8. $f(x) = \frac{4}{\sqrt{x-13}}$
Domain: $(13, \infty)$

9. $f(x) = \frac{4}{\sqrt{x}} - 13$
Domain: $(0, \infty)$

10. $f(x) = \sqrt{\frac{4}{x}} - 13 = \frac{2}{\sqrt{x}} - 13$
Domain: $(0, \infty)$

11. For $f(x) = 2x + 1$

• $f(3) = 7$

• $f(-1) = -1$

• $f\left(\frac{3}{2}\right) = 4$

• $f(4x) = 8x + 1$

• $4f(x) = 8x + 4$

• $f(-x) = -2x + 1$

• $f(x-4) = 2x - 7$

• $f(x) - 4 = 2x - 3$

• $f(x^2) = 2x^2 + 1$

12. For $f(x) = 3 - 4x$

• $f(3) = -9$

• $f(-1) = 7$

• $f\left(\frac{3}{2}\right) = -3$

• $f(4x) = 3 - 16x$

• $4f(x) = 12 - 16x$

• $f(-x) = 4x + 3$

• $f(x-4) = 19 - 4x$

• $f(x) - 4 = -4x - 1$

• $f(x^2) = 3 - 4x^2$

13. For $f(x) = 2 - x^2$

- $f(3) = -7$
- $f(4x) = 2 - 16x^2$
- $f(x-4) = -x^2 + 8x - 14$
- $f(-1) = 1$
- $4f(x) = 8 - 4x^2$
- $f(x) - 4 = -x^2 - 2$
- $f\left(\frac{3}{2}\right) = -\frac{1}{4}$
- $f(-x) = 2 - x^2$
- $f(x^2) = 2 - x^4$

14. For $f(x) = x^2 - 3x + 2$

- $f(3) = 2$
- $f(4x) = 16x^2 - 12x + 2$
- $f(x-4) = x^2 - 11x + 30$
- $f(-1) = 6$
- $4f(x) = 4x^2 - 12x + 8$
- $f(x) - 4 = x^2 - 3x - 2$
- $f\left(\frac{3}{2}\right) = -\frac{1}{4}$
- $f(-x) = x^2 + 3x + 2$
- $f(x^2) = x^4 - 3x^2 + 2$

15. For $f(x) = \frac{x}{x-1}$

- $f(3) = \frac{3}{2}$
- $f(4x) = \frac{4x}{4x-1}$
- $f(x-4) = \frac{x-4}{x-5}$
- $f(-1) = \frac{1}{2}$
- $4f(x) = \frac{4x}{x-1}$
- $f(x) - 4 = \frac{x}{x-1} - 4 = \frac{4-3x}{x-1}$
- $f\left(\frac{3}{2}\right) = 3$
- $f(-x) = \frac{x}{x+1}$
- $f(x^2) = \frac{x^2}{x^2-1}$

16. For $f(x) = \frac{2}{x^3}$

- $f(3) = \frac{2}{27}$
- $f(4x) = \frac{1}{32x^3}$
- $f(x-4) = \frac{2}{(x-4)^3} = \frac{2}{x^3 - 12x^2 + 48x - 64}$
- $f(-1) = -2$
- $4f(x) = \frac{8}{x^3}$
- $f(x) - 4 = \frac{2}{x^3} - 4 = \frac{2-4x^3}{x^3}$
- $f\left(\frac{3}{2}\right) = \frac{16}{27}$
- $f(-x) = -\frac{2}{x^3}$
- $f(x^2) = \frac{2}{x^6}$

17. For $f(x) = 6$

- $f(3) = 6$
- $f(4x) = 6$
- $f(x-4) = 6$
- $f(-1) = 6$
- $4f(x) = 24$
- $f(x) - 4 = 2$
- $f\left(\frac{3}{2}\right) = 6$
- $f(-x) = 6$
- $f(x^2) = 6$

18. For $f(x) = 0$

• $f(3) = 0$

• $f(-1) = 0$

• $f\left(\frac{3}{2}\right) = 0$

• $f(4x) = 0$

• $4f(x) = 0$

• $f(-x) = 0$

• $f(x - 4) = 0$

• $f(x) - 4 = -4$

• $f(x^2) = 0$

19. For $f(x) = 2x - 5$

• $f(2) = -1$

• $f(-2) = -9$

• $f(2a) = 4a - 5$

• $2f(a) = 4a - 10$

• $f(a + 2) = 2a - 1$

• $f(a) + f(2) = 2a - 6$

• $f\left(\frac{2}{a}\right) = \frac{4}{a} - 5$
 $= \frac{4-5a}{a}$

• $\frac{f(a)}{2} = \frac{2a-5}{2}$

• $f(a + h) = 2a + 2h - 5$

20. For $f(x) = 5 - 2x$

• $f(2) = 1$

• $f(-2) = 9$

• $f(2a) = 5 - 4a$

• $2f(a) = 10 - 4a$

• $f(a + 2) = 1 - 2a$

• $f(a) + f(2) = 6 - 2a$

• $f\left(\frac{2}{a}\right) = 5 - \frac{4}{a}$
 $= \frac{5a-4}{a}$

• $\frac{f(a)}{2} = \frac{5-2a}{2}$

• $f(a + h) = 5 - 2a - 2h$

21. For $f(x) = 2x^2 - 1$

• $f(2) = 7$

• $f(-2) = 7$

• $f(2a) = 8a^2 - 1$

• $2f(a) = 4a^2 - 2$

• $f(a + 2) = 2a^2 + 8a + 7$

• $f(a) + f(2) = 2a^2 + 6$

• $f\left(\frac{2}{a}\right) = \frac{8}{a^2} - 1$
 $= \frac{8-a^2}{a^2}$

• $\frac{f(a)}{2} = \frac{2a^2-1}{2}$

• $f(a + h) = 2a^2 + 4ah + 2h^2 - 1$

22. For $f(x) = 3x^2 + 3x - 2$

- $f(2) = 16$
- $f(-2) = 4$
- $f(2a) = 12a^2 + 6a - 2$
- $2f(a) = 6a^2 + 6a - 4$
- $f(a+2) = 3a^2 + 15a + 16$
- $f(a) + f(2) = 3a^2 + 3a + 14$
- $f\left(\frac{2}{a}\right) = \frac{12}{a^2} + \frac{6}{a} - 2$
- $\frac{f(a)}{2} = \frac{3a^2 + 3a - 2}{2}$
- $f(a+h) = 3a^2 + 6ah + 3h^2 + 3a + 3h - 2$
- $= \frac{12 + 6a - 2a^2}{a^2}$

23. For $f(x) = \sqrt{2x+1}$

- $f(2) = \sqrt{5}$
- $f(-2)$ is not real
- $f(2a) = \sqrt{4a+1}$
- $2f(a) = 2\sqrt{2a+1}$
- $f(a+2) = \sqrt{2a+5}$
- $f(a) + f(2) = \sqrt{2a+1} + \sqrt{5}$
- $f\left(\frac{2}{a}\right) = \sqrt{\frac{4}{a}+1}$
- $\frac{f(a)}{2} = \frac{\sqrt{2a+1}}{2}$
- $f(a+h) = \sqrt{2a+2h+1}$
- $= \sqrt{\frac{a+4}{a}}$

24. For $f(x) = 117$

- $f(2) = 117$
- $f(-2) = 117$
- $f(2a) = 117$
- $2f(a) = 234$
- $f(a+2) = 117$
- $f(a) + f(2) = 234$
- $f\left(\frac{2}{a}\right) = 117$
- $\frac{f(a)}{2} = \frac{117}{2}$
- $f(a+h) = 117$

25. For $f(x) = \frac{x}{2}$

- $f(2) = 1$
- $f(-2) = -1$
- $f(2a) = a$
- $2f(a) = a$
- $f(a+2) = \frac{a+2}{2}$
- $f(a) + f(2) = \frac{a}{2} + 1$
- $f\left(\frac{2}{a}\right) = \frac{1}{a}$
- $\frac{f(a)}{2} = \frac{a}{4}$
- $f(a+h) = \frac{a+h}{2}$
- $= \frac{a+2}{2}$

26. For $f(x) = \frac{2}{x}$

• $f(2) = 1$

• $f(-2) = -1$

• $f(2a) = \frac{1}{a}$

• $2f(a) = \frac{4}{a}$

• $f(a+2) = \frac{2}{a+2}$

• $f(a) + f(2) = \frac{2}{a} + 1$
 $= \frac{a+2}{2}$

• $f\left(\frac{2}{a}\right) = a$

• $\frac{f(a)}{2} = \frac{1}{a}$

• $f(a+h) = \frac{2}{a+h}$

27. For $f(x) = 2x - 1$, $f(0) = -1$ and $f(x) = 0$ when $x = \frac{1}{2}$

28. For $f(x) = 3 - \frac{2}{5}x$, $f(0) = 3$ and $f(x) = 0$ when $x = \frac{15}{2}$

29. For $f(x) = 2x^2 - 6$, $f(0) = -6$ and $f(x) = 0$ when $x = \pm\sqrt{3}$

30. For $f(x) = x^2 - x - 12$, $f(0) = -12$ and $f(x) = 0$ when $x = -3$ or $x = 4$

31. For $f(x) = \sqrt{x+4}$, $f(0) = 2$ and $f(x) = 0$ when $x = -4$

32. For $f(x) = \sqrt{1-2x}$, $f(0) = 1$ and $f(x) = 0$ when $x = \frac{1}{2}$

33. For $f(x) = \frac{3}{4-x}$, $f(0) = \frac{3}{4}$ and $f(x)$ is never equal to 0

34. For $f(x) = \frac{3x^2-12x}{4-x^2}$, $f(0) = 0$ and $f(x) = 0$ when $x = 0$ or $x = 4$

35. (a) $f(-4) = 1$

(b) $f(-3) = 2$

(c) $f(3) = 0$

(d) $f(3.001) = 1.999$

(e) $f(-3.001) = 1.999$

(f) $f(2) = \sqrt{5}$

36. (a) $f(4) = 4$

(b) $f(-3) = 9$

(c) $f(1) = 0$

(d) $f(0) = 1$

(e) $f(-1) = 1$

(f) $f(-0.999) \approx 0.0447$

37. $(-\infty, \infty)$

38. $(-\infty, \infty)$

39. $(-\infty, -1) \cup (-1, \infty)$

40. $(-\infty, -2) \cup (-2, 1) \cup (1, \infty)$

41. $(-\infty, \infty)$

42. $(-\infty, -\sqrt{3}) \cup (-\sqrt{3}, \sqrt{3}) \cup (\sqrt{3}, \infty)$

43. $(-\infty, -6) \cup (-6, 6) \cup (6, \infty)$

44. $(-\infty, 2) \cup (2, \infty)$

45. $(-\infty, 3]$

46. $[-\frac{5}{2}, \infty)$

47. $[-3, \infty)$
48. $(-\infty, 7]$
49. $[\frac{1}{3}, \infty)$
50. $(\frac{1}{3}, \infty)$
51. $(-\infty, \infty)$
52. $[\frac{1}{3}, 3) \cup (3, \infty)$
53. $[\frac{1}{3}, 6) \cup (6, \infty)$
54. $(-\infty, \infty)$
55. $(-\infty, 8) \cup (8, \infty)$
56. $[0, 8) \cup (8, \infty)$
57. $(8, \infty)$
58. $[7, 9]$
59. $(-\infty, 8) \cup (8, \infty)$
60. $(-\infty, -\frac{1}{2}) \cup (-\frac{1}{2}, 0) \cup (0, \frac{1}{2}) \cup (\frac{1}{2}, \infty)$
61. $[0, 5) \cup (5, \infty)$
62. $[0, 25) \cup (25, \infty)$
63. $A(3) = 9$, so the area enclosed by a square with a side of length 3 inches is 9 square inches. The solutions to $A(x) = 36$ are $x = \pm 6$. Since x is restricted to $x > 0$, we only keep $x = 6$. This means for the area enclosed by the square to be 36 square inches, the length of the side needs to be 6 inches. Since x represents a length, $x > 0$.
64. $A(2) = 4\pi$, so the area enclosed by a circle with radius 2 meters is 4π square meters. The solutions to $A(r) = 16\pi$ are $r = \pm 4$. Since r is restricted to $r > 0$, we only keep $r = 4$. This means for the area enclosed by the circle to be 16π square meters, the radius needs to be 4 meters. Since r represents a radius (length), $r > 0$.
65. $V(5) = 125$, so the volume enclosed by a cube with a side of length 5 centimeters is 125 cubic centimeters. The solution to $V(x) = 27$ is $x = 3$. This means for the volume enclosed by the cube to be 27 cubic centimeters, the length of the side needs to be 3 centimeters. Since x represents a length, $x > 0$.
66. $V(3) = 36\pi$, so the volume enclosed by a sphere with radius 3 feet is 36π cubic feet. The solution to $V(r) = \frac{32\pi}{3}$ is $r = 2$. This means for the volume enclosed by the sphere to be $\frac{32\pi}{3}$ cubic feet, the radius needs to be 2 feet. Since r represents a radius (length), $r > 0$.
67. $h(0) = 64$, so at the moment the object is dropped off the building, the object is 64 feet off of the ground. The solutions to $h(t) = 0$ are $t = \pm 2$. Since we restrict $0 \leq t \leq 2$, we only keep $t = 2$. This means 2 seconds after the object is dropped off the building, it is 0 feet off the ground. Said differently, the object hits the ground after 2 seconds. The restriction $0 \leq t \leq 2$ restricts the time to be between the moment the object is released and the moment it hits the ground.
68. $T(0) = 3$, so at 6 AM (0 hours after 6 AM), it is 3° Fahrenheit. $T(6) = 33$, so at noon (6 hours after 6 AM), the temperature is 33° Fahrenheit. $T(12) = 27$, so at 6 PM (12 hours after 6 AM), it is 27° Fahrenheit.

69. $C(0) = 27$, so to make 0 pens, it costs¹⁵ \$2700. $C(2) = 11$, so to make 2000 pens, it costs \$1100. $C(5) = 2$, so to make 5000 pens, it costs \$2000.
70. $F(0) = 16.00$, so in 1980 (0 years after 1980), the average fuel economy of passenger cars in the US was 16.00 miles per gallon. $F(14) = 20.81$, so in 1994 (14 years after 1980), the average fuel economy of passenger cars in the US was 20.81 miles per gallon. $F(28) = 22.64$, so in 2008 (28 years after 1980), the average fuel economy of passenger cars in the US was 22.64 miles per gallon.
71. $P(0) = 0$ which means in 1803 (0 years after 1803), there are no Sasquatch in Portage County. $P(205) = \frac{3075}{22} \approx 139.77$, so in 2008 (205 years after 1803), there were between 139 and 140 Sasquatch in Portage County.
72. (a) $C(20) = 300$. It costs \$300 for 20 copies of the book.
(b) $C(50) = 675$, so it costs \$675 for 50 copies of the book. $C(51) = 612$, so it costs \$612 for 51 copies of the book.
(c) 56 books.
73. (a) $S(10) = 17.5$, so it costs \$17.50 to ship 10 comic books.
(b) There is free shipping on orders of 15 or more comic books.
74. (a) $C(750) = 25$, so it costs \$25 to talk 750 minutes per month with this plan.
(b) Since 20 hours = 1200 minutes, we substitute $m = 1200$ and get $C(1200) = 45$. It costs \$45 to talk 20 hours per month with this plan.
(c) It costs \$25 for up to 1000 minutes and 10 cents per minute for each minute over 1000 minutes.
75. (a) $\lfloor 0.785 \rfloor = 0$, $\lfloor 117 \rfloor = 117$, $\lfloor -2.001 \rfloor = -3$, and $\lfloor \pi + 6 \rfloor = 9$

¹⁵This is called the ‘fixed’ or ‘start-up’ cost. We’ll revisit this concept on page 216.

1.5 FUNCTION ARITHMETIC

In the previous section we used the newly defined function notation to make sense of expressions such as ' $f(x) + 2$ ' and ' $2f(x)$ ' for a given function f . It would seem natural, then, that functions should have their own arithmetic which is consistent with the arithmetic of real numbers. The following definitions allow us to add, subtract, multiply and divide functions using the arithmetic we already know for real numbers.

Function Arithmetic

Suppose f and g are functions and x is in both the domain of f and the domain of g .^a

- The **sum** of f and g , denoted $f + g$, is the function defined by the formula

$$(f + g)(x) = f(x) + g(x)$$

- The **difference** of f and g , denoted $f - g$, is the function defined by the formula

$$(f - g)(x) = f(x) - g(x)$$

- The **product** of f and g , denoted fg , is the function defined by the formula

$$(fg)(x) = f(x)g(x)$$

- The **quotient** of f and g , denoted $\frac{f}{g}$, is the function defined by the formula

$$\left(\frac{f}{g}\right)(x) = \frac{f(x)}{g(x)},$$

provided $g(x) \neq 0$.

^aThus x is an element of the intersection of the two domains.

In other words, to add two functions, we add their outputs; to subtract two functions, we subtract their outputs, and so on. Note that while the formula $(f + g)(x) = f(x) + g(x)$ looks suspiciously like some kind of distributive property, it is nothing of the sort; the addition on the left hand side of the equation is *function* addition, and we are using this equation to *define* the output of the new function $f + g$ as the sum of the real number outputs from f and g .

Example 1.5.1. Let $f(x) = 6x^2 - 2x$ and $g(x) = 3 - \frac{1}{x}$.

1. Find $(f + g)(-1)$
2. Find $(fg)(2)$
3. Find the domain of $g - f$ then find and simplify a formula for $(g - f)(x)$.

4. Find the domain of $\left(\frac{g}{f}\right)$ then find and simplify a formula for $\left(\frac{g}{f}\right)(x)$.

Solution.

1. To find $(f + g)(-1)$ we first find $f(-1) = 8$ and $g(-1) = 4$. By definition, we have that $(f + g)(-1) = f(-1) + g(-1) = 8 + 4 = 12$.
2. To find $(fg)(2)$, we first need $f(2)$ and $g(2)$. Since $f(2) = 20$ and $g(2) = \frac{5}{2}$, our formula yields $(fg)(2) = f(2)g(2) = (20)\left(\frac{5}{2}\right) = 50$.
3. One method to find the domain of $g - f$ is to find the domain of g and of f separately, then find the intersection of these two sets. Owing to the denominator in the expression $g(x) = 3 - \frac{1}{x}$, we get that the domain of g is $(-\infty, 0) \cup (0, \infty)$. Since $f(x) = 6x^2 - 2x$ is valid for all real numbers, we have no further restrictions. Thus the domain of $g - f$ matches the domain of g , namely, $(-\infty, 0) \cup (0, \infty)$.

A second method is to analyze the formula for $(g - f)(x)$ *before simplifying* and look for the usual domain issues. In this case,

$$(g - f)(x) = g(x) - f(x) = \left(3 - \frac{1}{x}\right) - (6x^2 - 2x),$$

so we find, as before, the domain is $(-\infty, 0) \cup (0, \infty)$.

Moving along, we need to simplify a formula for $(g - f)(x)$. In this case, we get common denominators and attempt to reduce the resulting fraction. Doing so, we get

$$\begin{aligned} (g - f)(x) &= g(x) - f(x) \\ &= \left(3 - \frac{1}{x}\right) - (6x^2 - 2x) \\ &= 3 - \frac{1}{x} - 6x^2 + 2x \\ &= \frac{3x}{x} - \frac{1}{x} - \frac{6x^3}{x} + \frac{2x^2}{x} && \text{get common denominators} \\ &= \frac{3x - 1 - 6x^3 - 2x^2}{x} \\ &= \frac{-6x^3 - 2x^2 + 3x - 1}{x} \end{aligned}$$

4. As in the previous example, we have two ways to approach finding the domain of $\frac{g}{f}$. First, we can find the domain of g and f separately, and find the intersection of these two sets. In addition, since $\left(\frac{g}{f}\right)(x) = \frac{g(x)}{f(x)}$, we are introducing a new denominator, namely $f(x)$, so we need to guard against this being 0 as well. Our previous work tells us that the domain of g is $(-\infty, 0) \cup (0, \infty)$ and the domain of f is $(-\infty, \infty)$. Setting $f(x) = 0$ gives $6x^2 - 2x = 0$

or $x = 0, \frac{1}{3}$. As a result, the domain of $\frac{g}{f}$ is all real numbers except $x = 0$ and $x = \frac{1}{3}$, or $(-\infty, 0) \cup (0, \frac{1}{3}) \cup (\frac{1}{3}, \infty)$.

Alternatively, we may proceed as above and analyze the expression $\left(\frac{g}{f}\right)(x) = \frac{g(x)}{f(x)}$ *before* simplifying. In this case,

$$\left(\frac{g}{f}\right)(x) = \frac{g(x)}{f(x)} = \frac{3 - \frac{1}{x}}{6x^2 - 2x}$$

We see immediately from the ‘little’ denominator that $x \neq 0$. To keep the ‘big’ denominator away from 0, we solve $6x^2 - 2x = 0$ and get $x = 0$ or $x = \frac{1}{3}$. Hence, as before, we find the domain of $\frac{g}{f}$ to be $(-\infty, 0) \cup (0, \frac{1}{3}) \cup (\frac{1}{3}, \infty)$.

Next, we find and simplify a formula for $\left(\frac{g}{f}\right)(x)$.

$$\begin{aligned} \left(\frac{g}{f}\right)(x) &= \frac{g(x)}{f(x)} \\ &= \frac{3 - \frac{1}{x}}{6x^2 - 2x} \\ &= \frac{3 - \frac{1}{x}}{6x^2 - 2x} \cdot \frac{x}{x} \quad \text{simplify compound fractions} \\ &= \frac{\left(3 - \frac{1}{x}\right)x}{(6x^2 - 2x)x} \\ &= \frac{3x - 1}{(6x^2 - 2x)x} \\ &= \frac{3x - 1}{2x^2(3x - 1)} \quad \text{factor} \\ &= \frac{\cancel{(3x - 1)}^1}{2x^2\cancel{(3x - 1)}} \quad \text{cancel} \\ &= \frac{1}{2x^2} \end{aligned}$$

□

Please note the importance of finding the domain of a function *before* simplifying its expression. In number 4 in Example 1.5.1 above, had we waited to find the domain of $\frac{g}{f}$ until after simplifying, we’d just have the formula $\frac{1}{2x^2}$ to go by, and we would (incorrectly!) state the domain as $(-\infty, 0) \cup (0, \infty)$, since the other troublesome number, $x = \frac{1}{3}$, was canceled away.¹

¹We’ll see what this means geometrically in Chapter 4.

Next, we turn our attention to the **difference quotient** of a function.

Definition 1.8. Given a function f , the **difference quotient** of f is the expression

$$\frac{f(x+h) - f(x)}{h}$$

We will revisit this concept in Section 2.1, but for now, we use it as a way to practice function notation and function arithmetic. For reasons which will become clear in Calculus, ‘simplifying’ a difference quotient means rewriting it in a form where the ‘ h ’ in the definition of the difference quotient cancels from the denominator. Once that happens, we consider our work to be done.

Example 1.5.2. Find and simplify the difference quotients for the following functions

$$1. f(x) = x^2 - x - 2 \qquad 2. g(x) = \frac{3}{2x+1} \qquad 3. r(x) = \sqrt{x}$$

Solution.

1. To find $f(x+h)$, we replace every occurrence of x in the formula $f(x) = x^2 - x - 2$ with the quantity $(x+h)$ to get

$$\begin{aligned} f(x+h) &= (x+h)^2 - (x+h) - 2 \\ &= x^2 + 2xh + h^2 - x - h - 2. \end{aligned}$$

So the difference quotient is

$$\begin{aligned} \frac{f(x+h) - f(x)}{h} &= \frac{(x^2 + 2xh + h^2 - x - h - 2) - (x^2 - x - 2)}{h} \\ &= \frac{x^2 + 2xh + h^2 - x - h - 2 - x^2 + x + 2}{h} \\ &= \frac{2xh + h^2 - h}{h} \\ &= \frac{h(2x + h - 1)}{h} && \text{factor} \\ &= \frac{\cancel{h}(2x + h - 1)}{\cancel{h}} && \text{cancel} \\ &= 2x + h - 1. \end{aligned}$$

2. To find $g(x + h)$, we replace every occurrence of x in the formula $g(x) = \frac{3}{2x+1}$ with the quantity $(x + h)$ to get

$$\begin{aligned} g(x + h) &= \frac{3}{2(x + h) + 1} \\ &= \frac{3}{2x + 2h + 1}, \end{aligned}$$

which yields

$$\begin{aligned} \frac{g(x + h) - g(x)}{h} &= \frac{\frac{3}{2x + 2h + 1} - \frac{3}{2x + 1}}{h} \\ &= \frac{\frac{3}{2x + 2h + 1} - \frac{3}{2x + 1}}{h} \cdot \frac{(2x + 2h + 1)(2x + 1)}{(2x + 2h + 1)(2x + 1)} \\ &= \frac{3(2x + 1) - 3(2x + 2h + 1)}{h(2x + 2h + 1)(2x + 1)} \\ &= \frac{6x + 3 - 6x - 6h - 3}{h(2x + 2h + 1)(2x + 1)} \\ &= \frac{-6h}{h(2x + 2h + 1)(2x + 1)} \\ &= \frac{-6\cancel{h}}{\cancel{h}(2x + 2h + 1)(2x + 1)} \\ &= \frac{-6}{(2x + 2h + 1)(2x + 1)}. \end{aligned}$$

Since we have managed to cancel the original ‘ h ’ from the denominator, we are done.

3. For $r(x) = \sqrt{x}$, we get $r(x + h) = \sqrt{x + h}$ so the difference quotient is

$$\frac{r(x + h) - r(x)}{h} = \frac{\sqrt{x + h} - \sqrt{x}}{h}$$

In order to cancel the ‘ h ’ from the denominator, we rationalize the *numerator* by multiplying by its conjugate.²

²Rationalizing the *numerator*!? How’s that for a twist!

$$\begin{aligned}
\frac{r(x+h) - r(x)}{h} &= \frac{\sqrt{x+h} - \sqrt{x}}{h} \\
&= \frac{(\sqrt{x+h} - \sqrt{x})}{h} \cdot \frac{(\sqrt{x+h} + \sqrt{x})}{(\sqrt{x+h} + \sqrt{x})} && \text{Multiply by the conjugate.} \\
&= \frac{(\sqrt{x+h})^2 - (\sqrt{x})^2}{h(\sqrt{x+h} + \sqrt{x})} && \text{Difference of Squares.} \\
&= \frac{(x+h) - x}{h(\sqrt{x+h} + \sqrt{x})} \\
&= \frac{h}{h(\sqrt{x+h} + \sqrt{x})} \\
&= \frac{\overset{1}{\cancel{h}}}{\cancel{h}(\sqrt{x+h} + \sqrt{x})} \\
&= \frac{1}{\sqrt{x+h} + \sqrt{x}}
\end{aligned}$$

Since we have removed the original ‘ h ’ from the denominator, we are done. \square

As mentioned before, we will revisit difference quotients in Section 2.1 where we will explain them geometrically. For now, we want to move on to some classic applications of function arithmetic from Economics and for that, we need to think like an entrepreneur.³

Suppose you are a manufacturer making a certain product.⁴ Let x be the **production level**, that is, the number of items produced in a given time period. It is customary to let $C(x)$ denote the function which calculates the total **cost** of producing the x items. The quantity $C(0)$, which represents the cost of producing no items, is called the **fixed** cost, and represents the amount of money required to begin production. Associated with the total cost $C(x)$ is cost per item, or **average cost**, denoted $\bar{C}(x)$ and read ‘ C -bar’ of x . To compute $\bar{C}(x)$, we take the total cost $C(x)$ and divide by the number of items produced x to get

$$\bar{C}(x) = \frac{C(x)}{x}$$

On the retail end, we have the **price** p charged per item. To simplify the dialog and computations in this text, we assume that *the number of items sold equals the number of items produced*. From a

³Not really, but “entrepreneur” is the buzzword of the day and we’re trying to be trendy.

⁴Poorly designed resin Sasquatch statues, for example. Feel free to choose your own entrepreneurial fantasy.

retail perspective, it seems natural to think of the number of items sold, x , as a function of the price charged, p . After all, the retailer can easily adjust the price to sell more product. In the language of functions, x would be the *dependent* variable and p would be the *independent* variable or, using function notation, we have a function $x(p)$. While we will adopt this convention later in the text,⁵ we will hold with tradition at this point and consider the price p as a function of the number of items sold, x . That is, we regard x as the independent variable and p as the dependent variable and speak of the **price-demand** function, $p(x)$. Hence, $p(x)$ returns the price charged per item when x items are produced and sold. Our next function to consider is the **revenue** function, $R(x)$. The function $R(x)$ computes the amount of money collected as a result of selling x items. Since $p(x)$ is the price charged per item, we have $R(x) = xp(x)$. Finally, the **profit** function, $P(x)$ calculates how much money is earned after the costs are paid. That is, $P(x) = (R - C)(x) = R(x) - C(x)$. We summarize all of these functions below.

Summary of Common Economic Functions

Suppose x represents the quantity of items produced and sold.

- The price-demand function $p(x)$ calculates the price per item.
- The revenue function $R(x)$ calculates the total money collected by selling x items at a price $p(x)$, $R(x) = xp(x)$.
- The cost function $C(x)$ calculates the cost to produce x items. The value $C(0)$ is called the fixed cost or start-up cost.
- The average cost function $\bar{C}(x) = \frac{C(x)}{x}$ calculates the cost per item when making x items. Here, we necessarily assume $x > 0$.
- The profit function $P(x)$ calculates the money earned after costs are paid when x items are produced and sold, $P(x) = (R - C)(x) = R(x) - C(x)$.

It is high time for an example.

Example 1.5.3. Let x represent the number of dOpi media players ('dOpis'⁶) produced and sold in a typical week. Suppose the cost, in dollars, to produce x dOpis is given by $C(x) = 100x + 2000$, for $x \geq 0$, and the price, in dollars per dOpi, is given by $p(x) = 450 - 15x$ for $0 \leq x \leq 30$.

1. Find and interpret $C(0)$.
2. Find and interpret $\bar{C}(10)$.
3. Find and interpret $p(0)$ and $p(20)$.
4. Solve $p(x) = 0$ and interpret the result.
5. Find and simplify expressions for the revenue function $R(x)$ and the profit function $P(x)$.
6. Find and interpret $R(0)$ and $P(0)$.
7. Solve $P(x) = 0$ and interpret the result.

⁵See Example 5.2.4 in Section 5.2.

⁶Pronounced 'dopeys'...

Solution.

1. We substitute $x = 0$ into the formula for $C(x)$ and get $C(0) = 100(0) + 2000 = 2000$. This means to produce 0 dOpis, it costs \$2000. In other words, the fixed (or start-up) costs are \$2000. The reader is encouraged to contemplate what sorts of expenses these might be.
2. Since $\bar{C}(x) = \frac{C(x)}{x}$, $\bar{C}(10) = \frac{C(10)}{10} = \frac{3000}{10} = 300$. This means when 10 dOpis are produced, the cost to manufacture them amounts to \$300 per dOpi.
3. Plugging $x = 0$ into the expression for $p(x)$ gives $p(0) = 450 - 15(0) = 450$. This means no dOpis are sold if the price is \$450 per dOpi. On the other hand, $p(20) = 450 - 15(20) = 150$ which means to sell 20 dOpis in a typical week, the price should be set at \$150 per dOpi.
4. Setting $p(x) = 0$ gives $450 - 15x = 0$. Solving gives $x = 30$. This means in order to sell 30 dOpis in a typical week, the price needs to be set to \$0. What's more, this means that even if dOpis were given away for free, the retailer would only be able to move 30 of them.⁷
5. To find the revenue, we compute $R(x) = xp(x) = x(450 - 15x) = 450x - 15x^2$. Since the formula for $p(x)$ is valid only for $0 \leq x \leq 30$, our formula $R(x)$ is also restricted to $0 \leq x \leq 30$. For the profit, $P(x) = (R - C)(x) = R(x) - C(x)$. Using the given formula for $C(x)$ and the derived formula for $R(x)$, we get $P(x) = (450x - 15x^2) - (100x + 2000) = -15x^2 + 350x - 2000$. As before, the validity of this formula is for $0 \leq x \leq 30$ only.
6. We find $R(0) = 0$ which means if no dOpis are sold, we have no revenue, which makes sense. Turning to profit, $P(0) = -2000$ since $P(x) = R(x) - C(x)$ and $P(0) = R(0) - C(0) = -2000$. This means that if no dOpis are sold, more money (\$2000 to be exact!) was put into producing the dOpis than was recouped in sales. In number 1, we found the fixed costs to be \$2000, so it makes sense that if we sell no dOpis, we are out those start-up costs.
7. Setting $P(x) = 0$ gives $-15x^2 + 350x - 2000 = 0$. Factoring gives $-5(x - 10)(3x - 40) = 0$ so $x = 10$ or $x = \frac{40}{3}$. What do these values mean in the context of the problem? Since $P(x) = R(x) - C(x)$, solving $P(x) = 0$ is the same as solving $R(x) = C(x)$. This means that the solutions to $P(x) = 0$ are the production (and sales) figures for which the sales revenue exactly balances the total production costs. These are the so-called '**break even**' points. The solution $x = 10$ means 10 dOpis should be produced (and sold) during the week to recoup the cost of production. For $x = \frac{40}{3} = 13.\bar{3}$, things are a bit more complicated. Even though $x = 13.\bar{3}$ satisfies $0 \leq x \leq 30$, and hence is in the domain of P , it doesn't make sense in the context of this problem to produce a fractional part of a dOpi.⁸ Evaluating $P(13) = 15$ and $P(14) = -40$, we see that producing and selling 13 dOpis per week makes a (slight) profit, whereas producing just one more puts us back into the red. While breaking even is nice, we ultimately would like to find what production level (and price) will result in the largest profit, and we'll do just that ... in Section 2.3. \square

⁷Imagine that! Giving something away for free and hardly anyone taking advantage of it ...

⁸We've seen this sort of thing before in Section 1.4.1.

1.5.1 EXERCISES

In Exercises 1 - 10, use the pair of functions f and g to find the following values if they exist.

- $(f + g)(2)$
- $(f - g)(-1)$
- $(g - f)(1)$
- $(fg)(\frac{1}{2})$
- $(\frac{f}{g})(0)$
- $(\frac{g}{f})(-2)$

1. $f(x) = 3x + 1$ and $g(x) = 4 - x$
2. $f(x) = x^2$ and $g(x) = -2x + 1$
3. $f(x) = x^2 - x$ and $g(x) = 12 - x^2$
4. $f(x) = 2x^3$ and $g(x) = -x^2 - 2x - 3$
5. $f(x) = \sqrt{x + 3}$ and $g(x) = 2x - 1$
6. $f(x) = \sqrt{4 - x}$ and $g(x) = \sqrt{x + 2}$
7. $f(x) = 2x$ and $g(x) = \frac{1}{2x + 1}$
8. $f(x) = x^2$ and $g(x) = \frac{3}{2x - 3}$
9. $f(x) = x^2$ and $g(x) = \frac{1}{x^2}$
10. $f(x) = x^2 + 1$ and $g(x) = \frac{1}{x^2 + 1}$

In Exercises 11 - 20, use the pair of functions f and g to find the domain of the indicated function then find and simplify an expression for it.

- $(f + g)(x)$
 - $(f - g)(x)$
 - $(fg)(x)$
 - $(\frac{f}{g})(x)$
11. $f(x) = 2x + 1$ and $g(x) = x - 2$
 12. $f(x) = 1 - 4x$ and $g(x) = 2x - 1$
 13. $f(x) = x^2$ and $g(x) = 3x - 1$
 14. $f(x) = x^2 - x$ and $g(x) = 7x$
 15. $f(x) = x^2 - 4$ and $g(x) = 3x + 6$
 16. $f(x) = -x^2 + x + 6$ and $g(x) = x^2 - 9$
 17. $f(x) = \frac{x}{2}$ and $g(x) = \frac{2}{x}$
 18. $f(x) = x - 1$ and $g(x) = \frac{1}{x - 1}$
 19. $f(x) = x$ and $g(x) = \sqrt{x + 1}$
 20. $f(x) = \sqrt{x - 5}$ and $g(x) = f(x) = \sqrt{x - 5}$

In Exercises 21 - 45, find and simplify the difference quotient $\frac{f(x + h) - f(x)}{h}$ for the given function.

21. $f(x) = 2x - 5$
22. $f(x) = -3x + 5$
23. $f(x) = 6$
24. $f(x) = 3x^2 - x$
25. $f(x) = -x^2 + 2x - 1$
26. $f(x) = 4x^2$

27. $f(x) = x - x^2$

28. $f(x) = x^3 + 1$

29. $f(x) = mx + b$ where $m \neq 0$

30. $f(x) = ax^2 + bx + c$ where $a \neq 0$

31. $f(x) = \frac{2}{x}$

32. $f(x) = \frac{3}{1-x}$

33. $f(x) = \frac{1}{x^2}$

34. $f(x) = \frac{2}{x+5}$

35. $f(x) = \frac{1}{4x-3}$

36. $f(x) = \frac{3x}{x+1}$

37. $f(x) = \frac{x}{x-9}$

38. $f(x) = \frac{x^2}{2x+1}$

39. $f(x) = \sqrt{x-9}$

40. $f(x) = \sqrt{2x+1}$

41. $f(x) = \sqrt{-4x+5}$

42. $f(x) = \sqrt{4-x}$

43. $f(x) = \sqrt{ax+b}$, where $a \neq 0$.

44. $f(x) = x\sqrt{x}$

45. $f(x) = \sqrt[3]{x}$. **HINT:** $(a-b)(a^2+ab+b^2) = a^3-b^3$

In Exercises 46 - 50, $C(x)$ denotes the cost to produce x items and $p(x)$ denotes the price-demand function in the given economic scenario. In each Exercise, do the following:

- Find and interpret $C(0)$.
 - Find and interpret $\overline{C}(10)$.
 - Find and interpret $p(5)$.
 - Find and simplify $R(x)$.
 - Find and simplify $P(x)$.
 - Solve $P(x) = 0$ and interpret.
46. The cost, in dollars, to produce x "I'd rather be a Sasquatch" T-Shirts is $C(x) = 2x + 26$, $x \geq 0$ and the price-demand function, in dollars per shirt, is $p(x) = 30 - 2x$, $0 \leq x \leq 15$.
47. The cost, in dollars, to produce x bottles of 100% All-Natural Certified Free-Trade Organic Sasquatch Tonic is $C(x) = 10x + 100$, $x \geq 0$ and the price-demand function, in dollars per bottle, is $p(x) = 35 - x$, $0 \leq x \leq 35$.
48. The cost, in cents, to produce x cups of Mountain Thunder Lemonade at Junior's Lemonade Stand is $C(x) = 18x + 240$, $x \geq 0$ and the price-demand function, in cents per cup, is $p(x) = 90 - 3x$, $0 \leq x \leq 30$.
49. The daily cost, in dollars, to produce x Sasquatch Berry Pies $C(x) = 3x + 36$, $x \geq 0$ and the price-demand function, in dollars per pie, is $p(x) = 12 - 0.5x$, $0 \leq x \leq 24$.

50. The monthly cost, in hundreds of dollars, to produce x custom built electric scooters is $C(x) = 20x + 1000$, $x \geq 0$ and the price-demand function, in hundreds of dollars per scooter, is $p(x) = 140 - 2x$, $0 \leq x \leq 70$.

In Exercises 51 - 62, let f be the function defined by

$$f = \{(-3, 4), (-2, 2), (-1, 0), (0, 1), (1, 3), (2, 4), (3, -1)\}$$

and let g be the function defined

$$g = \{(-3, -2), (-2, 0), (-1, -4), (0, 0), (1, -3), (2, 1), (3, 2)\}$$

. Compute the indicated value if it exists.

51. $(f + g)(-3)$

52. $(f - g)(2)$

53. $(fg)(-1)$

54. $(g + f)(1)$

55. $(g - f)(3)$

56. $(gf)(-3)$

57. $\left(\frac{f}{g}\right)(-2)$

58. $\left(\frac{f}{g}\right)(-1)$

59. $\left(\frac{f}{g}\right)(2)$

60. $\left(\frac{g}{f}\right)(-1)$

61. $\left(\frac{g}{f}\right)(3)$

62. $\left(\frac{g}{f}\right)(-3)$

1.5.2 ANSWERS

1. For $f(x) = 3x + 1$ and $g(x) = 4 - x$

$$\begin{array}{lll} \bullet (f + g)(2) = 9 & \bullet (f - g)(-1) = -7 & \bullet (g - f)(1) = -1 \\ \bullet (fg)\left(\frac{1}{2}\right) = \frac{35}{4} & \bullet \left(\frac{f}{g}\right)(0) = \frac{1}{4} & \bullet \left(\frac{g}{f}\right)(-2) = -\frac{6}{5} \end{array}$$

2. For $f(x) = x^2$ and $g(x) = -2x + 1$

$$\begin{array}{lll} \bullet (f + g)(2) = 1 & \bullet (f - g)(-1) = -2 & \bullet (g - f)(1) = -2 \\ \bullet (fg)\left(\frac{1}{2}\right) = 0 & \bullet \left(\frac{f}{g}\right)(0) = 0 & \bullet \left(\frac{g}{f}\right)(-2) = \frac{5}{4} \end{array}$$

3. For $f(x) = x^2 - x$ and $g(x) = 12 - x^2$

$$\begin{array}{lll} \bullet (f + g)(2) = 10 & \bullet (f - g)(-1) = -9 & \bullet (g - f)(1) = 11 \\ \bullet (fg)\left(\frac{1}{2}\right) = -\frac{47}{16} & \bullet \left(\frac{f}{g}\right)(0) = 0 & \bullet \left(\frac{g}{f}\right)(-2) = \frac{4}{3} \end{array}$$

4. For $f(x) = 2x^3$ and $g(x) = -x^2 - 2x - 3$

$$\begin{array}{lll} \bullet (f + g)(2) = 5 & \bullet (f - g)(-1) = 0 & \bullet (g - f)(1) = -8 \\ \bullet (fg)\left(\frac{1}{2}\right) = -\frac{17}{16} & \bullet \left(\frac{f}{g}\right)(0) = 0 & \bullet \left(\frac{g}{f}\right)(-2) = \frac{3}{16} \end{array}$$

5. For $f(x) = \sqrt{x + 3}$ and $g(x) = 2x - 1$

$$\begin{array}{lll} \bullet (f + g)(2) = 3 + \sqrt{5} & \bullet (f - g)(-1) = 3 + \sqrt{2} & \bullet (g - f)(1) = -1 \\ \bullet (fg)\left(\frac{1}{2}\right) = 0 & \bullet \left(\frac{f}{g}\right)(0) = -\sqrt{3} & \bullet \left(\frac{g}{f}\right)(-2) = -5 \end{array}$$

6. For $f(x) = \sqrt{4 - x}$ and $g(x) = \sqrt{x + 2}$

$$\begin{array}{lll} \bullet (f + g)(2) = 2 + \sqrt{2} & \bullet (f - g)(-1) = -1 + \sqrt{5} & \bullet (g - f)(1) = 0 \\ \bullet (fg)\left(\frac{1}{2}\right) = \frac{\sqrt{35}}{2} & \bullet \left(\frac{f}{g}\right)(0) = \sqrt{2} & \bullet \left(\frac{g}{f}\right)(-2) = 0 \end{array}$$

7. For $f(x) = 2x$ and $g(x) = \frac{1}{2x+1}$

- $(f + g)(2) = \frac{21}{5}$
- $(f - g)(-1) = -1$
- $(g - f)(1) = -\frac{5}{3}$
- $(fg)(\frac{1}{2}) = \frac{1}{2}$
- $(\frac{f}{g})(0) = 0$
- $(\frac{g}{f})(-2) = \frac{1}{12}$

8. For $f(x) = x^2$ and $g(x) = \frac{3}{2x-3}$

- $(f + g)(2) = 7$
- $(f - g)(-1) = \frac{8}{5}$
- $(g - f)(1) = -4$
- $(fg)(\frac{1}{2}) = -\frac{3}{8}$
- $(\frac{f}{g})(0) = 0$
- $(\frac{g}{f})(-2) = -\frac{3}{28}$

9. For $f(x) = x^2$ and $g(x) = \frac{1}{x^2}$

- $(f + g)(2) = \frac{17}{4}$
- $(f - g)(-1) = 0$
- $(g - f)(1) = 0$
- $(fg)(\frac{1}{2}) = 1$
- $(\frac{f}{g})(0)$ is undefined.
- $(\frac{g}{f})(-2) = \frac{1}{16}$

10. For $f(x) = x^2 + 1$ and $g(x) = \frac{1}{x^2+1}$

- $(f + g)(2) = \frac{26}{5}$
- $(f - g)(-1) = \frac{3}{2}$
- $(g - f)(1) = -\frac{3}{2}$
- $(fg)(\frac{1}{2}) = 1$
- $(\frac{f}{g})(0) = 1$
- $(\frac{g}{f})(-2) = \frac{1}{25}$

11. For $f(x) = 2x + 1$ and $g(x) = x - 2$

- $(f + g)(x) = 3x - 1$
Domain: $(-\infty, \infty)$
- $(f - g)(x) = x + 3$
Domain: $(-\infty, \infty)$
- $(fg)(x) = 2x^2 - 3x - 2$
Domain: $(-\infty, \infty)$
- $(\frac{f}{g})(x) = \frac{2x+1}{x-2}$
Domain: $(-\infty, 2) \cup (2, \infty)$

12. For $f(x) = 1 - 4x$ and $g(x) = 2x - 1$

- $(f + g)(x) = -2x$
Domain: $(-\infty, \infty)$
- $(f - g)(x) = 2 - 6x$
Domain: $(-\infty, \infty)$
- $(fg)(x) = -8x^2 + 6x - 1$
Domain: $(-\infty, \infty)$
- $(\frac{f}{g})(x) = \frac{1-4x}{2x-1}$
Domain: $(-\infty, \frac{1}{2}) \cup (\frac{1}{2}, \infty)$

13. For $f(x) = x^2$ and $g(x) = 3x - 1$

- $(f + g)(x) = x^2 + 3x - 1$
Domain: $(-\infty, \infty)$

- $(fg)(x) = 3x^3 - x^2$
Domain: $(-\infty, \infty)$

- $(f - g)(x) = x^2 - 3x + 1$
Domain: $(-\infty, \infty)$

- $\left(\frac{f}{g}\right)(x) = \frac{x^2}{3x-1}$
Domain: $(-\infty, \frac{1}{3}) \cup (\frac{1}{3}, \infty)$

14. For $f(x) = x^2 - x$ and $g(x) = 7x$

- $(f + g)(x) = x^2 + 6x$
Domain: $(-\infty, \infty)$

- $(fg)(x) = 7x^3 - 7x^2$
Domain: $(-\infty, \infty)$

- $(f - g)(x) = x^2 - 8x$
Domain: $(-\infty, \infty)$

- $\left(\frac{f}{g}\right)(x) = \frac{x-1}{7}$
Domain: $(-\infty, 0) \cup (0, \infty)$

15. For $f(x) = x^2 - 4$ and $g(x) = 3x + 6$

- $(f + g)(x) = x^2 + 3x + 2$
Domain: $(-\infty, \infty)$

- $(fg)(x) = 3x^3 + 6x^2 - 12x - 24$
Domain: $(-\infty, \infty)$

- $(f - g)(x) = x^2 - 3x - 10$
Domain: $(-\infty, \infty)$

- $\left(\frac{f}{g}\right)(x) = \frac{x-2}{3}$
Domain: $(-\infty, -2) \cup (-2, \infty)$

16. For $f(x) = -x^2 + x + 6$ and $g(x) = x^2 - 9$

- $(f + g)(x) = x - 3$
Domain: $(-\infty, \infty)$

- $(fg)(x) = -x^4 + x^3 + 15x^2 - 9x - 54$
Domain: $(-\infty, \infty)$

- $(f - g)(x) = -2x^2 + x + 15$
Domain: $(-\infty, \infty)$

- $\left(\frac{f}{g}\right)(x) = \frac{-x+2}{x+3}$
Domain: $(-\infty, -3) \cup (-3, 3) \cup (3, \infty)$

17. For $f(x) = \frac{x}{2}$ and $g(x) = \frac{2}{x}$

- $(f + g)(x) = \frac{x^2+4}{2x}$
Domain: $(-\infty, 0) \cup (0, \infty)$

- $(fg)(x) = 1$
Domain: $(-\infty, 0) \cup (0, \infty)$

- $(f - g)(x) = \frac{x^2-4}{2x}$
Domain: $(-\infty, 0) \cup (0, \infty)$

- $\left(\frac{f}{g}\right)(x) = \frac{x^2}{4}$
Domain: $(-\infty, 0) \cup (0, \infty)$

18. For $f(x) = x - 1$ and $g(x) = \frac{1}{x-1}$

- $(f + g)(x) = \frac{x^2 - 2x + 2}{x-1}$
Domain: $(-\infty, 1) \cup (1, \infty)$

- $(fg)(x) = 1$
Domain: $(-\infty, 1) \cup (1, \infty)$

- $(f - g)(x) = \frac{x^2 - 2x}{x-1}$
Domain: $(-\infty, 1) \cup (1, \infty)$

- $\left(\frac{f}{g}\right)(x) = x^2 - 2x + 1$
Domain: $(-\infty, 1) \cup (1, \infty)$

19. For $f(x) = x$ and $g(x) = \sqrt{x+1}$

- $(f + g)(x) = x + \sqrt{x+1}$
Domain: $[-1, \infty)$

- $(fg)(x) = x\sqrt{x+1}$
Domain: $[-1, \infty)$

- $(f - g)(x) = x - \sqrt{x+1}$
Domain: $[-1, \infty)$

- $\left(\frac{f}{g}\right)(x) = \frac{x}{\sqrt{x+1}}$
Domain: $(-1, \infty)$

20. For $f(x) = \sqrt{x-5}$ and $g(x) = f(x) = \sqrt{x-5}$

- $(f + g)(x) = 2\sqrt{x-5}$
Domain: $[5, \infty)$

- $(fg)(x) = x - 5$
Domain: $[5, \infty)$

- $(f - g)(x) = 0$
Domain: $[5, \infty)$

- $\left(\frac{f}{g}\right)(x) = 1$
Domain: $(5, \infty)$

21. 2

22. -3

23. 0

24. $6x + 3h - 1$

25. $-2x - h + 2$

26. $8x + 4h$

27. $-2x - h + 1$

28. $3x^2 + 3xh + h^2$

29. m

30. $2ax + ah + b$

31. $\frac{-2}{x(x+h)}$

32. $\frac{3}{(1-x-h)(1-x)}$

33. $\frac{-(2x+h)}{x^2(x+h)^2}$

34. $\frac{-2}{(x+5)(x+h+5)}$

35. $\frac{-4}{(4x-3)(4x+4h-3)}$

36. $\frac{3}{(x+1)(x+h+1)}$

37.
$$\frac{-9}{(x-9)(x+h-9)}$$

38.
$$\frac{2x^2 + 2xh + 2x + h}{(2x+1)(2x+2h+1)}$$

39.
$$\frac{1}{\sqrt{x+h-9} + \sqrt{x-9}}$$

40.
$$\frac{2}{\sqrt{2x+2h+1} + \sqrt{2x+1}}$$

41.
$$\frac{-4}{\sqrt{-4x-4h+5} + \sqrt{-4x+5}}$$

42.
$$\frac{-1}{\sqrt{4-x-h} + \sqrt{4-x}}$$

43.
$$\frac{a}{\sqrt{ax+ah+b} + \sqrt{ax+b}}$$

44.
$$\frac{3x^2 + 3xh + h^2}{(x+h)^{3/2} + x^{3/2}}$$

45.
$$\frac{1}{(x+h)^{2/3} + (x+h)^{1/3}x^{1/3} + x^{2/3}}$$

46. • $C(0) = 26$, so the fixed costs are \$26.
 • $\bar{C}(10) = 4.6$, so when 10 shirts are produced, the cost per shirt is \$4.60.
 • $p(5) = 20$, so to sell 5 shirts, set the price at \$20 per shirt.
 • $R(x) = -2x^2 + 30x$, $0 \leq x \leq 15$
 • $P(x) = -2x^2 + 28x - 26$, $0 \leq x \leq 15$
 • $P(x) = 0$ when $x = 1$ and $x = 13$. These are the 'break even' points, so selling 1 shirt or 13 shirts will guarantee the revenue earned exactly recoups the cost of production.
47. • $C(0) = 100$, so the fixed costs are \$100.
 • $\bar{C}(10) = 20$, so when 10 bottles of tonic are produced, the cost per bottle is \$20.
 • $p(5) = 30$, so to sell 5 bottles of tonic, set the price at \$30 per bottle.
 • $R(x) = -x^2 + 35x$, $0 \leq x \leq 35$
 • $P(x) = -x^2 + 25x - 100$, $0 \leq x \leq 35$
 • $P(x) = 0$ when $x = 5$ and $x = 20$. These are the 'break even' points, so selling 5 bottles of tonic or 20 bottles of tonic will guarantee the revenue earned exactly recoups the cost of production.
48. • $C(0) = 240$, so the fixed costs are 240¢ or \$2.40.
 • $\bar{C}(10) = 42$, so when 10 cups of lemonade are made, the cost per cup is 42¢.
 • $p(5) = 75$, so to sell 5 cups of lemonade, set the price at 75¢ per cup.
 • $R(x) = -3x^2 + 90x$, $0 \leq x \leq 30$
 • $P(x) = -3x^2 + 72x - 240$, $0 \leq x \leq 30$
 • $P(x) = 0$ when $x = 4$ and $x = 20$. These are the 'break even' points, so selling 4 cups of lemonade or 20 cups of lemonade will guarantee the revenue earned exactly recoups the cost of production.

49. • $C(0) = 36$, so the daily fixed costs are \$36.
 • $\bar{C}(10) = 6.6$, so when 10 pies are made, the cost per pie is \$6.60.
 • $p(5) = 9.5$, so to sell 5 pies a day, set the price at \$9.50 per pie.
 • $R(x) = -0.5x^2 + 12x$, $0 \leq x \leq 24$
 • $P(x) = -0.5x^2 + 9x - 36$, $0 \leq x \leq 24$
 • $P(x) = 0$ when $x = 6$ and $x = 12$. These are the ‘break even’ points, so selling 6 pies or 12 pies a day will guarantee the revenue earned exactly recoups the cost of production.
50. • $C(0) = 1000$, so the monthly fixed costs are 1000 *hundred* dollars, or \$100,000.
 • $\bar{C}(10) = 120$, so when 10 scooters are made, the cost per scooter is 120 hundred dollars, or \$12,000.
 • $p(5) = 130$, so to sell 5 scooters a month, set the price at 130 hundred dollars, or \$13,000 per scooter.
 • $R(x) = -2x^2 + 140x$, $0 \leq x \leq 70$
 • $P(x) = -2x^2 + 120x - 1000$, $0 \leq x \leq 70$
 • $P(x) = 0$ when $x = 10$ and $x = 50$. These are the ‘break even’ points, so selling 10 scooters or 50 scooters a month will guarantee the revenue earned exactly recoups the cost of production.

51. $(f + g)(-3) = 2$

52. $(f - g)(2) = 3$

53. $(fg)(-1) = 0$

54. $(g + f)(1) = 0$

55. $(g - f)(3) = 3$

56. $(gf)(-3) = -8$

57. $\left(\frac{f}{g}\right)(-2)$ does not exist

58. $\left(\frac{f}{g}\right)(-1) = 0$

59. $\left(\frac{f}{g}\right)(2) = 4$

60. $\left(\frac{g}{f}\right)(-1)$ does not exist

61. $\left(\frac{g}{f}\right)(3) = -2$

62. $\left(\frac{g}{f}\right)(-3) = -\frac{1}{2}$

1.6 GRAPHS OF FUNCTIONS

In Section 1.3 we defined a function as a special type of relation; one in which each x -coordinate was matched with only one y -coordinate. We spent most of our time in that section looking at functions graphically because they were, after all, just sets of points in the plane. Then in Section 1.4 we described a function as a process and defined the notation necessary to work with functions algebraically. So now it's time to look at functions graphically again, only this time we'll do so with the notation defined in Section 1.4. We start with what should not be a surprising connection.

The Fundamental Graphing Principle for Functions

The graph of a function f is the set of points which satisfy the equation $y = f(x)$. That is, the point (x, y) is on the graph of f if and only if $y = f(x)$.

Example 1.6.1. Graph $f(x) = x^2 - x - 6$.

Solution. To graph f , we graph the equation $y = f(x)$. To this end, we use the techniques outlined in Section 1.2.1. Specifically, we check for intercepts, test for symmetry, and plot additional points as needed. To find the x -intercepts, we set $y = 0$. Since $y = f(x)$, this means $f(x) = 0$.

$$\begin{aligned} f(x) &= x^2 - x - 6 \\ 0 &= x^2 - x - 6 \\ 0 &= (x - 3)(x + 2) \quad \text{factor} \\ x - 3 = 0 &\text{ or } x + 2 = 0 \\ x &= -2, 3 \end{aligned}$$

So we get $(-2, 0)$ and $(3, 0)$ as x -intercepts. To find the y -intercept, we set $x = 0$. Using function notation, this is the same as finding $f(0)$ and $f(0) = 0^2 - 0 - 6 = -6$. Thus the y -intercept is $(0, -6)$. As far as symmetry is concerned, we can tell from the intercepts that the graph possesses none of the three symmetries discussed thus far. (You should verify this.) We can make a table analogous to the ones we made in Section 1.2.1, plot the points and connect the dots in a somewhat pleasing fashion to get the graph below on the right.

x	$f(x)$	$(x, f(x))$
-3	6	$(-3, 6)$
-2	0	$(-2, 0)$
-1	-4	$(-1, -4)$
0	-6	$(0, -6)$
1	-6	$(1, -6)$
2	-4	$(2, -4)$
3	0	$(3, 0)$
4	6	$(4, 6)$

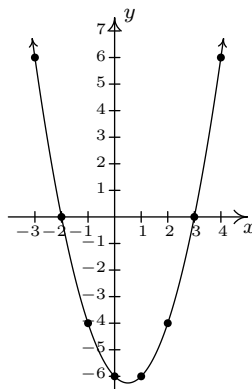

□

Graphing piecewise-defined functions is a bit more of a challenge.

Example 1.6.2. Graph: $f(x) = \begin{cases} 4 - x^2 & \text{if } x < 1 \\ x - 3, & \text{if } x \geq 1 \end{cases}$

Solution. We proceed as before – finding intercepts, testing for symmetry and then plotting additional points as needed. To find the x -intercepts, as before, we set $f(x) = 0$. The twist is that we have two formulas for $f(x)$. For $x < 1$, we use the formula $f(x) = 4 - x^2$. Setting $f(x) = 0$ gives $0 = 4 - x^2$, so that $x = \pm 2$. However, of these two answers, only $x = -2$ fits in the domain $x < 1$ for this piece. This means the only x -intercept for the $x < 1$ region of the x -axis is $(-2, 0)$. For $x \geq 1$, $f(x) = x - 3$. Setting $f(x) = 0$ gives $0 = x - 3$, or $x = 3$. Since $x = 3$ satisfies the inequality $x \geq 1$, we get $(3, 0)$ as another x -intercept. Next, we seek the y -intercept. Notice that $x = 0$ falls in the domain $x < 1$. Thus $f(0) = 4 - 0^2 = 4$ yields the y -intercept $(0, 4)$. As far as symmetry is concerned, you can check that the equation $y = 4 - x^2$ is symmetric about the y -axis; unfortunately, this equation (and its symmetry) is valid only for $x < 1$. You can also verify $y = x - 3$ possesses none of the symmetries discussed in the Section 1.2.1. When plotting additional points, it is important to keep in mind the restrictions on x for each piece of the function. The sticking point for this function is $x = 1$, since this is where the equations change. When $x = 1$, we use the formula $f(x) = x - 3$, so the point on the graph $(1, f(1))$ is $(1, -2)$. However, for all values less than 1, we use the formula $f(x) = 4 - x^2$. As we have discussed earlier in Section 1.2, there is no real number which immediately precedes $x = 1$ on the number line. Thus for the values $x = 0.9$, $x = 0.99$, $x = 0.999$, and so on, we find the corresponding y values using the formula $f(x) = 4 - x^2$. Making a table as before, we see that as the x values sneak up to $x = 1$ in this fashion, the $f(x)$ values inch closer and closer¹ to $4 - 1^2 = 3$. To indicate this graphically, we use an open circle at the point $(1, 3)$. Putting all of this information together and plotting additional points, we get

x	$f(x)$	$(x, f(x))$
0.9	3.19	$(0.9, 3.19)$
0.99	≈ 3.02	$(0.99, 3.02)$
0.999	≈ 3.002	$(0.999, 3.002)$

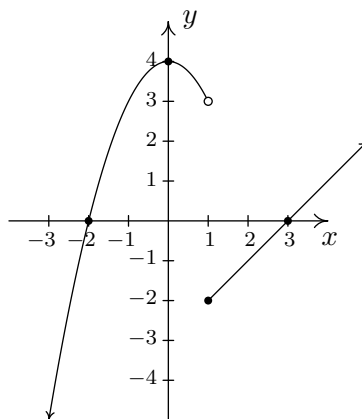

□

¹We've just stepped into Calculus here!

In the previous two examples, the x -coordinates of the x -intercepts of the graph of $y = f(x)$ were found by solving $f(x) = 0$. For this reason, they are called the **zeros** of f .

Definition 1.9. The **zeros** of a function f are the solutions to the equation $f(x) = 0$. In other words, x is a zero of f if and only if $(x, 0)$ is an x -intercept of the graph of $y = f(x)$.

Of the three symmetries discussed in Section 1.2.1, only two are of significance to functions: symmetry about the y -axis and symmetry about the origin.² Recall that we can test whether the graph of an equation is symmetric about the y -axis by replacing x with $-x$ and checking to see if an equivalent equation results. If we are graphing the equation $y = f(x)$, substituting $-x$ for x results in the equation $y = f(-x)$. In order for this equation to be equivalent to the original equation $y = f(x)$ we need $f(-x) = f(x)$. In a similar fashion, we recall that to test an equation's graph for symmetry about the origin, we replace x and y with $-x$ and $-y$, respectively. Doing this substitution in the equation $y = f(x)$ results in $-y = f(-x)$. Solving the latter equation for y gives $y = -f(-x)$. In order for this equation to be equivalent to the original equation $y = f(x)$ we need $-f(-x) = f(x)$, or, equivalently, $f(-x) = -f(x)$. These results are summarized below.

Testing the Graph of a Function for Symmetry

The graph of a function f is symmetric

- about the y -axis if and only if $f(-x) = f(x)$ for all x in the domain of f .
- about the origin if and only if $f(-x) = -f(x)$ for all x in the domain of f .

For reasons which won't become clear until we study polynomials, we call a function **even** if its graph is symmetric about the y -axis or **odd** if its graph is symmetric about the origin. Apart from a very specialized family of functions which are both even and odd,³ functions fall into one of three distinct categories: even, odd, or neither even nor odd.

Example 1.6.3. Determine analytically if the following functions are even, odd, or neither even nor odd. Verify your result with a graphing calculator.

1. $f(x) = \frac{5}{2 - x^2}$

2. $g(x) = \frac{5x}{2 - x^2}$

3. $h(x) = \frac{5x}{2 - x^3}$

4. $i(x) = \frac{5x}{2x - x^3}$

5. $j(x) = x^2 - \frac{x}{100} - 1$

6. $p(x) = \begin{cases} x + 3 & \text{if } x < 0 \\ -x + 3, & \text{if } x \geq 0 \end{cases}$

Solution. The first step in all of these problems is to replace x with $-x$ and simplify.

²Why are we so dismissive about symmetry about the x -axis for graphs of functions?

³Any ideas?

1.

$$f(x) = \frac{5}{2-x^2}$$

$$f(-x) = \frac{5}{2-(-x)^2}$$

$$f(-x) = \frac{5}{2-x^2}$$

$$f(-x) = f(x)$$

Hence, f is **even**. The graphing calculator furnishes the following.

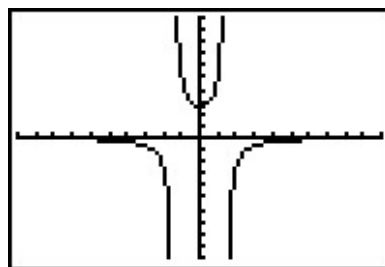
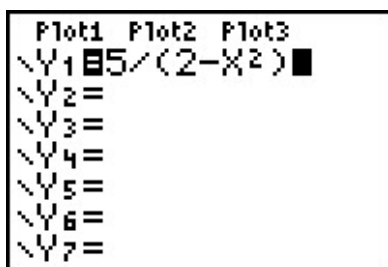

This suggests⁴ that the graph of f is symmetric about the y -axis, as expected.

2.

$$g(x) = \frac{5x}{2-x^2}$$

$$g(-x) = \frac{5(-x)}{2-(-x)^2}$$

$$g(-x) = \frac{-5x}{2-x^2}$$

It doesn't appear that $g(-x)$ is equivalent to $g(x)$. To prove this, we check with an x value. After some trial and error, we see that $g(1) = 5$ whereas $g(-1) = -5$. This proves that g is not even, but it doesn't rule out the possibility that g is odd. (Why not?) To check if g is odd, we compare $g(-x)$ with $-g(x)$

$$-g(x) = -\frac{5x}{2-x^2}$$

$$= \frac{-5x}{2-x^2}$$

$$-g(x) = g(-x)$$

Hence, g is odd. Graphically,

⁴'Suggests' is about the extent of what it can do.

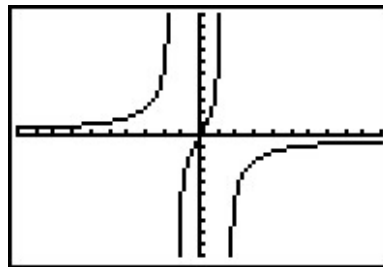
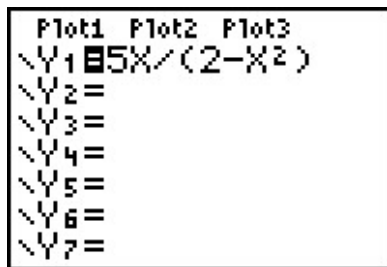

The calculator indicates the graph of g is symmetric about the origin, as expected.

3.

$$h(x) = \frac{5x}{2 - x^3}$$

$$h(-x) = \frac{5(-x)}{2 - (-x)^3}$$

$$h(-x) = \frac{-5x}{2 + x^3}$$

Once again, $h(-x)$ doesn't appear to be equivalent to $h(x)$. We check with an x value, for example, $h(1) = 5$ but $h(-1) = -\frac{5}{3}$. This proves that h is not even and it also shows h is not odd. (Why?) Graphically,

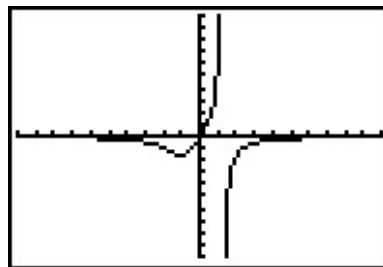
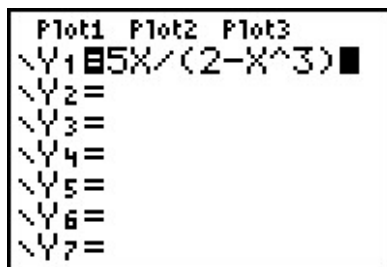

The graph of h appears to be neither symmetric about the y -axis nor the origin.

4.

$$i(x) = \frac{5x}{2x - x^3}$$

$$i(-x) = \frac{5(-x)}{2(-x) - (-x)^3}$$

$$i(-x) = \frac{-5x}{-2x + x^3}$$

The expression $i(-x)$ doesn't appear to be equivalent to $i(x)$. However, after checking some x values, for example $x = 1$ yields $i(1) = 5$ and $i(-1) = 5$, it appears that $i(-x)$ does, in fact, equal $i(x)$. However, while this suggests i is even, it doesn't prove it. (It does, however, prove

i is not odd.) To prove $i(-x) = i(x)$, we need to manipulate our expressions for $i(x)$ and $i(-x)$ and show that they are equivalent. A clue as to how to proceed is in the numerators: in the formula for $i(x)$, the numerator is $5x$ and in $i(-x)$ the numerator is $-5x$. To re-write $i(x)$ with a numerator of $-5x$, we need to multiply its numerator by -1 . To keep the value of the fraction the same, we need to multiply the denominator by -1 as well. Thus

$$\begin{aligned} i(x) &= \frac{5x}{2x - x^3} \\ &= \frac{(-1)5x}{(-1)(2x - x^3)} \\ &= \frac{-5x}{-2x + x^3} \end{aligned}$$

Hence, $i(x) = i(-x)$, so i is even. The calculator supports our conclusion.

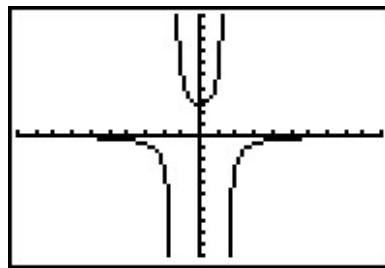
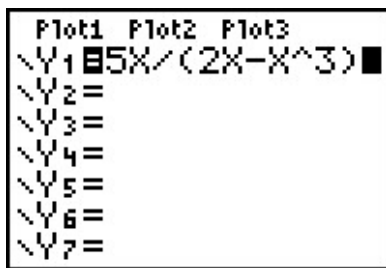

5.

$$\begin{aligned} j(x) &= x^2 - \frac{x}{100} - 1 \\ j(-x) &= (-x)^2 - \frac{-x}{100} - 1 \\ j(-x) &= x^2 + \frac{x}{100} - 1 \end{aligned}$$

The expression for $j(-x)$ doesn't seem to be equivalent to $j(x)$, so we check using $x = 1$ to get $j(1) = -\frac{1}{100}$ and $j(-1) = \frac{1}{100}$. This rules out j being even. However, it doesn't rule out j being odd. Examining $-j(x)$ gives

$$\begin{aligned} j(x) &= x^2 - \frac{x}{100} - 1 \\ -j(x) &= -\left(x^2 - \frac{x}{100} - 1\right) \\ -j(x) &= -x^2 + \frac{x}{100} + 1 \end{aligned}$$

The expression $-j(x)$ doesn't seem to match $j(-x)$ either. Testing $x = 2$ gives $j(2) = \frac{149}{50}$ and $j(-2) = \frac{151}{50}$, so j is not odd, either. The calculator gives:

```

Plot1 Plot2 Plot3
\Y1  $X^2 - X/100 - 1$ 
\Y2 =
\Y3 =
\Y4 =
\Y5 =
\Y6 =
\Y7 =

```

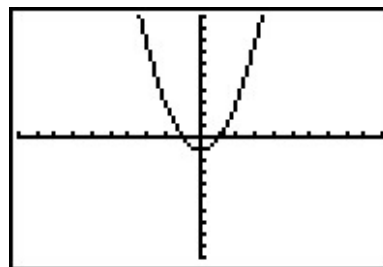

The calculator suggests that the graph of j is symmetric about the y -axis which would imply that j is even. However, we have proven that is not the case. \square

6. Testing the graph of $y = p(x)$ for symmetry is complicated by the fact $p(x)$ is a piecewise-defined function. As always, we handle this by checking the condition for symmetry by checking it on each piece of the domain. We first consider the case when $x < 0$ and set about finding the correct expression for $p(-x)$. Even though $p(x) = x + 3$ for $x < 0$, $p(-x) \neq -x + 3$ here. The reason for this is that since $x < 0$, $-x > 0$ which means to find $p(-x)$, we need to use the *other* formula for $p(x)$, namely $p(x) = -x + 3$. Hence, for $x < 0$, $p(-x) = -(-x) + 3 = x + 3 = p(x)$. For $x \geq 0$, $p(x) = -x + 3$ and we have two cases. If $x > 0$, then $-x < 0$ so $p(-x) = (-x) + 3 = -x + 3 = p(x)$. If $x = 0$, then $p(0) = 3 = p(-0)$. Hence, in all cases, $p(-x) = p(x)$, so p is even. Since $p(0) = 3$ but $p(-0) = p(0) = 3 \neq -3$, we also have p is not odd. While graphing $y = p(x)$ is not onerous to do by hand, it is instructive to see how to enter this into our calculator. By using some of the logical commands,⁵ we have:

```

Plot1 Plot2 Plot3
\Y1  $(X+3)(X<0)$ 
\Y2  $(-X+3)(X\geq 0)$ 
\Y3 =
\Y4 =
\Y5 =
\Y6 =
\Y7 =

```

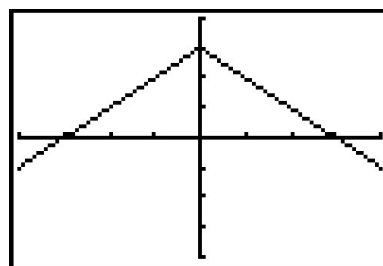

The calculator bears shows that the graph appears to be symmetric about the y -axis. \square

There are two lessons to be learned from the last example. The first is that sampling function values at particular x values is not enough to prove that a function is even or odd – despite the fact that $j(-1) = -j(1)$, j turned out not to be odd. Secondly, while the calculator may *suggest* mathematical truths, it is the Algebra which *proves* mathematical truths.⁶

⁵Consult your owner's manual, instructor, or favorite video site!

⁶Or, in other words, don't rely too heavily on the machine!

1.6.1 GENERAL FUNCTION BEHAVIOR

The last topic we wish to address in this section is general function behavior. As you shall see in the next several chapters, each family of functions has its own unique attributes and we will study them all in great detail. The purpose of this section's discussion, then, is to lay the foundation for that further study by investigating aspects of function behavior which apply to all functions. To start, we will examine the concepts of **increasing**, **decreasing** and **constant**. Before defining the concepts algebraically, it is instructive to first look at them graphically. Consider the graph of the function f below.

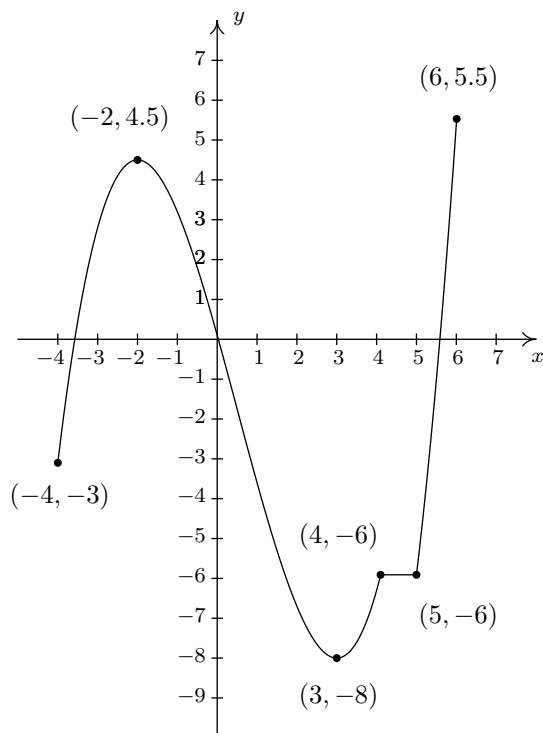
The graph of $y = f(x)$

Reading from left to right, the graph ‘starts’ at the point $(-4, -3)$ and ‘ends’ at the point $(6, 5.5)$. If we imagine walking from left to right on the graph, between $(-4, -3)$ and $(-2, 4.5)$, we are walking ‘uphill’; then between $(-2, 4.5)$ and $(3, -8)$, we are walking ‘downhill’; and between $(3, -8)$ and $(4, -6)$, we are walking ‘uphill’ once more. From $(4, -6)$ to $(5, -6)$, we ‘level off’, and then resume walking ‘uphill’ from $(5, -6)$ to $(6, 5.5)$. In other words, for the x values between -4 and -2 (inclusive), the y -coordinates on the graph are getting larger, or **increasing**, as we move from left to right. Since $y = f(x)$, the y values on the graph are the function values, and we say that the function f is **increasing** on the interval $[-4, -2]$. Analogously, we say that f is **decreasing** on the interval $[-2, 3]$ increasing once more on the interval $[3, 4]$, **constant** on $[4, 5]$, and finally increasing once again on $[5, 6]$. It is extremely important to notice that the behavior (increasing, decreasing or constant) occurs on an interval on the x -axis. When we say that the function f is increasing

on $[-4, -2]$ we do not mention the actual y values that f attains along the way. Thus, we report *where* the behavior occurs, not to what extent the behavior occurs.⁷ Also notice that we do not say that a function is increasing, decreasing or constant at a single x value. In fact, we would run into serious trouble in our previous example if we tried to do so because $x = -2$ is contained in an interval on which f was increasing and one on which it is decreasing. (There's more on this issue – and many others – in the Exercises.)

We're now ready for the more formal algebraic definitions of what it means for a function to be increasing, decreasing or constant.

Definition 1.10. Suppose f is a function defined on an interval I . We say f is:

- **increasing** on I if and only if $f(a) < f(b)$ for all real numbers a, b in I with $a < b$.
- **decreasing** on I if and only if $f(a) > f(b)$ for all real numbers a, b in I with $a < b$.
- **constant** on I if and only if $f(a) = f(b)$ for all real numbers a, b in I .

It is worth taking some time to see that the algebraic descriptions of increasing, decreasing and constant as stated in Definition 1.10 agree with our graphical descriptions given earlier. You should look back through the examples and exercise sets in previous sections where graphs were given to see if you can determine the intervals on which the functions are increasing, decreasing or constant. Can you find an example of a function for which none of the concepts in Definition 1.10 apply?

Now let's turn our attention to a few of the points on the graph. Clearly the point $(-2, 4.5)$ does not have the largest y value of all of the points on the graph of f – indeed that honor goes to $(6, 5.5)$ – but $(-2, 4.5)$ should get some sort of consolation prize for being 'the top of the hill' between $x = -4$ and $x = 3$. We say that the function f has a **local maximum**⁸ at the point $(-2, 4.5)$, because the y -coordinate 4.5 is the largest y -value (hence, function value) on the curve 'near'⁹ $x = -2$. Similarly, we say that the function f has a **local minimum**¹⁰ at the point $(3, -8)$, since the y -coordinate -8 is the smallest function value near $x = 3$. Although it is tempting to say that local extrema¹¹ occur when the function changes from increasing to decreasing or vice versa, it is not a precise enough way to define the concepts for the needs of Calculus. At the risk of being pedantic, we will present the traditional definitions and thoroughly vet the pathologies they induce in the Exercises. We have one last observation to make before we proceed to the algebraic definitions and look at a fairly tame, yet helpful, example.

If we look at the entire graph, we see that the largest y value (the largest function value) is 5.5 at $x = 6$. In this case, we say the **maximum**¹² of f is 5.5; similarly, the **minimum**¹³ of f is -8 .

⁷The notions of how quickly or how slowly a function increases or decreases are explored in Calculus.

⁸Also called 'relative maximum'.

⁹We will make this more precise in a moment.

¹⁰Also called a 'relative minimum'.

¹¹'Maxima' is the plural of 'maximum' and 'minima' is the plural of 'minimum'. 'Extrema' is the plural of 'extremum' which combines maximum and minimum.

¹²Sometimes called the 'absolute' or 'global' maximum.

¹³Again, 'absolute' or 'global' minimum can be used.

We formalize these concepts in the following definitions.

Definition 1.11. Suppose f is a function with $f(a) = b$.

- We say f has a **local maximum** at the point (a, b) if and only if there is an open interval I containing a for which $f(a) \geq f(x)$ for all x in I . The value $f(a) = b$ is called ‘a local maximum value of f ’ in this case.
- We say f has a **local minimum** at the point (a, b) if and only if there is an open interval I containing a for which $f(a) \leq f(x)$ for all x in I . The value $f(a) = b$ is called ‘a local minimum value of f ’ in this case.
- The value b is called the **maximum** of f if $b \geq f(x)$ for all x in the domain of f .
- The value b is called the **minimum** of f if $b \leq f(x)$ for all x in the domain of f .

It’s important to note that not every function will have all of these features. Indeed, it is possible to have a function with no local or absolute extrema at all! (Any ideas of what such a function’s graph would have to look like?) We shall see examples of functions in the Exercises which have one or two, but not all, of these features, some that have instances of each type of extremum and some functions that seem to defy common sense. In all cases, though, we shall adhere to the algebraic definitions above as we explore the wonderful diversity of graphs that functions provide us.

Here is the ‘tame’ example which was promised earlier. It summarizes all of the concepts presented in this section as well as some from previous sections so you should spend some time thinking deeply about it before proceeding to the Exercises.

Example 1.6.4. Given the graph of $y = f(x)$ below, answer all of the following questions.

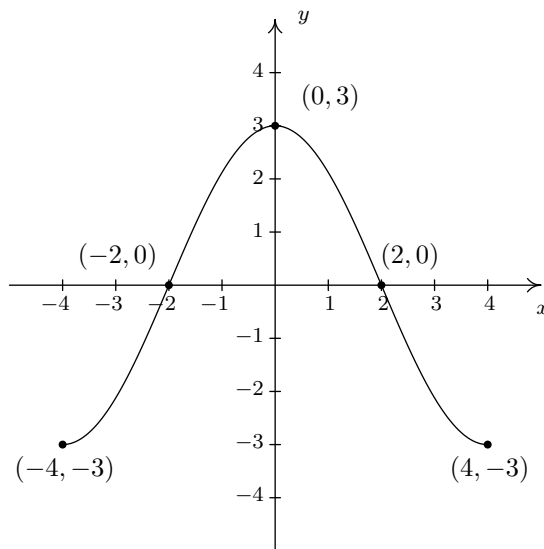

1. Find the domain of f .
2. Find the range of f .
3. List the x -intercepts, if any exist.
4. List the y -intercepts, if any exist.
5. Find the zeros of f .
6. Solve $f(x) < 0$.
7. Determine $f(2)$.
8. Solve $f(x) = -3$.
9. Find the number of solutions to $f(x) = 1$.
10. Does f appear to be even, odd, or neither?
11. List the intervals on which f is increasing.
12. List the intervals on which f is decreasing.
13. List the local maximums, if any exist.
14. List the local minimums, if any exist.
15. Find the maximum, if it exists.
16. Find the minimum, if it exists.

Solution.

1. To find the domain of f , we proceed as in Section 1.3. By projecting the graph to the x -axis, we see that the portion of the x -axis which corresponds to a point on the graph is everything from -4 to 4 , inclusive. Hence, the domain is $[-4, 4]$.
2. To find the range, we project the graph to the y -axis. We see that the y values from -3 to 3 , inclusive, constitute the range of f . Hence, our answer is $[-3, 3]$.
3. The x -intercepts are the points on the graph with y -coordinate 0 , namely $(-2, 0)$ and $(2, 0)$.
4. The y -intercept is the point on the graph with x -coordinate 0 , namely $(0, 3)$.
5. The zeros of f are the x -coordinates of the x -intercepts of the graph of $y = f(x)$ which are $x = -2, 2$.
6. To solve $f(x) < 0$, we look for the x values of the points on the graph where the y -coordinate is less than 0 . Graphically, we are looking for where the graph is below the x -axis. This happens for the x values from -4 to -2 and again from 2 to 4 . So our answer is $[-4, -2) \cup (2, 4]$.
7. Since the graph of f is the graph of the equation $y = f(x)$, $f(2)$ is the y -coordinate of the point which corresponds to $x = 2$. Since the point $(2, 0)$ is on the graph, we have $f(2) = 0$.
8. To solve $f(x) = -3$, we look where $y = f(x) = -3$. We find two points with a y -coordinate of -3 , namely $(-4, -3)$ and $(4, -3)$. Hence, the solutions to $f(x) = -3$ are $x = \pm 4$.
9. As in the previous problem, to solve $f(x) = 1$, we look for points on the graph where the y -coordinate is 1 . Even though these points aren't specified, we see that the curve has two points with a y value of 1 , as seen in the graph below. That means there are two solutions to $f(x) = 1$.

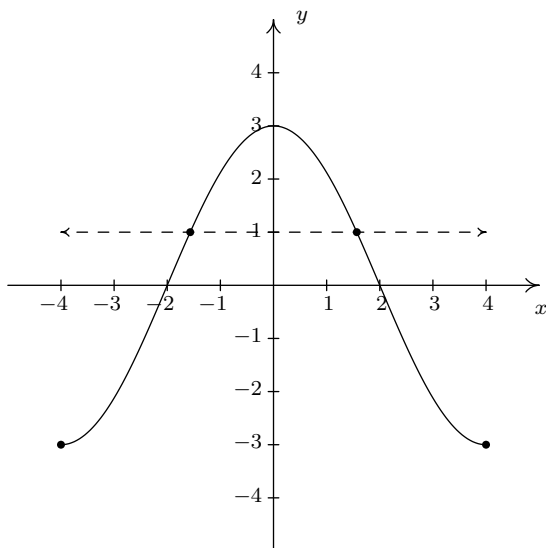

10. The graph appears to be symmetric about the y -axis. This suggests¹⁴ that f is even.
11. As we move from left to right, the graph rises from $(-4, -3)$ to $(0, 3)$. This means f is increasing on the interval $[-4, 0]$. (Remember, the answer here is an interval on the x -axis.)
12. As we move from left to right, the graph falls from $(0, 3)$ to $(4, -3)$. This means f is decreasing on the interval $[0, 4]$. (Remember, the answer here is an interval on the x -axis.)
13. The function has its only local maximum at $(0, 3)$ so $f(0) = 3$ is the local minimum value.
14. There are no local minimums. Why don't $(-4, -3)$ and $(4, -3)$ count? Let's consider the point $(-4, -3)$ for a moment. Recall that, in the definition of local minimum, there needs to be an open interval I which contains $x = -4$ such that $f(-4) < f(x)$ for all x in I different from -4 . But if we put an open interval around $x = -4$ a portion of that interval will lie outside of the domain of f . Because we are unable to fulfill the requirements of the definition for a local minimum, we cannot claim that f has one at $(-4, -3)$. The point $(4, -3)$ fails for the same reason – no open interval around $x = 4$ stays within the domain of f .
15. The maximum value of f is the largest y -coordinate which is 3.
16. The minimum value of f is the smallest y -coordinate which is -3 . □

With few exceptions, we will not develop techniques in College Algebra which allow us to determine the intervals on which a function is increasing, decreasing or constant or to find the local maximums and local minimums analytically; this is the business of Calculus.¹⁵ When we have need to find such beasts, we will resort to the calculator. Most graphing calculators have 'Minimum' and 'Maximum' features which can be used to approximate these values, as we now demonstrate.

¹⁴but does not prove

¹⁵Although, truth be told, there is only one step of Calculus involved, followed by several pages of algebra.

Example 1.6.5. Let $f(x) = \frac{15x}{x^2 + 3}$. Use a graphing calculator to approximate the intervals on which f is increasing and those on which it is decreasing. Approximate all extrema.

Solution. Entering this function into the calculator gives

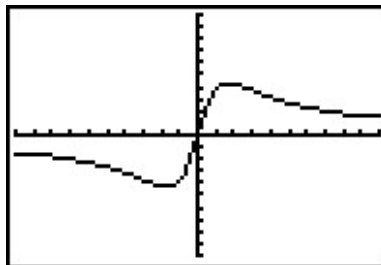
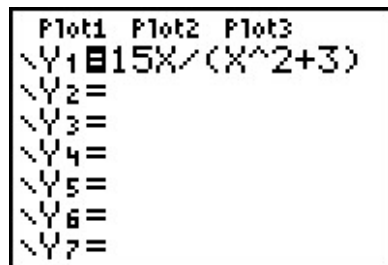

Using the Minimum and Maximum features, we get

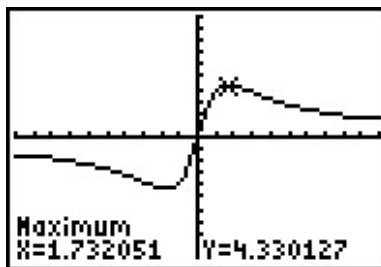
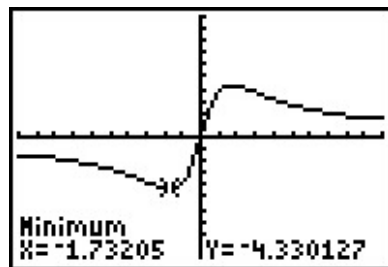

To two decimal places, f appears to have its only local minimum at $(-1.73, -4.33)$ and its only local maximum at $(1.73, 4.33)$. Given the symmetry about the origin suggested by the graph, the relation between these points shouldn't be too surprising. The function appears to be increasing on $[-1.73, 1.73]$ and decreasing on $(-\infty, -1.73] \cup [1.73, \infty)$. This makes -4.33 the (absolute) minimum and 4.33 the (absolute) maximum. \square

Example 1.6.6. Find the points on the graph of $y = (x - 3)^2$ which are closest to the origin. Round your answers to two decimal places.

Solution. Suppose a point (x, y) is on the graph of $y = (x - 3)^2$. Its distance to the origin $(0, 0)$ is given by

$$\begin{aligned} d &= \sqrt{(x-0)^2 + (y-0)^2} \\ &= \sqrt{x^2 + y^2} \\ &= \sqrt{x^2 + [(x-3)^2]^2} \quad \text{Since } y = (x-3)^2 \\ &= \sqrt{x^2 + (x-3)^4} \end{aligned}$$

Given a value for x , the formula $d = \sqrt{x^2 + (x-3)^4}$ is the distance from $(0, 0)$ to the point (x, y) on the curve $y = (x-3)^2$. What we have defined, then, is a function $d(x)$ which we wish to

minimize over all values of x . To accomplish this task analytically would require Calculus so as we've mentioned before, we can use a graphing calculator to find an approximate solution. Using the calculator, we enter the function $d(x)$ as shown below and graph.

Plot1 Plot2 Plot3
 Y1 = $\sqrt{(X^2 + (X-3)^2)}$
 Y2 =
 Y3 =
 Y4 =
 Y5 =
 Y6 =

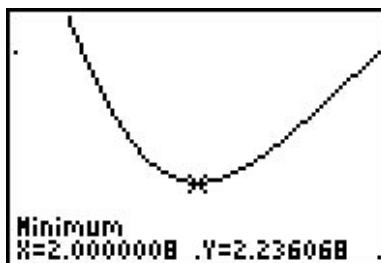

Using the Minimum feature, we see above on the right that the (absolute) minimum occurs near $x = 2$. Rounding to two decimal places, we get that the minimum distance occurs when $x = 2.00$. To find the y value on the parabola associated with $x = 2.00$, we substitute 2.00 into the equation to get $y = (x - 3)^2 = (2.00 - 3)^2 = 1.00$. So, our final answer is $(2.00, 1.00)$.¹⁶ (What does the y value listed on the calculator screen mean in this problem?) \square

¹⁶It seems silly to list a final answer as $(2.00, 1.00)$. Indeed, Calculus confirms that the *exact* answer to this problem is, in fact, $(2, 1)$. As you are well aware by now, the authors are overly pedantic, and as such, use the decimal places to remind the reader that *any* result garnered from a calculator in this fashion is an approximation, and should be treated as such.

1.6.2 EXERCISES

In Exercises 1 - 12, sketch the graph of the given function. State the domain of the function, identify any intercepts and test for symmetry.

1. $f(x) = 2 - x$

2. $f(x) = \frac{x-2}{3}$

3. $f(x) = x^2 + 1$

4. $f(x) = 4 - x^2$

5. $f(x) = 2$

6. $f(x) = x^3$

7. $f(x) = x(x-1)(x+2)$

8. $f(x) = \sqrt{x-2}$

9. $f(x) = \sqrt{5-x}$

10. $f(x) = 3 - 2\sqrt{x+2}$

11. $f(x) = \sqrt[3]{x}$

12. $f(x) = \frac{1}{x^2+1}$

In Exercises 13 - 20, sketch the graph of the given piecewise-defined function.

13. $f(x) = \begin{cases} 4-x & \text{if } x \leq 3 \\ 2 & \text{if } x > 3 \end{cases}$

14. $f(x) = \begin{cases} x^2 & \text{if } x \leq 0 \\ 2x & \text{if } x > 0 \end{cases}$

15. $f(x) = \begin{cases} -3 & \text{if } x < 0 \\ 2x-3 & \text{if } 0 \leq x \leq 3 \\ 3 & \text{if } x > 3 \end{cases}$

16. $f(x) = \begin{cases} x^2-4 & \text{if } x \leq -2 \\ 4-x^2 & \text{if } -2 < x < 2 \\ x^2-4 & \text{if } x \geq 2 \end{cases}$

17. $f(x) = \begin{cases} -2x-4 & \text{if } x < 0 \\ 3x & \text{if } x \geq 0 \end{cases}$

18. $f(x) = \begin{cases} \sqrt{x+4} & \text{if } -4 \leq x < 5 \\ \sqrt{x-1} & \text{if } x \geq 5 \end{cases}$

19. $f(x) = \begin{cases} x^2 & \text{if } x \leq -2 \\ 3-x & \text{if } -2 < x < 2 \\ 4 & \text{if } x \geq 2 \end{cases}$

20. $f(x) = \begin{cases} \frac{1}{x} & \text{if } -6 < x < -1 \\ x & \text{if } -1 < x < 1 \\ \sqrt{x} & \text{if } 1 < x < 9 \end{cases}$

In Exercises 21 - 41, determine analytically if the following functions are even, odd or neither.

21. $f(x) = 7x$

22. $f(x) = 7x + 2$

23. $f(x) = 7$

24. $f(x) = 3x^2 - 4$

25. $f(x) = 4 - x^2$

26. $f(x) = x^2 - x - 6$

27. $f(x) = 2x^3 - x$

28. $f(x) = -x^5 + 2x^3 - x$

29. $f(x) = x^6 - x^4 + x^2 + 9$

30. $f(x) = x^3 + x^2 + x + 1$

31. $f(x) = \sqrt{1-x}$

32. $f(x) = \sqrt{1-x^2}$

33. $f(x) = 0$

34. $f(x) = \sqrt[3]{x}$

35. $f(x) = \sqrt[3]{x^2}$

36. $f(x) = \frac{3}{x^2}$

37. $f(x) = \frac{2x-1}{x+1}$

38. $f(x) = \frac{3x}{x^2+1}$

39. $f(x) = \frac{x^2-3}{x-4x^3}$

40. $f(x) = \frac{9}{\sqrt{4-x^2}}$

41. $f(x) = \frac{\sqrt[3]{x^3+x}}{5x}$

In Exercises 42 - 57, use the graph of $y = f(x)$ given below to answer the question.

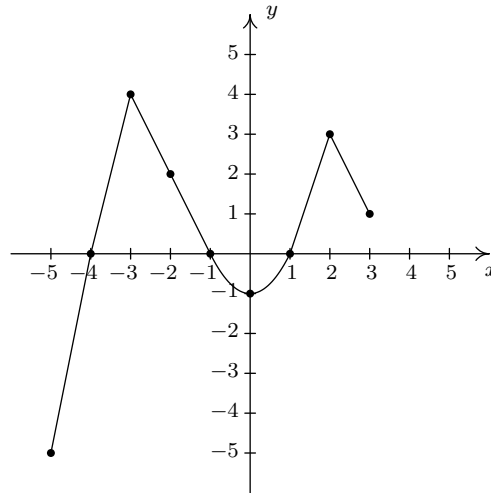
42. Find the domain of f .43. Find the range of f .44. Determine $f(-2)$.45. Solve $f(x) = 4$.46. List the x -intercepts, if any exist.47. List the y -intercepts, if any exist.48. Find the zeros of f .49. Solve $f(x) \geq 0$.50. Find the number of solutions to $f(x) = 1$.51. Does f appear to be even, odd, or neither?52. List the intervals where f is increasing.53. List the intervals where f is decreasing.

54. List the local maximums, if any exist.

55. List the local minimums, if any exist.

56. Find the maximum, if it exists.

57. Find the minimum, if it exists.

In Exercises 58 - 73, use the graph of $y = f(x)$ given below to answer the question.

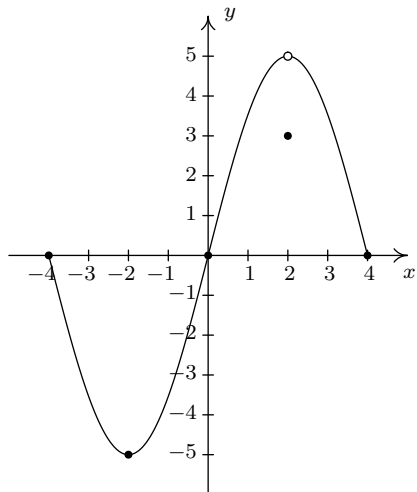

- | | |
|--|--|
| 58. Find the domain of f . | 59. Find the range of f . |
| 60. Determine $f(2)$. | 61. Solve $f(x) = -5$. |
| 62. List the x -intercepts, if any exist. | 63. List the y -intercepts, if any exist. |
| 64. Find the zeros of f . | 65. Solve $f(x) \leq 0$. |
| 66. Find the number of solutions to $f(x) = 3$. | 67. Does f appear to be even, odd, or neither? |
| 68. List the intervals where f is increasing. | 69. List the intervals where f is decreasing. |
| 70. List the local maximums, if any exist. | 71. List the local minimums, if any exist. |
| 72. Find the maximum, if it exists. | 73. Find the minimum, if it exists. |

In Exercises 74 - 77, use your graphing calculator to approximate the local and absolute extrema of the given function. Approximate the intervals on which the function is increasing and those on which it is decreasing. Round your answers to two decimal places.

- | | |
|--|------------------------------|
| 74. $f(x) = x^4 - 3x^3 - 24x^2 + 28x + 48$ | 75. $f(x) = x^{2/3}(x - 4)$ |
| 76. $f(x) = \sqrt{9 - x^2}$ | 77. $f(x) = x\sqrt{9 - x^2}$ |

In Exercises 78 - 85, use the graphs of $y = f(x)$ and $y = g(x)$ below to find the function value.

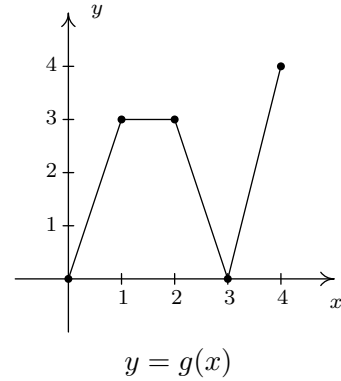
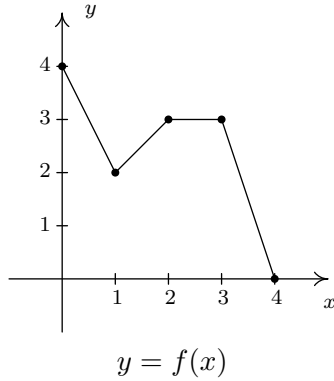

78. $(f + g)(0)$ 79. $(f + g)(1)$ 80. $(f - g)(1)$ 81. $(g - f)(2)$
 82. $(fg)(2)$ 83. $(fg)(1)$ 84. $\left(\frac{f}{g}\right)(4)$ 85. $\left(\frac{g}{f}\right)(2)$

The graph below represents the height h of a Sasquatch (in feet) as a function of its age N in years. Use it to answer the questions in Exercises 86 - 90.

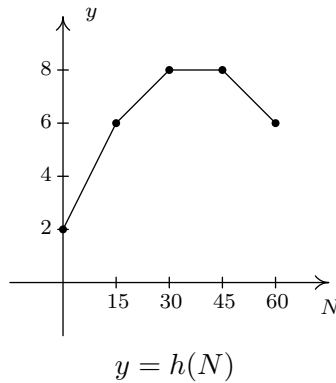

86. Find and interpret $h(0)$.
 87. How tall is the Sasquatch when she is 15 years old?
 88. Solve $h(N) = 6$ and interpret.
 89. List the interval over which h is constant and interpret your answer.
 90. List the interval over which h is decreasing and interpret your answer.

For Exercises 91 - 93, let $f(x) = \lfloor x \rfloor$ be the greatest integer function as defined in Exercise 75 in Section 1.4.

91. Graph $y = f(x)$. Be careful to correctly describe the behavior of the graph near the integers.
92. Is f even, odd, or neither? Explain.
93. Discuss with your classmates which points on the graph are local minimums, local maximums or both. Is f ever increasing? Decreasing? Constant?

In Exercises 94 - 95, use your graphing calculator to show that the given function does not have any extrema, neither local nor absolute.

94. $f(x) = x^3 + x - 12$

95. $f(x) = -5x + 2$

96. In Exercise 71 in Section 1.4, we saw that the population of Sasquatch in Portage County could be modeled by the function $P(t) = \frac{150t}{t + 15}$, where $t = 0$ represents the year 1803. Use your graphing calculator to analyze the general function behavior of P . Will there ever be a time when 200 Sasquatch roam Portage County?
97. Suppose f and g are both even functions. What can be said about the functions $f + g$, $f - g$, fg and $\frac{f}{g}$? What if f and g are both odd? What if f is even but g is odd?
98. One of the most important aspects of the Cartesian Coordinate Plane is its ability to put Algebra into geometric terms and Geometry into algebraic terms. We've spent most of this chapter looking at this very phenomenon and now you should spend some time with your classmates reviewing what we've done. What major results do we have that tie Algebra and Geometry together? What concepts from Geometry have we not yet described algebraically? What topics from Intermediate Algebra have we not yet discussed geometrically?

It's now time to "thoroughly vet the pathologies induced" by the precise definitions of local maximum and local minimum. We'll do this by providing you and your classmates a series of Exercises to discuss. You will need to refer back to Definition 1.10 (Increasing, Decreasing and Constant) and Definition 1.11 (Maximum and Minimum) during the discussion.

99. Consider the graph of the function f given below.

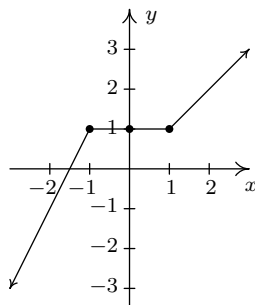

- (a) Show that f has a local maximum but not a local minimum at the point $(-1, 1)$.
- (b) Show that f has a local minimum but not a local maximum at the point $(1, 1)$.
- (c) Show that f has a local maximum AND a local minimum at the point $(0, 1)$.
- (d) Show that f is constant on the interval $[-1, 1]$ and thus has both a local maximum AND a local minimum at every point $(x, f(x))$ where $-1 < x < 1$.
100. Using Example 1.6.4 as a guide, show that the function g whose graph is given below does not have a local maximum at $(-3, 5)$ nor does it have a local minimum at $(3, -3)$. Find its extrema, both local and absolute. What's unique about the point $(0, -4)$ on this graph? Also find the intervals on which g is increasing and those on which g is decreasing.

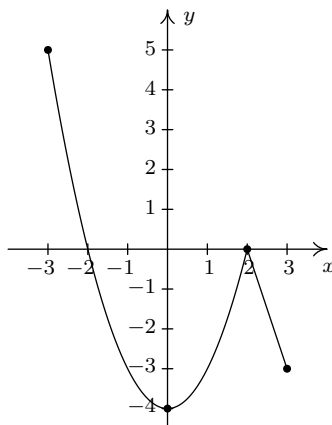

101. We said earlier in the section that it is not good enough to say local extrema exist where a function changes from increasing to decreasing or vice versa. As a previous exercise showed, we could have local extrema when a function is constant so now we need to examine some functions whose graphs do indeed change direction. Consider the functions graphed below. Notice that all four of them change direction at an open circle on the graph. Examine each for local extrema. What is the effect of placing the “dot” on the y -axis above or below the open circle? What could you say if no function value were assigned to $x = 0$?

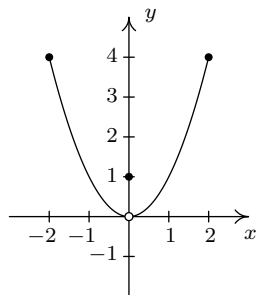

(a) Function I

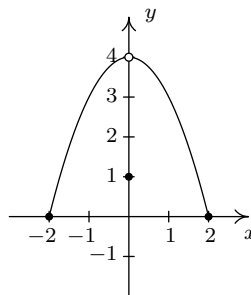

(b) Function II

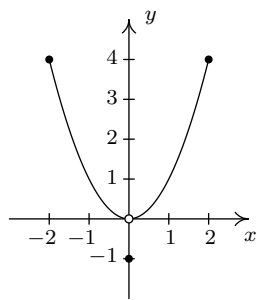

(c) Function III

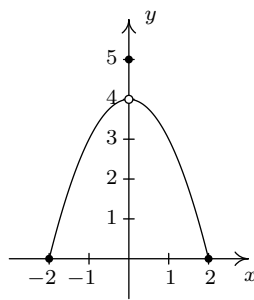

(d) Function IV

1.6.3 ANSWERS

1. $f(x) = 2 - x$

Domain: $(-\infty, \infty)$ x -intercept: $(2, 0)$ y -intercept: $(0, 2)$

No symmetry

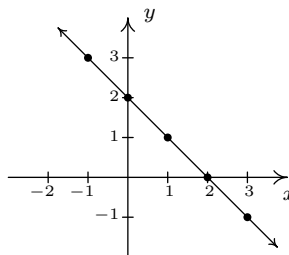

2. $f(x) = \frac{x - 2}{3}$

Domain: $(-\infty, \infty)$ x -intercept: $(2, 0)$ y -intercept: $(0, -\frac{2}{3})$

No symmetry

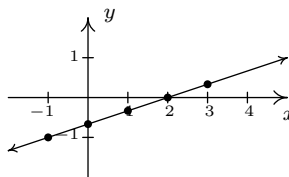

3. $f(x) = x^2 + 1$

Domain: $(-\infty, \infty)$ x -intercept: None y -intercept: $(0, 1)$

Even

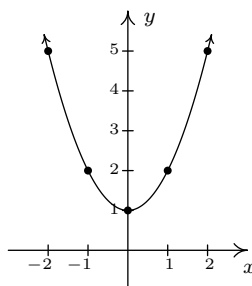

4. $f(x) = 4 - x^2$

Domain: $(-\infty, \infty)$ x -intercepts: $(-2, 0), (2, 0)$ y -intercept: $(0, 4)$

Even

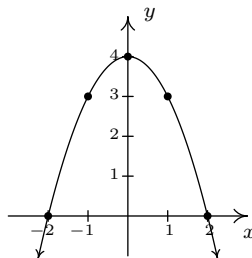

5. $f(x) = 2$

Domain: $(-\infty, \infty)$ x -intercept: None y -intercept: $(0, 2)$

Even

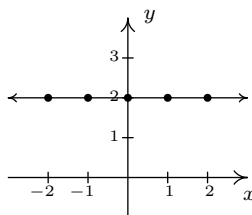

6. $f(x) = x^3$

Domain: $(-\infty, \infty)$ x -intercept: $(0, 0)$ y -intercept: $(0, 0)$

Odd

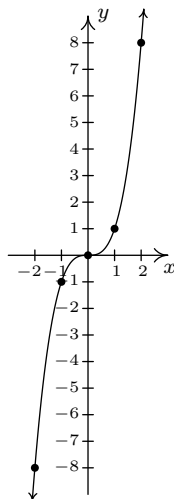

7. $f(x) = x(x-1)(x+2)$

Domain: $(-\infty, \infty)$ x -intercepts: $(-2, 0)$, $(0, 0)$, $(1, 0)$ y -intercept: $(0, 0)$

No symmetry

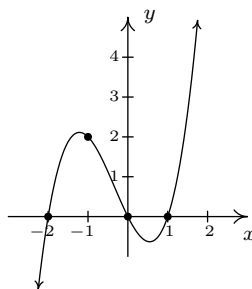

8. $f(x) = \sqrt{x-2}$

Domain: $[2, \infty)$ x -intercept: $(2, 0)$ y -intercept: None

No symmetry

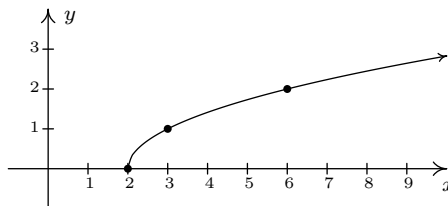

9. $f(x) = \sqrt{5-x}$

Domain: $(-\infty, 5]$ x -intercept: $(5, 0)$ y -intercept: $(0, \sqrt{5})$

No symmetry

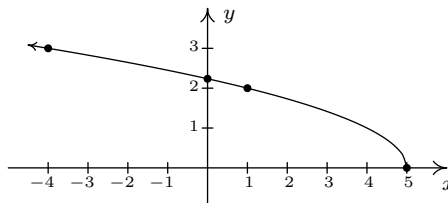

10. $f(x) = 3 - 2\sqrt{x+2}$

Domain: $[-2, \infty)$ x -intercept: $(\frac{1}{4}, 0)$ y -intercept: $(0, 3 - 2\sqrt{2})$

No symmetry

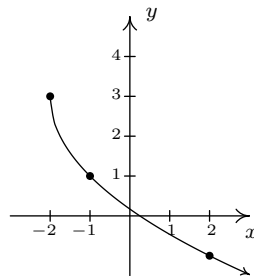

11. $f(x) = \sqrt[3]{x}$

Domain: $(-\infty, \infty)$ x -intercept: $(0, 0)$ y -intercept: $(0, 0)$

Odd

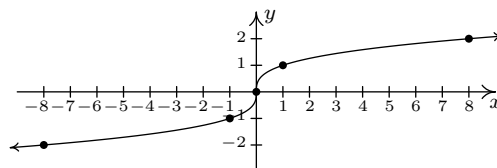

12. $f(x) = \frac{1}{x^2 + 1}$

Domain: $(-\infty, \infty)$ x -intercept: None y -intercept: $(0, 1)$

Even

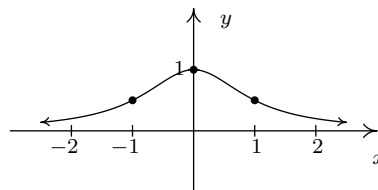

13.

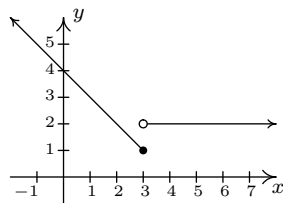

14.

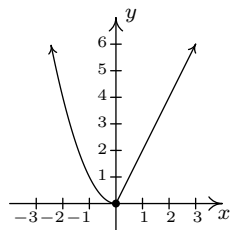

15.

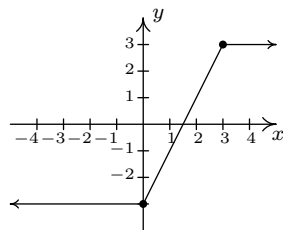

16.

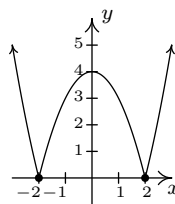

17.

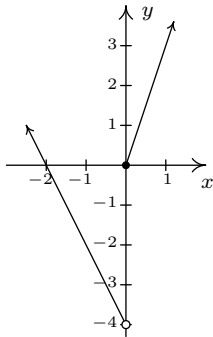

18.

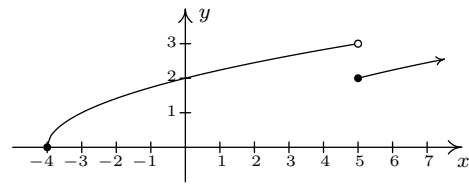

19.

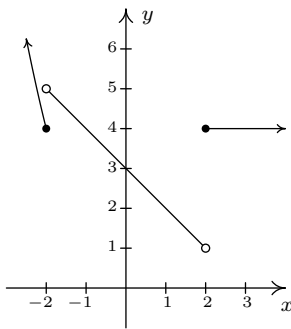

20.

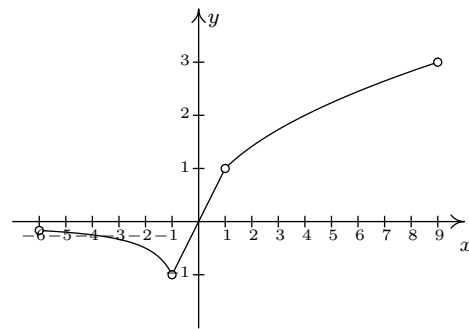

21. odd

22. neither

23. even

24. even

25. even

26. neither

27. odd

28. odd

29. even

30. neither

31. neither

32. even

33. even **and** odd

34. odd

35. even

36. even

37. neither

38. odd

39. odd

40. even

41. even

42. $[-5, 3]$

43. $[-5, 4]$

44. $f(-2) = 2$

45. $x = -3$

46. $(-4, 0), (-1, 0), (1, 0)$

47. $(0, -1)$

48. $-4, -1, 1$

49. $[-4, -1] \cup [1, 3]$

50. 4

51. neither
52. $[-5, -3], [0, 2]$
53. $[-3, 0], [2, 3]$
54. $f(-3) = 4, f(2) = 3$
55. $f(0) = -1$
56. $f(-3) = 4$
57. $f(-5) = -5$
58. $[-4, 4]$
59. $[-5, 5]$
60. $f(2) = 3$
61. $x = -2$
62. $(-4, 0), (0, 0), (4, 0)$
63. $(0, 0)$
64. $-4, 0, 4$
65. $[-4, 0] \cup \{4\}$
66. 3
67. neither
68. $[-2, 2]$
69. $[-4, -2], (2, 4]$
70. none
71. $f(-2) = -5, f(2) = 3$
72. none
73. $f(-2) = -5$
74. No absolute maximum
 Absolute minimum $f(4.55) \approx -175.46$
 Local minimum at $(-2.84, -91.32)$
 Local maximum at $(0.54, 55.73)$
 Local minimum at $(4.55, -175.46)$
 Increasing on $[-2.84, 0.54], [4.55, \infty)$
 Decreasing on $(-\infty, -2.84], [0.54, 4.55]$
75. No absolute maximum
 No absolute minimum
 Local maximum at $(0, 0)$
 Local minimum at $(1.60, -3.28)$
 Increasing on $(-\infty, 0], [1.60, \infty)$
 Decreasing on $[0, 1.60]$
76. Absolute maximum $f(0) = 3$
 Absolute minimum $f(\pm 3) = 0$
 Local maximum at $(0, 3)$
 No local minimum
 Increasing on $[-3, 0]$
 Decreasing on $[0, 3]$
77. Absolute maximum $f(2.12) \approx 4.50$
 Absolute minimum $f(-2.12) \approx -4.50$
 Local maximum $(2.12, 4.50)$
 Local minimum $(-2.12, -4.50)$
 Increasing on $[-2.12, 2.12]$
 Decreasing on $[-3, -2.12], [2.12, 3]$
78. $(f + g)(0) = 4$
79. $(f + g)(1) = 5$
80. $(f - g)(1) = -1$
81. $(g - f)(2) = 0$
82. $(fg)(2) = 9$
83. $(fg)(1) = 6$
84. $\left(\frac{f}{g}\right)(4) = 0$
85. $\left(\frac{g}{f}\right)(2) = 1$
86. $h(0) = 2$, so the Sasquatch is 2 feet tall at birth.
87. $h(15) = 6$, so the Saquatch is 6 feet tall when she is 15 years old.
88. $h(N) = 6$ when $N = 15$ and $N = 60$. This means the Sasquatch is 6 feet tall when she is 15 and 60 years old.
89. h is constant on $[30, 45]$. This means the Sasquatch's height is constant (at 8 feet) for these years.

90. h is decreasing on $[45, 60]$. This means the Sasquatch is getting shorter from the age of 45 to the age of 60. (Sasquatchteoporosis, perhaps?)

91.

92. Note that $f(1.1) = 1$, but $f(-1.1) = -2$, so f is neither even nor odd.

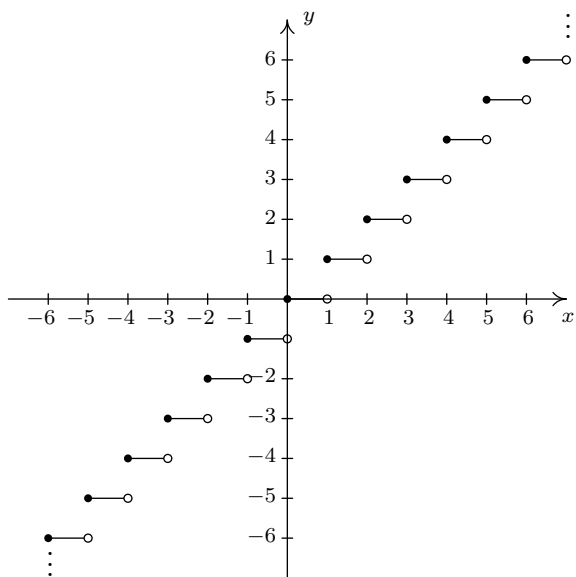

The graph of $f(x) = [x]$.

1.7 TRANSFORMATIONS

In this section, we study how the graphs of functions change, or **transform**, when certain specialized modifications are made to their formulas. The transformations we will study fall into three broad categories: shifts, reflections and scalings, and we will present them in that order. Suppose the graph below is the complete graph of a function f .

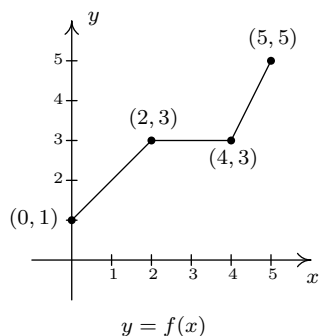

The Fundamental Graphing Principle for Functions says that for a point (a, b) to be on the graph, $f(a) = b$. In particular, we know $f(0) = 1$, $f(2) = 3$, $f(4) = 3$ and $f(5) = 5$. Suppose we wanted to graph the function defined by the formula $g(x) = f(x) + 2$. Let's take a minute to remind ourselves of what g is doing. We start with an input x to the function f and we obtain the output $f(x)$. The function g takes the output $f(x)$ and adds 2 to it. In order to graph g , we need to graph the points $(x, g(x))$. How are we to find the values for $g(x)$ without a formula for $f(x)$? The answer is that we don't need a *formula* for $f(x)$, we just need the *values* of $f(x)$. The values of $f(x)$ are the y values on the graph of $y = f(x)$. For example, using the points indicated on the graph of f , we can make the following table.

x	$(x, f(x))$	$f(x)$	$g(x) = f(x) + 2$	$(x, g(x))$
0	(0, 1)	1	3	(0, 3)
2	(2, 3)	3	5	(2, 5)
4	(4, 3)	3	5	(4, 5)
5	(5, 5)	5	7	(5, 7)

In general, if (a, b) is on the graph of $y = f(x)$, then $f(a) = b$, so $g(a) = f(a) + 2 = b + 2$. Hence, $(a, b + 2)$ is on the graph of g . In other words, to obtain the graph of g , we add 2 to the y -coordinate of each point on the graph of f . Geometrically, adding 2 to the y -coordinate of a point moves the point 2 units above its previous location. Adding 2 to every y -coordinate on a graph *en masse* is usually described as 'shifting the graph up 2 units'. Notice that the graph retains the same basic shape as before, it is just 2 units above its original location. In other words, we connect the four points we moved in the same manner in which they were connected before. We have the results side-by-side at the top of the next page.

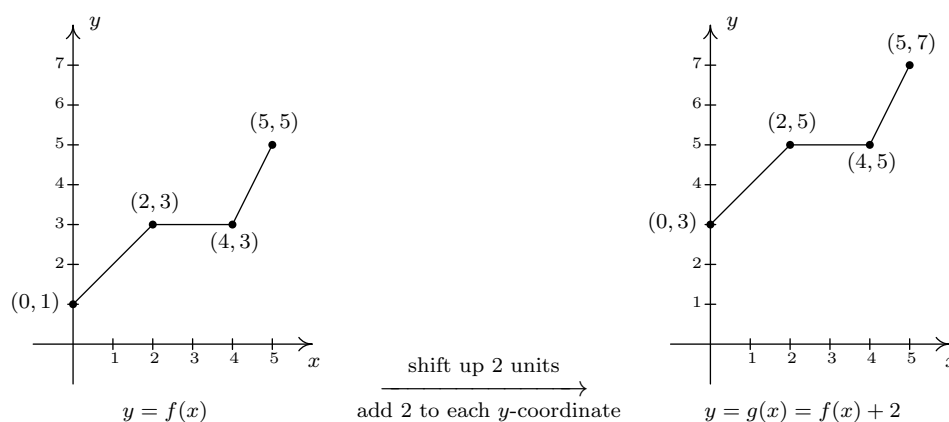

You'll note that the domain of f and the domain of g are the same, namely $[0, 5]$, but that the range of f is $[1, 5]$ while the range of g is $[3, 7]$. In general, shifting a function vertically like this will leave the domain unchanged, but could very well affect the range. You can easily imagine what would happen if we wanted to graph the function $j(x) = f(x) - 2$. Instead of adding 2 to each of the y -coordinates on the graph of f , we'd be subtracting 2. Geometrically, we would be moving the graph down 2 units. We leave it to the reader to verify that the domain of j is the same as f , but the range of j is $[-1, 3]$. What we have discussed is generalized in the following theorem.

Theorem 1.2. Vertical Shifts. Suppose f is a function and k is a positive number.

- To graph $y = f(x) + k$, shift the graph of $y = f(x)$ up k units by adding k to the y -coordinates of the points on the graph of f .
- To graph $y = f(x) - k$, shift the graph of $y = f(x)$ down k units by subtracting k from the y -coordinates of the points on the graph of f .

The key to understanding Theorem 1.2 and, indeed, all of the theorems in this section comes from an understanding of the Fundamental Graphing Principle for Functions. If (a, b) is on the graph of f , then $f(a) = b$. Substituting $x = a$ into the equation $y = f(x) + k$ gives $y = f(a) + k = b + k$. Hence, $(a, b + k)$ is on the graph of $y = f(x) + k$, and we have the result. In the language of 'inputs' and 'outputs', Theorem 1.2 can be paraphrased as "Adding to, or subtracting from, the *output* of a function causes the graph to shift up or down, respectively." So what happens if we add to or subtract from the *input* of the function?

Keeping with the graph of $y = f(x)$ above, suppose we wanted to graph $g(x) = f(x + 2)$. In other words, we are looking to see what happens when we add 2 to the input of the function.¹ Let's try to generate a table of values of g based on those we know for f . We quickly find that we run into some difficulties.

¹We have spent a lot of time in this text showing you that $f(x + 2)$ and $f(x) + 2$ are, in general, wildly different algebraic animals. We will see momentarily that their geometry is also dramatically different.

x	$(x, f(x))$	$f(x)$	$g(x) = f(x + 2)$	$(x, g(x))$
0	(0, 1)	1	$f(0 + 2) = f(2) = 3$	(0, 3)
2	(2, 3)	3	$f(2 + 2) = f(4) = 3$	(2, 3)
4	(4, 3)	3	$f(4 + 2) = f(6) = ?$	
5	(5, 5)	5	$f(5 + 2) = f(7) = ?$	

When we substitute $x = 4$ into the formula $g(x) = f(x + 2)$, we are asked to find $f(4 + 2) = f(6)$ which doesn't exist because the domain of f is only $[0, 5]$. The same thing happens when we attempt to find $g(5)$. What we need here is a new strategy. We know, for instance, $f(0) = 1$. To determine the corresponding point on the graph of g , we need to figure out what value of x we must substitute into $g(x) = f(x + 2)$ so that the quantity $x + 2$, works out to be 0. Solving $x + 2 = 0$ gives $x = -2$, and $g(-2) = f((-2) + 2) = f(0) = 1$ so $(-2, 1)$ is on the graph of g . To use the fact $f(2) = 3$, we set $x + 2 = 2$ to get $x = 0$. Substituting gives $g(0) = f(0 + 2) = f(2) = 3$. Continuing in this fashion, we get

x	$x + 2$	$g(x) = f(x + 2)$	$(x, g(x))$
-2	0	$g(-2) = f(0) = 1$	$(-2, 1)$
0	2	$g(0) = f(2) = 3$	$(0, 3)$
2	4	$g(2) = f(4) = 3$	$(2, 3)$
3	5	$g(3) = f(5) = 5$	$(3, 5)$

In summary, the points $(0, 1)$, $(2, 3)$, $(4, 3)$ and $(5, 5)$ on the graph of $y = f(x)$ give rise to the points $(-2, 1)$, $(0, 3)$, $(2, 3)$ and $(3, 5)$ on the graph of $y = g(x)$, respectively. In general, if (a, b) is on the graph of $y = f(x)$, then $f(a) = b$. Solving $x + 2 = a$ gives $x = a - 2$ so that $g(a - 2) = f((a - 2) + 2) = f(a) = b$. As such, $(a - 2, b)$ is on the graph of $y = g(x)$. The point $(a - 2, b)$ is exactly 2 units to the *left* of the point (a, b) so the graph of $y = g(x)$ is obtained by shifting the graph $y = f(x)$ to the left 2 units, as pictured below.

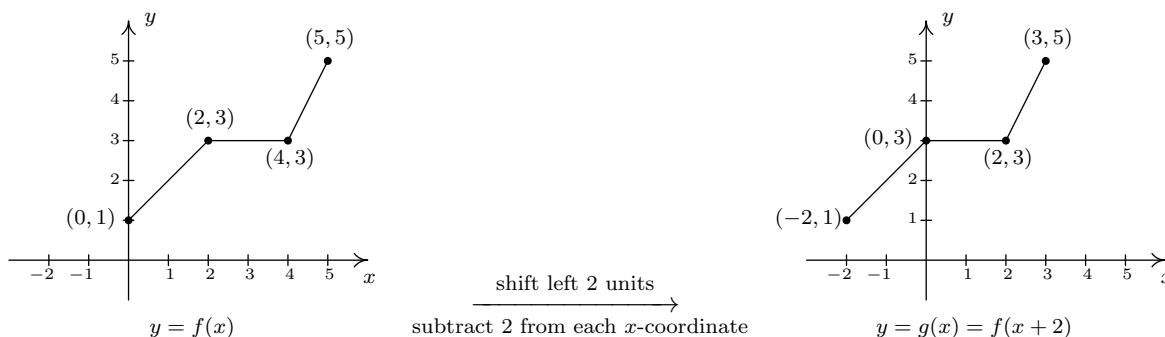

Note that while the ranges of f and g are the same, the domain of g is $[-2, 3]$ whereas the domain of f is $[0, 5]$. In general, when we shift the graph horizontally, the range will remain the same, but the domain could change. If we set out to graph $j(x) = f(x - 2)$, we would find ourselves *adding*

2 to all of the x values of the points on the graph of $y = f(x)$ to effect a shift to the *right* 2 units. Generalizing these notions produces the following result.

Theorem 1.3. Horizontal Shifts. Suppose f is a function and h is a positive number.

- To graph $y = f(x + h)$, shift the graph of $y = f(x)$ left h units by subtracting h from the x -coordinates of the points on the graph of f .
- To graph $y = f(x - h)$, shift the graph of $y = f(x)$ right h units by adding h to the x -coordinates of the points on the graph of f .

In other words, Theorem 1.3 says that adding to or subtracting from the *input* to a function amounts to shifting the graph left or right, respectively. Theorems 1.2 and 1.3 present a theme which will run common throughout the section: changes to the outputs from a function affect the y -coordinates of the graph, resulting in some kind of vertical change; changes to the inputs to a function affect the x -coordinates of the graph, resulting in some kind of horizontal change.

Example 1.7.1.

1. Graph $f(x) = \sqrt{x}$. Plot at least three points.
2. Use your graph in 1 to graph $g(x) = \sqrt{x} - 1$.
3. Use your graph in 1 to graph $j(x) = \sqrt{x - 1}$.
4. Use your graph in 1 to graph $m(x) = \sqrt{x + 3} - 2$.

Solution.

1. Owing to the square root, the domain of f is $x \geq 0$, or $[0, \infty)$. We choose perfect squares to build our table and graph below. From the graph we verify the domain of f is $[0, \infty)$ and the range of f is also $[0, \infty)$.

x	$f(x)$	$(x, f(x))$
0	0	(0, 0)
1	1	(1, 1)
4	2	(4, 2)

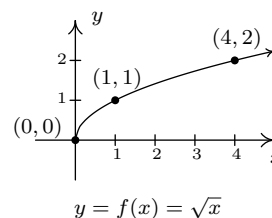

2. The domain of g is the same as the domain of f , since the only condition on both functions is that $x \geq 0$. If we compare the formula for $g(x)$ with $f(x)$, we see that $g(x) = f(x) - 1$. In other words, we have subtracted 1 from the output of the function f . By Theorem 1.2, we know that in order to graph g , we shift the graph of f down one unit by subtracting 1 from each of the y -coordinates of the points on the graph of f . Applying this to the three points we have specified on the graph, we move $(0, 0)$ to $(0, -1)$, $(1, 1)$ to $(1, 0)$, and $(4, 2)$ to $(4, 1)$.

The rest of the points follow suit, and we connect them with the same basic shape as before. We confirm the domain of g is $[0, \infty)$ and find the range of g to be $[-1, \infty)$.

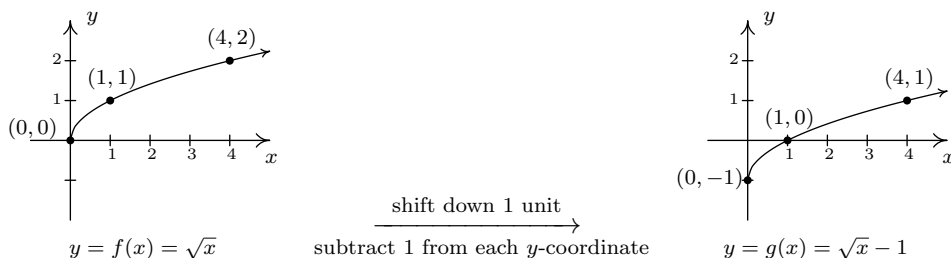

3. Solving $x - 1 \geq 0$ gives $x \geq 1$, so the domain of j is $[1, \infty)$. To graph j , we note that $j(x) = f(x - 1)$. In other words, we are subtracting 1 from the *input* of f . According to Theorem 1.3, this induces a shift to the right of the graph of f . We add 1 to the x -coordinates of the points on the graph of f and get the result below. The graph reaffirms that the domain of j is $[1, \infty)$ and tells us that the range of j is $[0, \infty)$.

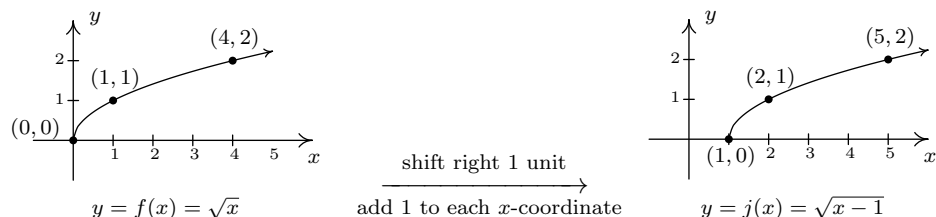

4. To find the domain of m , we solve $x + 3 \geq 0$ and get $[-3, \infty)$. Comparing the formulas of $f(x)$ and $m(x)$, we have $m(x) = f(x + 3) - 2$. We have 3 being added to an input, indicating a horizontal shift, and 2 being subtracted from an output, indicating a vertical shift. We leave it to the reader to verify that, in this particular case, the order in which we perform these transformations is immaterial; we will arrive at the same graph regardless as to which transformation we apply first.² We follow the convention ‘inputs first’,³ and to that end we first tackle the horizontal shift. Letting $m_1(x) = f(x + 3)$ denote this intermediate step, Theorem 1.3 tells us that the graph of $y = m_1(x)$ is the graph of f shifted to the left 3 units. Hence, we subtract 3 from each of the x -coordinates of the points on the graph of f .

²We shall see in the next example that order is generally important when applying more than one transformation to a graph.

³We could equally have chosen the convention ‘outputs first’.

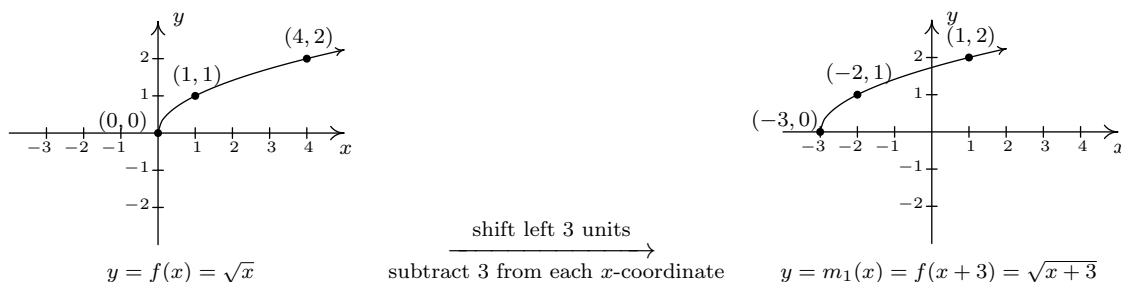

Since $m(x) = f(x+3) - 2$ and $f(x+3) = m_1(x)$, we have $m(x) = m_1(x) - 2$. We can apply Theorem 1.2 and obtain the graph of m by subtracting 2 from the y -coordinates of each of the points on the graph of $m_1(x)$. The graph verifies that the domain of m is $[-3, \infty)$ and we find the range of m to be $[-2, \infty)$.

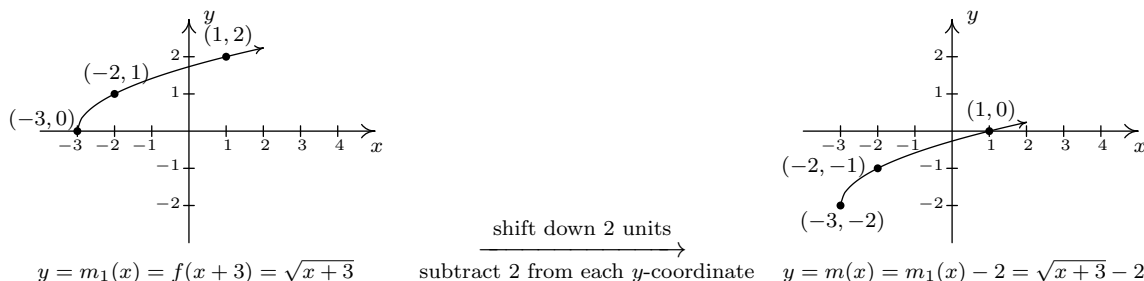

Keep in mind that we can check our answer to any of these kinds of problems by showing that any of the points we've moved lie on the graph of our final answer. For example, we can check that $(-3, -2)$ is on the graph of m by computing $m(-3) = \sqrt{(-3)+3} - 2 = \sqrt{0} - 2 = -2 \checkmark$ \square

We now turn our attention to reflections. We know from Section 1.1 that to reflect a point (x, y) across the x -axis, we replace y with $-y$. If (x, y) is on the graph of f , then $y = f(x)$, so replacing y with $-y$ is the same as replacing $f(x)$ with $-f(x)$. Hence, the graph of $y = -f(x)$ is the graph of f reflected across the x -axis. Similarly, the graph of $y = f(-x)$ is the graph of f reflected across the y -axis. Returning to the language of inputs and outputs, multiplying the output from a function by -1 reflects its graph across the x -axis, while multiplying the input to a function by -1 reflects the graph across the y -axis.⁴

⁴The expressions $-f(x)$ and $f(-x)$ should look familiar - they are the quantities we used in Section 1.6 to test if a function was even, odd or neither. The interested reader is invited to explore the role of reflections and symmetry of functions. What happens if you reflect an even function across the y -axis? What happens if you reflect an odd function across the y -axis? What about the x -axis?

Theorem 1.4. Reflections. Suppose f is a function.

- To graph $y = -f(x)$, reflect the graph of $y = f(x)$ across the x -axis by multiplying the y -coordinates of the points on the graph of f by -1 .
- To graph $y = f(-x)$, reflect the graph of $y = f(x)$ across the y -axis by multiplying the x -coordinates of the points on the graph of f by -1 .

Applying Theorem 1.4 to the graph of $y = f(x)$ given at the beginning of the section, we can graph $y = -f(x)$ by reflecting the graph of f about the x -axis

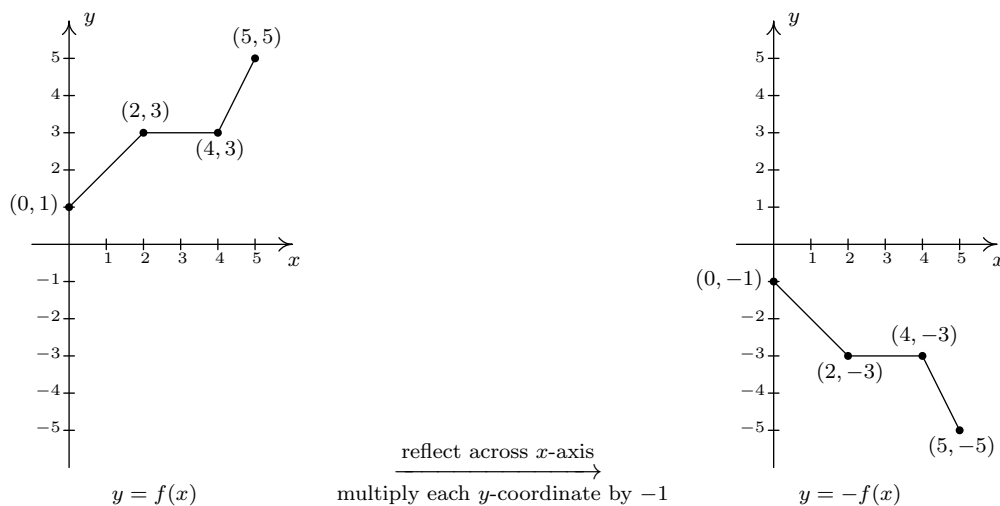

By reflecting the graph of f across the y -axis, we obtain the graph of $y = f(-x)$.

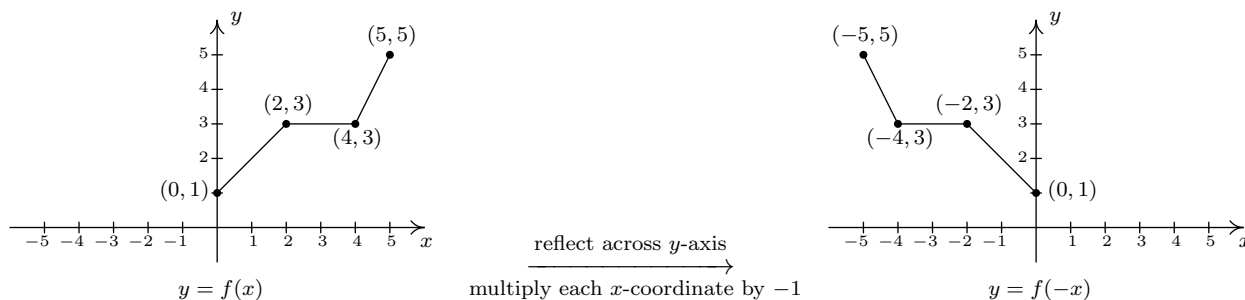

With the addition of reflections, it is now more important than ever to consider the order of transformations, as the next example illustrates.

Example 1.7.2. Let $f(x) = \sqrt{x}$. Use the graph of f from Example 1.7.1 to graph the following functions. Also, state their domains and ranges.

1. $g(x) = \sqrt{-x}$

2. $j(x) = \sqrt{3-x}$

3. $m(x) = 3 - \sqrt{x}$

Solution.

1. The mere sight of $\sqrt{-x}$ usually causes alarm, if not panic. When we discussed domains in Section 1.4, we clearly banished negatives from the radicands of even roots. However, we must remember that x is a variable, and as such, the quantity $-x$ isn't always negative. For example, if $x = -4$, $-x = 4$, thus $\sqrt{-x} = \sqrt{-(-4)} = 2$ is perfectly well-defined. To find the domain analytically, we set $-x \geq 0$ which gives $x \leq 0$, so that the domain of g is $(-\infty, 0]$. Since $g(x) = f(-x)$, Theorem 1.4 tells us that the graph of g is the reflection of the graph of f across the y -axis. We accomplish this by multiplying each x -coordinate on the graph of f by -1 , so that the points $(0, 0)$, $(1, 1)$, and $(4, 2)$ move to $(0, 0)$, $(-1, 1)$, and $(-4, 2)$, respectively. Graphically, we see that the domain of g is $(-\infty, 0]$ and the range of g is the same as the range of f , namely $[0, \infty)$.

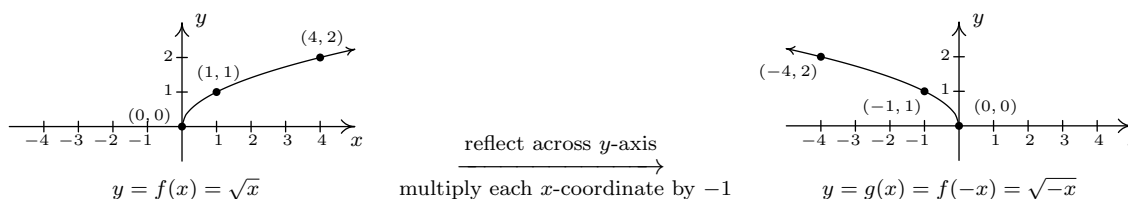

2. To determine the domain of $j(x) = \sqrt{3-x}$, we solve $3-x \geq 0$ and get $x \leq 3$, or $(-\infty, 3]$. To determine which transformations we need to apply to the graph of f to obtain the graph of j , we rewrite $j(x) = \sqrt{-x+3} = f(-x+3)$. Comparing this formula with $f(x) = \sqrt{x}$, we see that not only are we multiplying the input x by -1 , which results in a reflection across the y -axis, but also we are adding 3, which indicates a horizontal shift to the left. Does it matter in which order we do the transformations? If so, which order is the correct order? Let's consider the point $(4, 2)$ on the graph of f . We refer to the discussion leading up to Theorem 1.3. We know $f(4) = 2$ and wish to find the point on $y = j(x) = f(-x+3)$ which corresponds to $(4, 2)$. We set $-x+3 = 4$ and solve. Our first step is to subtract 3 from both sides to get $-x = 1$. Subtracting 3 from the x -coordinate 4 is shifting the point $(4, 2)$ to the left. From $-x = 1$, we then multiply⁵ both sides by -1 to get $x = -1$. Multiplying the x -coordinate by -1 corresponds to reflecting the point about the y -axis. Hence, we perform the horizontal shift first, then follow it with the reflection about the y -axis. Starting with $f(x) = \sqrt{x}$, we let $j_1(x)$ be the intermediate function which shifts the graph of f 3 units to the left, $j_1(x) = f(x+3)$.

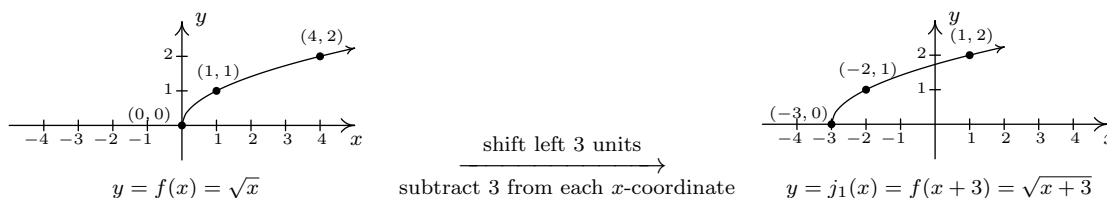

⁵Or divide - it amounts to the same thing.

To obtain the function j , we reflect the graph of j_1 about y -axis. Theorem 1.4 tells us we have $j(x) = j_1(-x)$. Putting it all together, we have $j(x) = j_1(-x) = f(-x + 3) = \sqrt{-x + 3}$, which is what we want.⁶ From the graph, we confirm the domain of j is $(-\infty, 3]$ and we get that the range is $[0, \infty)$.

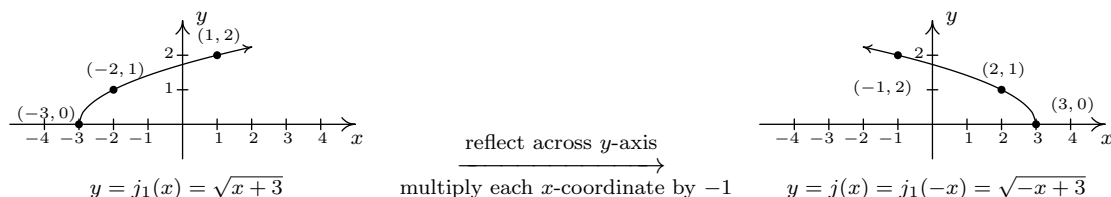

3. The domain of m works out to be the domain of f , $[0, \infty)$. Rewriting $m(x) = -\sqrt{x} + 3$, we see $m(x) = -f(x) + 3$. Since we are multiplying the output of f by -1 and then adding 3 , we once again have two transformations to deal with: a reflection across the x -axis and a vertical shift. To determine the correct order in which to apply the transformations, we imagine trying to determine the point on the graph of m which corresponds to $(4, 2)$ on the graph of f . Since in the formula for $m(x)$, the input to f is just x , we substitute to find $m(4) = -f(4) + 3 = -2 + 3 = 1$. Hence, $(4, 1)$ is the corresponding point on the graph of m . If we closely examine the arithmetic, we see that we first multiply $f(4)$ by -1 , which corresponds to the reflection across the x -axis, and then we add 3 , which corresponds to the vertical shift. If we define an intermediate function $m_1(x) = -f(x)$ to take care of the reflection, we get

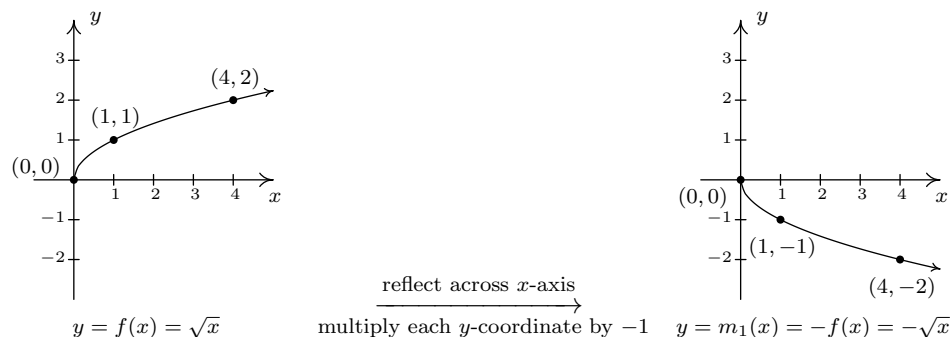

To shift the graph of m_1 up 3 units, we set $m(x) = m_1(x) + 3$. Since $m_1(x) = -f(x)$, when we put it all together, we get $m(x) = m_1(x) + 3 = -f(x) + 3 = -\sqrt{x} + 3$. We see from the graph that the range of m is $(-\infty, 3]$.

⁶If we had done the reflection first, then $j_1(x) = f(-x)$. Following this by a shift left would give us $j(x) = j_1(x+3) = f(-(x+3)) = f(-x-3) = \sqrt{-x-3}$ which isn't what we want. However, if we did the reflection first and followed it by a shift to the right 3 units, we would have arrived at the function $j(x)$. We leave it to the reader to verify the details.

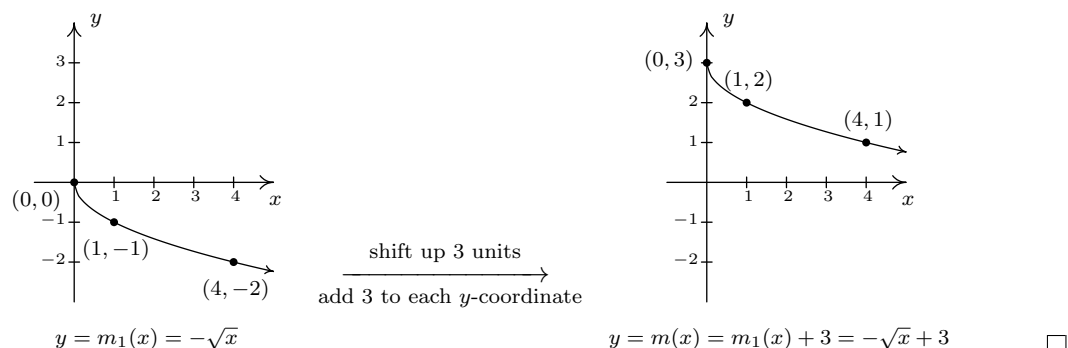

We now turn our attention to our last class of transformations known as **scalings**. A thorough discussion of scalings can get complicated because they are not as straight-forward as the previous transformations. A quick review of what we've covered so far, namely vertical shifts, horizontal shifts and reflections, will show you why those transformations are known as **rigid transformations**. Simply put, they do not change the *shape* of the graph, only its position and orientation in the plane. If, however, we wanted to make a new graph twice as tall as a given graph, or one-third as wide, we would be changing the shape of the graph. This type of transformation is called **non-rigid** for obvious reasons. Not only will it be important for us to differentiate between modifying inputs versus outputs, we must also pay close attention to the magnitude of the changes we make. As you will see shortly, the Mathematics turns out to be easier than the associated grammar.

Suppose we wish to graph the function $g(x) = 2f(x)$ where $f(x)$ is the function whose graph is given at the beginning of the section. From its graph, we can build a table of values for g as before.

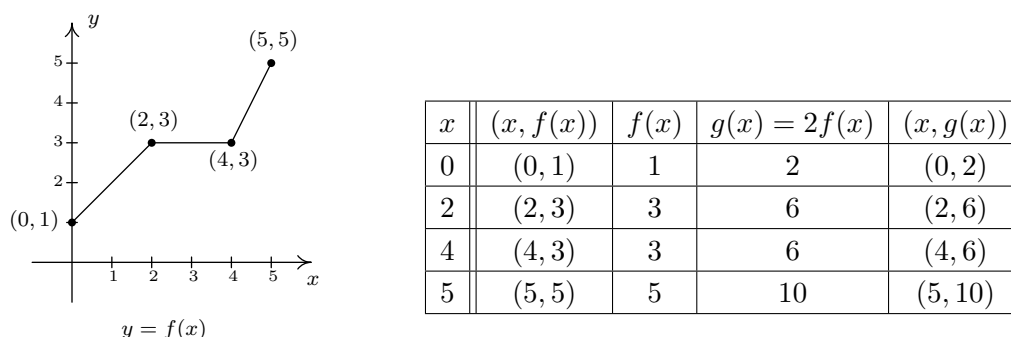

In general, if (a, b) is on the graph of f , then $f(a) = b$ so that $g(a) = 2f(a) = 2b$ puts $(a, 2b)$ on the graph of g . In other words, to obtain the graph of g , we multiply all of the y -coordinates of the points on the graph of f by 2. Multiplying all of the y -coordinates of all of the points on the graph of f by 2 causes what is known as a 'vertical scaling'⁷ by a factor of 2, and the results are given on the next page.

⁷Also called a 'vertical stretching', 'vertical expansion' or 'vertical dilation' by a factor of 2.

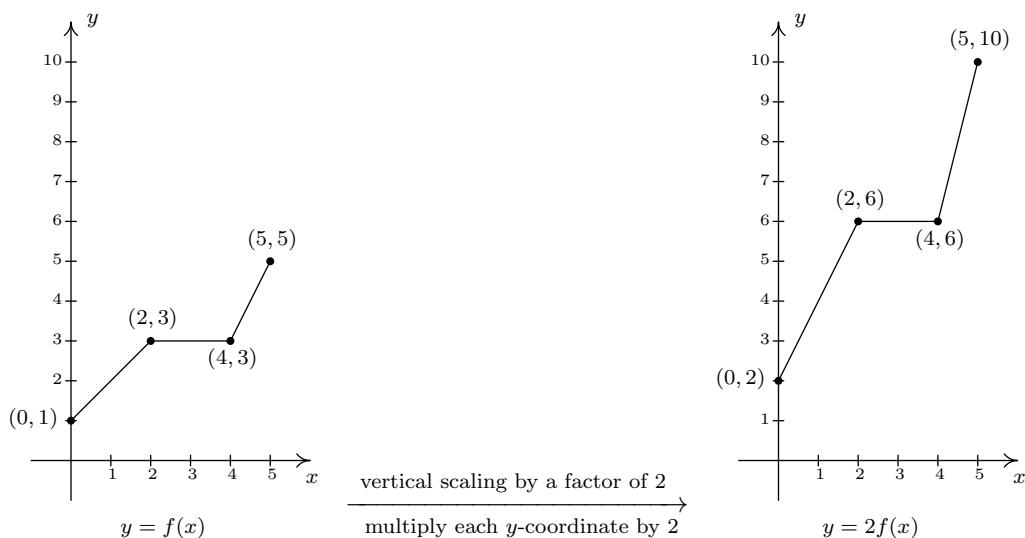

If we wish to graph $y = \frac{1}{2}f(x)$, we multiply all of the y -coordinates of the points on the graph of f by $\frac{1}{2}$. This creates a ‘vertical scaling⁸ by a factor of $\frac{1}{2}$ ’, as seen below.

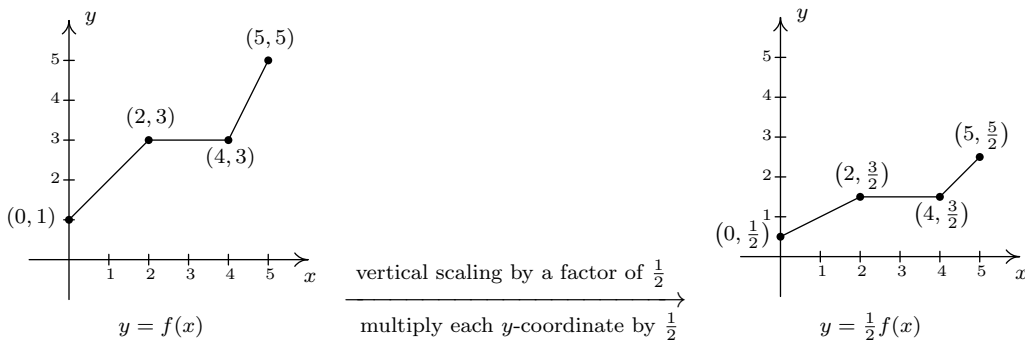

These results are generalized in the following theorem.

Theorem 1.5. Vertical Scalings. Suppose f is a function and $a > 0$. To graph $y = af(x)$, multiply all of the y -coordinates of the points on the graph of f by a . We say the graph of f has been vertically scaled by a factor of a .

- If $a > 1$, we say the graph of f has undergone a vertical stretching (expansion, dilation) by a factor of a .
- If $0 < a < 1$, we say the graph of f has undergone a vertical shrinking (compression, contraction) by a factor of $\frac{1}{a}$.

⁸Also called ‘vertical shrinking’, ‘vertical compression’ or ‘vertical contraction’ by a factor of 2.

A few remarks about Theorem 1.5 are in order. First, a note about the verbiage. To the authors, the words ‘stretching’, ‘expansion’, and ‘dilation’ all indicate something getting bigger. Hence, ‘stretched by a factor of 2’ makes sense if we are scaling something by multiplying it by 2. Similarly, we believe words like ‘shrinking’, ‘compression’ and ‘contraction’ all indicate something getting smaller, so if we scale something by a factor of $\frac{1}{2}$, we would say it ‘shrinks by a factor of 2’ - not ‘shrinks by a factor of $\frac{1}{2}$ ’. This is why we have written the descriptions ‘stretching by a factor of a ’ and ‘shrinking by a factor of $\frac{1}{a}$ ’ in the statement of the theorem. Second, in terms of inputs and outputs, Theorem 1.5 says multiplying the *outputs* from a function by positive number a causes the graph to be vertically scaled by a factor of a . It is natural to ask what would happen if we multiply the *inputs* of a function by a positive number. This leads us to our last transformation of the section.

Referring to the graph of f given at the beginning of this section, suppose we want to graph $g(x) = f(2x)$. In other words, we are looking to see what effect multiplying the inputs to f by 2 has on its graph. If we attempt to build a table directly, we quickly run into the same problem we had in our discussion leading up to Theorem 1.3, as seen in the table on the left below. We solve this problem in the same way we solved this problem before. For example, if we want to determine the point on g which corresponds to the point $(2, 3)$ on the graph of f , we set $2x = 2$ so that $x = 1$. Substituting $x = 1$ into $g(x)$, we obtain $g(1) = f(2 \cdot 1) = f(2) = 3$, so that $(1, 3)$ is on the graph of g . Continuing in this fashion, we obtain the table on the lower right.

x	$(x, f(x))$	$f(x)$	$g(x) = f(2x)$	$(x, g(x))$
0	(0, 1)	1	$f(2 \cdot 0) = f(0) = 1$	(0, 1)
2	(2, 3)	3	$f(2 \cdot 2) = f(4) = 3$	(2, 3)
4	(4, 3)	3	$f(2 \cdot 4) = f(8) = ?$	
5	(5, 5)	5	$f(2 \cdot 5) = f(10) = ?$	

x	$2x$	$g(x) = f(2x)$	$(x, g(x))$
0	0	$g(0) = f(0) = 1$	(0, 1)
1	2	$g(1) = f(2) = 3$	(1, 3)
2	4	$g(2) = f(4) = 3$	(2, 3)
$\frac{5}{2}$	5	$g(\frac{5}{2}) = f(5) = 5$	$(\frac{5}{2}, 5)$

In general, if (a, b) is on the graph of f , then $f(a) = b$. Hence $g(\frac{a}{2}) = f(2 \cdot \frac{a}{2}) = f(a) = b$ so that $(\frac{a}{2}, b)$ is on the graph of g . In other words, to graph g we divide the x -coordinates of the points on the graph of f by 2. This results in a horizontal scaling⁹ by a factor of $\frac{1}{2}$.

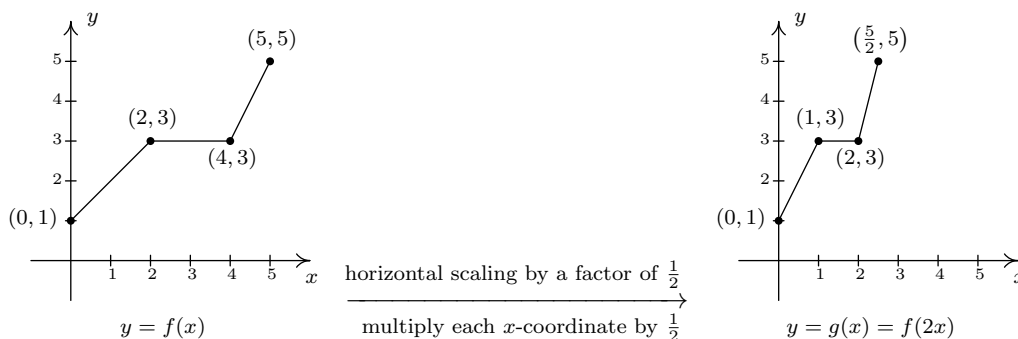

⁹Also called ‘horizontal shrinking’, ‘horizontal compression’ or ‘horizontal contraction’ by a factor of 2.

If, on the other hand, we wish to graph $y = f\left(\frac{1}{2}x\right)$, we end up multiplying the x -coordinates of the points on the graph of f by 2 which results in a horizontal scaling¹⁰ by a factor of 2, as demonstrated below.

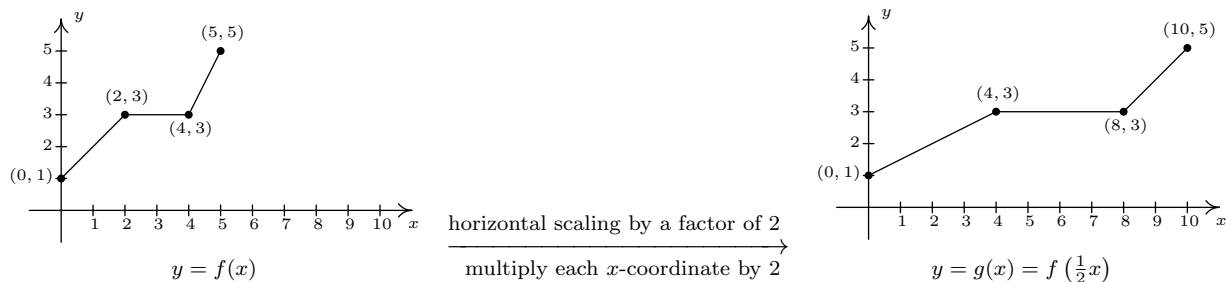

We have the following theorem.

Theorem 1.6. Horizontal Scalings. Suppose f is a function and $b > 0$. To graph $y = f(bx)$, divide all of the x -coordinates of the points on the graph of f by b . We say the graph of f has been horizontally scaled by a factor of $\frac{1}{b}$.

- If $0 < b < 1$, we say the graph of f has undergone a horizontal stretching (expansion, dilation) by a factor of $\frac{1}{b}$.
- If $b > 1$, we say the graph of f has undergone a horizontal shrinking (compression, contraction) by a factor of b .

Theorem 1.6 tells us that if we multiply the input to a function by b , the resulting graph is scaled horizontally by a factor of $\frac{1}{b}$ since the x -values are divided by b to produce corresponding points on the graph of $y = f(bx)$. The next example explores how vertical and horizontal scalings sometimes interact with each other and with the other transformations introduced in this section.

Example 1.7.3. Let $f(x) = \sqrt{x}$. Use the graph of f from Example 1.7.1 to graph the following functions. Also, state their domains and ranges.

1. $g(x) = 3\sqrt{x}$
2. $j(x) = \sqrt{9x}$
3. $m(x) = 1 - \sqrt{\frac{x+3}{2}}$

Solution.

1. First we note that the domain of g is $[0, \infty)$ for the usual reason. Next, we have $g(x) = 3f(x)$ so by Theorem 1.5, we obtain the graph of g by multiplying all of the y -coordinates of the points on the graph of f by 3. The result is a vertical scaling of the graph of f by a factor of 3. We find the range of g is also $[0, \infty)$.

¹⁰Also called ‘horizontal stretching’, ‘horizontal expansion’ or ‘horizontal dilation’ by a factor of 2.

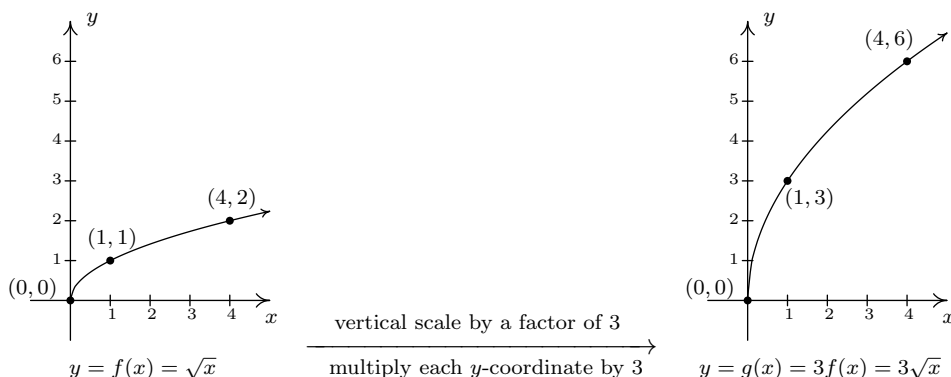

2. To determine the domain of j , we solve $9x \geq 0$ to find $x \geq 0$. Our domain is once again $[0, \infty)$. We recognize $j(x) = f(9x)$ and by Theorem 1.6, we obtain the graph of j by dividing the x -coordinates of the points on the graph of f by 9. From the graph, we see the range of j is also $[0, \infty)$.

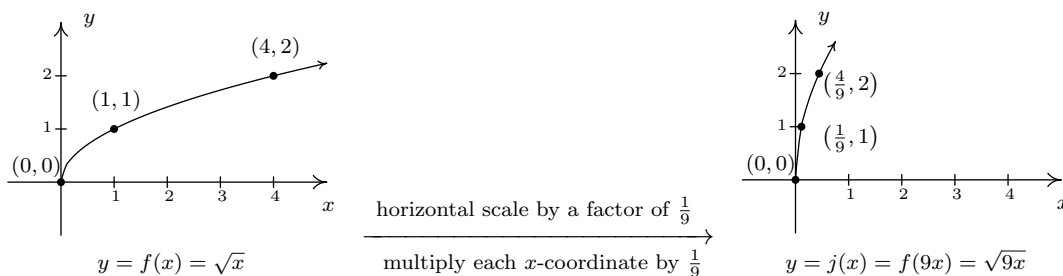

3. Solving $\frac{x+3}{2} \geq 0$ gives $x \geq -3$, so the domain of m is $[-3, \infty)$. To take advantage of what we know of transformations, we rewrite $m(x) = -\sqrt{\frac{1}{2}x + \frac{3}{2}} + 1$, or $m(x) = -f\left(\frac{1}{2}x + \frac{3}{2}\right) + 1$. Focusing on the inputs first, we note that the input to f in the formula for $m(x)$ is $\frac{1}{2}x + \frac{3}{2}$. Multiplying the x by $\frac{1}{2}$ corresponds to a horizontal stretching by a factor of 2, and adding the $\frac{3}{2}$ corresponds to a shift to the left by $\frac{3}{2}$. As before, we resolve which to perform first by thinking about how we would find the point on m corresponding to a point on f , in this case, $(4, 2)$. To use $f(4) = 2$, we solve $\frac{1}{2}x + \frac{3}{2} = 4$. Our first step is to subtract the $\frac{3}{2}$ (the horizontal shift) to obtain $\frac{1}{2}x = \frac{5}{2}$. Next, we multiply by 2 (the horizontal stretching) and obtain $x = 5$. We define two intermediate functions to handle first the shift, then the stretching. In accordance with Theorem 1.3, $m_1(x) = f\left(x + \frac{3}{2}\right) = \sqrt{x + \frac{3}{2}}$ will shift the graph of f to the left $\frac{3}{2}$ units.

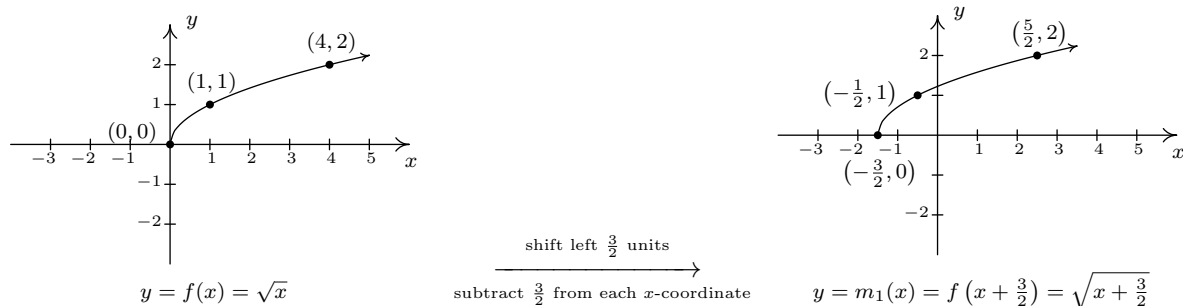

Next, $m_2(x) = m_1\left(\frac{1}{2}x\right) = \sqrt{\frac{1}{2}x + \frac{3}{2}}$ will, according to Theorem 1.6, horizontally stretch the graph of m_1 by a factor of 2.

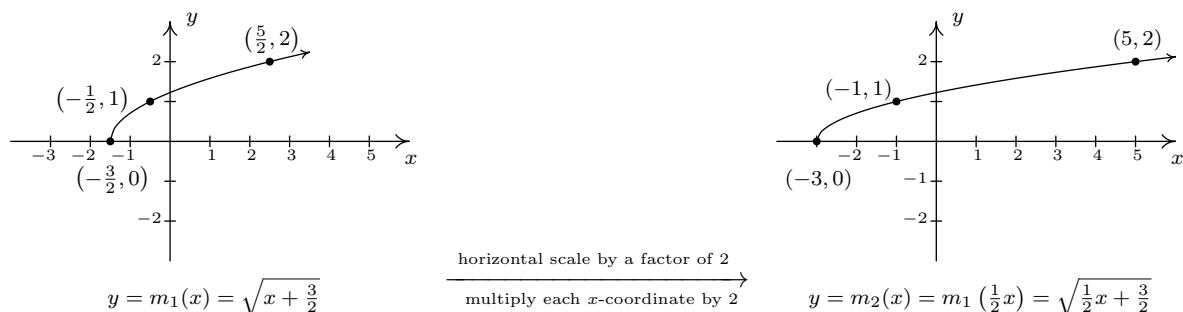

We now examine what's happening to the outputs. From $m(x) = -f\left(\frac{1}{2}x + \frac{3}{2}\right) + 1$, we see that the output from f is being multiplied by -1 (a reflection about the x -axis) and then a 1 is added (a vertical shift up 1). As before, we can determine the correct order by looking at how the point $(4, 2)$ is moved. We already know that to make use of the equation $f(4) = 2$, we need to substitute $x = 5$. We get $m(5) = -f\left(\frac{1}{2}(5) + \frac{3}{2}\right) + 1 = -f(4) + 1 = -2 + 1 = -1$. We see that $f(4)$ (the output from f) is first multiplied by -1 then the 1 is added meaning we first reflect the graph about the x -axis then shift up 1. Theorem 1.4 tells us $m_3(x) = -m_2(x)$ will handle the reflection.

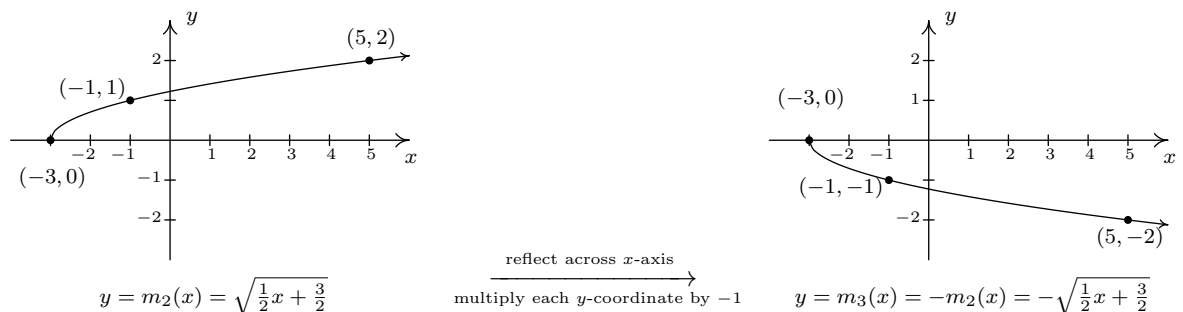

Finally, to handle the vertical shift, Theorem 1.2 gives $m(x) = m_3(x) + 1$, and we see that the range of m is $(-\infty, 1]$.

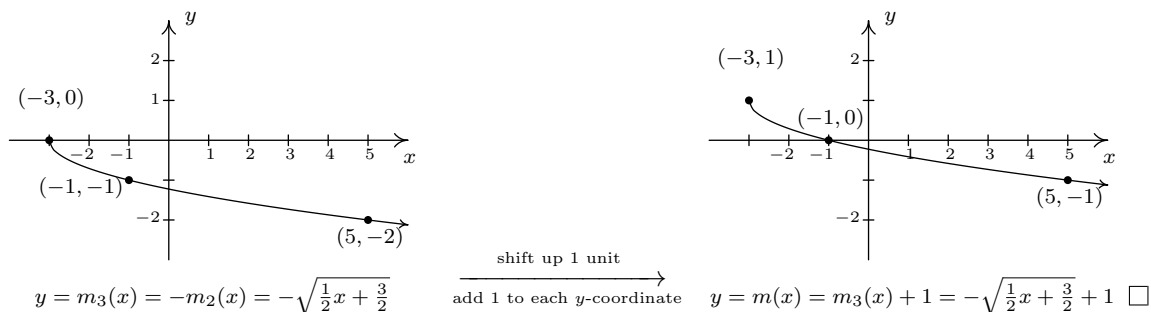

Some comments about Example 1.7.3 are in order. First, recalling the properties of radicals from Intermediate Algebra, we know that the functions g and j are the same, since j and g have the same domains and $j(x) = \sqrt{9x} = \sqrt{9}\sqrt{x} = 3\sqrt{x} = g(x)$. (We invite the reader to verify that all of the points we plotted on the graph of g lie on the graph of j and vice-versa.) Hence, for $f(x) = \sqrt{x}$, a vertical stretch by a factor of 3 and a horizontal shrinking by a factor of 9 result in the same transformation. While this kind of phenomenon is not universal, it happens commonly enough with some of the families of functions studied in College Algebra that it is worthy of note. Secondly, to graph the function m , we applied a series of four transformations. While it would have been easier on the authors to simply inform the reader of which steps to take, we have strived to explain why the order in which the transformations were applied made sense. We generalize the procedure in the theorem below.

Theorem 1.7. Transformations. Suppose f is a function. If $A \neq 0$ and $B \neq 0$, then to graph

$$g(x) = Af(Bx + H) + K$$

1. Subtract H from each of the x -coordinates of the points on the graph of f . This results in a horizontal shift to the left if $H > 0$ or right if $H < 0$.
2. Divide the x -coordinates of the points on the graph obtained in Step 1 by B . This results in a horizontal scaling, but may also include a reflection about the y -axis if $B < 0$.
3. Multiply the y -coordinates of the points on the graph obtained in Step 2 by A . This results in a vertical scaling, but may also include a reflection about the x -axis if $A < 0$.
4. Add K to each of the y -coordinates of the points on the graph obtained in Step 3. This results in a vertical shift up if $K > 0$ or down if $K < 0$.

Theorem 1.7 can be established by generalizing the techniques developed in this section. Suppose (a, b) is on the graph of f . Then $f(a) = b$, and to make good use of this fact, we set $Bx + H = a$ and solve. We first subtract the H (causing the horizontal shift) and then divide by B . If B

is a positive number, this induces only a horizontal scaling by a factor of $\frac{1}{B}$. If $B < 0$, then we have a factor of -1 in play, and dividing by it induces a reflection about the y -axis. So we have $x = \frac{a-H}{B}$ as the input to g which corresponds to the input $x = a$ to f . We now evaluate $g\left(\frac{a-H}{B}\right) = Af\left(B \cdot \frac{a-H}{B} + H\right) + K = Af(a) + K = Ab + K$. We notice that the output from f is first multiplied by A . As with the constant B , if $A > 0$, this induces only a vertical scaling. If $A < 0$, then the -1 induces a reflection across the x -axis. Finally, we add K to the result, which is our vertical shift. A less precise, but more intuitive way to paraphrase Theorem 1.7 is to think of the quantity $Bx + H$ is the ‘inside’ of the function f . What’s happening inside f affects the inputs or x -coordinates of the points on the graph of f . To find the x -coordinates of the corresponding points on g , we undo what has been done to x in the same way we would solve an equation. What’s happening to the output can be thought of as things happening ‘outside’ the function, f . Things happening outside affect the outputs or y -coordinates of the points on the graph of f . Here, we follow the usual order of operations agreement: we first multiply by A then add K to find the corresponding y -coordinates on the graph of g .

Example 1.7.4. Below is the complete graph of $y = f(x)$. Use it to graph $g(x) = \frac{4-3f(1-2x)}{2}$.

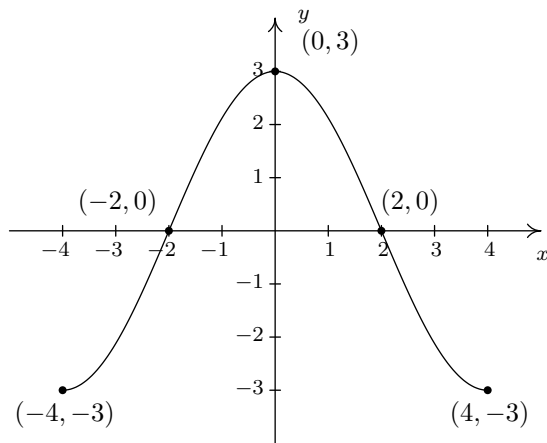

Solution. We use Theorem 1.7 to track the five ‘key points’ $(-4, -3)$, $(-2, 0)$, $(0, 3)$, $(2, 0)$ and $(4, -3)$ indicated on the graph of f to their new locations. We first rewrite $g(x)$ in the form presented in Theorem 1.7, $g(x) = -\frac{3}{2}f(-2x + 1) + 2$. We set $-2x + 1$ equal to the x -coordinates of the key points and solve. For example, solving $-2x + 1 = -4$, we first subtract 1 to get $-2x = -5$ then divide by -2 to get $x = \frac{5}{2}$. Subtracting the 1 is a horizontal shift to the left 1 unit. Dividing by -2 can be thought of as a two step process: dividing by 2 which compresses the graph horizontally by a factor of 2 followed by dividing (multiplying) by -1 which causes a reflection across the y -axis. We summarize the results in the table on the next page.

$(a, f(a))$	a	$-2x + 1 = a$	x
$(-4, -3)$	-4	$-2x + 1 = -4$	$x = \frac{5}{2}$
$(-2, 0)$	-2	$-2x + 1 = -2$	$x = \frac{3}{2}$
$(0, 3)$	0	$-2x + 1 = 0$	$x = \frac{1}{2}$
$(2, 0)$	2	$-2x + 1 = 2$	$x = -\frac{1}{2}$
$(4, -3)$	4	$-2x + 1 = 4$	$x = -\frac{3}{2}$

Next, we take each of the x values and substitute them into $g(x) = -\frac{3}{2}f(-2x + 1) + 2$ to get the corresponding y -values. Substituting $x = \frac{5}{2}$, and using the fact that $f(-4) = -3$, we get

$$g\left(\frac{5}{2}\right) = -\frac{3}{2}f\left(-2\left(\frac{5}{2}\right) + 1\right) + 2 = -\frac{3}{2}f(-4) + 2 = -\frac{3}{2}(-3) + 2 = \frac{9}{2} + 2 = \frac{13}{2}$$

We see that the output from f is first multiplied by $-\frac{3}{2}$. Thinking of this as a two step process, multiplying by $\frac{3}{2}$ then by -1 , we have a vertical stretching by a factor of $\frac{3}{2}$ followed by a reflection across the x -axis. Adding 2 results in a vertical shift up 2 units. Continuing in this manner, we get the table below.

x	$g(x)$	$(x, g(x))$
$\frac{5}{2}$	$\frac{13}{2}$	$(\frac{5}{2}, \frac{13}{2})$
$\frac{3}{2}$	2	$(\frac{3}{2}, 2)$
$\frac{1}{2}$	$-\frac{5}{2}$	$(\frac{1}{2}, -\frac{5}{2})$
$-\frac{1}{2}$	2	$(-\frac{1}{2}, 2)$
$-\frac{3}{2}$	$\frac{13}{2}$	$(-\frac{3}{2}, \frac{13}{2})$

To graph g , we plot each of the points in the table above and connect them in the same order and fashion as the points to which they correspond. Plotting f and g side-by-side gives

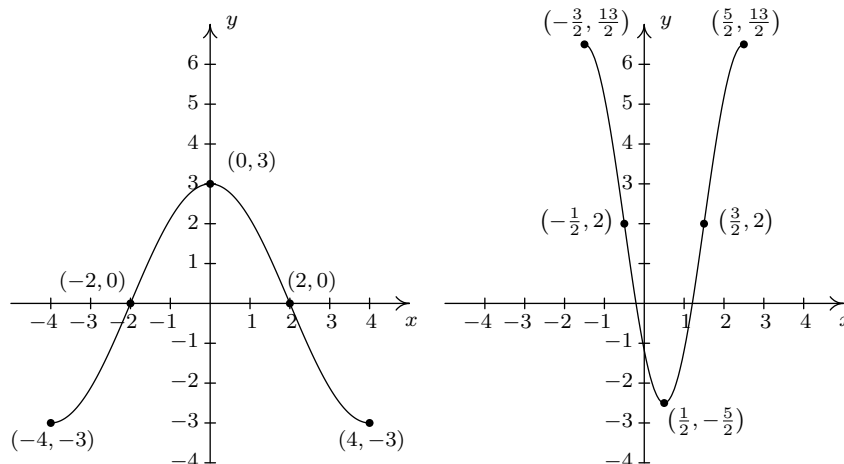

The reader is strongly encouraged¹¹ to graph the series of functions which shows the gradual transformation of the graph of f into the graph of g . We have outlined the sequence of transformations in the above exposition; all that remains is to plot the five intermediate stages. \square

Our last example turns the tables and asks for the formula of a function given a desired sequence of transformations. If nothing else, it is a good review of function notation.

Example 1.7.5. Let $f(x) = x^2$. Find and simplify the formula of the function $g(x)$ whose graph is the result of f undergoing the following sequence of transformations. Check your answer using a graphing calculator.

1. Vertical shift up 2 units
2. Reflection across the x -axis
3. Horizontal shift right 1 unit
4. Horizontal stretching by a factor of 2

Solution. We build up to a formula for $g(x)$ using intermediate functions as we've seen in previous examples. We let g_1 take care of our first step. Theorem 1.2 tells us $g_1(x) = f(x) + 2 = x^2 + 2$. Next, we reflect the graph of g_1 about the x -axis using Theorem 1.4: $g_2(x) = -g_1(x) = -(x^2 + 2) = -x^2 - 2$. We shift the graph to the right 1 unit, according to Theorem 1.3, by setting $g_3(x) = g_2(x - 1) = -(x - 1)^2 - 2 = -x^2 + 2x - 3$. Finally, we induce a horizontal stretch by a factor of 2 using Theorem 1.6 to get $g(x) = g_3(\frac{1}{2}x) = -(\frac{1}{2}x)^2 + 2(\frac{1}{2}x) - 3$ which yields $g(x) = -\frac{1}{4}x^2 + x - 3$. We use the calculator to graph the stages below to confirm our result.

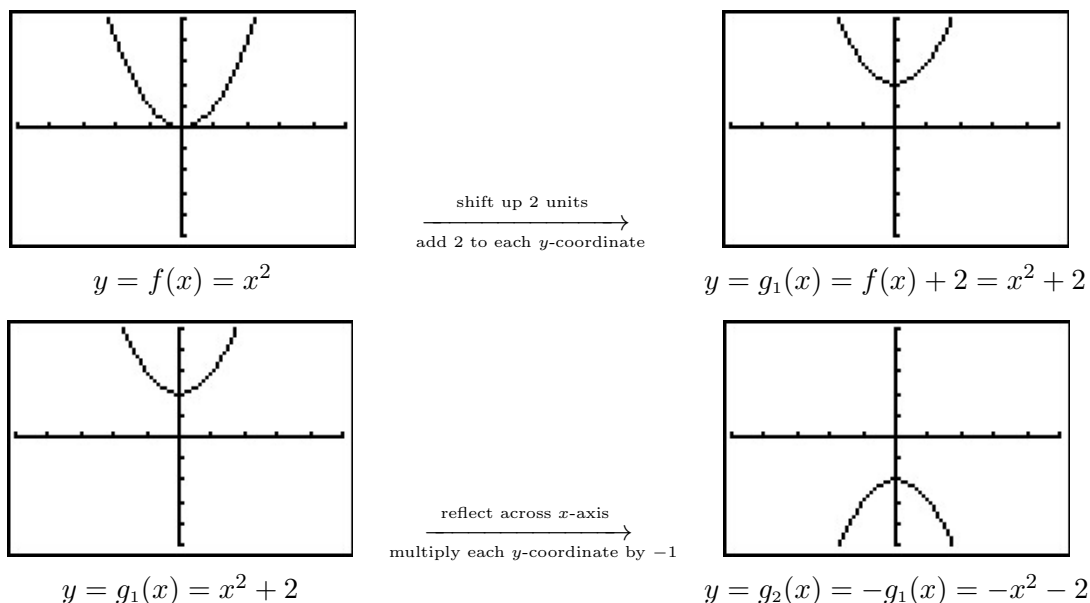

¹¹You really should do this once in your life.

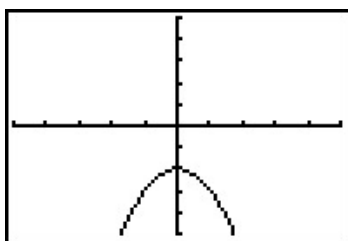

$$y = g_2(x) = -x^2 - 2$$

$\xrightarrow{\text{shift right 1 unit}}$
 $\xrightarrow{\text{add 1 to each } x\text{-coordinate}}$

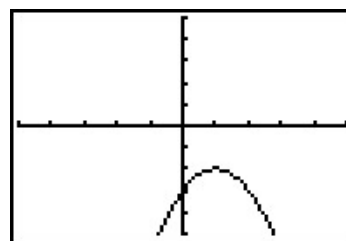

$$y = g_3(x) = g_2(x - 1) = -x^2 + 2x - 3$$

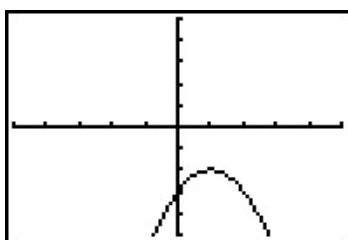

$$y = g_3(x) = -x^2 + 2x - 3$$

$\xrightarrow{\text{horizontal stretch by a factor of 2}}$
 $\xrightarrow{\text{multiply each } x\text{-coordinate by 2}}$

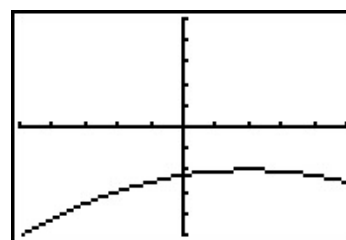

$$y = g(x) = g_3\left(\frac{1}{2}x\right) = -\frac{1}{4}x^2 + x - 3$$

□

We have kept the viewing window the same in all of the graphs above. This had the undesirable consequence of making the last graph look ‘incomplete’ in that we cannot see the original shape of $f(x) = x^2$. Altering the viewing window results in a more complete graph of the transformed function as seen below.

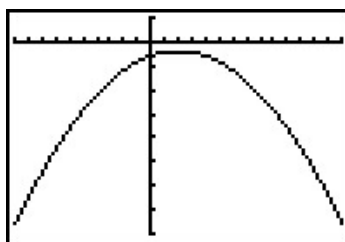

$$y = g(x)$$

This example brings our first chapter to a close. In the chapters which lie ahead, be on the lookout for the concepts developed here to resurface as we study different families of functions.

1.7.1 EXERCISES

Suppose $(2, -3)$ is on the graph of $y = f(x)$. In Exercises 1 - 18, use Theorem 1.7 to find a point on the graph of the given transformed function.

1. $y = f(x) + 3$

2. $y = f(x + 3)$

3. $y = f(x) - 1$

4. $y = f(x - 1)$

5. $y = 3f(x)$

6. $y = f(3x)$

7. $y = -f(x)$

8. $y = f(-x)$

9. $y = f(x - 3) + 1$

10. $y = 2f(x + 1)$

11. $y = 10 - f(x)$

12. $y = 3f(2x) - 1$

13. $y = \frac{1}{2}f(4 - x)$

14. $y = 5f(2x + 1) + 3$

15. $y = 2f(1 - x) - 1$

16. $y = f\left(\frac{7 - 2x}{4}\right)$

17. $y = \frac{f(3x) - 1}{2}$

18. $y = \frac{4 - f(3x - 1)}{7}$

The complete graph of $y = f(x)$ is given below. In Exercises 19 - 27, use it and Theorem 1.7 to graph the given transformed function.

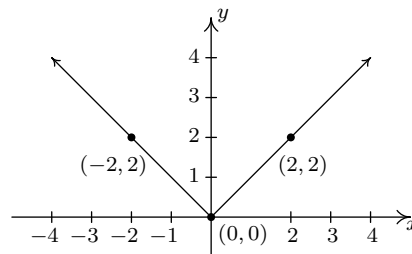

The graph for Ex. 19 - 27

19. $y = f(x) + 1$

20. $y = f(x) - 2$

21. $y = f(x + 1)$

22. $y = f(x - 2)$

23. $y = 2f(x)$

24. $y = f(2x)$

25. $y = 2 - f(x)$

26. $y = f(2 - x)$

27. $y = 2 - f(2 - x)$

28. Some of the answers to Exercises 19 - 27 above should be the same. Which ones match up? What properties of the graph of $y = f(x)$ contribute to the duplication?

The complete graph of $y = f(x)$ is given below. In Exercises 29 - 37, use it and Theorem 1.7 to graph the given transformed function.

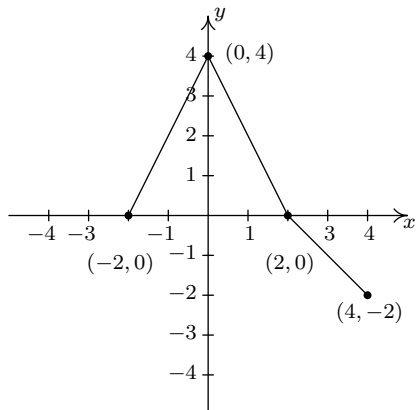

The graph for Ex. 29 - 37

29. $y = f(x) - 1$

30. $y = f(x + 1)$

31. $y = \frac{1}{2}f(x)$

32. $y = f(2x)$

33. $y = -f(x)$

34. $y = f(-x)$

35. $y = f(x + 1) - 1$

36. $y = 1 - f(x)$

37. $y = \frac{1}{2}f(x + 1) - 1$

The complete graph of $y = f(x)$ is given below. In Exercises 38 - 49, use it and Theorem 1.7 to graph the given transformed function.

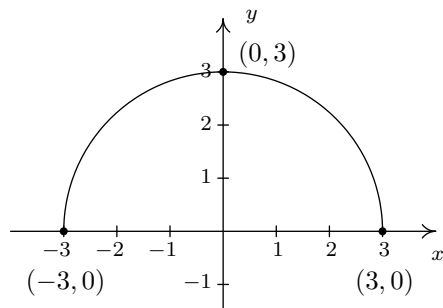

The graph for Ex. 38 - 49

38. $g(x) = f(x) + 3$

39. $h(x) = f(x) - \frac{1}{2}$

40. $j(x) = f\left(x - \frac{2}{3}\right)$

41. $a(x) = f(x + 4)$

42. $b(x) = f(x + 1) - 1$

43. $c(x) = \frac{3}{5}f(x)$

44. $d(x) = -2f(x)$

45. $k(x) = f\left(\frac{2}{3}x\right)$

46. $m(x) = -\frac{1}{4}f(3x)$

47. $n(x) = 4f(x - 3) - 6$

48. $p(x) = 4 + f(1 - 2x)$

49. $q(x) = -\frac{1}{2}f\left(\frac{x+4}{2}\right) - 3$

The complete graph of $y = S(x)$ is given below.

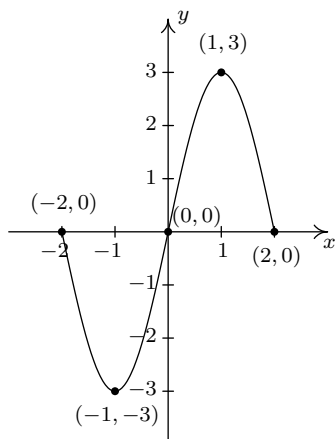

The graph of $y = S(x)$

The purpose of Exercises 50 - 53 is to graph $y = \frac{1}{2}S(-x + 1) + 1$ by graphing each transformation, one step at a time.

50. $y = S_1(x) = S(x + 1)$

51. $y = S_2(x) = S_1(-x) = S(-x + 1)$

52. $y = S_3(x) = \frac{1}{2}S_2(x) = \frac{1}{2}S(-x + 1)$

53. $y = S_4(x) = S_3(x) + 1 = \frac{1}{2}S(-x + 1) + 1$

Let $f(x) = \sqrt{x}$. Find a formula for a function g whose graph is obtained from f from the given sequence of transformations.

54. (1) shift right 2 units; (2) shift down 3 units

55. (1) shift down 3 units; (2) shift right 2 units

56. (1) reflect across the x -axis; (2) shift up 1 unit

57. (1) shift up 1 unit; (2) reflect across the x -axis

58. (1) shift left 1 unit; (2) reflect across the y -axis; (3) shift up 2 units

59. (1) reflect across the y -axis; (2) shift left 1 unit; (3) shift up 2 units

60. (1) shift left 3 units; (2) vertical stretch by a factor of 2; (3) shift down 4 units

61. (1) shift left 3 units; (2) shift down 4 units; (3) vertical stretch by a factor of 2

62. (1) shift right 3 units; (2) horizontal shrink by a factor of 2; (3) shift up 1 unit

63. (1) horizontal shrink by a factor of 2; (2) shift right 3 units; (3) shift up 1 unit

64. The graph of $y = f(x) = \sqrt[3]{x}$ is given below on the left and the graph of $y = g(x)$ is given on the right. Find a formula for g based on transformations of the graph of f . Check your answer by confirming that the points shown on the graph of g satisfy the equation $y = g(x)$.

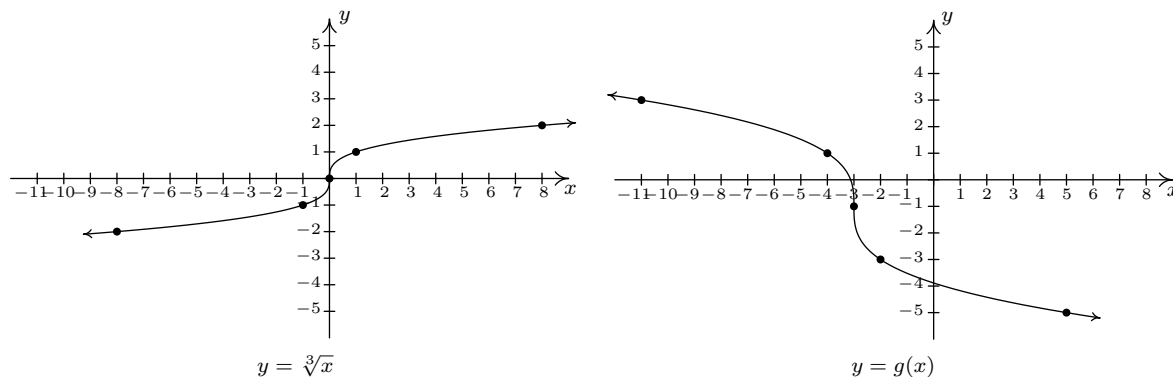

65. For many common functions, the properties of Algebra make a horizontal scaling the same as a vertical scaling by (possibly) a different factor. For example, we stated earlier that $\sqrt{9x} = 3\sqrt{x}$. With the help of your classmates, find the equivalent vertical scaling produced by the horizontal scalings $y = (2x)^3$, $y = |5x|$, $y = \sqrt[3]{27x}$ and $y = \left(\frac{1}{2}x\right)^2$. What about $y = (-2x)^3$, $y = |-5x|$, $y = \sqrt[3]{-27x}$ and $y = \left(-\frac{1}{2}x\right)^2$?
66. We mentioned earlier in the section that, in general, the order in which transformations are applied matters, yet in our first example with two transformations the order did not matter. (You could perform the shift to the left followed by the shift down or you could shift down and then left to achieve the same result.) With the help of your classmates, determine the situations in which order does matter and those in which it does not.
67. What happens if you reflect an even function across the y -axis?
68. What happens if you reflect an odd function across the y -axis?
69. What happens if you reflect an even function across the x -axis?
70. What happens if you reflect an odd function across the x -axis?
71. How would you describe symmetry about the origin in terms of reflections?
72. As we saw in Example 1.7.5, the viewing window on the graphing calculator affects how we see the transformations done to a graph. Using two different calculators, find viewing windows so that $f(x) = x^2$ on the one calculator looks like $g(x) = 3x^2$ on the other.

1.7.2 ANSWERS

1. $(2, 0)$

2. $(-1, -3)$

3. $(2, -4)$

4. $(3, -3)$

5. $(2, -9)$

6. $(\frac{2}{3}, -3)$

7. $(2, 3)$

8. $(-2, -3)$

9. $(5, -2)$

10. $(1, -6)$

11. $(2, 13)$

12. $y = (1, -10)$

13. $(2, -\frac{3}{2})$

14. $(\frac{1}{2}, -12)$

15. $(-1, -7)$

16. $(-\frac{1}{2}, -3)$

17. $(\frac{2}{3}, -2)$

18. $(1, 1)$

19. $y = f(x) + 1$

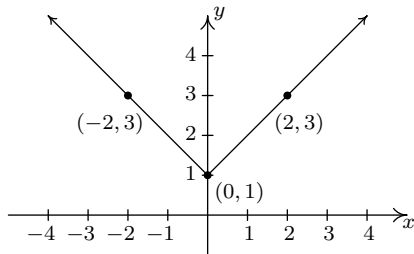

20. $y = f(x) - 2$

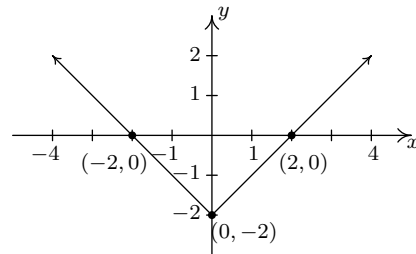

21. $y = f(x + 1)$

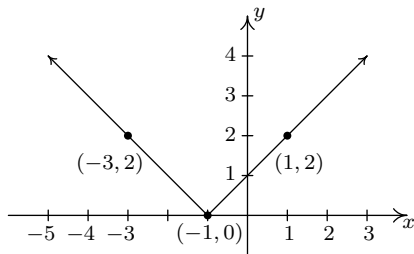

22. $y = f(x - 2)$

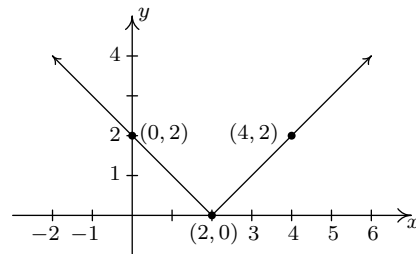

23. $y = 2f(x)$

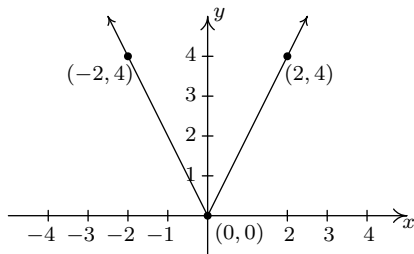

24. $y = f(2x)$

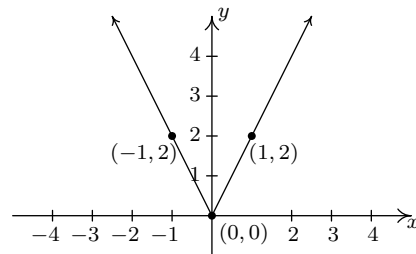

25. $y = 2 - f(x)$

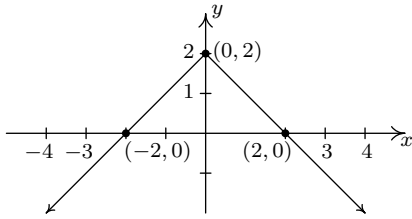

26. $y = f(2 - x)$

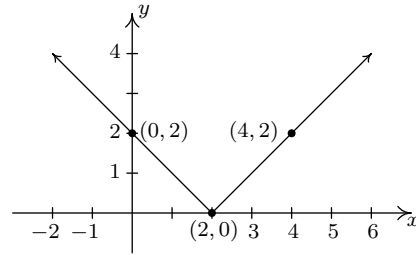

27. $y = 2 - f(2 - x)$

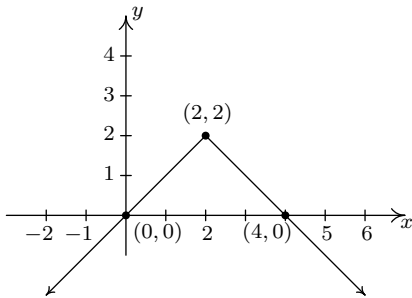

29. $y = f(x) - 1$

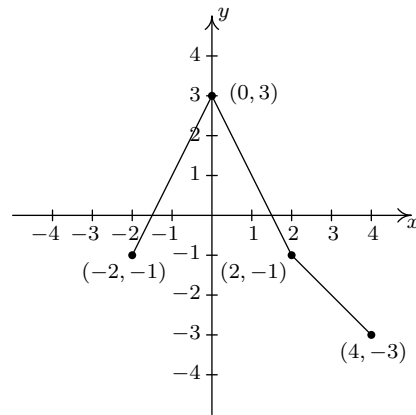

30. $y = f(x + 1)$

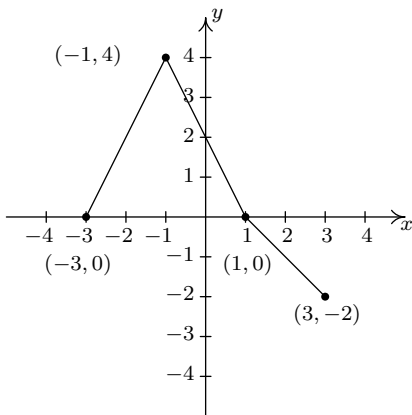

31. $y = \frac{1}{2}f(x)$

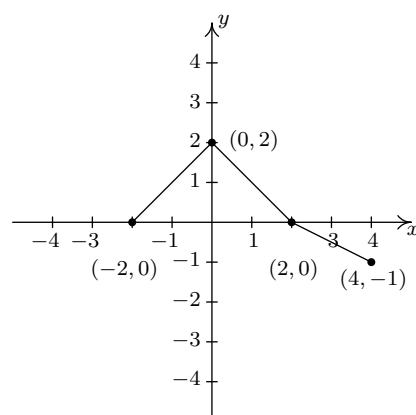

32. $y = f(2x)$

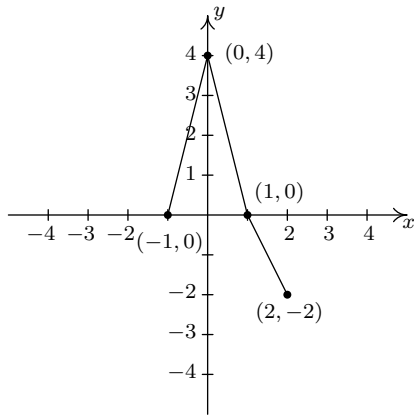

33. $y = -f(x)$

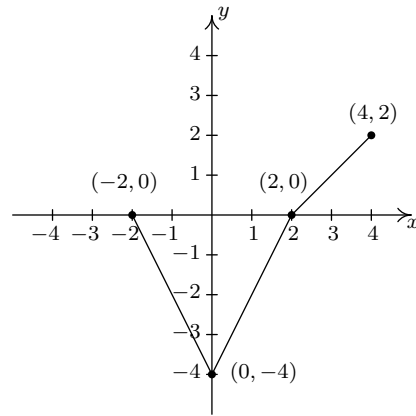

34. $y = f(-x)$

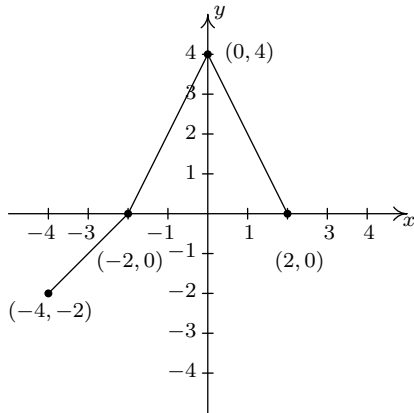

35. $y = f(x + 1) - 1$

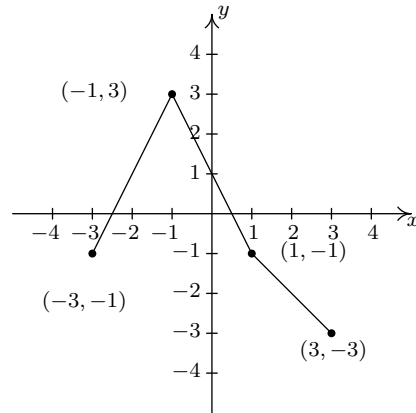

36. $y = 1 - f(x)$

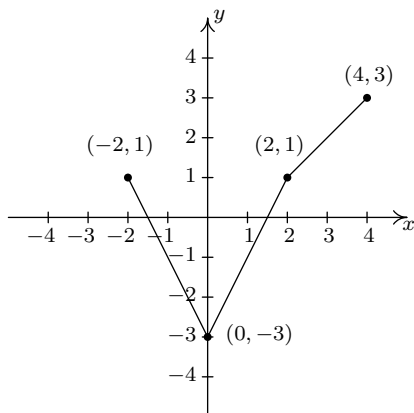

37. $y = \frac{1}{2}f(x + 1) - 1$

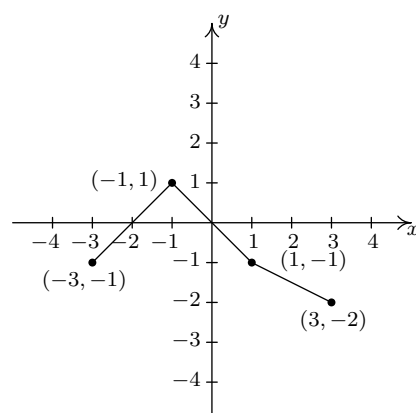

38. $g(x) = f(x) + 3$

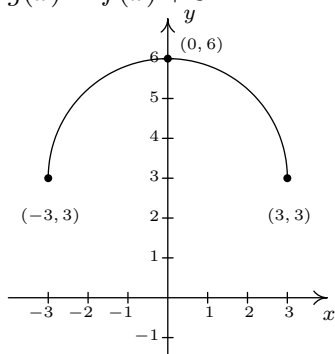

39. $h(x) = f(x) - \frac{1}{2}$

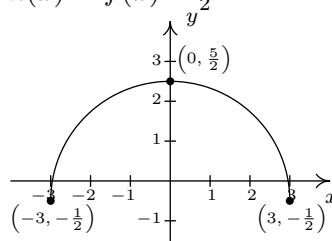

40. $j(x) = f(x - \frac{2}{3})$

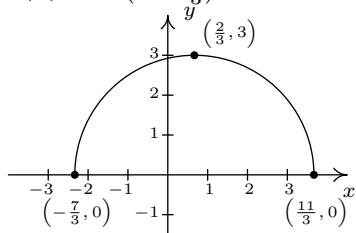

41. $a(x) = f(x + 4)$

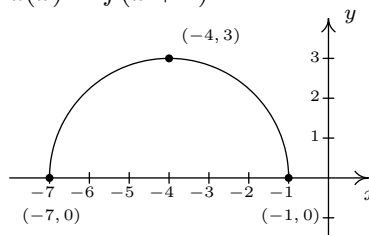

42. $b(x) = f(x + 1) - 1$

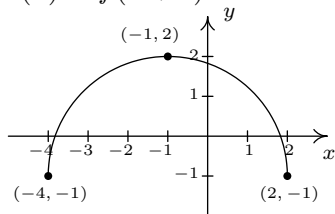

43. $c(x) = \frac{3}{5}f(x)$

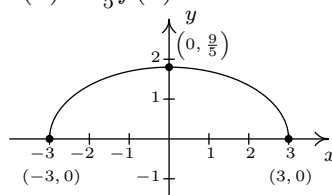

44. $d(x) = -2f(x)$

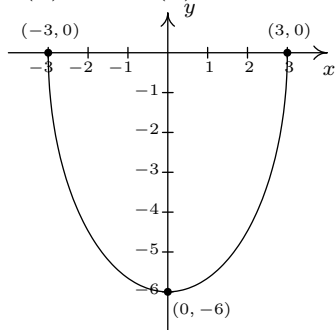

45. $k(x) = f(\frac{2}{3}x)$

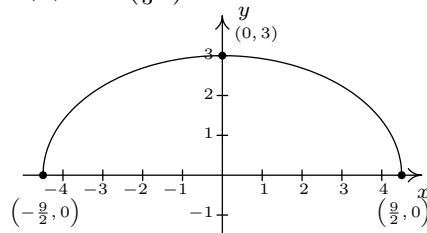

46. $m(x) = -\frac{1}{4}f(3x)$

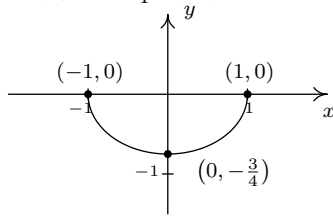

47. $n(x) = 4f(x - 3) - 6$

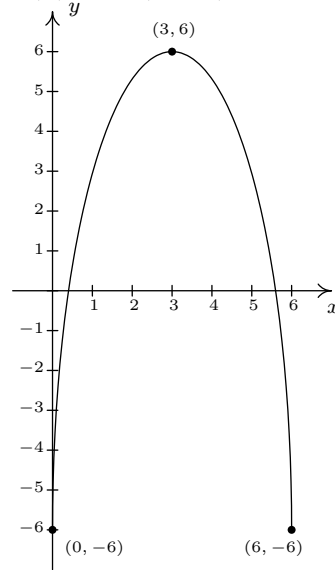

48. $p(x) = 4 + f(1 - 2x) = f(-2x + 1) + 4$

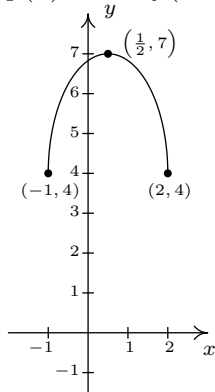

49. $q(x) = -\frac{1}{2}f\left(\frac{x+4}{2}\right) - 3 = -\frac{1}{2}f\left(\frac{1}{2}x + 2\right) - 3$

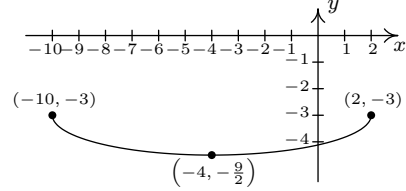

50. $y = S_1(x) = S(x + 1)$

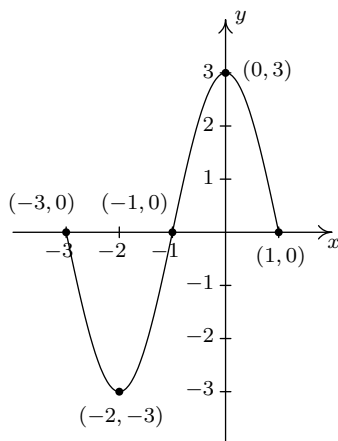

51. $y = S_2(x) = S_1(-x) = S(-x + 1)$

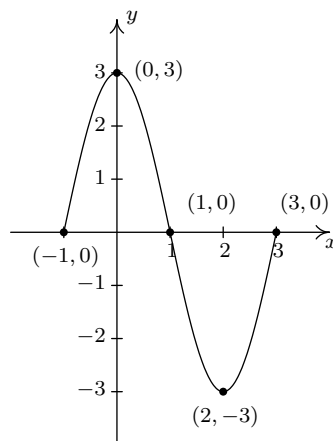

52. $y = S_3(x) = \frac{1}{2}S_2(x) = \frac{1}{2}S(-x + 1)$

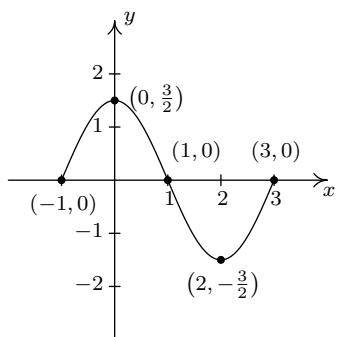

53. $y = S_4(x) = S_3(x) + 1 = \frac{1}{2}S(-x + 1) + 1$

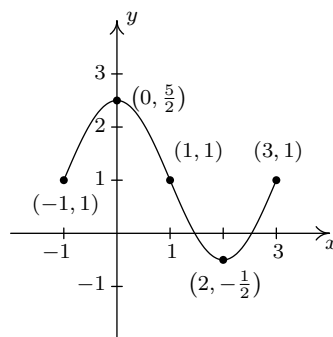

54. $g(x) = \sqrt{x-2} - 3$

55. $g(x) = \sqrt{x-2} - 3$

56. $g(x) = -\sqrt{x} + 1$

57. $g(x) = -(\sqrt{x} + 1) = -\sqrt{x} - 1$

58. $g(x) = \sqrt{-x+1} + 2$

59. $g(x) = \sqrt{-(x+1)} + 2 = \sqrt{-x-1} + 2$

60. $g(x) = 2\sqrt{x+3} - 4$

61. $g(x) = 2(\sqrt{x+3} - 4) = 2\sqrt{x+3} - 8$

62. $g(x) = \sqrt{2x-3} + 1$

63. $g(x) = \sqrt{2(x-3)} + 1 = \sqrt{2x-6} + 1$

64. $g(x) = -2\sqrt[3]{x+3} - 1$ or $g(x) = 2\sqrt[3]{-x-3} - 1$

CHAPTER 2

LINEAR AND QUADRATIC FUNCTIONS

2.1 LINEAR FUNCTIONS

We now begin the study of families of functions. Our first family, linear functions, are old friends as we shall soon see. Recall from Geometry that two distinct points in the plane determine a unique line containing those points, as indicated below.

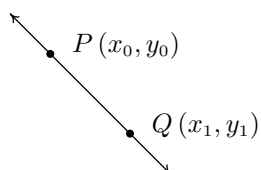

To give a sense of the ‘steepness’ of the line, we recall that we can compute the **slope** of the line using the formula below.

Equation 2.1. The **slope** m of the line containing the points $P(x_0, y_0)$ and $Q(x_1, y_1)$ is:

$$m = \frac{y_1 - y_0}{x_1 - x_0},$$

provided $x_1 \neq x_0$.

A couple of notes about Equation 2.1 are in order. First, don’t ask why we use the letter ‘ m ’ to represent slope. There are many explanations out there, but apparently no one really knows for sure.¹ Secondly, the stipulation $x_1 \neq x_0$ ensures that we aren’t trying to divide by zero. The reader is invited to pause to think about what is happening geometrically; the anxious reader can skip along to the next example.

Example 2.1.1. Find the slope of the line containing the following pairs of points, if it exists. Plot each pair of points and the line containing them.

¹See www.mathforum.org or www.mathworld.wolfram.com for discussions on this topic.

1. $P(0, 0), Q(2, 4)$

2. $P(-1, 2), Q(3, 4)$

3. $P(-2, 3), Q(2, -3)$

4. $P(-3, 2), Q(4, 2)$

5. $P(2, 3), Q(2, -1)$

6. $P(2, 3), Q(2.1, -1)$

Solution. In each of these examples, we apply the slope formula, Equation 2.1.

1.
$$m = \frac{4 - 0}{2 - 0} = \frac{4}{2} = 2$$

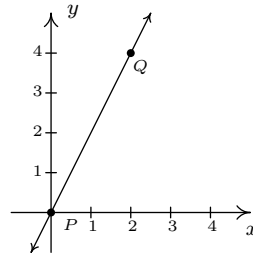

2.
$$m = \frac{4 - 2}{3 - (-1)} = \frac{2}{4} = \frac{1}{2}$$

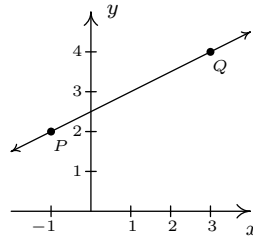

3.
$$m = \frac{-3 - 3}{2 - (-2)} = \frac{-6}{4} = -\frac{3}{2}$$

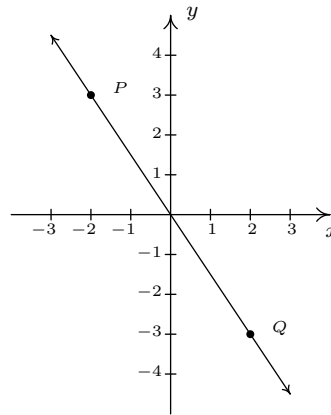

4.
$$m = \frac{2 - 2}{4 - (-3)} = \frac{0}{7} = 0$$

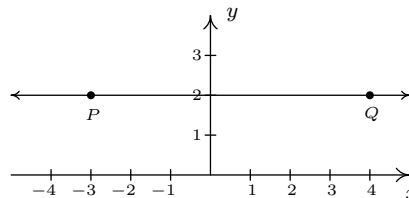

$$5. \quad m = \frac{-1 - 3}{2 - 2} = \frac{-4}{0}, \text{ which is undefined}$$

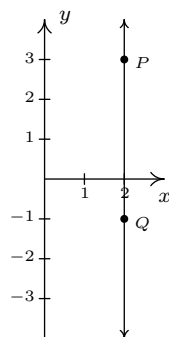

$$6. \quad m = \frac{-1 - 3}{2.1 - 2} = \frac{-4}{0.1} = -40$$

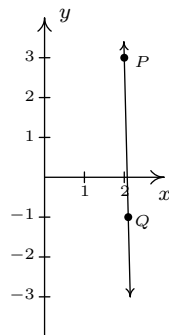

□

A few comments about Example 2.1.1 are in order. First, for reasons which will be made clear soon, if the slope is positive then the resulting line is said to be increasing. If it is negative, we say the line is decreasing. A slope of 0 results in a horizontal line which we say is constant, and an undefined slope results in a vertical line.² Second, the larger the slope is in absolute value, the steeper the line. You may recall from Intermediate Algebra that slope can be described as the ratio ‘ $\frac{\text{rise}}{\text{run}}$ ’. For example, in the second part of Example 2.1.1, we found the slope to be $\frac{1}{2}$. We can interpret this as a rise of 1 unit upward for every 2 units to the right we travel along the line, as shown below.

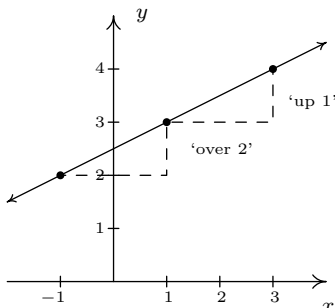

²Some authors use the unfortunate moniker ‘no slope’ when a slope is undefined. It’s easy to confuse the notions of ‘no slope’ with ‘slope of 0’. For this reason, we will describe slopes of vertical lines as ‘undefined’.

Using more formal notation, given points (x_0, y_0) and (x_1, y_1) , we use the Greek letter delta ‘ Δ ’ to write $\Delta y = y_1 - y_0$ and $\Delta x = x_1 - x_0$. In most scientific circles, the symbol Δ means ‘change in’.

Hence, we may write

$$m = \frac{\Delta y}{\Delta x},$$

which describes the slope as the **rate of change** of y with respect to x . Rates of change abound in the ‘real world’, as the next example illustrates.

Example 2.1.2. Suppose that two separate temperature readings were taken at the ranger station on the top of Mt. Sasquatch: at 6 AM the temperature was 24°F and at 10 AM it was 32°F .

1. Find the slope of the line containing the points $(6, 24)$ and $(10, 32)$.
2. Interpret your answer to the first part in terms of temperature and time.
3. Predict the temperature at noon.

Solution.

1. For the slope, we have $m = \frac{32-24}{10-6} = \frac{8}{4} = 2$.
2. Since the values in the numerator correspond to the temperatures in $^\circ\text{F}$, and the values in the denominator correspond to time in hours, we can interpret the slope as $2 = \frac{2}{1} = \frac{2^\circ\text{F}}{1\text{ hour}}$, or 2°F per hour. Since the slope is positive, we know this corresponds to an increasing line. Hence, the temperature is increasing at a rate of 2°F per hour.
3. Noon is two hours after 10 AM. Assuming a temperature increase of 2°F per hour, in two hours the temperature should rise 4°F . Since the temperature at 10 AM is 32°F , we would expect the temperature at noon to be $32 + 4 = 36^\circ\text{F}$. \square

Now it may well happen that in the previous scenario, at noon the temperature is only 33°F . This doesn’t mean our calculations are incorrect, rather, it means that the temperature change throughout the day isn’t a constant 2°F per hour. As discussed in Section 1.4.1, mathematical models are just that: models. The predictions we get out of the models may be mathematically accurate, but may not resemble what happens in the real world.

In Section 1.2, we discussed the equations of vertical and horizontal lines. Using the concept of slope, we can develop equations for the other varieties of lines. Suppose a line has a slope of m and contains the point (x_0, y_0) . Suppose (x, y) is another point on the line, as indicated below.

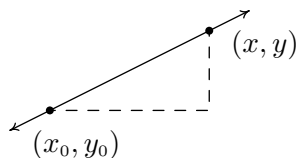

Equation 2.1 yields

$$\begin{aligned} m &= \frac{y - y_0}{x - x_0} \\ m(x - x_0) &= y - y_0 \\ y - y_0 &= m(x - x_0) \end{aligned}$$

We have just derived the **point-slope form** of a line.³

Equation 2.2. The **point-slope form** of the line with slope m containing the point (x_0, y_0) is the equation $y - y_0 = m(x - x_0)$.

Example 2.1.3. Write the equation of the line containing the points $(-1, 3)$ and $(2, 1)$.

Solution. In order to use Equation 2.2 we need to find the slope of the line in question so we use Equation 2.1 to get $m = \frac{\Delta y}{\Delta x} = \frac{1-3}{2-(-1)} = -\frac{2}{3}$. We are spoiled for choice for a point (x_0, y_0) . We'll use $(-1, 3)$ and leave it to the reader to check that using $(2, 1)$ results in the same equation. Substituting into the point-slope form of the line, we get

$$\begin{aligned} y - y_0 &= m(x - x_0) \\ y - 3 &= -\frac{2}{3}(x - (-1)) \\ y - 3 &= -\frac{2}{3}(x + 1) \\ y - 3 &= -\frac{2}{3}x - \frac{2}{3} \\ y &= -\frac{2}{3}x + \frac{7}{3}. \end{aligned}$$

We can check our answer by showing that both $(-1, 3)$ and $(2, 1)$ are on the graph of $y = -\frac{2}{3}x + \frac{7}{3}$ algebraically, as we did in Section 1.2.1. \square

In simplifying the equation of the line in the previous example, we produced another form of a line, the **slope-intercept form**. This is the familiar $y = mx + b$ form you have probably seen in Intermediate Algebra. The 'intercept' in 'slope-intercept' comes from the fact that if we set $x = 0$, we get $y = b$. In other words, the y -intercept of the line $y = mx + b$ is $(0, b)$.

Equation 2.3. The **slope-intercept form** of the line with slope m and y -intercept $(0, b)$ is the equation $y = mx + b$.

Note that if we have slope $m = 0$, we get the equation $y = b$ which matches our formula for a horizontal line given in Section 1.2. The formula given in Equation 2.3 can be used to describe all lines except vertical lines. All lines except vertical lines are functions (Why is this?) so we have finally reached a good point to introduce **linear functions**.

³We can also understand this equation in terms of applying transformations to the function $I(x) = x$. See the Exercises.

Definition 2.1. A **linear function** is a function of the form

$$f(x) = mx + b,$$

where m and b are real numbers with $m \neq 0$. The domain of a linear function is $(-\infty, \infty)$.

For the case $m = 0$, we get $f(x) = b$. These are given their own classification.

Definition 2.2. A **constant function** is a function of the form

$$f(x) = b,$$

where b is real number. The domain of a constant function is $(-\infty, \infty)$.

Recall that to graph a function, f , we graph the equation $y = f(x)$. Hence, the graph of a linear function is a line with slope m and y -intercept $(0, b)$; the graph of a constant function is a horizontal line (a line with slope $m = 0$) and a y -intercept of $(0, b)$. Now think back to Section 1.6.1, specifically Definition 1.10 concerning increasing, decreasing and constant functions. A line with positive slope was called an increasing line because a linear function with $m > 0$ is an increasing function. Similarly, a line with a negative slope was called a decreasing line because a linear function with $m < 0$ is a decreasing function. And horizontal lines were called constant because, well, we hope you've already made the connection.

Example 2.1.4. Graph the following functions. Identify the slope and y -intercept.

1. $f(x) = 3$

3. $f(x) = \frac{3 - 2x}{4}$

2. $f(x) = 3x - 1$

4. $f(x) = \frac{x^2 - 4}{x - 2}$

Solution.

1. To graph $f(x) = 3$, we graph $y = 3$. This is a horizontal line ($m = 0$) through $(0, 3)$.
2. The graph of $f(x) = 3x - 1$ is the graph of the line $y = 3x - 1$. Comparison of this equation with Equation 2.3 yields $m = 3$ and $b = -1$. Hence, our slope is 3 and our y -intercept is $(0, -1)$. To get another point on the line, we can plot $(1, f(1)) = (1, 2)$.

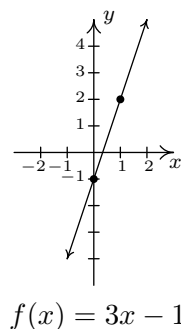
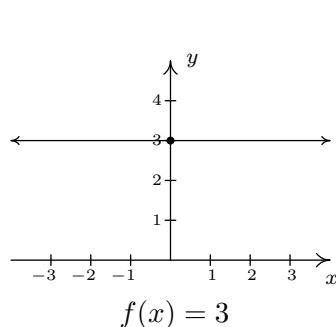

3. At first glance, the function $f(x) = \frac{3-2x}{4}$ does not fit the form in Definition 2.1 but after some rearranging we get $f(x) = \frac{3-2x}{4} = \frac{3}{4} - \frac{2x}{4} = -\frac{1}{2}x + \frac{3}{4}$. We identify $m = -\frac{1}{2}$ and $b = \frac{3}{4}$. Hence, our graph is a line with a slope of $-\frac{1}{2}$ and a y -intercept of $(0, \frac{3}{4})$. Plotting an additional point, we can choose $(1, f(1))$ to get $(1, \frac{1}{4})$.
4. If we simplify the expression for f , we get

$$f(x) = \frac{x^2 - 4}{x - 2} = \frac{\cancel{(x-2)}(x+2)}{\cancel{(x-2)}} = x + 2.$$

If we were to state $f(x) = x + 2$, we would be committing a sin of omission. Remember, to find the domain of a function, we do so **before** we simplify! In this case, f has big problems when $x = 2$, and as such, the domain of f is $(-\infty, 2) \cup (2, \infty)$. To indicate this, we write $f(x) = x + 2, x \neq 2$. So, except at $x = 2$, we graph the line $y = x + 2$. The slope $m = 1$ and the y -intercept is $(0, 2)$. A second point on the graph is $(1, f(1)) = (1, 3)$. Since our function f is not defined at $x = 2$, we put an open circle at the point that would be on the line $y = x + 2$ when $x = 2$, namely $(2, 4)$.

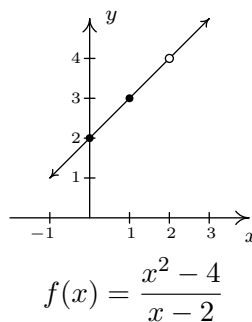
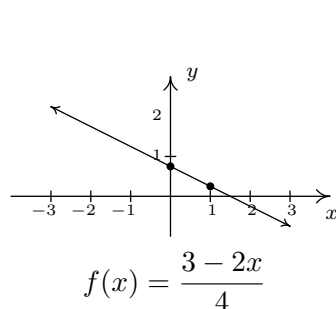

□

The last two functions in the previous example showcase some of the difficulty in defining a linear function using the phrase ‘of the form’ as in Definition 2.1, since some algebraic manipulations may be needed to rewrite a given function to match ‘the form’. Keep in mind that the domains of linear and constant functions are all real numbers $(-\infty, \infty)$, so while $f(x) = \frac{x^2-4}{x-2}$ simplified to a formula $f(x) = x + 2$, f is not considered a linear function since its domain excludes $x = 2$. However, we would consider

$$f(x) = \frac{2x^2 + 2}{x^2 + 1}$$

to be a constant function since its domain is all real numbers (Can you tell us why?) and

$$f(x) = \frac{2x^2 + 2}{x^2 + 1} = \frac{2(\cancel{x^2 + 1})}{(\cancel{x^2 + 1})} = 2$$

The following example uses linear functions to model some basic economic relationships.

Example 2.1.5. The cost C , in dollars, to produce x PortaBoy⁴ game systems for a local retailer is given by $C(x) = 80x + 150$ for $x \geq 0$.

1. Find and interpret $C(10)$.
2. How many PortaBoys can be produced for \$15,000?
3. Explain the significance of the restriction on the domain, $x \geq 0$.
4. Find and interpret $C(0)$.
5. Find and interpret the slope of the graph of $y = C(x)$.

Solution.

1. To find $C(10)$, we replace every occurrence of x with 10 in the formula for $C(x)$ to get $C(10) = 80(10) + 150 = 950$. Since x represents the number of PortaBoys produced, and $C(x)$ represents the cost, in dollars, $C(10) = 950$ means it costs \$950 to produce 10 PortaBoys for the local retailer.
2. To find how many PortaBoys can be produced for \$15,000, we solve $C(x) = 15000$, or $80x + 150 = 15000$. Solving, we get $x = \frac{14850}{80} = 185.625$. Since we can only produce a whole number amount of PortaBoys, we can produce 185 PortaBoys for \$15,000.
3. The restriction $x \geq 0$ is the applied domain, as discussed in Section 1.4.1. In this context, x represents the number of PortaBoys produced. It makes no sense to produce a negative quantity of game systems.⁵

⁴The similarity of this name to [PortaJohn](#) is deliberate.

⁵Actually, it makes no sense to produce a fractional part of a game system, either, as we saw in the previous part of this example. This absurdity, however, seems quite forgivable in some textbooks but not to us.

4. We find $C(0) = 80(0) + 150 = 150$. This means it costs \$150 to produce 0 PortaBoys. As mentioned on page 216, this is the fixed, or start-up cost of this venture.
5. If we were to graph $y = C(x)$, we would be graphing the portion of the line $y = 80x + 150$ for $x \geq 0$. We recognize the slope, $m = 80$. Like any slope, we can interpret this as a rate of change. Here, $C(x)$ is the cost in dollars, while x measures the number of PortaBoys so

$$m = \frac{\Delta y}{\Delta x} = \frac{\Delta C}{\Delta x} = 80 = \frac{80}{1} = \frac{\$80}{1 \text{ PortaBoy}}.$$

In other words, the cost is increasing at a rate of \$80 per PortaBoy produced. This is often called the **variable cost** for this venture. \square

The next example asks us to find a linear function to model a related economic problem.

Example 2.1.6. The local retailer in Example 2.1.5 has determined that the number x of PortaBoy game systems sold in a week is related to the price p in dollars of each system. When the price was \$220, 20 game systems were sold in a week. When the systems went on sale the following week, 40 systems were sold at \$190 a piece.

1. Find a linear function which fits this data. Use the weekly sales x as the independent variable and the price p as the dependent variable.
2. Find a suitable applied domain.
3. Interpret the slope.
4. If the retailer wants to sell 150 PortaBoys next week, what should the price be?
5. What would the weekly sales be if the price were set at \$150 per system?

Solution.

1. We recall from Section 1.4 the meaning of ‘independent’ and ‘dependent’ variable. Since x is to be the independent variable, and p the dependent variable, we treat x as the input variable and p as the output variable. Hence, we are looking for a function of the form $p(x) = mx + b$. To determine m and b , we use the fact that 20 PortaBoys were sold during the week when the price was 220 dollars and 40 units were sold when the price was 190 dollars. Using function notation, these two facts can be translated as $p(20) = 220$ and $p(40) = 190$. Since m represents the rate of change of p with respect to x , we have

$$m = \frac{\Delta p}{\Delta x} = \frac{190 - 220}{40 - 20} = \frac{-30}{20} = -1.5.$$

We now have determined $p(x) = -1.5x + b$. To determine b , we can use our given data again. Using $p(20) = 220$, we substitute $x = 20$ into $p(x) = -1.5x + b$ and set the result equal to 220: $-1.5(20) + b = 220$. Solving, we get $b = 250$. Hence, we get $p(x) = -1.5x + 250$. We can check our formula by computing $p(20)$ and $p(40)$ to see if we get 220 and 190, respectively. You may recall from page 216 that the function $p(x)$ is called the price-demand (or simply demand) function for this venture.

2. To determine the applied domain, we look at the physical constraints of the problem. Certainly, we can't sell a negative number of PortaBoys, so $x \geq 0$. However, we also note that the slope of this linear function is negative, and as such, the price is decreasing as more units are sold. Thus another constraint on the price is $p(x) \geq 0$. Solving $-1.5x + 250 \geq 0$ results in $-1.5x \geq -250$ or $x \leq \frac{500}{3} = 166.\bar{6}$. Since x represents the number of PortaBoys sold in a week, we round down to 166. As a result, a reasonable applied domain for p is $[0, 166]$.
3. The slope $m = -1.5$, once again, represents the rate of change of the price of a system with respect to weekly sales of PortaBoys. Since the slope is negative, we have that the price is decreasing at a rate of \$1.50 per PortaBoy sold. (Said differently, you can sell one more PortaBoy for every \$1.50 drop in price.)
4. To determine the price which will move 150 PortaBoys, we find $p(150) = -1.5(150) + 250 = 25$. That is, the price would have to be \$25.
5. If the price of a PortaBoy were set at \$150, we have $p(x) = 150$, or, $-1.5x + 250 = 150$. Solving, we get $-1.5x = -100$ or $x = 66.\bar{6}$. This means you would be able to sell 66 PortaBoys a week if the price were \$150 per system. \square

Not all real-world phenomena can be modeled using linear functions. Nevertheless, it is possible to use the concept of slope to help analyze non-linear functions using the following.

Definition 2.3. Let f be a function defined on the interval $[a, b]$. The **average rate of change** of f over $[a, b]$ is defined as:

$$\frac{\Delta f}{\Delta x} = \frac{f(b) - f(a)}{b - a}$$

Geometrically, if we have the graph of $y = f(x)$, the average rate of change over $[a, b]$ is the slope of the line which connects $(a, f(a))$ and $(b, f(b))$. This is called the **secant line** through these points. For that reason, some textbooks use the notation m_{sec} for the average rate of change of a function. Note that for a linear function $m = m_{\text{sec}}$, or in other words, its rate of change over an interval is the same as its average rate of change.

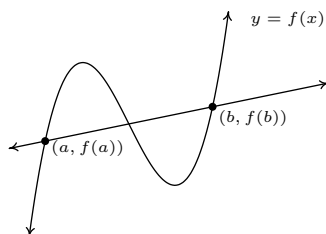

The graph of $y = f(x)$ and its secant line through $(a, f(a))$ and $(b, f(b))$

The interested reader may question the adjective 'average' in the phrase 'average rate of change'. In the figure above, we can see that the function changes wildly on $[a, b]$, yet the slope of the secant line only captures a snapshot of the action at a and b . This situation is entirely analogous to the

average speed on a trip. Suppose it takes you 2 hours to travel 100 miles. Your average speed is $\frac{100 \text{ miles}}{2 \text{ hours}} = 50$ miles per hour. However, it is entirely possible that at the start of your journey, you traveled 25 miles per hour, then sped up to 65 miles per hour, and so forth. The average rate of change is akin to your average speed on the trip. Your speedometer measures your speed at any one instant along the trip, your **instantaneous rate of change**, and this is one of the central themes of Calculus.⁶

When interpreting rates of change, we interpret them the same way we did slopes. In the context of functions, it may be helpful to think of the average rate of change as:

$$\frac{\text{change in outputs}}{\text{change in inputs}}$$

Example 2.1.7. Recall from page 216, the revenue from selling x units at a price p per unit is given by the formula $R = xp$. Suppose we are in the scenario of Examples 2.1.5 and 2.1.6.

1. Find and simplify an expression for the weekly revenue $R(x)$ as a function of weekly sales x .
2. Find and interpret the average rate of change of $R(x)$ over the interval $[0, 50]$.
3. Find and interpret the average rate of change of $R(x)$ as x changes from 50 to 100 and compare that to your result in part 2.
4. Find and interpret the average rate of change of weekly revenue as weekly sales increase from 100 PortaBoys to 150 PortaBoys.

Solution.

1. Since $R = xp$, we substitute $p(x) = -1.5x + 250$ from Example 2.1.6 to get $R(x) = x(-1.5x + 250) = -1.5x^2 + 250x$. Since we determined the price-demand function $p(x)$ is restricted to $0 \leq x \leq 166$, $R(x)$ is restricted to these values of x as well.
2. Using Definition 2.3, we get that the average rate of change is

$$\frac{\Delta R}{\Delta x} = \frac{R(50) - R(0)}{50 - 0} = \frac{8750 - 0}{50 - 0} = 175.$$

Interpreting this slope as we have in similar situations, we conclude that for every additional PortaBoy sold during a given week, the weekly revenue increases \$175.

3. The wording of this part is slightly different than that in Definition 2.3, but its meaning is to find the average rate of change of R over the interval $[50, 100]$. To find this rate of change, we compute

$$\frac{\Delta R}{\Delta x} = \frac{R(100) - R(50)}{100 - 50} = \frac{10000 - 8750}{50} = 25.$$

⁶Here we go again...

In other words, for each additional PortaBoy sold, the revenue increases by \$25. Note that while the revenue is still increasing by selling more game systems, we aren't getting as much of an increase as we did in part 2 of this example. (Can you think of why this would happen?)

4. Translating the English to the mathematics, we are being asked to find the average rate of change of R over the interval $[100, 150]$. We find

$$\frac{\Delta R}{\Delta x} = \frac{R(150) - R(100)}{150 - 100} = \frac{3750 - 10000}{50} = -125.$$

This means that we are losing \$125 dollars of weekly revenue for each additional PortaBoy sold. (Can you think why this is possible?) \square

We close this section with a new look at difference quotients which were first introduced in Section 1.4. If we wish to compute the average rate of change of a function f over the interval $[x, x + h]$, then we would have

$$\frac{\Delta f}{\Delta x} = \frac{f(x + h) - f(x)}{(x + h) - x} = \frac{f(x + h) - f(x)}{h}$$

As we have indicated, the rate of change of a function (average or otherwise) is of great importance in Calculus.⁷ Also, we have the geometric interpretation of difference quotients which was promised to you back on page 215 – a difference quotient yields the slope of a secant line.

⁷So we are not torturing you with these for nothing.

2.1.1 EXERCISES

In Exercises 1 - 10, find both the point-slope form and the slope-intercept form of the line with the given slope which passes through the given point.

- | | |
|-------------------------------------|--------------------------------|
| 1. $m = 3, P(3, -1)$ | 2. $m = -2, P(-5, 8)$ |
| 3. $m = -1, P(-7, -1)$ | 4. $m = \frac{2}{3}, P(-2, 1)$ |
| 5. $m = -\frac{1}{5}, P(10, 4)$ | 6. $m = \frac{1}{7}, P(-1, 4)$ |
| 7. $m = 0, P(3, 117)$ | 8. $m = -\sqrt{2}, P(0, -3)$ |
| 9. $m = -5, P(\sqrt{3}, 2\sqrt{3})$ | 10. $m = 678, P(-1, -12)$ |

In Exercises 11 - 20, find the slope-intercept form of the line which passes through the given points.

- | | |
|---|---|
| 11. $P(0, 0), Q(-3, 5)$ | 12. $P(-1, -2), Q(3, -2)$ |
| 13. $P(5, 0), Q(0, -8)$ | 14. $P(3, -5), Q(7, 4)$ |
| 15. $P(-1, 5), Q(7, 5)$ | 16. $P(4, -8), Q(5, -8)$ |
| 17. $P(\frac{1}{2}, \frac{3}{4}), Q(\frac{5}{2}, -\frac{7}{4})$ | 18. $P(\frac{2}{3}, \frac{7}{2}), Q(-\frac{1}{3}, \frac{3}{2})$ |
| 19. $P(\sqrt{2}, -\sqrt{2}), Q(-\sqrt{2}, \sqrt{2})$ | 20. $P(-\sqrt{3}, -1), Q(\sqrt{3}, 1)$ |

In Exercises 21 - 26, graph the function. Find the slope, y -intercept and x -intercept, if any exist.

- | | |
|---|----------------------------|
| 21. $f(x) = 2x - 1$ | 22. $f(x) = 3 - x$ |
| 23. $f(x) = 3$ | 24. $f(x) = 0$ |
| 25. $f(x) = \frac{2}{3}x + \frac{1}{3}$ | 26. $f(x) = \frac{1-x}{2}$ |
27. Find all of the points on the line $y = 2x + 1$ which are 4 units from the point $(-1, 3)$.
28. Jeff can walk comfortably at 3 miles per hour. Find a linear function d that represents the total distance Jeff can walk in t hours, assuming he doesn't take any breaks.
29. Carl can stuff 6 envelopes per *minute*. Find a linear function E that represents the total number of envelopes Carl can stuff after t *hours*, assuming he doesn't take any breaks.
30. A landscaping company charges \$45 per cubic yard of mulch plus a delivery charge of \$20. Find a linear function which computes the total cost C (in dollars) to deliver x cubic yards of mulch.

31. A plumber charges \$50 for a service call plus \$80 per hour. If she spends no longer than 8 hours a day at any one site, find a linear function that represents her total daily charges C (in dollars) as a function of time t (in hours) spent at any one given location.
32. A salesperson is paid \$200 per week plus 5% commission on her weekly sales of x dollars. Find a linear function that represents her total weekly pay, W (in dollars) in terms of x . What must her weekly sales be in order for her to earn \$475.00 for the week?
33. An on-demand publisher charges \$22.50 to print a 600 page book and \$15.50 to print a 400 page book. Find a linear function which models the cost of a book C as a function of the number of pages p . Interpret the slope of the linear function and find and interpret $C(0)$.
34. The Topology Taxi Company charges \$2.50 for the first fifth of a mile and \$0.45 for each additional fifth of a mile. Find a linear function which models the taxi fare F as a function of the number of miles driven, m . Interpret the slope of the linear function and find and interpret $F(0)$.
35. Water freezes at 0° Celsius and 32° Fahrenheit and it boils at 100°C and 212°F .
 - (a) Find a linear function F that expresses temperature in the Fahrenheit scale in terms of degrees Celsius. Use this function to convert 20°C into Fahrenheit.
 - (b) Find a linear function C that expresses temperature in the Celsius scale in terms of degrees Fahrenheit. Use this function to convert 110°F into Celsius.
 - (c) Is there a temperature n such that $F(n) = C(n)$?
36. Legend has it that a bull Sasquatch in rut will howl approximately 9 times per hour when it is 40°F outside and only 5 times per hour if it's 70°F . Assuming that the number of howls per hour, N , can be represented by a linear function of temperature Fahrenheit, find the number of howls per hour he'll make when it's only 20°F outside. What is the applied domain of this function? Why?
37. Economic forces beyond anyone's control have changed the cost function for PortaBoys to $C(x) = 105x + 175$. Rework Example 2.1.5 with this new cost function.
38. In response to the economic forces in Exercise 37 above, the local retailer sets the selling price of a PortaBoy at \$250. Remarkably, 30 units were sold each week. When the systems went on sale for \$220, 40 units per week were sold. Rework Examples 2.1.6 and 2.1.7 with this new data. What difficulties do you encounter?
39. A local pizza store offers medium two-topping pizzas delivered for \$6.00 per pizza plus a \$1.50 delivery charge per order. On weekends, the store runs a 'game day' special: if six or more medium two-topping pizzas are ordered, they are \$5.50 each with no delivery charge. Write a piecewise-defined linear function which calculates the cost C (in dollars) of p medium two-topping pizzas delivered during a weekend.

40. A restaurant offers a buffet which costs \$15 per person. For parties of 10 or more people, a group discount applies, and the cost is \$12.50 per person. Write a piecewise-defined linear function which calculates the total bill T of a party of n people who all choose the buffet.
41. A mobile plan charges a base monthly rate of \$10 for the first 500 minutes of air time plus a charge of 15¢ for each additional minute. Write a piecewise-defined linear function which calculates the monthly cost C (in dollars) for using m minutes of air time.

HINT: You may want to revisit Exercise 74 in Section 1.4

42. The local pet shop charges 12¢ per cricket up to 100 crickets, and 10¢ per cricket thereafter. Write a piecewise-defined linear function which calculates the price P , in dollars, of purchasing c crickets.
43. The cross-section of a swimming pool is below. Write a piecewise-defined linear function which describes the depth of the pool, D (in feet) as a function of:
- the distance (in feet) from the edge of the shallow end of the pool, d .
 - the distance (in feet) from the edge of the deep end of the pool, s .
 - Graph each of the functions in (a) and (b). Discuss with your classmates how to transform one into the other and how they relate to the diagram of the pool.

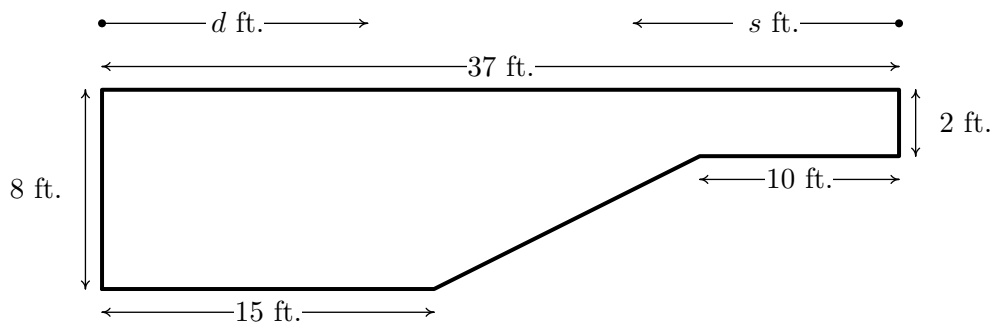

In Exercises 44 - 49, compute the average rate of change of the function over the specified interval.

44. $f(x) = x^3$, $[-1, 2]$
45. $f(x) = \frac{1}{x}$, $[1, 5]$
46. $f(x) = \sqrt{x}$, $[0, 16]$
47. $f(x) = x^2$, $[-3, 3]$
48. $f(x) = \frac{x+4}{x-3}$, $[5, 7]$
49. $f(x) = 3x^2 + 2x - 7$, $[-4, 2]$

In Exercises 50 - 53, compute the average rate of change of the given function over the interval $[x, x + h]$. Here we assume $[x, x + h]$ is in the domain of the function.

50. $f(x) = x^3$

51. $f(x) = \frac{1}{x}$

52. $f(x) = \frac{x + 4}{x - 3}$

53. $f(x) = 3x^2 + 2x - 7$

54. The height of an object dropped from the roof of an eight story building is modeled by: $h(t) = -16t^2 + 64$, $0 \leq t \leq 2$. Here, h is the height of the object off the ground in feet, t seconds after the object is dropped. Find and interpret the average rate of change of h over the interval $[0, 2]$.

55. Using data from [Bureau of Transportation Statistics](#), the average fuel economy F in miles per gallon for passenger cars in the US can be modeled by $F(t) = -0.0076t^2 + 0.45t + 16$, $0 \leq t \leq 28$, where t is the number of years since 1980. Find and interpret the average rate of change of F over the interval $[0, 28]$.

56. The temperature T in degrees Fahrenheit t hours after 6 AM is given by:

$$T(t) = -\frac{1}{2}t^2 + 8t + 32, \quad 0 \leq t \leq 12$$

- (a) Find and interpret $T(4)$, $T(8)$ and $T(12)$.
- (b) Find and interpret the average rate of change of T over the interval $[4, 8]$.
- (c) Find and interpret the average rate of change of T from $t = 8$ to $t = 12$.
- (d) Find and interpret the average rate of temperature change between 10 AM and 6 PM.

57. Suppose $C(x) = x^2 - 10x + 27$ represents the costs, in *hundreds*, to produce x *thousand* pens. Find and interpret the average rate of change as production is increased from making 3000 to 5000 pens.

58. With the help of your classmates find several other “real-world” examples of rates of change that are used to describe non-linear phenomena.

(Parallel Lines) Recall from Intermediate Algebra that parallel lines have the same slope. (Please note that two vertical lines are also parallel to one another even though they have an undefined slope.) In Exercises 59 - 64, you are given a line and a point which is not on that line. Find the line parallel to the given line which passes through the given point.

59. $y = 3x + 2$, $P(0, 0)$

60. $y = -6x + 5$, $P(3, 2)$

61. $y = \frac{2}{3}x - 7, P(6, 0)$

62. $y = \frac{4-x}{3}, P(1, -1)$

63. $y = 6, P(3, -2)$

64. $x = 1, P(-5, 0)$

(Perpendicular Lines) Recall from Intermediate Algebra that two non-vertical lines are perpendicular if and only if they have negative reciprocal slopes. That is to say, if one line has slope m_1 and the other has slope m_2 then $m_1 \cdot m_2 = -1$. (You will be guided through a proof of this result in Exercise 71.) Please note that a horizontal line is perpendicular to a vertical line and vice versa, so we assume $m_1 \neq 0$ and $m_2 \neq 0$. In Exercises 65 - 70, you are given a line and a point which is not on that line. Find the line perpendicular to the given line which passes through the given point.

65. $y = \frac{1}{3}x + 2, P(0, 0)$

66. $y = -6x + 5, P(3, 2)$

67. $y = \frac{2}{3}x - 7, P(6, 0)$

68. $y = \frac{4-x}{3}, P(1, -1)$

69. $y = 6, P(3, -2)$

70. $x = 1, P(-5, 0)$

71. We shall now prove that $y = m_1x + b_1$ is perpendicular to $y = m_2x + b_2$ if and only if $m_1 \cdot m_2 = -1$. To make our lives easier we shall assume that $m_1 > 0$ and $m_2 < 0$. We can also “move” the lines so that their point of intersection is the origin without messing things up, so we’ll assume $b_1 = b_2 = 0$. (Take a moment with your classmates to discuss why this is okay.) Graphing the lines and plotting the points $O(0, 0)$, $P(1, m_1)$ and $Q(1, m_2)$ gives us the following set up.

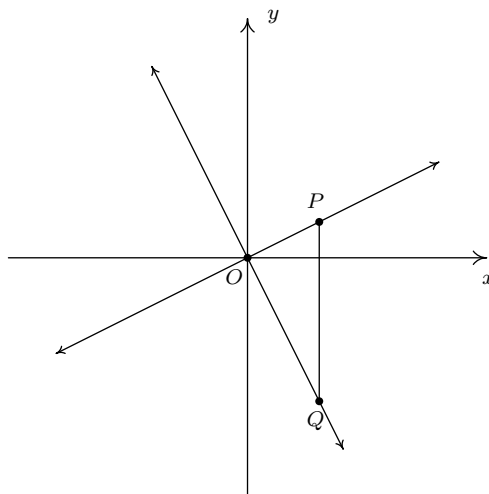

The line $y = m_1x$ will be perpendicular to the line $y = m_2x$ if and only if $\triangle OPQ$ is a right triangle. Let d_1 be the distance from O to P , let d_2 be the distance from O to Q and let d_3 be the distance from P to Q . Use the Pythagorean Theorem to show that $\triangle OPQ$ is a right triangle if and only if $m_1 \cdot m_2 = -1$ by showing $d_1^2 + d_2^2 = d_3^2$ if and only if $m_1 \cdot m_2 = -1$.

72. Show that if $a \neq b$, the line containing the points (a, b) and (b, a) is perpendicular to the line $y = x$. (Coupled with the result from Example 1.1.7 on page 147, we have now shown that the line $y = x$ is a *perpendicular* bisector of the line segment connecting (a, b) and (b, a) . This means the points (a, b) and (b, a) are symmetric about the line $y = x$. We will revisit this symmetry in section 5.2.)
73. The function defined by $I(x) = x$ is called the Identity Function.
- (a) Discuss with your classmates why this name makes sense.
 - (b) Show that the point-slope form of a line (Equation 2.2) can be obtained from I using a sequence of the transformations defined in Section 1.7.

2.1.2 ANSWERS

$$1. \begin{aligned} y + 1 &= 3(x - 3) \\ y &= 3x - 10 \end{aligned}$$

$$3. \begin{aligned} y + 1 &= -(x + 7) \\ y &= -x - 8 \end{aligned}$$

$$5. \begin{aligned} y - 4 &= -\frac{1}{5}(x - 10) \\ y &= -\frac{1}{5}x + 6 \end{aligned}$$

$$7. \begin{aligned} y - 117 &= 0 \\ y &= 117 \end{aligned}$$

$$9. \begin{aligned} y - 2\sqrt{3} &= -5(x - \sqrt{3}) \\ y &= -5x + 7\sqrt{3} \end{aligned}$$

$$11. y = -\frac{5}{3}x$$

$$13. y = \frac{8}{5}x - 8$$

$$15. y = 5$$

$$17. y = -\frac{5}{4}x + \frac{11}{8}$$

$$19. y = -x$$

$$21. \begin{aligned} f(x) &= 2x - 1 \\ \text{slope: } m &= 2 \\ y\text{-intercept: } &(0, -1) \\ x\text{-intercept: } &(\frac{1}{2}, 0) \end{aligned}$$

$$2. \begin{aligned} y - 8 &= -2(x + 5) \\ y &= -2x - 2 \end{aligned}$$

$$4. \begin{aligned} y - 1 &= \frac{2}{3}(x + 2) \\ y &= \frac{2}{3}x + \frac{7}{3} \end{aligned}$$

$$6. \begin{aligned} y - 4 &= \frac{1}{7}(x + 1) \\ y &= \frac{1}{7}x + \frac{29}{7} \end{aligned}$$

$$8. \begin{aligned} y + 3 &= -\sqrt{2}(x - 0) \\ y &= -\sqrt{2}x - 3 \end{aligned}$$

$$10. \begin{aligned} y + 12 &= 678(x + 1) \\ y &= 678x + 666 \end{aligned}$$

$$12. y = -2$$

$$14. y = \frac{9}{4}x - \frac{47}{4}$$

$$16. y = -8$$

$$18. y = 2x + \frac{13}{6}$$

$$20. y = \frac{\sqrt{3}}{3}x$$

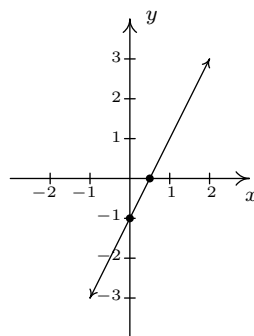

$$22. \begin{aligned} f(x) &= 3 - x \\ \text{slope: } m &= -1 \\ y\text{-intercept: } &(0, 3) \\ x\text{-intercept: } &(3, 0) \end{aligned}$$

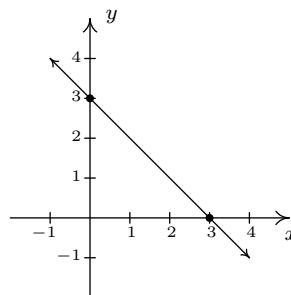

23. $f(x) = 3$

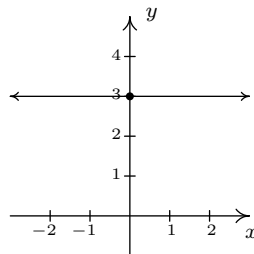
slope: $m = 0$ y -intercept: $(0, 3)$ x -intercept: none

24. $f(x) = 0$

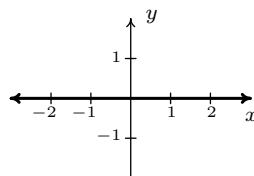
slope: $m = 0$ y -intercept: $(0, 0)$ x -intercept: $\{(x, 0) \mid x \text{ is a real number}\}$ 

25. $f(x) = \frac{2}{3}x + \frac{1}{3}$

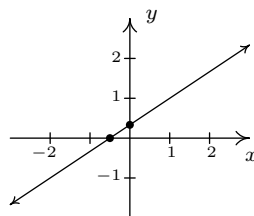
slope: $m = \frac{2}{3}$ y -intercept: $(0, \frac{1}{3})$ x -intercept: $(-\frac{1}{2}, 0)$ 

26. $f(x) = \frac{1-x}{2}$

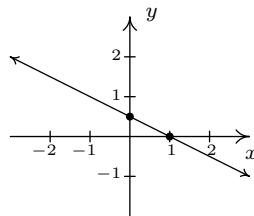
slope: $m = -\frac{1}{2}$ y -intercept: $(0, \frac{1}{2})$ x -intercept: $(1, 0)$ 

27. $(-1, -1)$ and $(\frac{11}{5}, \frac{27}{5})$

28. $d(t) = 3t, t \geq 0$.

29. $E(t) = 360t, t \geq 0$.

30. $C(x) = 45x + 20, x \geq 0$.

31. $C(t) = 80t + 50, 0 \leq t \leq 8$.

32. $W(x) = 200 + .05x, x \geq 0$ She must make \$5500 in weekly sales.

33. $C(p) = 0.035p + 1.5$ The slope 0.035 means it costs 3.5¢ per page. $C(0) = 1.5$ means there is a fixed, or start-up, cost of \$1.50 to make each book.

34. $F(m) = 2.25m + 2.05$ The slope 2.25 means it costs an additional \$2.25 for each mile beyond the first 0.2 miles. $F(0) = 2.05$, so according to the model, it would cost \$2.05 for a trip of 0 miles. Would this ever really happen? Depends on the driver and the passenger, we suppose.

$$35. \quad (a) \quad F(C) = \frac{9}{5}C + 32 \qquad (b) \quad C(F) = \frac{5}{9}(F - 32) = \frac{5}{9}F - \frac{160}{9}$$

$$(c) \quad F(-40) = -40 = C(-40).$$

$$36. \quad N(T) = -\frac{2}{15}T + \frac{43}{3} \text{ and } N(20) = \frac{35}{3} \approx 12 \text{ howls per hour.}$$

Having a negative number of howls makes no sense and since $N(107.5) = 0$ we can put an upper bound of $107.5^\circ F$ on the domain. The lower bound is trickier because there's nothing other than common sense to go on. As it gets colder, he howls more often. At some point it will either be so cold that he freezes to death or he's howling non-stop. So we're going to say that he can withstand temperatures no lower than $-60^\circ F$ so that the applied domain is $[-60, 107.5]$.

$$39. \quad C(p) = \begin{cases} 6p + 1.5 & \text{if } 1 \leq p \leq 5 \\ 5.5p & \text{if } p \geq 6 \end{cases}$$

$$40. \quad T(n) = \begin{cases} 15n & \text{if } 1 \leq n \leq 9 \\ 12.5n & \text{if } n \geq 10 \end{cases}$$

$$41. \quad C(m) = \begin{cases} 10 & \text{if } 0 \leq m \leq 500 \\ 10 + 0.15(m - 500) & \text{if } m > 500 \end{cases}$$

$$42. \quad P(c) = \begin{cases} 0.12c & \text{if } 1 \leq c \leq 100 \\ 12 + 0.1(c - 100) & \text{if } c > 100 \end{cases}$$

$$43. \quad (a)$$

$$D(d) = \begin{cases} 8 & \text{if } 0 \leq d \leq 15 \\ -\frac{1}{2}d + \frac{31}{2} & \text{if } 15 \leq d \leq 27 \\ 2 & \text{if } 27 \leq d \leq 37 \end{cases}$$

$$(b)$$

$$D(s) = \begin{cases} 2 & \text{if } 0 \leq s \leq 10 \\ \frac{1}{2}s - 3 & \text{if } 10 \leq s \leq 22 \\ 8 & \text{if } 22 \leq s \leq 37 \end{cases}$$

$$(c)$$

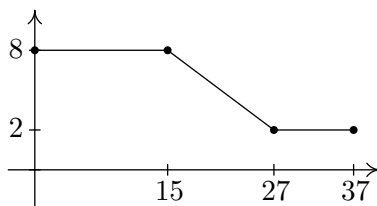
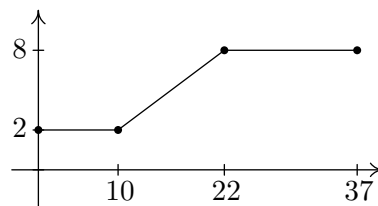
 $y = D(d)$

 $y = D(s)$

44. $\frac{2^3 - (-1)^3}{2 - (-1)} = 3$

45. $\frac{\frac{1}{5} - \frac{1}{1}}{5 - 1} = -\frac{1}{5}$

46. $\frac{\sqrt{16} - \sqrt{0}}{16 - 0} = \frac{1}{4}$

47. $\frac{3^2 - (-3)^2}{3 - (-3)} = 0$

48. $\frac{\frac{7+4}{7-3} - \frac{5+4}{5-3}}{7-5} = -\frac{7}{8}$

49. $\frac{(3(2)^2 + 2(2) - 7) - (3(-4)^2 + 2(-4) - 7)}{2 - (-4)} = -4$

50. $3x^2 + 3xh + h^2$

51. $\frac{-1}{x(x+h)}$

52. $\frac{-7}{(x-3)(x+h-3)}$

53. $6x + 3h + 2$

54. The average rate of change is $\frac{h(2)-h(0)}{2-0} = -32$. During the first two seconds after it is dropped, the object has fallen at an average rate of 32 feet per second. (This is called the *average velocity* of the object.)

55. The average rate of change is $\frac{F(28)-F(0)}{28-0} = 0.2372$. During the years from 1980 to 2008, the average fuel economy of passenger cars in the US increased, on average, at a rate of 0.2372 miles per gallon per year.

56. (a) $T(4) = 56$, so at 10 AM (4 hours after 6 AM), it is 56°F. $T(8) = 64$, so at 2 PM (8 hours after 6 AM), it is 64°F. $T(12) = 56$, so at 6 PM (12 hours after 6 AM), it is 56°F.

(b) The average rate of change is $\frac{T(8)-T(4)}{8-4} = 2$. Between 10 AM and 2 PM, the temperature increases, on average, at a rate of 2°F per hour.

(c) The average rate of change is $\frac{T(12)-T(8)}{12-8} = -2$. Between 2 PM and 6 PM, the temperature decreases, on average, at a rate of 2°F per hour.

(d) The average rate of change is $\frac{T(12)-T(4)}{12-4} = 0$. Between 10 AM and 6 PM, the temperature, on average, remains constant.

57. The average rate of change is $\frac{C(5)-C(3)}{5-3} = -2$. As production is increased from 3000 to 5000 pens, the cost decreases at an average rate of \$200 per 1000 pens produced (20¢ per pen.)

59. $y = 3x$

60. $y = -6x + 20$

61. $y = \frac{2}{3}x - 4$

62. $y = -\frac{1}{3}x - \frac{2}{3}$

63. $y = -2$

64. $x = -5$

65. $y = -3x$

66. $y = \frac{1}{6}x + \frac{3}{2}$

67. $y = -\frac{3}{2}x + 9$

68. $y = 3x - 4$

69. $x = 3$

70. $y = 0$

2.2 ABSOLUTE VALUE FUNCTIONS

There are a few ways to describe what is meant by the absolute value $|x|$ of a real number x . You may have been taught that $|x|$ is the distance from the real number x to 0 on the number line. So, for example, $|5| = 5$ and $|-5| = 5$, since each is 5 units from 0 on the number line.

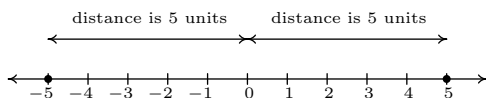

Another way to define absolute value is by the equation $|x| = \sqrt{x^2}$. Using this definition, we have $|5| = \sqrt{(5)^2} = \sqrt{25} = 5$ and $|-5| = \sqrt{(-5)^2} = \sqrt{25} = 5$. The long and short of both of these procedures is that $|x|$ takes negative real numbers and assigns them to their positive counterparts while it leaves positive numbers alone. This last description is the one we shall adopt, and is summarized in the following definition.

Definition 2.4. The **absolute value** of a real number x , denoted $|x|$, is given by

$$|x| = \begin{cases} -x, & \text{if } x < 0 \\ x, & \text{if } x \geq 0 \end{cases}$$

In Definition 2.4, we define $|x|$ using a piecewise-defined function. (See page 196 in Section 1.4.) To check that this definition agrees with what we previously understood as absolute value, note that since $5 \geq 0$, to find $|5|$ we use the rule $|x| = x$, so $|5| = 5$. Similarly, since $-5 < 0$, we use the rule $|x| = -x$, so that $|-5| = -(-5) = 5$. This is one of the times when it's best to interpret the expression ' $-x$ ' as 'the opposite of x ' as opposed to 'negative x '. Before we begin studying absolute value functions, we remind ourselves of the properties of absolute value.

Theorem 2.1. Properties of Absolute Value: Let a , b and x be real numbers and let n be an integer.^a Then

- **Product Rule:** $|ab| = |a||b|$
- **Power Rule:** $|a^n| = |a|^n$ whenever a^n is defined
- **Quotient Rule:** $\left|\frac{a}{b}\right| = \frac{|a|}{|b|}$, provided $b \neq 0$

Equality Properties:

- $|x| = 0$ if and only if $x = 0$.
- For $c > 0$, $|x| = c$ if and only if $x = c$ or $-x = c$.
- For $c < 0$, $|x| = c$ has no solution.

^aSee page 136 if you don't remember what an integer is.

The proofs of the Product and Quotient Rules in Theorem 2.1 boil down to checking four cases: when both a and b are positive; when they are both negative; when one is positive and the other is negative; and when one or both are zero.

For example, suppose we wish to show that $|ab| = |a||b|$. We need to show that this equation is true for all real numbers a and b . If a and b are both positive, then so is ab . Hence, $|a| = a$, $|b| = b$ and $|ab| = ab$. Hence, the equation $|ab| = |a||b|$ is the same as $ab = ab$ which is true. If both a and b are negative, then ab is positive. Hence, $|a| = -a$, $|b| = -b$ and $|ab| = ab$. The equation $|ab| = |a||b|$ becomes $ab = (-a)(-b)$, which is true. Suppose a is positive and b is negative. Then ab is negative, and we have $|ab| = -ab$, $|a| = a$ and $|b| = -b$. The equation $|ab| = |a||b|$ reduces to $-ab = a(-b)$ which is true. A symmetric argument shows the equation $|ab| = |a||b|$ holds when a is negative and b is positive. Finally, if either a or b (or both) are zero, then both sides of $|ab| = |a||b|$ are zero, so the equation holds in this case, too. All of this rhetoric has shown that the equation $|ab| = |a||b|$ holds true in all cases.

The proof of the Quotient Rule is very similar, with the exception that $b \neq 0$. The Power Rule can be shown by repeated application of the Product Rule. The ‘Equality Properties’ can be proved using Definition 2.4 and by looking at the cases when $x \geq 0$, in which case $|x| = x$, or when $x < 0$, in which case $|x| = -x$. For example, if $c > 0$, and $|x| = c$, then if $x \geq 0$, we have $x = |x| = c$. If, on the other hand, $x < 0$, then $-x = |x| = c$, so $x = -c$. The remaining properties are proved similarly and are left for the Exercises. Our first example reviews how to solve basic equations involving absolute value using the properties listed in Theorem 2.1.

Example 2.2.1. Solve each of the following equations.

1. $|3x - 1| = 6$

2. $3 - |x + 5| = 1$

3. $3|2x + 1| - 5 = 0$

4. $4 - |5x + 3| = 5$

5. $|x| = x^2 - 6$

6. $|x - 2| + 1 = x$

Solution.

- The equation $|3x - 1| = 6$ is of the form $|x| = c$ for $c > 0$, so by the Equality Properties, $|3x - 1| = 6$ is equivalent to $3x - 1 = 6$ or $3x - 1 = -6$. Solving the former, we arrive at $x = \frac{7}{3}$, and solving the latter, we get $x = -\frac{5}{3}$. We may check both of these solutions by substituting them into the original equation and showing that the arithmetic works out.
- To use the Equality Properties to solve $3 - |x + 5| = 1$, we first isolate the absolute value.

$$\begin{aligned} 3 - |x + 5| &= 1 \\ -|x + 5| &= -2 && \text{subtract 3} \\ |x + 5| &= 2 && \text{divide by } -1 \end{aligned}$$

From the Equality Properties, we have $x + 5 = 2$ or $x + 5 = -2$, and get our solutions to be $x = -3$ or $x = -7$. We leave it to the reader to check both answers in the original equation.

3. As in the previous example, we first isolate the absolute value in the equation $3|2x+1|-5=0$ and get $|2x+1|=\frac{5}{3}$. Using the Equality Properties, we have $2x+1=\frac{5}{3}$ or $2x+1=-\frac{5}{3}$. Solving the former gives $x=\frac{1}{3}$ and solving the latter gives $x=-\frac{4}{3}$. As usual, we may substitute both answers in the original equation to check.
4. Upon isolating the absolute value in the equation $4-|5x+3|=5$, we get $|5x+3|=-1$. At this point, we know there cannot be any real solution, since, by definition, the absolute value of *anything* is never negative. We are done.
5. The equation $|x|=x^2-6$ presents us with some difficulty, since x appears both inside and outside of the absolute value. Moreover, there are values of x for which x^2-6 is positive, negative and zero, so we cannot use the Equality Properties without the risk of introducing extraneous solutions, or worse, losing solutions. For this reason, we break equations like this into cases by rewriting the term in absolute values, $|x|$, using Definition 2.4. For $x < 0$, $|x| = -x$, so for $x < 0$, the equation $|x| = x^2 - 6$ is equivalent to $-x = x^2 - 6$. Rearranging this gives us $x^2 + x - 6 = 0$, or $(x+3)(x-2) = 0$. We get $x = -3$ or $x = 2$. Since only $x = -3$ satisfies $x < 0$, this is the answer we keep. For $x \geq 0$, $|x| = x$, so the equation $|x| = x^2 - 6$ becomes $x = x^2 - 6$. From this, we get $x^2 - x - 6 = 0$ or $(x-3)(x+2) = 0$. Our solutions are $x = 3$ or $x = -2$, and since only $x = 3$ satisfies $x \geq 0$, this is the one we keep. Hence, our two solutions to $|x| = x^2 - 6$ are $x = -3$ and $x = 3$.
6. To solve $|x-2|+1=x$, we first isolate the absolute value and get $|x-2|=x-1$. Since we see x both inside and outside of the absolute value, we break the equation into cases. The term with absolute values here is $|x-2|$, so we replace ' x ' with the quantity ' $(x-2)$ ' in Definition 2.4 to get

$$|x-2| = \begin{cases} -(x-2), & \text{if } (x-2) < 0 \\ (x-2), & \text{if } (x-2) \geq 0 \end{cases}$$

Simplifying yields

$$|x-2| = \begin{cases} -x+2, & \text{if } x < 2 \\ x-2, & \text{if } x \geq 2 \end{cases}$$

So, for $x < 2$, $|x-2| = -x+2$ and our equation $|x-2| = x-1$ becomes $-x+2 = x-1$, which gives $x = \frac{3}{2}$. Since this solution satisfies $x < 2$, we keep it. Next, for $x \geq 2$, $|x-2| = x-2$, so the equation $|x-2| = x-1$ becomes $x-2 = x-1$. Here, the equation reduces to $-2 = -1$, which signifies we have no solutions here. Hence, our only solution is $x = \frac{3}{2}$. \square

Next, we turn our attention to graphing absolute value functions. Our strategy in the next example is to make liberal use of Definition 2.4 along with what we know about graphing linear functions (from Section 2.1) and piecewise-defined functions (from Section 1.4).

Example 2.2.2. Graph each of the following functions.

1. $f(x) = |x|$
2. $g(x) = |x-3|$
3. $h(x) = |x|-3$
4. $i(x) = 4-2|3x+1|$

Find the zeros of each function and the x - and y -intercepts of each graph, if any exist. From the graph, determine the domain and range of each function, list the intervals on which the function is increasing, decreasing or constant, and find the relative and absolute extrema, if they exist.

Solution.

1. To find the zeros of f , we set $f(x) = 0$. We get $|x| = 0$, which, by Theorem 2.1 gives us $x = 0$. Since the zeros of f are the x -coordinates of the x -intercepts of the graph of $y = f(x)$, we get $(0, 0)$ as our only x -intercept. To find the y -intercept, we set $x = 0$, and find $y = f(0) = 0$, so that $(0, 0)$ is our y -intercept as well.¹ Using Definition 2.4, we get

$$f(x) = |x| = \begin{cases} -x, & \text{if } x < 0 \\ x, & \text{if } x \geq 0 \end{cases}$$

Hence, for $x < 0$, we are graphing the line $y = -x$; for $x \geq 0$, we have the line $y = x$. Proceeding as we did in Section 1.6, we get

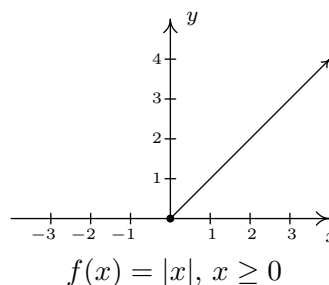
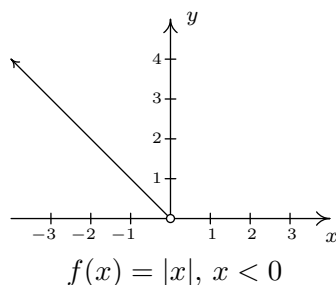

Notice that we have an ‘open circle’ at $(0, 0)$ in the graph when $x < 0$. As we have seen before, this is due to the fact that the points on $y = -x$ approach $(0, 0)$ as the x -values approach 0. Since x is required to be strictly less than zero on this stretch, the open circle is drawn at the origin. However, notice that when $x \geq 0$, we get to fill in the point at $(0, 0)$, which effectively ‘plugs’ the hole indicated by the open circle. Thus we get,

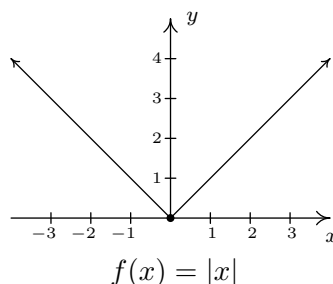

¹Actually, since functions can have at most one y -intercept (Do you know why?), as soon as we found $(0, 0)$ as the x -intercept, we knew this was also the y -intercept.

By projecting the graph to the x -axis, we see that the domain is $(-\infty, \infty)$. Projecting to the y -axis gives us the range $[0, \infty)$. The function is increasing on $[0, \infty)$ and decreasing on $(-\infty, 0]$. The relative minimum value of f is the same as the absolute minimum, namely 0 which occurs at $(0, 0)$. There is no relative maximum value of f . There is also no absolute maximum value of f , since the y values on the graph extend infinitely upwards.

2. To find the zeros of g , we set $g(x) = |x - 3| = 0$. By Theorem 2.1, we get $x - 3 = 0$ so that $x = 3$. Hence, the x -intercept is $(3, 0)$. To find our y -intercept, we set $x = 0$ so that $y = g(0) = |0 - 3| = 3$, which yields $(0, 3)$ as our y -intercept. To graph $g(x) = |x - 3|$, we use Definition 2.4 to rewrite g as

$$g(x) = |x - 3| = \begin{cases} -(x - 3), & \text{if } (x - 3) < 0 \\ (x - 3), & \text{if } (x - 3) \geq 0 \end{cases}$$

Simplifying, we get

$$g(x) = \begin{cases} -x + 3, & \text{if } x < 3 \\ x - 3, & \text{if } x \geq 3 \end{cases}$$

As before, the open circle we introduce at $(3, 0)$ from the graph of $y = -x + 3$ is filled by the point $(3, 0)$ from the line $y = x - 3$. We determine the domain as $(-\infty, \infty)$ and the range as $[0, \infty)$. The function g is increasing on $[3, \infty)$ and decreasing on $(-\infty, 3]$. The relative and absolute minimum value of g is 0 which occurs at $(3, 0)$. As before, there is no relative or absolute maximum value of g .

3. Setting $h(x) = 0$ to look for zeros gives $|x| - 3 = 0$. As in Example 2.2.1, we isolate the absolute value to get $|x| = 3$ so that $x = 3$ or $x = -3$. As a result, we have a pair of x -intercepts: $(-3, 0)$ and $(3, 0)$. Setting $x = 0$ gives $y = h(0) = |0| - 3 = -3$, so our y -intercept is $(0, -3)$. As before, we rewrite the absolute value in h to get

$$h(x) = \begin{cases} -x - 3, & \text{if } x < 0 \\ x - 3, & \text{if } x \geq 0 \end{cases}$$

Once again, the open circle at $(0, -3)$ from one piece of the graph of h is filled by the point $(0, -3)$ from the other piece of h . From the graph, we determine the domain of h is $(-\infty, \infty)$ and the range is $[-3, \infty)$. On $[0, \infty)$, h is increasing; on $(-\infty, 0]$ it is decreasing. The relative minimum occurs at the point $(0, -3)$ on the graph, and we see -3 is both the relative and absolute minimum value of h . Also, h has no relative or absolute maximum value.

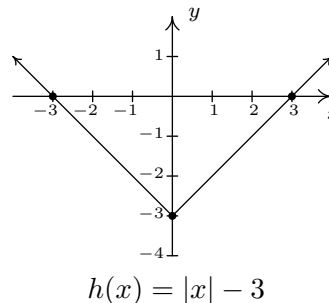
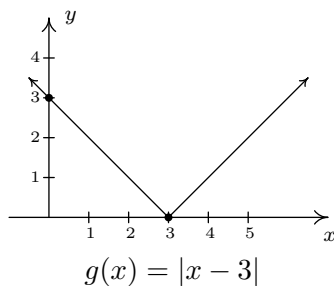

4. As before, we set $i(x) = 0$ to find the zeros of i and get $4 - 2|3x + 1| = 0$. Isolating the absolute value term gives $|3x + 1| = 2$, so either $3x + 1 = 2$ or $3x + 1 = -2$. We get $x = \frac{1}{3}$ or $x = -1$, so our x -intercepts are $(\frac{1}{3}, 0)$ and $(-1, 0)$. Substituting $x = 0$ gives $y = i(0) = 4 - 2|3(0) + 1| = 2$, for a y -intercept of $(0, 2)$. Rewriting the formula for $i(x)$ without absolute values gives

$$i(x) = \begin{cases} 4 - 2(-(3x + 1)), & \text{if } (3x + 1) < 0 \\ 4 - 2(3x + 1), & \text{if } (3x + 1) \geq 0 \end{cases} = \begin{cases} 6x + 6, & \text{if } x < -\frac{1}{3} \\ -6x + 2, & \text{if } x \geq -\frac{1}{3} \end{cases}$$

The usual analysis near the trouble spot $x = -\frac{1}{3}$ gives the ‘corner’ of this graph is $(-\frac{1}{3}, 4)$, and we get the distinctive ‘V’ shape:

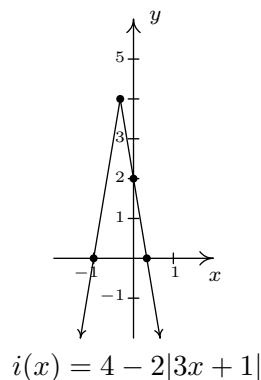

The domain of i is $(-\infty, \infty)$ while the range is $(-\infty, 4]$. The function i is increasing on $(-\infty, -\frac{1}{3}]$ and decreasing on $[-\frac{1}{3}, \infty)$. The relative maximum occurs at the point $(-\frac{1}{3}, 4)$ and the relative and absolute maximum value of i is 4. Since the graph of i extends downwards forever more, there is no absolute minimum value. As we can see from the graph, there is no relative minimum, either. \square

Note that all of the functions in the previous example bear the characteristic ‘V’ shape of the graph of $y = |x|$. We could have graphed the functions g , h and i in Example 2.2.2 starting with the graph of $f(x) = |x|$ and applying transformations as in Section 1.7 as our next example illustrates.

Example 2.2.3. Graph the following functions starting with the graph of $f(x) = |x|$ and using transformations.

1. $g(x) = |x - 3|$

2. $h(x) = |x| - 3$

3. $i(x) = 4 - 2|3x + 1|$

Solution. We begin by graphing $f(x) = |x|$ and labeling three points, $(-1, 1)$, $(0, 0)$ and $(1, 1)$.

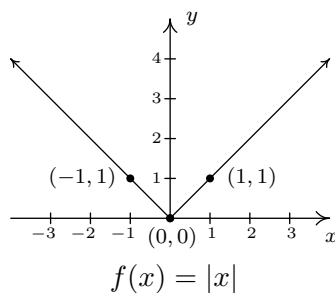

1. Since $g(x) = |x - 3| = f(x - 3)$, Theorem 1.7 tells us to *add 3* to each of the x -values of the points on the graph of $y = f(x)$ to obtain the graph of $y = g(x)$. This shifts the graph of $y = f(x)$ to the *right* 3 units and moves the point $(-1, 1)$ to $(2, 1)$, $(0, 0)$ to $(3, 0)$ and $(1, 1)$ to $(4, 1)$. Connecting these points in the classic ‘ \vee ’ fashion produces the graph of $y = g(x)$.

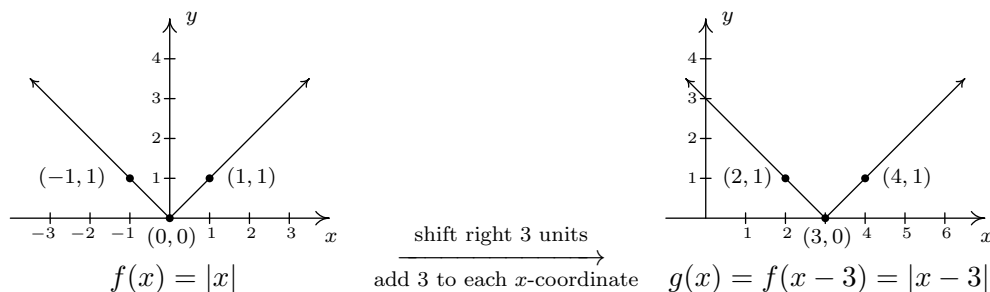

2. For $h(x) = |x| - 3 = f(x) - 3$, Theorem 1.7 tells us to *subtract 3* from each of the y -values of the points on the graph of $y = f(x)$ to obtain the graph of $y = h(x)$. This shifts the graph of $y = f(x)$ *down* 3 units and moves $(-1, 1)$ to $(-1, -2)$, $(0, 0)$ to $(0, -3)$ and $(1, 1)$ to $(1, -2)$. Connecting these points with the ‘ \vee ’ shape produces our graph of $y = h(x)$.

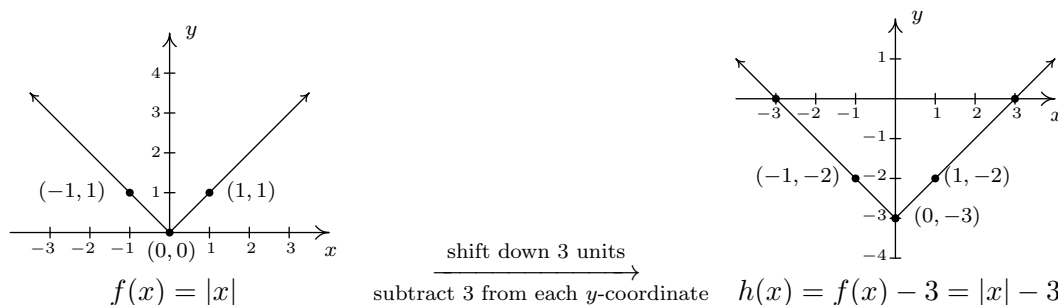

3. We re-write $i(x) = 4 - 2|3x + 1| = 4 - 2f(3x + 1) = -2f(3x + 1) + 4$ and apply Theorem 1.7. First, we take care of the changes on the ‘inside’ of the absolute value. Instead of $|x|$, we have $|3x + 1|$, so, in accordance with Theorem 1.7, we first *subtract* 1 from each of the x -values of points on the graph of $y = f(x)$, then *divide* each of those new values by 3. This effects a horizontal shift *left* 1 unit followed by a horizontal *shrink* by a factor of 3. These transformations move $(-1, 1)$ to $(-\frac{2}{3}, 1)$, $(0, 0)$ to $(-\frac{1}{3}, 0)$ and $(1, 1)$ to $(0, 1)$. Next, we take care of what’s happening ‘outside of’ the absolute value. Theorem 1.7 instructs us to first *multiply* each y -value of these new points by -2 then *add* 4. Geometrically, this corresponds to a vertical *stretch* by a factor of 2, a reflection across the x -axis and finally, a vertical shift *up* 4 units. These transformations move $(-\frac{2}{3}, 1)$ to $(-\frac{2}{3}, 2)$, $(-\frac{1}{3}, 0)$ to $(-\frac{1}{3}, 4)$, and $(0, 1)$ to $(0, 2)$. Connecting these points with the usual ‘ \vee ’ shape produces our graph of $y = i(x)$.

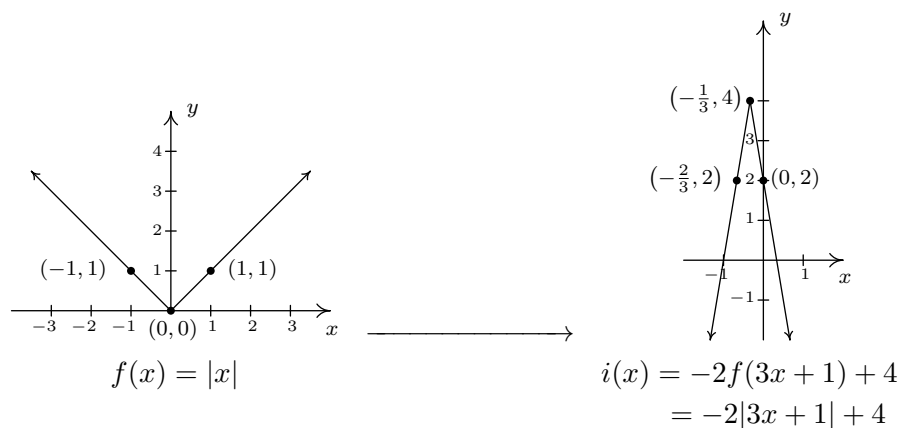

□

While the methods in Section 1.7 can be used to graph an entire family of absolute value functions, not all functions involving absolute values possess the characteristic ‘ \vee ’ shape. As the next example illustrates, often there is no substitute for appealing directly to the definition.

Example 2.2.4. Graph each of the following functions. Find the zeros of each function and the x - and y -intercepts of each graph, if any exist. From the graph, determine the domain and range of each function, list the intervals on which the function is increasing, decreasing or constant, and find the relative and absolute extrema, if they exist.

1. $f(x) = \frac{|x|}{x}$

2. $g(x) = |x + 2| - |x - 3| + 1$

Solution.

1. We first note that, due to the fraction in the formula of $f(x)$, $x \neq 0$. Thus the domain is $(-\infty, 0) \cup (0, \infty)$. To find the zeros of f , we set $f(x) = \frac{|x|}{x} = 0$. This last equation implies $|x| = 0$, which, from Theorem 2.1, implies $x = 0$. However, $x = 0$ is not in the domain of f ,

which means we have, in fact, no x -intercepts. We have no y -intercepts either, since $f(0)$ is undefined. Re-writing the absolute value in the function gives

$$f(x) = \begin{cases} \frac{-x}{x}, & \text{if } x < 0 \\ \frac{x}{x}, & \text{if } x > 0 \end{cases} = \begin{cases} -1, & \text{if } x < 0 \\ 1, & \text{if } x > 0 \end{cases}$$

To graph this function, we graph two horizontal lines: $y = -1$ for $x < 0$ and $y = 1$ for $x > 0$. We have open circles at $(0, -1)$ and $(0, 1)$ (Can you explain why?) so we get

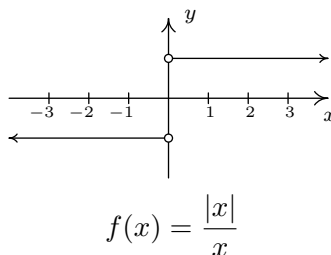

As we found earlier, the domain is $(-\infty, 0) \cup (0, \infty)$. The range consists of just two y -values: $\{-1, 1\}$. The function f is constant on $(-\infty, 0)$ and $(0, \infty)$. The local minimum value of f is the absolute minimum value of f , namely -1 ; the local maximum and absolute maximum values for f also coincide – they both are 1 . Every point on the graph of f is simultaneously a relative maximum and a relative minimum. (Can you remember why in light of Definition 1.11? This was explored in the Exercises in Section 1.6.2.)

2. To find the zeros of g , we set $g(x) = 0$. The result is $|x + 2| - |x - 3| + 1 = 0$. Attempting to isolate the absolute value term is complicated by the fact that there are **two** terms with absolute values. In this case, it is easier to proceed using cases by re-writing the function g with two separate applications of Definition 2.4 to remove each instance of the absolute values, one at a time. In the first round we get

$$g(x) = \begin{cases} -(x + 2) - |x - 3| + 1, & \text{if } (x + 2) < 0 \\ (x + 2) - |x - 3| + 1, & \text{if } (x + 2) \geq 0 \end{cases} = \begin{cases} -x - 1 - |x - 3|, & \text{if } x < -2 \\ x + 3 - |x - 3|, & \text{if } x \geq -2 \end{cases}$$

Given that

$$|x - 3| = \begin{cases} -(x - 3), & \text{if } (x - 3) < 0 \\ x - 3, & \text{if } (x - 3) \geq 0 \end{cases} = \begin{cases} -x + 3, & \text{if } x < 3 \\ x - 3, & \text{if } x \geq 3 \end{cases},$$

we need to break up the domain again at $x = 3$. Note that if $x < -2$, then $x < 3$, so we replace $|x - 3|$ with $-x + 3$ for that part of the domain, too. Our completed revision of the form of g yields

$$g(x) = \begin{cases} -x - 1 - (-x + 3), & \text{if } x < -2 \\ x + 3 - (-x + 3), & \text{if } x \geq -2 \text{ and } x < 3 \\ x + 3 - (x - 3), & \text{if } x \geq 3 \end{cases} = \begin{cases} -4, & \text{if } x < -2 \\ 2x, & \text{if } -2 \leq x < 3 \\ 6, & \text{if } x \geq 3 \end{cases}$$

To solve $g(x) = 0$, we see that the only piece which contains a variable is $g(x) = 2x$ for $-2 \leq x < 3$. Solving $2x = 0$ gives $x = 0$. Since $x = 0$ is in the interval $[-2, 3)$, we keep this solution and have $(0, 0)$ as our only x -intercept. Accordingly, the y -intercept is also $(0, 0)$. To graph g , we start with $x < -2$ and graph the horizontal line $y = -4$ with an open circle at $(-2, -4)$. For $-2 \leq x < 3$, we graph the line $y = 2x$ and the point $(-2, -4)$ patches the hole left by the previous piece. An open circle at $(3, 6)$ completes the graph of this part. Finally, we graph the horizontal line $y = 6$ for $x \geq 3$, and the point $(3, 6)$ fills in the open circle left by the previous part of the graph. The finished graph is

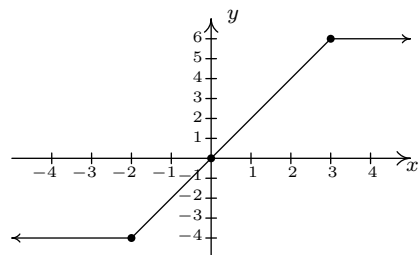

$$g(x) = |x + 2| - |x - 3| + 1$$

The domain of g is all real numbers, $(-\infty, \infty)$, and the range of g is all real numbers between -4 and 6 inclusive, $[-4, 6]$. The function is increasing on $[-2, 3]$ and constant on $(-\infty, -2]$ and $[3, \infty)$. The relative minimum value of f is -4 which matches the absolute minimum. The relative and absolute maximum values also coincide at 6 . Every point on the graph of $y = g(x)$ for $x < -2$ and $x > 3$ yields both a relative minimum and relative maximum. The point $(-2, -4)$, however, gives only a relative minimum and the point $(3, 6)$ yields only a relative maximum. (Recall the Exercises in Section 1.6.2 which dealt with constant functions.) \square

Many of the applications that the authors are aware of involving absolute values also involve absolute value inequalities. For that reason, we save our discussion of applications for Section 2.4.

2.2.1 EXERCISES

In Exercises 1 - 15, solve the equation.

1. $|x| = 6$

2. $|3x - 1| = 10$

3. $|4 - x| = 7$

4. $4 - |x| = 3$

5. $2|5x + 1| - 3 = 0$

6. $|7x - 1| + 2 = 0$

7. $\frac{5 - |x|}{2} = 1$

8. $\frac{2}{3}|5 - 2x| - \frac{1}{2} = 5$

9. $|x| = x + 3$

10. $|2x - 1| = x + 1$

11. $4 - |x| = 2x + 1$

12. $|x - 4| = x - 5$

13. $|x| = x^2$

14. $|x| = 12 - x^2$

15. $|x^2 - 1| = 3$

Prove that if $|f(x)| = |g(x)|$ then either $f(x) = g(x)$ or $f(x) = -g(x)$. Use that result to solve the equations in Exercises 16 - 21.

16. $|3x - 2| = |2x + 7|$

17. $|3x + 1| = |4x|$

18. $|1 - 2x| = |x + 1|$

19. $|4 - x| - |x + 2| = 0$

20. $|2 - 5x| = 5|x + 1|$

21. $3|x - 1| = 2|x + 1|$

In Exercises 22 - 33, graph the function. Find the zeros of each function and the x - and y -intercepts of each graph, if any exist. From the graph, determine the domain and range of each function, list the intervals on which the function is increasing, decreasing or constant, and find the relative and absolute extrema, if they exist.

22. $f(x) = |x + 4|$

23. $f(x) = |x| + 4$

24. $f(x) = |4x|$

25. $f(x) = -3|x|$

26. $f(x) = 3|x + 4| - 4$

27. $f(x) = \frac{1}{3}|2x - 1|$

28. $f(x) = \frac{|x + 4|}{x + 4}$

29. $f(x) = \frac{|2 - x|}{2 - x}$

30. $f(x) = x + |x| - 3$

31. $f(x) = |x + 2| - x$

32. $f(x) = |x + 2| - |x|$

33. $f(x) = |x + 4| + |x - 2|$

34. With the help of your classmates, find an absolute value function whose graph is given below.

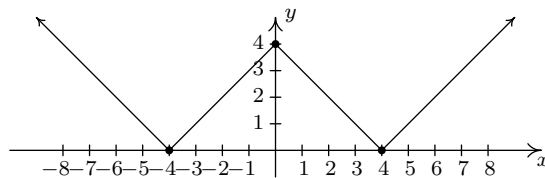

35. With help from your classmates, prove the second, third and fifth parts of Theorem 2.1.

36. Prove **The Triangle Inequality**: For all real numbers a and b , $|a + b| \leq |a| + |b|$.

2.2.2 ANSWERS

- | | | |
|--------------------------------|--|----------------------------------|
| 1. $x = -6$ or $x = 6$ | 2. $x = -3$ or $x = \frac{11}{3}$ | 3. $x = -3$ or $x = 11$ |
| 4. $x = -1$ or $x = 1$ | 5. $x = -\frac{1}{2}$ or $x = \frac{1}{10}$ | 6. no solution |
| 7. $x = -3$ or $x = 3$ | 8. $x = -\frac{13}{8}$ or $x = \frac{53}{8}$ | 9. $x = -\frac{3}{2}$ |
| 10. $x = 0$ or $x = 2$ | 11. $x = 1$ | 12. no solution |
| 13. $x = -1, x = 0$ or $x = 1$ | 14. $x = -3$ or $x = 3$ | 15. $x = -2$ or $x = 2$ |
| 16. $x = -1$ or $x = 9$ | 17. $x = -\frac{1}{7}$ or $x = 1$ | 18. $x = 0$ or $x = 2$ |
| 19. $x = 1$ | 20. $x = -\frac{3}{10}$ | 21. $x = \frac{1}{5}$ or $x = 5$ |

22. $f(x) = |x + 4|$
 $f(-4) = 0$
 x -intercept $(-4, 0)$
 y -intercept $(0, 4)$
 Domain $(-\infty, \infty)$
 Range $[0, \infty)$
 Decreasing on $(-\infty, -4]$
 Increasing on $[-4, \infty)$
 Relative and absolute min. at $(-4, 0)$
 No relative or absolute maximum

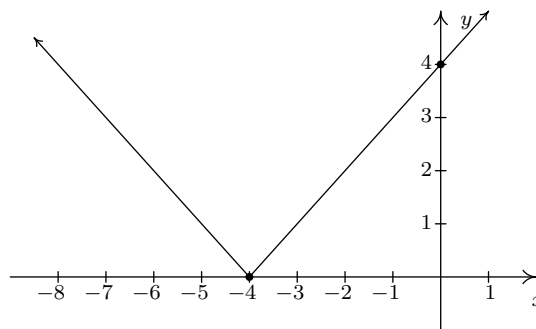

23. $f(x) = |x| + 4$
 No zeros
 No x -intercepts
 y -intercept $(0, 4)$
 Domain $(-\infty, \infty)$
 Range $[4, \infty)$
 Decreasing on $(-\infty, 0]$
 Increasing on $[0, \infty)$
 Relative and absolute minimum at $(0, 4)$
 No relative or absolute maximum

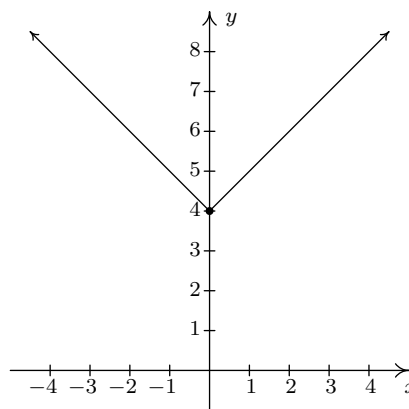

24. $f(x) = |4x|$
 $f(0) = 0$
 x -intercept $(0, 0)$
 y -intercept $(0, 0)$
Domain $(-\infty, \infty)$
Range $[0, \infty)$
Decreasing on $(-\infty, 0]$
Increasing on $[0, \infty)$
Relative and absolute minimum at $(0, 0)$
No relative or absolute maximum

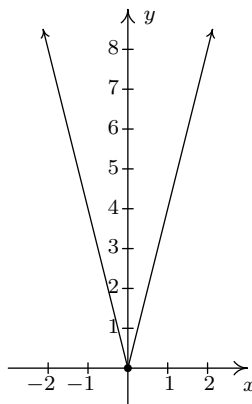

25. $f(x) = -3|x|$
 $f(0) = 0$
 x -intercept $(0, 0)$
 y -intercept $(0, 0)$
Domain $(-\infty, \infty)$
Range $(-\infty, 0]$
Increasing on $(-\infty, 0]$
Decreasing on $[0, \infty)$
Relative and absolute maximum at $(0, 0)$
No relative or absolute minimum

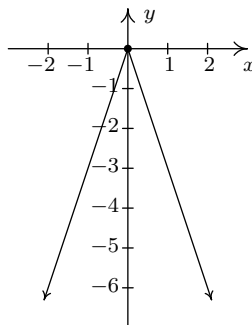

26. $f(x) = 3|x + 4| - 4$
 $f(-\frac{16}{3}) = 0$, $f(-\frac{8}{3}) = 0$
 x -intercepts $(-\frac{16}{3}, 0)$, $(-\frac{8}{3}, 0)$
 y -intercept $(0, 8)$
Domain $(-\infty, \infty)$
Range $[-4, \infty)$
Decreasing on $(-\infty, -4]$
Increasing on $[-4, \infty)$
Relative and absolute min. at $(-4, -4)$
No relative or absolute maximum

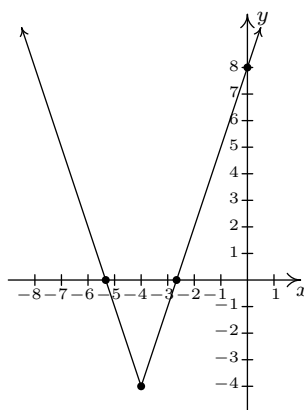

27. $f(x) = \frac{1}{3}|2x - 1|$
 $f(\frac{1}{2}) = 0$
 x -intercepts $(\frac{1}{2}, 0)$
 y -intercept $(0, \frac{1}{3})$
Domain $(-\infty, \infty)$
Range $[0, \infty)$
Decreasing on $(-\infty, \frac{1}{2}]$
Increasing on $[\frac{1}{2}, \infty)$

Relative and absolute min. at $(\frac{1}{2}, 0)$
No relative or absolute maximum

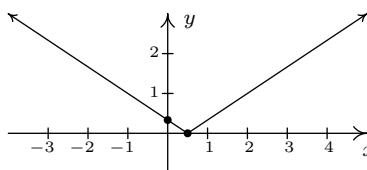

28. $f(x) = \frac{|x+4|}{x+4}$

No zeros

No x -intercept

y -intercept $(0, 1)$

Domain $(-\infty, -4) \cup (-4, \infty)$

Range $\{-1, 1\}$

Constant on $(-\infty, -4)$

Constant on $(-4, \infty)$

Absolute minimum at every point $(x, -1)$

where $x < -4$

Absolute maximum at every point $(x, 1)$
where $x > -4$

Relative maximum AND minimum at every
point on the graph

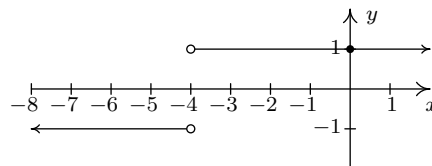

29. $f(x) = \frac{|2-x|}{2-x}$

No zeros

No x -intercept

y -intercept $(0, 1)$

Domain $(-\infty, 2) \cup (2, \infty)$

Range $\{-1, 1\}$

Constant on $(-\infty, 2)$

Constant on $(2, \infty)$

Absolute minimum at every point $(x, -1)$

where $x > 2$

Absolute maximum at every point $(x, 1)$
where $x < 2$

Relative maximum AND minimum at every
point on the graph

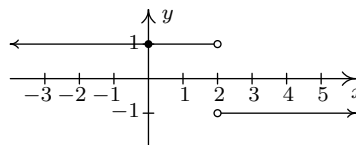

30. Re-write $f(x) = x + |x| - 3$ as

$$f(x) = \begin{cases} -3 & \text{if } x < 0 \\ 2x - 3 & \text{if } x \geq 0 \end{cases}$$

$$f\left(\frac{3}{2}\right) = 0$$

x -intercept $(\frac{3}{2}, 0)$

y -intercept $(0, -3)$

Domain $(-\infty, \infty)$

Range $[-3, \infty)$

Increasing on $[0, \infty)$

Constant on $(-\infty, 0]$

Absolute minimum at every point $(x, -3)$
where $x \leq 0$

No absolute maximum

Relative minimum at every point $(x, -3)$
where $x \leq 0$

Relative maximum at every point $(x, -3)$
where $x < 0$

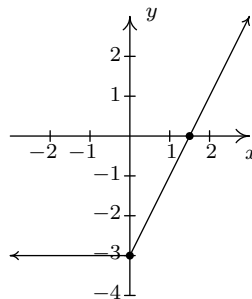

31. Re-write
- $f(x) = |x + 2| - x$
- as

$$f(x) = \begin{cases} -2x - 2 & \text{if } x < -2 \\ 2 & \text{if } x \geq -2 \end{cases}$$

No zeros

No x -intercepts y -intercept $(0, 2)$ Domain $(-\infty, \infty)$ Range $[2, \infty)$ Decreasing on $(-\infty, -2]$ Constant on $[-2, \infty)$ Absolute minimum at every point $(x, 2)$ where $x \geq -2$

No absolute maximum

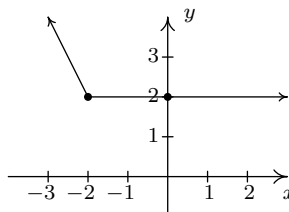
Relative minimum at every point $(x, 2)$ where $x \geq -2$ Relative maximum at every point $(x, 2)$ where $x < -2$ 

32. Re-write
- $f(x) = |x + 2| - |x|$
- as

$$f(x) = \begin{cases} -2 & \text{if } x < -2 \\ 2x + 2 & \text{if } -2 \leq x < 0 \\ 2 & \text{if } x \geq 0 \end{cases}$$

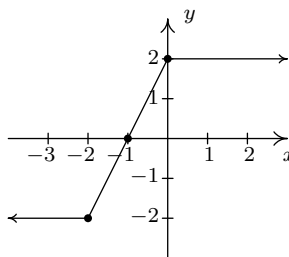
 $f(-1) = 0$ x -intercept $(-1, 0)$ y -intercept $(0, 2)$ Domain $(-\infty, \infty)$ Range $[-2, 2]$ Increasing on $[-2, 0]$ Constant on $(-\infty, -2]$ Constant on $[0, \infty)$ Absolute minimum at every point $(x, -2)$ where $x \leq -2$ Absolute maximum at every point $(x, 2)$ where $x \geq 0$ Relative minimum at every point $(x, -2)$ where $x \leq -2$ and at every point $(x, 2)$ where $x > 0$ Relative maximum at every point $(x, -2)$ where $x < -2$ and at every point $(x, 2)$ where $x \geq 0$ 

33. Re-write
- $f(x) = |x + 4| + |x - 2|$
- as

$$f(x) = \begin{cases} -2x - 2 & \text{if } x < -4 \\ 6 & \text{if } -4 \leq x < 2 \\ 2x + 2 & \text{if } x \geq 2 \end{cases}$$

No zeros

No x -intercept y -intercept $(0, 6)$ Domain $(-\infty, \infty)$ Range $[6, \infty)$ Decreasing on $(-\infty, -4]$ Constant on $[-4, 2]$ Increasing on $[2, \infty)$ Absolute minimum at every point $(x, 6)$ where $-4 \leq x \leq 2$

No absolute maximum

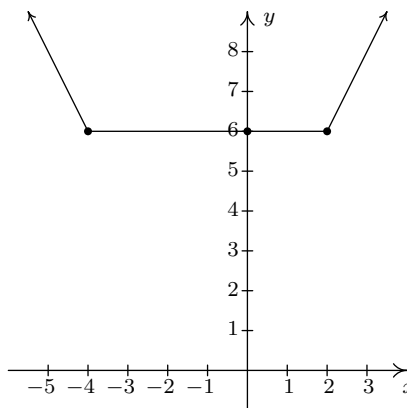
Relative minimum at every point $(x, 6)$ where $-4 \leq x \leq 2$ Relative maximum at every point $(x, 6)$ where $-4 < x < 2$ 

- 35.
- $f(x) = ||x| - 4|$

2.3 QUADRATIC FUNCTIONS

You may recall studying quadratic equations in Intermediate Algebra. In this section, we review those equations in the context of our next family of functions: the quadratic functions.

Definition 2.5. A **quadratic function** is a function of the form

$$f(x) = ax^2 + bx + c,$$

where a , b and c are real numbers with $a \neq 0$. The domain of a quadratic function is $(-\infty, \infty)$.

The most basic quadratic function is $f(x) = x^2$, whose graph appears below. Its shape should look familiar from Intermediate Algebra – it is called a **parabola**. The point $(0, 0)$ is called the **vertex** of the parabola. In this case, the vertex is a relative minimum and is also the where the absolute minimum value of f can be found.

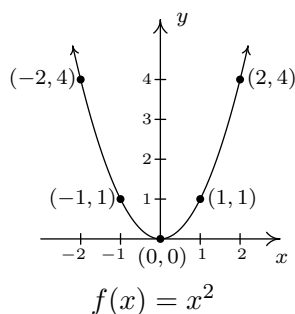

Much like many of the absolute value functions in Section 2.2, knowing the graph of $f(x) = x^2$ enables us to graph an entire family of quadratic functions using transformations.

Example 2.3.1. Graph the following functions starting with the graph of $f(x) = x^2$ and using transformations. Find the vertex, state the range and find the x - and y -intercepts, if any exist.

1. $g(x) = (x + 2)^2 - 3$

2. $h(x) = -2(x - 3)^2 + 1$

Solution.

- Since $g(x) = (x + 2)^2 - 3 = f(x + 2) - 3$, Theorem 1.7 instructs us to first *subtract* 2 from each of the x -values of the points on $y = f(x)$. This shifts the graph of $y = f(x)$ to the *left* 2 units and moves $(-2, 4)$ to $(-4, 4)$, $(-1, 1)$ to $(-3, 1)$, $(0, 0)$ to $(-2, 0)$, $(1, 1)$ to $(-1, 1)$ and $(2, 4)$ to $(0, 4)$. Next, we *subtract* 3 from each of the y -values of these new points. This moves the graph *down* 3 units and moves $(-4, 4)$ to $(-4, 1)$, $(-3, 1)$ to $(-3, -2)$, $(-2, 0)$ to $(-2, -3)$, $(-1, 1)$ to $(-1, -2)$ and $(0, 4)$ to $(0, 1)$. We connect the dots in parabolic fashion to get

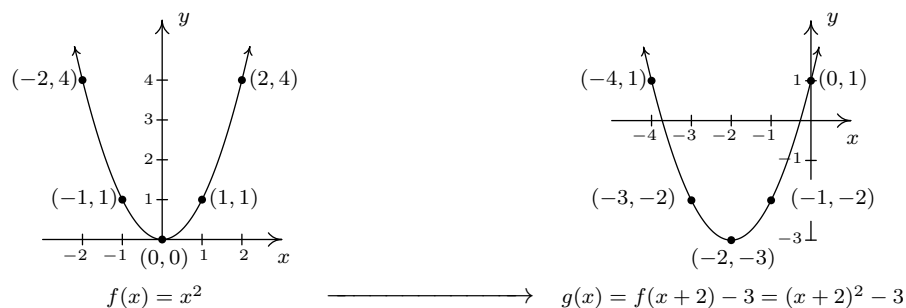

From the graph, we see that the vertex has moved from $(0, 0)$ on the graph of $y = f(x)$ to $(-2, -3)$ on the graph of $y = g(x)$. This sets $[-3, \infty)$ as the range of g . We see that the graph of $y = g(x)$ crosses the x -axis twice, so we expect two x -intercepts. To find these, we set $y = g(x) = 0$ and solve. Doing so yields the equation $(x+2)^2 - 3 = 0$, or $(x+2)^2 = 3$. Extracting square roots gives $x+2 = \pm\sqrt{3}$, or $x = -2 \pm \sqrt{3}$. Our x -intercepts are $(-2 - \sqrt{3}, 0) \approx (-3.73, 0)$ and $(-2 + \sqrt{3}, 0) \approx (-0.27, 0)$. The y -intercept of the graph, $(0, 1)$ was one of the points we originally plotted, so we are done.

2. Following Theorem 1.7 once more, to graph $h(x) = -2(x-3)^2 + 1 = -2f(x-3) + 1$, we first start by *adding 3* to each of the x -values of the points on the graph of $y = f(x)$. This effects a horizontal shift *right* 3 units and moves $(-2, 4)$ to $(1, 4)$, $(-1, 1)$ to $(2, 1)$, $(0, 0)$ to $(3, 0)$, $(1, 1)$ to $(4, 1)$ and $(2, 4)$ to $(5, 4)$. Next, we *multiply* each of our y -values first by -2 and then *add 1* to that result. Geometrically, this is a vertical *stretch* by a factor of 2, followed by a reflection about the x -axis, followed by a vertical shift *up* 1 unit. This moves $(1, 4)$ to $(1, -7)$, $(2, 1)$ to $(2, -1)$, $(3, 0)$ to $(3, 1)$, $(4, 1)$ to $(4, -1)$ and $(5, 4)$ to $(5, -7)$.

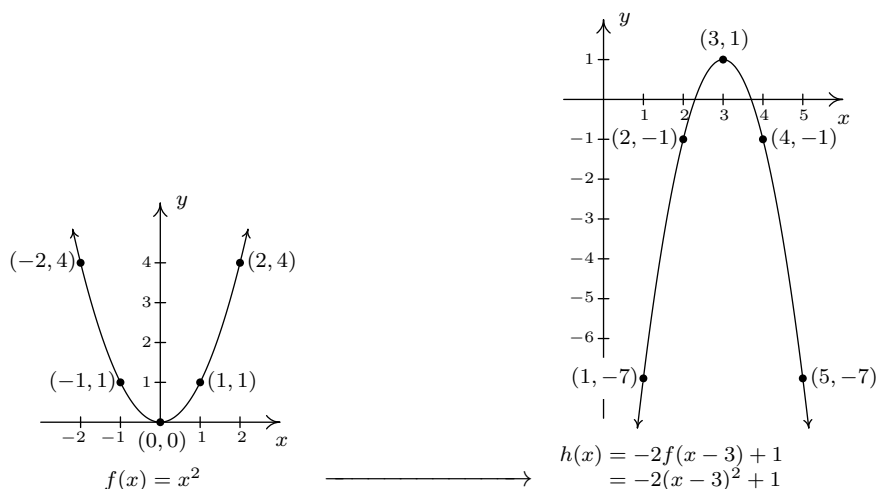

The vertex is $(3, 1)$ which makes the range of h $(-\infty, 1]$. From our graph, we know that there are two x -intercepts, so we set $y = h(x) = 0$ and solve. We get $-2(x-3)^2 + 1 = 0$

which gives $(x - 3)^2 = \frac{1}{2}$. Extracting square roots¹ gives $x - 3 = \pm \frac{\sqrt{2}}{2}$, so that when we add 3 to each side,² we get $x = \frac{6 \pm \sqrt{2}}{2}$. Hence, our x -intercepts are $\left(\frac{6 - \sqrt{2}}{2}, 0\right) \approx (2.29, 0)$ and $\left(\frac{6 + \sqrt{2}}{2}, 0\right) \approx (3.71, 0)$. Although our graph doesn't show it, there is a y -intercept which can be found by setting $x = 0$. With $h(0) = -2(0 - 3)^2 + 1 = -17$, we have that our y -intercept is $(0, -17)$. \square

A few remarks about Example 2.3.1 are in order. First note that neither the formula given for $g(x)$ nor the one given for $h(x)$ match the form given in Definition 2.5. We could, of course, convert both $g(x)$ and $h(x)$ into that form by expanding and collecting like terms. Doing so, we find $g(x) = (x + 2)^2 - 3 = x^2 + 4x + 1$ and $h(x) = -2(x - 3)^2 + 1 = -2x^2 + 12x - 17$. While these 'simplified' formulas for $g(x)$ and $h(x)$ satisfy Definition 2.5, they do not lend themselves to graphing easily. For that reason, the form of g and h presented in Example 2.3.2 is given a special name, which we list below, along with the form presented in Definition 2.5.

Definition 2.6. Standard and General Form of Quadratic Functions: Suppose f is a quadratic function.

- The **general form** of the quadratic function f is $f(x) = ax^2 + bx + c$, where a , b and c are real numbers with $a \neq 0$.
- The **standard form** of the quadratic function f is $f(x) = a(x - h)^2 + k$, where a , h and k are real numbers with $a \neq 0$.

It is important to note at this stage that we have no guarantees that *every* quadratic function can be written in standard form. This is actually true, and we prove this later in the exposition, but for now we celebrate the advantages of the standard form, starting with the following theorem.

Theorem 2.2. Vertex Formula for Quadratics in Standard Form: For the quadratic function $f(x) = a(x - h)^2 + k$, where a , h and k are real numbers with $a \neq 0$, the vertex of the graph of $y = f(x)$ is (h, k) .

We can readily verify the formula given Theorem 2.2 with the two functions given in Example 2.3.1. After a (slight) rewrite, $g(x) = (x + 2)^2 - 3 = (x - (-2))^2 + (-3)$, and we identify $h = -2$ and $k = -3$. Sure enough, we found the vertex of the graph of $y = g(x)$ to be $(-2, -3)$. For $h(x) = -2(x - 3)^2 + 1$, no rewrite is needed. We can directly identify $h = 3$ and $k = 1$ and, sure enough, we found the vertex of the graph of $y = h(x)$ to be $(3, 1)$.

To see why the formula in Theorem 2.2 produces the vertex, consider the graph of the equation $y = a(x - h)^2 + k$. When we substitute $x = h$, we get $y = k$, so (h, k) is on the graph. If $x \neq h$, then $x - h \neq 0$ so $(x - h)^2$ is a positive number. If $a > 0$, then $a(x - h)^2$ is positive, thus $y = a(x - h)^2 + k$ is always a number larger than k . This means that when $a > 0$, (h, k) is the lowest point on the graph and thus the parabola must open upwards, making (h, k) the vertex. A similar argument

¹and rationalizing denominators!

²and get common denominators!

shows that if $a < 0$, (h, k) is the highest point on the graph, so the parabola opens downwards, and (h, k) is also the vertex in this case.

Alternatively, we can apply the machinery in Section 1.7. Since the vertex of $y = x^2$ is $(0, 0)$, we can determine the vertex of $y = a(x - h)^2 + k$ by determining the final destination of $(0, 0)$ as it is moved through each transformation. To obtain the formula $f(x) = a(x - h)^2 + k$, we start with $g(x) = x^2$ and first define $g_1(x) = ag(x) = ax^2$. This results in a vertical scaling and/or reflection.³ Since we multiply the output by a , we multiply the y -coordinates on the graph of g by a , so the point $(0, 0)$ remains $(0, 0)$ and remains the vertex. Next, we define $g_2(x) = g_1(x - h) = a(x - h)^2$. This induces a horizontal shift right or left h units⁴ moves the vertex, in either case, to $(h, 0)$. Finally, $f(x) = g_2(x) + k = a(x - h)^2 + k$ which effects a vertical shift up or down k units⁵ resulting in the vertex moving from $(h, 0)$ to (h, k) .

In addition to verifying Theorem 2.2, the arguments in the two preceding paragraphs have also shown us the role of the number a in the graphs of quadratic functions. The graph of $y = a(x - h)^2 + k$ is a parabola ‘opening upwards’ if $a > 0$, and ‘opening downwards’ if $a < 0$. Moreover, the symmetry enjoyed by the graph of $y = x^2$ about the y -axis is translated to a symmetry about the vertical line $x = h$ which is the vertical line through the vertex.⁶ This line is called the **axis of symmetry** of the parabola and is dashed in the figures below.



Graphs of $y = a(x - h)^2 + k$.

Without a doubt, the standard form of a quadratic function, coupled with the machinery in Section 1.7, allows us to list the attributes of the graphs of such functions quickly and elegantly. What remains to be shown, however, is the fact that every quadratic function *can be written* in standard form. To convert a quadratic function given in general form into standard form, we employ the ancient rite of ‘Completing the Square’. We remind the reader how this is done in our next example.

Example 2.3.2. Convert the functions below from general form to standard form. Find the vertex, axis of symmetry and any x - or y -intercepts. Graph each function and determine its range.

1. $f(x) = x^2 - 4x + 3$.

2. $g(x) = 6 - x - x^2$

³Just a scaling if $a > 0$. If $a < 0$, there is a reflection involved.

⁴Right if $h > 0$, left if $h < 0$.

⁵Up if $k > 0$, down if $k < 0$

⁶You should use transformations to verify this!

Solution.

1. To convert from general form to standard form, we complete the square.⁷ First, we verify that the coefficient of x^2 is 1. Next, we find the coefficient of x , in this case -4 , and take half of it to get $\frac{1}{2}(-4) = -2$. This tells us that our target perfect square quantity is $(x - 2)^2$. To get an expression equivalent to $(x - 2)^2$, we need to add $(-2)^2 = 4$ to the $x^2 - 4x$ to create a perfect square trinomial, but to keep the balance, we must also subtract it. We collect the terms which create the perfect square and gather the remaining constant terms. Putting it all together, we get

$$\begin{aligned} f(x) &= x^2 - 4x + 3 && \text{(Compute } \frac{1}{2}(-4) = -2.\text{)} \\ &= (x^2 - 4x + \underline{4} - \underline{4}) + 3 && \text{(Add and subtract } (-2)^2 = 4 \text{ to } (x^2 - 4x).\text{)} \\ &= (x^2 - 4x + 4) - 4 + 3 && \text{(Group the perfect square trinomial.)} \\ &= (x - 2)^2 - 1 && \text{(Factor the perfect square trinomial.)} \end{aligned}$$

Of course, we can always check our answer by multiplying out $f(x) = (x - 2)^2 - 1$ to see that it simplifies to $f(x) = x^2 - 4x - 1$. In the form $f(x) = (x - 2)^2 - 1$, we readily find the vertex to be $(2, -1)$ which makes the axis of symmetry $x = 2$. To find the x -intercepts, we set $y = f(x) = 0$. We are spoiled for choice, since we have *two* formulas for $f(x)$. Since we recognize $f(x) = x^2 - 4x + 3$ to be easily factorable,⁸ we proceed to solve $x^2 - 4x + 3 = 0$. Factoring gives $(x - 3)(x - 1) = 0$ so that $x = 3$ or $x = 1$. The x -intercepts are then $(1, 0)$ and $(3, 0)$. To find the y -intercept, we set $x = 0$. Once again, the general form $f(x) = x^2 - 4x + 3$ is easiest to work with here, and we find $y = f(0) = 3$. Hence, the y -intercept is $(0, 3)$. With the vertex, axis of symmetry and the intercepts, we get a pretty good graph without the need to plot additional points. We see that the range of f is $[-1, \infty)$ and we are done.

2. To get started, we rewrite $g(x) = 6 - x - x^2 = -x^2 - x + 6$ and note that the coefficient of x^2 is -1 , not 1. This means our first step is to factor out the (-1) from both the x^2 and x terms. We then follow the completing the square recipe as above.

$$\begin{aligned} g(x) &= -x^2 - x + 6 \\ &= (-1)(x^2 + x) + 6 && \text{(Factor the coefficient of } x^2 \text{ from } x^2 \text{ and } x.\text{)} \\ &= (-1)\left(x^2 + x + \frac{1}{4} - \frac{1}{4}\right) + 6 \\ &= (-1)\left(x^2 + x + \frac{1}{4}\right) + (-1)\left(-\frac{1}{4}\right) + 6 && \text{(Group the perfect square trinomial.)} \\ &= -\left(x + \frac{1}{2}\right)^2 + \frac{25}{4} \end{aligned}$$

⁷If you forget why we do what we do to complete the square, start with $a(x - h)^2 + k$, multiply it out, step by step, and then reverse the process.

⁸Experience pays off, here!

From $g(x) = -\left(x + \frac{1}{2}\right)^2 + \frac{25}{4}$, we get the vertex to be $\left(-\frac{1}{2}, \frac{25}{4}\right)$ and the axis of symmetry to be $x = -\frac{1}{2}$. To get the x -intercepts, we opt to set the given formula $g(x) = 6 - x - x^2 = 0$. Solving, we get $x = -3$ and $x = 2$, so the x -intercepts are $(-3, 0)$ and $(2, 0)$. Setting $x = 0$, we find $g(0) = 6$, so the y -intercept is $(0, 6)$. Plotting these points gives us the graph below. We see that the range of g is $(-\infty, \frac{25}{4}]$.

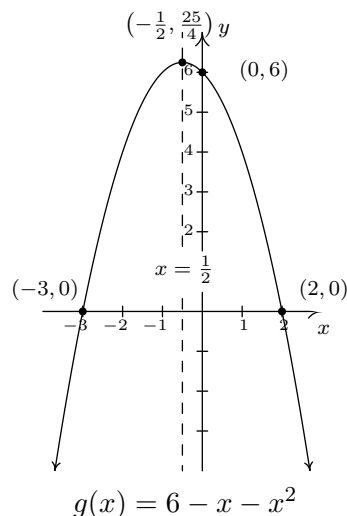
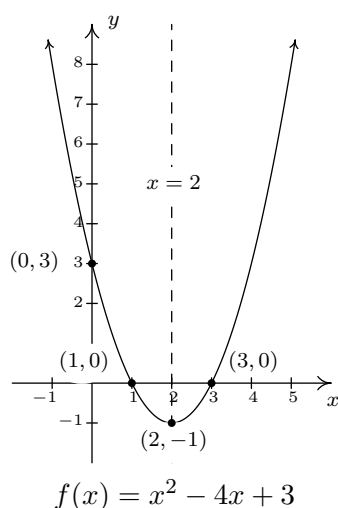

□

With Example 2.3.2 fresh in our minds, we are now in a position to show that every quadratic function can be written in standard form. We begin with $f(x) = ax^2 + bx + c$, assume $a \neq 0$, and complete the square in *complete* generality.

$$\begin{aligned}
 f(x) &= ax^2 + bx + c \\
 &= a\left(x^2 + \frac{b}{a}x\right) + c && \text{(Factor out coefficient of } x^2 \text{ from } x^2 \text{ and } x.) \\
 &= a\left(x^2 + \frac{b}{a}x + \frac{b^2}{4a^2} - \frac{b^2}{4a^2}\right) + c \\
 &= a\left(x^2 + \frac{b}{a}x + \frac{b^2}{4a^2}\right) - a\left(\frac{b^2}{4a^2}\right) + c && \text{(Group the perfect square trinomial.)} \\
 &= a\left(x + \frac{b}{2a}\right)^2 + \frac{4ac - b^2}{4a} && \text{(Factor and get a common denominator.)}
 \end{aligned}$$

Comparing this last expression with the standard form, we identify $(x - h)$ with $\left(x + \frac{b}{2a}\right)$ so that $h = -\frac{b}{2a}$. Instead of memorizing the value $k = \frac{4ac - b^2}{4a}$, we see that $f\left(-\frac{b}{2a}\right) = \frac{4ac - b^2}{4a}$. As such, we have derived a vertex formula for the general form. We summarize both vertex formulas in the box at the top of the next page.

Equation 2.4. Vertex Formulas for Quadratic Functions: Suppose a , b , c , h and k are real numbers with $a \neq 0$.

- If $f(x) = a(x - h)^2 + k$, the vertex of the graph of $y = f(x)$ is the point (h, k) .
- If $f(x) = ax^2 + bx + c$, the vertex of the graph of $y = f(x)$ is the point $\left(-\frac{b}{2a}, f\left(-\frac{b}{2a}\right)\right)$.

There are two more results which can be gleaned from the completed-square form of the general form of a quadratic function,

$$f(x) = ax^2 + bx + c = a\left(x + \frac{b}{2a}\right)^2 + \frac{4ac - b^2}{4a}$$

We have seen that the number a in the standard form of a quadratic function determines whether the parabola opens upwards (if $a > 0$) or downwards (if $a < 0$). We see here that this number a is none other than the coefficient of x^2 in the general form of the quadratic function. In other words, it is the coefficient of x^2 alone which determines this behavior – a result that is generalized in Section 3.1. The second treasure is a re-discovery of the **quadratic formula**.

Equation 2.5. The Quadratic Formula: If a , b and c are real numbers with $a \neq 0$, then the solutions to $ax^2 + bx + c = 0$ are

$$x = \frac{-b \pm \sqrt{b^2 - 4ac}}{2a}.$$

Assuming the conditions of Equation 2.5, the solutions to $ax^2 + bx + c = 0$ are precisely the zeros of $f(x) = ax^2 + bx + c$. Since

$$f(x) = ax^2 + bx + c = a\left(x + \frac{b}{2a}\right)^2 + \frac{4ac - b^2}{4a}$$

the equation $ax^2 + bx + c = 0$ is equivalent to

$$a\left(x + \frac{b}{2a}\right)^2 + \frac{4ac - b^2}{4a} = 0.$$

Solving gives

$$\begin{aligned}
a \left(x + \frac{b}{2a} \right)^2 + \frac{4ac - b^2}{4a} &= 0 \\
a \left(x + \frac{b}{2a} \right)^2 &= -\frac{4ac - b^2}{4a} \\
\frac{1}{a} \left[a \left(x + \frac{b}{2a} \right)^2 \right] &= \frac{1}{a} \left(\frac{b^2 - 4ac}{4a} \right) \\
\left(x + \frac{b}{2a} \right)^2 &= \frac{b^2 - 4ac}{4a^2} \\
x + \frac{b}{2a} &= \pm \sqrt{\frac{b^2 - 4ac}{4a^2}} && \text{extract square roots} \\
x + \frac{b}{2a} &= \pm \frac{\sqrt{b^2 - 4ac}}{2a} \\
x &= -\frac{b}{2a} \pm \frac{\sqrt{b^2 - 4ac}}{2a} \\
x &= \frac{-b \pm \sqrt{b^2 - 4ac}}{2a}
\end{aligned}$$

In our discussions of domain, we were warned against having negative numbers underneath the square root. Given that $\sqrt{b^2 - 4ac}$ is part of the Quadratic Formula, we will need to pay special attention to the radicand $b^2 - 4ac$. It turns out that the quantity $b^2 - 4ac$ plays a critical role in determining the nature of the solutions to a quadratic equation. It is given a special name.

Definition 2.7. If a , b and c are real numbers with $a \neq 0$, then the **discriminant** of the quadratic equation $ax^2 + bx + c = 0$ is the quantity $b^2 - 4ac$.

The discriminant ‘discriminates’ between the kinds of solutions we get from a quadratic equation. These cases, and their relation to the discriminant, are summarized below.

Theorem 2.3. Discriminant Trichotomy: Let a , b and c be real numbers with $a \neq 0$.

- If $b^2 - 4ac < 0$, the equation $ax^2 + bx + c = 0$ has no real solutions.
- If $b^2 - 4ac = 0$, the equation $ax^2 + bx + c = 0$ has exactly one real solution.
- If $b^2 - 4ac > 0$, the equation $ax^2 + bx + c = 0$ has exactly two real solutions.

The proof of Theorem 2.3 stems from the position of the discriminant in the quadratic equation, and is left as a good mental exercise for the reader. The next example exploits the fruits of all of our labor in this section thus far.

Example 2.3.3. Recall that the profit (defined on page 216) for a product is defined by the equation Profit = Revenue – Cost, or $P(x) = R(x) - C(x)$. In Example 2.1.7 the weekly revenue, in dollars, made by selling x PortaBoy Game Systems was found to be $R(x) = -1.5x^2 + 250x$ with the restriction (carried over from the price-demand function) that $0 \leq x \leq 166$. The cost, in dollars, to produce x PortaBoy Game Systems is given in Example 2.1.5 as $C(x) = 80x + 150$ for $x \geq 0$.

1. Determine the weekly profit function $P(x)$.
2. Graph $y = P(x)$. Include the x - and y -intercepts as well as the vertex and axis of symmetry.
3. Interpret the zeros of P .
4. Interpret the vertex of the graph of $y = P(x)$.
5. Recall that the weekly price-demand equation for PortaBoys is $p(x) = -1.5x + 250$, where $p(x)$ is the price per PortaBoy, in dollars, and x is the weekly sales. What should the price per system be in order to maximize profit?

Solution.

1. To find the profit function $P(x)$, we subtract

$$P(x) = R(x) - C(x) = (-1.5x^2 + 250x) - (80x + 150) = -1.5x^2 + 170x - 150.$$

Since the revenue function is valid when $0 \leq x \leq 166$, P is also restricted to these values.

2. To find the x -intercepts, we set $P(x) = 0$ and solve $-1.5x^2 + 170x - 150 = 0$. The mere thought of trying to factor the left hand side of this equation could do serious psychological damage, so we resort to the quadratic formula, Equation 2.5. Identifying $a = -1.5$, $b = 170$, and $c = -150$, we obtain

$$\begin{aligned} x &= \frac{-b \pm \sqrt{b^2 - 4ac}}{2a} \\ &= \frac{-170 \pm \sqrt{170^2 - 4(-1.5)(-150)}}{2(-1.5)} \\ &= \frac{-170 \pm \sqrt{28000}}{-3} \\ &= \frac{170 \pm 20\sqrt{70}}{3} \end{aligned}$$

We get two x -intercepts: $\left(\frac{170-20\sqrt{70}}{3}, 0\right)$ and $\left(\frac{170+20\sqrt{70}}{3}, 0\right)$. To find the y -intercept, we set $x = 0$ and find $y = P(0) = -150$ for a y -intercept of $(0, -150)$. To find the vertex, we use the fact that $P(x) = -1.5x^2 + 170x - 150$ is in the general form of a quadratic function and appeal to Equation 2.4. Substituting $a = -1.5$ and $b = 170$, we get $x = -\frac{170}{2(-1.5)} = \frac{170}{3}$.

To find the y -coordinate of the vertex, we compute $P\left(\frac{170}{3}\right) = \frac{14000}{3}$ and find that our vertex is $\left(\frac{170}{3}, \frac{14000}{3}\right)$. The axis of symmetry is the vertical line passing through the vertex so it is the line $x = \frac{170}{3}$. To sketch a reasonable graph, we approximate the x -intercepts, $(0.89, 0)$ and $(112.44, 0)$, and the vertex, $(56.67, 4666.67)$. (Note that in order to get the x -intercepts and the vertex to show up in the same picture, we had to scale the x -axis differently than the y -axis. This results in the left-hand x -intercept and the y -intercept being uncomfortably close to each other and to the origin in the picture.)

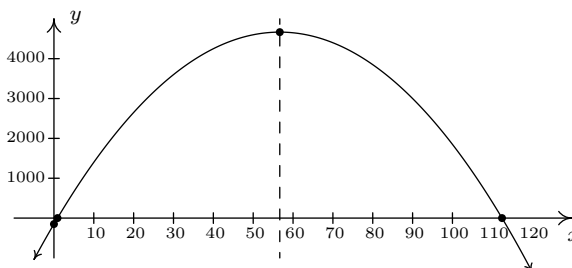

3. The zeros of P are the solutions to $P(x) = 0$, which we have found to be approximately 0.89 and 112.44. As we saw in Example 1.5.3, these are the ‘break-even’ points of the profit function, where enough product is sold to recover the cost spent to make the product. More importantly, we see from the graph that as long as x is between 0.89 and 112.44, the graph $y = P(x)$ is above the x -axis, meaning $y = P(x) > 0$ there. This means that for these values of x , a profit is being made. Since x represents the weekly sales of PortaBoy Game Systems, we round the zeros to positive integers and have that as long as 1, but no more than 112 game systems are sold weekly, the retailer will make a profit.
4. From the graph, we see that the maximum value of P occurs at the vertex, which is approximately $(56.67, 4666.67)$. As above, x represents the weekly sales of PortaBoy systems, so we can’t sell 56.67 game systems. Comparing $P(56) = 4666$ and $P(57) = 4666.5$, we conclude that we will make a maximum profit of \$4666.50 if we sell 57 game systems.
5. In the previous part, we found that we need to sell 57 PortaBoys per week to maximize profit. To find the price per PortaBoy, we substitute $x = 57$ into the price-demand function to get $p(57) = -1.5(57) + 250 = 164.5$. The price should be set at \$164.50. \square

Our next example is another classic application of quadratic functions.

Example 2.3.4. Much to Donnie’s surprise and delight, he inherits a large parcel of land in Ashtabula County from one of his (e)strange(d) relatives. The time is finally right for him to pursue his dream of farming alpaca. He wishes to build a rectangular pasture, and estimates that he has enough money for 200 linear feet of fencing material. If he makes the pasture adjacent to a stream (so no fencing is required on that side), what are the dimensions of the pasture which maximize the area? What is the maximum area? If an average alpaca needs 25 square feet of grazing area, how many alpaca can Donnie keep in his pasture?

Solution. It is always helpful to sketch the problem situation, so we do so below.

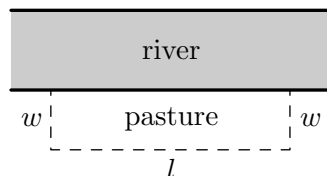

We are tasked to find the dimensions of the pasture which would give a maximum area. We let w denote the width of the pasture and we let l denote the length of the pasture. Since the units given to us in the statement of the problem are feet, we assume w and l are measured in feet. The area of the pasture, which we'll call A , is related to w and l by the equation $A = wl$. Since w and l are both measured in feet, A has units of feet², or square feet. We are given the total amount of fencing available is 200 feet, which means $w + l + w = 200$, or, $l + 2w = 200$. We now have two equations, $A = wl$ and $l + 2w = 200$. In order to use the tools given to us in this section to *maximize* A , we need to use the information given to write A as a function of just *one* variable, either w or l . This is where we use the equation $l + 2w = 200$. Solving for l , we find $l = 200 - 2w$, and we substitute this into our equation for A . We get $A = wl = w(200 - 2w) = 200w - 2w^2$. We now have A as a function of w , $A(w) = 200w - 2w^2 = -2w^2 + 200w$.

Before we go any further, we need to find the applied domain of A so that we know what values of w make sense in this problem situation.⁹ Since w represents the width of the pasture, $w > 0$. Likewise, l represents the length of the pasture, so $l = 200 - 2w > 0$. Solving this latter inequality, we find $w < 100$. Hence, the function we wish to maximize is $A(w) = -2w^2 + 200w$ for $0 < w < 100$. Since A is a quadratic function (of w), we know that the graph of $y = A(w)$ is a parabola. Since the coefficient of w^2 is -2 , we know that this parabola opens downwards. This means that there is a maximum value to be found, and we know it occurs at the vertex. Using the vertex formula, we find $w = -\frac{200}{2(-2)} = 50$, and $A(50) = -2(50)^2 + 200(50) = 5000$. Since $w = 50$ lies in the applied domain, $0 < w < 100$, we have that the area of the pasture is maximized when the width is 50 feet. To find the length, we use $l = 200 - 2w$ and find $l = 200 - 2(50) = 100$, so the length of the pasture is 100 feet. The maximum area is $A(50) = 5000$, or 5000 square feet. If an average alpaca requires 25 square feet of pasture, Donnie can raise $\frac{5000}{25} = 200$ average alpaca. \square

We conclude this section with the graph of a more complicated absolute value function.

Example 2.3.5. Graph $f(x) = |x^2 - x - 6|$.

Solution. Using the definition of absolute value, Definition 2.4, we have

$$f(x) = \begin{cases} -(x^2 - x - 6), & \text{if } x^2 - x - 6 < 0 \\ x^2 - x - 6, & \text{if } x^2 - x - 6 \geq 0 \end{cases}$$

The trouble is that we have yet to develop any analytic techniques to solve nonlinear inequalities such as $x^2 - x - 6 < 0$. You won't have to wait long; this is one of the main topics of Section 2.4.

⁹Donnie would be very upset if, for example, we told him the width of the pasture needs to be -50 feet.

Nevertheless, we can attack this problem graphically. To that end, we graph $y = g(x) = x^2 - x - 6$ using the intercepts and the vertex. To find the x -intercepts, we solve $x^2 - x - 6 = 0$. Factoring gives $(x - 3)(x + 2) = 0$ so $x = -2$ or $x = 3$. Hence, $(-2, 0)$ and $(3, 0)$ are x -intercepts. The y -intercept $(0, -6)$ is found by setting $x = 0$. To plot the vertex, we find $x = -\frac{b}{2a} = -\frac{-1}{2(1)} = \frac{1}{2}$, and $y = \left(\frac{1}{2}\right)^2 - \left(\frac{1}{2}\right) - 6 = -\frac{25}{4} = -6.25$. Plotting, we get the parabola seen below on the left. To obtain points on the graph of $y = f(x) = |x^2 - x - 6|$, we can take points on the graph of $g(x) = x^2 - x - 6$ and apply the absolute value to each of the y values on the parabola. We see from the graph of g that for $x \leq -2$ or $x \geq 3$, the y values on the parabola are greater than or equal to zero (since the graph is on or above the x -axis), so the absolute value leaves these portions of the graph alone. For x between -2 and 3 , however, the y values on the parabola are negative. For example, the point $(0, -6)$ on $y = x^2 - x - 6$ would result in the point $(0, |-6|) = (0, -(-6)) = (0, 6)$ on the graph of $f(x) = |x^2 - x - 6|$. Proceeding in this manner for all points with x -coordinates between -2 and 3 results in the graph seen below on the right.

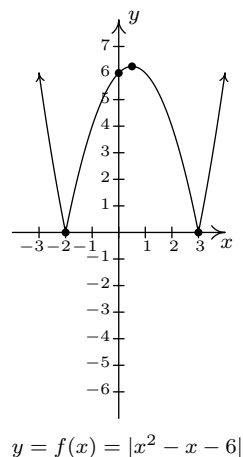
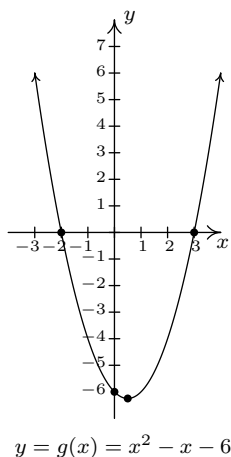

□

If we take a step back and look at the graphs of g and f in the last example, we notice that to obtain the graph of f from the graph of g , we reflect a *portion* of the graph of g about the x -axis. We can see this analytically by substituting $g(x) = x^2 - x - 6$ into the formula for $f(x)$ and calling to mind Theorem 1.4 from Section 1.7.

$$f(x) = \begin{cases} -g(x), & \text{if } g(x) < 0 \\ g(x), & \text{if } g(x) \geq 0 \end{cases}$$

The function f is defined so that when $g(x)$ is negative (i.e., when its graph is below the x -axis), the graph of f is its reflection across the x -axis. This is a general template to graph functions of the form $f(x) = |g(x)|$. From this perspective, the graph of $f(x) = |x|$ can be obtained by reflecting the portion of the line $g(x) = x$ which is below the x -axis back above the x -axis creating the characteristic ‘V’ shape.

2.3.1 EXERCISES

In Exercises 1 - 9, graph the quadratic function. Find the x - and y -intercepts of each graph, if any exist. If it is given in general form, convert it into standard form; if it is given in standard form, convert it into general form. Find the domain and range of the function and list the intervals on which the function is increasing or decreasing. Identify the vertex and the axis of symmetry and determine whether the vertex yields a relative and absolute maximum or minimum.

1. $f(x) = x^2 + 2$

2. $f(x) = -(x + 2)^2$

3. $f(x) = x^2 - 2x - 8$

4. $f(x) = -2(x + 1)^2 + 4$

5. $f(x) = 2x^2 - 4x - 1$

6. $f(x) = -3x^2 + 4x - 7$

7. $f(x) = x^2 + x + 1$

8. $f(x) = -3x^2 + 5x + 4$

9.¹⁰ $f(x) = x^2 - \frac{1}{100}x - 1$

In Exercises 10 - 14, the cost and price-demand functions are given for different scenarios. For each scenario,

- Find the profit function $P(x)$.
 - Find the number of items which need to be sold in order to maximize profit.
 - Find the maximum profit.
 - Find the price to charge per item in order to maximize profit.
 - Find and interpret break-even points.
10. The cost, in dollars, to produce x "I'd rather be a Sasquatch" T-Shirts is $C(x) = 2x + 26$, $x \geq 0$ and the price-demand function, in dollars per shirt, is $p(x) = 30 - 2x$, $0 \leq x \leq 15$.
 11. The cost, in dollars, to produce x bottles of 100% All-Natural Certified Free-Trade Organic Sasquatch Tonic is $C(x) = 10x + 100$, $x \geq 0$ and the price-demand function, in dollars per bottle, is $p(x) = 35 - x$, $0 \leq x \leq 35$.
 12. The cost, in cents, to produce x cups of Mountain Thunder Lemonade at Junior's Lemonade Stand is $C(x) = 18x + 240$, $x \geq 0$ and the price-demand function, in cents per cup, is $p(x) = 90 - 3x$, $0 \leq x \leq 30$.
 13. The daily cost, in dollars, to produce x Sasquatch Berry Pies is $C(x) = 3x + 36$, $x \geq 0$ and the price-demand function, in dollars per pie, is $p(x) = 12 - 0.5x$, $0 \leq x \leq 24$.
 14. The monthly cost, in *hundreds* of dollars, to produce x custom built electric scooters is $C(x) = 20x + 1000$, $x \geq 0$ and the price-demand function, in *hundreds* of dollars per scooter, is $p(x) = 140 - 2x$, $0 \leq x \leq 70$.

¹⁰We have already seen the graph of this function. It was used as an example in Section 1.6 to show how the graphing calculator can be misleading.

15. The International Silver Strings Submarine Band holds a bake sale each year to fund their trip to the National Sasquatch Convention. It has been determined that the cost in dollars of baking x cookies is $C(x) = 0.1x + 25$ and that the demand function for their cookies is $p = 10 - .01x$. How many cookies should they bake in order to maximize their profit?
16. Using data from [Bureau of Transportation Statistics](#), the average fuel economy F in miles per gallon for passenger cars in the US can be modeled by $F(t) = -0.0076t^2 + 0.45t + 16$, $0 \leq t \leq 28$, where t is the number of years since 1980. Find and interpret the coordinates of the vertex of the graph of $y = F(t)$.

17. The temperature T , in degrees Fahrenheit, t hours after 6 AM is given by:

$$T(t) = -\frac{1}{2}t^2 + 8t + 32, \quad 0 \leq t \leq 12$$

What is the warmest temperature of the day? When does this happen?

18. Suppose $C(x) = x^2 - 10x + 27$ represents the costs, in *hundreds*, to produce x *thousand* pens. How many pens should be produced to minimize the cost? What is this minimum cost?
19. Skippy wishes to plant a vegetable garden along one side of his house. In his garage, he found 32 linear feet of fencing. Since one side of the garden will border the house, Skippy doesn't need fencing along that side. What are the dimensions of the garden which will maximize the area of the garden? What is the maximum area of the garden?
20. In the situation of Example 2.3.4, Donnie has a nightmare that one of his alpaca herd fell into the river and drowned. To avoid this, he wants to move his rectangular pasture *away* from the river. This means that all four sides of the pasture require fencing. If the total amount of fencing available is still 200 linear feet, what dimensions maximize the area of the pasture now? What is the maximum area? Assuming an average alpaca requires 25 square feet of pasture, how many alpaca can he raise now?
21. What is the largest rectangular area one can enclose with 14 inches of string?
22. The height of an object dropped from the roof of an eight story building is modeled by $h(t) = -16t^2 + 64$, $0 \leq t \leq 2$. Here, h is the height of the object off the ground, in feet, t seconds after the object is dropped. How long before the object hits the ground?
23. The height h in feet of a model rocket above the ground t seconds after lift-off is given by $h(t) = -5t^2 + 100t$, for $0 \leq t \leq 20$. When does the rocket reach its maximum height above the ground? What is its maximum height?
24. Carl's friend Jason participates in the Highland Games. In one event, the hammer throw, the height h in feet of the hammer above the ground t seconds after Jason lets it go is modeled by $h(t) = -16t^2 + 22.08t + 6$. What is the hammer's maximum height? What is the hammer's total time in the air? Round your answers to two decimal places.

25. Assuming no air resistance or forces other than the Earth's gravity, the height above the ground at time t of a falling object is given by $s(t) = -4.9t^2 + v_0t + s_0$ where s is in meters, t is in seconds, v_0 is the object's initial velocity in meters per second and s_0 is its initial position in meters.
- What is the applied domain of this function?
 - Discuss with your classmates what each of $v_0 > 0$, $v_0 = 0$ and $v_0 < 0$ would mean.
 - Come up with a scenario in which $s_0 < 0$.
 - Let's say a slingshot is used to shoot a marble straight up from the ground ($s_0 = 0$) with an initial velocity of 15 meters per second. What is the marble's maximum height above the ground? At what time will it hit the ground?
 - Now shoot the marble from the top of a tower which is 25 meters tall. When does it hit the ground?
 - What would the height function be if instead of shooting the marble up off of the tower, you were to shoot it straight DOWN from the top of the tower?
26. The two towers of a suspension bridge are 400 feet apart. The parabolic cable¹¹ attached to the tops of the towers is 10 feet above the point on the bridge deck that is midway between the towers. If the towers are 100 feet tall, find the height of the cable directly above a point of the bridge deck that is 50 feet to the right of the left-hand tower.
27. Graph $f(x) = |1 - x^2|$
28. Find all of the points on the line $y = 1 - x$ which are 2 units from $(1, -1)$.
29. Let L be the line $y = 2x + 1$. Find a function $D(x)$ which measures the distance *squared* from a point on L to $(0, 0)$. Use this to find the point on L closest to $(0, 0)$.
30. With the help of your classmates, show that if a quadratic function $f(x) = ax^2 + bx + c$ has two real zeros then the x -coordinate of the vertex is the midpoint of the zeros.

In Exercises 31 - 36, solve the quadratic equation for the indicated variable.

- | | | |
|-------------------------------|----------------------------------|---|
| 31. $x^2 - 10y^2 = 0$ for x | 32. $y^2 - 4y = x^2 - 4$ for x | 33. $x^2 - mx = 1$ for x |
| 34. $y^2 - 3y = 4x$ for y | 35. $y^2 - 4y = x^2 - 4$ for y | 36. $-gt^2 + v_0t + s_0 = 0$ for t
(Assume $g \neq 0$.) |

¹¹The weight of the bridge deck forces the bridge cable into a parabola and a free hanging cable such as a power line does not form a parabola. We shall see in Exercise 35 in Section 6.5 what shape a free hanging cable makes.

2.3.2 ANSWERS

1. $f(x) = x^2 + 2$ (this is both forms!)

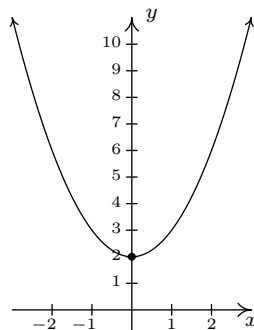
No x -intercepts y -intercept $(0, 2)$ Domain: $(-\infty, \infty)$ Range: $[2, \infty)$ Decreasing on $(-\infty, 0]$ Increasing on $[0, \infty)$ Vertex $(0, 2)$ is a minimumAxis of symmetry $x = 0$ 

2. $f(x) = -(x + 2)^2 = -x^2 - 4x - 4$

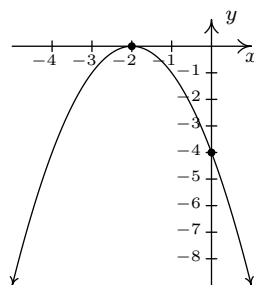
 x -intercept $(-2, 0)$ y -intercept $(0, -4)$ Domain: $(-\infty, \infty)$ Range: $(-\infty, 0]$ Increasing on $(-\infty, -2]$ Decreasing on $[-2, \infty)$ Vertex $(-2, 0)$ is a maximumAxis of symmetry $x = -2$ 

3. $f(x) = x^2 - 2x - 8 = (x - 1)^2 - 9$

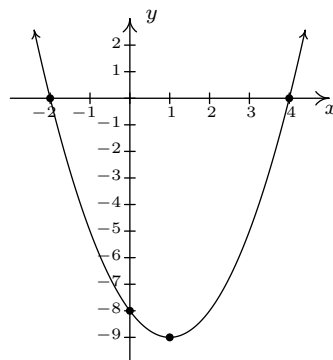
 x -intercepts $(-2, 0)$ and $(4, 0)$ y -intercept $(0, -8)$ Domain: $(-\infty, \infty)$ Range: $[-9, \infty)$ Decreasing on $(-\infty, 1]$ Increasing on $[1, \infty)$ Vertex $(1, -9)$ is a minimumAxis of symmetry $x = 1$ 

4. $f(x) = -2(x + 1)^2 + 4 = -2x^2 - 4x + 2$

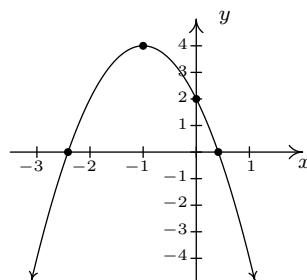
 x -intercepts $(-1 - \sqrt{2}, 0)$ and $(-1 + \sqrt{2}, 0)$ y -intercept $(0, 2)$ Domain: $(-\infty, \infty)$ Range: $(-\infty, 4]$ Increasing on $(-\infty, -1]$ Decreasing on $[-1, \infty)$ Vertex $(-1, 4)$ is a maximumAxis of symmetry $x = -1$ 

5. $f(x) = 2x^2 - 4x - 1 = 2(x - 1)^2 - 3$
 x -intercepts $\left(\frac{2-\sqrt{6}}{2}, 0\right)$ and $\left(\frac{2+\sqrt{6}}{2}, 0\right)$
 y -intercept $(0, -1)$
 Domain: $(-\infty, \infty)$
 Range: $[-3, \infty)$
 Increasing on $[1, \infty)$
 Decreasing on $(-\infty, 1]$
 Vertex $(1, -3)$ is a minimum
 Axis of symmetry $x = 1$

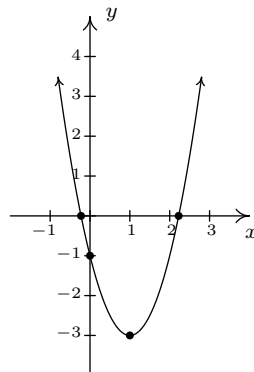

6. $f(x) = -3x^2 + 4x - 7 = -3\left(x - \frac{2}{3}\right)^2 - \frac{17}{3}$
 No x -intercepts
 y -intercept $(0, -7)$
 Domain: $(-\infty, \infty)$
 Range: $(-\infty, -\frac{17}{3}]$
 Increasing on $(-\infty, \frac{2}{3}]$
 Decreasing on $[\frac{2}{3}, \infty)$
 Vertex $(\frac{2}{3}, -\frac{17}{3})$ is a maximum
 Axis of symmetry $x = \frac{2}{3}$

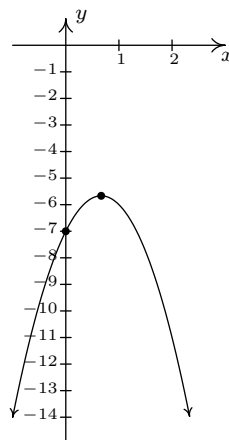

7. $f(x) = x^2 + x + 1 = \left(x + \frac{1}{2}\right)^2 + \frac{3}{4}$
 No x -intercepts
 y -intercept $(0, 1)$
 Domain: $(-\infty, \infty)$
 Range: $[\frac{3}{4}, \infty)$
 Increasing on $[-\frac{1}{2}, \infty)$
 Decreasing on $(-\infty, -\frac{1}{2}]$
 Vertex $(-\frac{1}{2}, \frac{3}{4})$ is a minimum
 Axis of symmetry $x = -\frac{1}{2}$

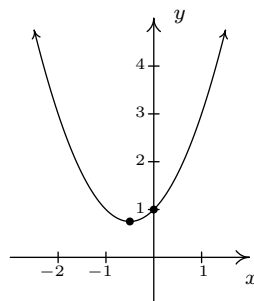

8. $f(x) = -3x^2 + 5x + 4 = -3\left(x - \frac{5}{6}\right)^2 + \frac{73}{12}$
 x -intercepts $\left(\frac{5-\sqrt{73}}{6}, 0\right)$ and $\left(\frac{5+\sqrt{73}}{6}, 0\right)$
 y -intercept $(0, 4)$
 Domain: $(-\infty, \infty)$
 Range: $(-\infty, \frac{73}{12}]$
 Increasing on $(-\infty, \frac{5}{6}]$
 Decreasing on $[\frac{5}{6}, \infty)$
 Vertex $(\frac{5}{6}, \frac{73}{12})$ is a maximum
 Axis of symmetry $x = \frac{5}{6}$

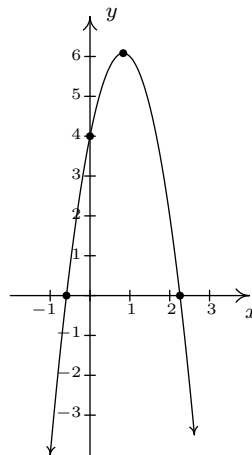

9. $f(x) = x^2 - \frac{1}{100}x - 1 = \left(x - \frac{1}{200}\right)^2 - \frac{40001}{40000}$
 x -intercepts $\left(\frac{1+\sqrt{40001}}{200}, 0\right)$ and $\left(\frac{1-\sqrt{40001}}{200}, 0\right)$
 y -intercept $(0, -1)$
 Domain: $(-\infty, \infty)$
 Range: $[-\frac{40001}{40000}, \infty)$
 Decreasing on $(-\infty, \frac{1}{200}]$
 Increasing on $[\frac{1}{200}, \infty)$
 Vertex $(\frac{1}{200}, -\frac{40001}{40000})$ is a minimum¹²
 Axis of symmetry $x = \frac{1}{200}$

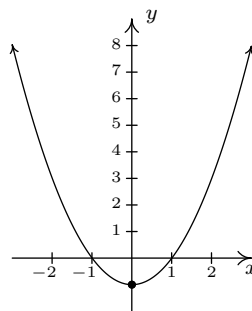

10. • $P(x) = -2x^2 + 28x - 26$, for $0 \leq x \leq 15$.
 • 7 T-shirts should be made and sold to maximize profit.
 • The maximum profit is \$72.
 • The price per T-shirt should be set at \$16 to maximize profit.
 • The break even points are $x = 1$ and $x = 13$, so to make a profit, between 1 and 13 T-shirts need to be made and sold.
11. • $P(x) = -x^2 + 25x - 100$, for $0 \leq x \leq 35$
 • Since the vertex occurs at $x = 12.5$, and it is impossible to make or sell 12.5 bottles of tonic, maximum profit occurs when either 12 or 13 bottles of tonic are made and sold.
 • The maximum profit is \$56.
 • The price per bottle can be either \$23 (to sell 12 bottles) or \$22 (to sell 13 bottles.) Both will result in the maximum profit.
 • The break even points are $x = 5$ and $x = 20$, so to make a profit, between 5 and 20 bottles of tonic need to be made and sold.

¹²You'll need to use your calculator to zoom in far enough to see that the vertex is not the y -intercept.

12.
 - $P(x) = -3x^2 + 72x - 240$, for $0 \leq x \leq 30$
 - 12 cups of lemonade need to be made and sold to maximize profit.
 - The maximum profit is 192¢ or \$1.92.
 - The price per cup should be set at 54¢ per cup to maximize profit.
 - The break even points are $x = 4$ and $x = 20$, so to make a profit, between 4 and 20 cups of lemonade need to be made and sold.
13.
 - $P(x) = -0.5x^2 + 9x - 36$, for $0 \leq x \leq 24$
 - 9 pies should be made and sold to maximize the daily profit.
 - The maximum daily profit is \$4.50.
 - The price per pie should be set at \$7.50 to maximize profit.
 - The break even points are $x = 6$ and $x = 12$, so to make a profit, between 6 and 12 pies need to be made and sold daily.
14.
 - $P(x) = -2x^2 + 120x - 1000$, for $0 \leq x \leq 70$
 - 30 scooters need to be made and sold to maximize profit.
 - The maximum monthly profit is 800 hundred dollars, or \$80,000.
 - The price per scooter should be set at 80 hundred dollars, or \$8000 per scooter.
 - The break even points are $x = 10$ and $x = 50$, so to make a profit, between 10 and 50 scooters need to be made and sold monthly.
15. 495 cookies
16. The vertex is (approximately) (29.60, 22.66), which corresponds to a maximum fuel economy of 22.66 miles per gallon, reached sometime between 2009 and 2010 (29 – 30 years after 1980.) Unfortunately, the model is only valid up until 2008 (28 years after 1980.) So, at this point, we are using the model to *predict* the maximum fuel economy.
17. 64° at 2 PM (8 hours after 6 AM.)
18. 5000 pens should be produced for a cost of \$200.
19. 8 feet by 16 feet; maximum area is 128 square feet.
20. 50 feet by 50 feet; maximum area is 2500 feet; he can raise 100 average alpacas.
21. The largest rectangle has area 12.25 square inches.
22. 2 seconds.
23. The rocket reaches its maximum height of 500 feet 10 seconds after lift-off.
24. The hammer reaches a maximum height of approximately 13.62 feet. The hammer is in the air approximately 1.61 seconds.

25. (a) The applied domain is $[0, \infty)$.
- (d) The height function in this case is $s(t) = -4.9t^2 + 15t$. The vertex of this parabola is approximately $(1.53, 11.48)$ so the maximum height reached by the marble is 11.48 meters. It hits the ground again when $t \approx 3.06$ seconds.
- (e) The revised height function is $s(t) = -4.9t^2 + 15t + 25$ which has zeros at $t \approx -1.20$ and $t \approx 4.26$. We ignore the negative value and claim that the marble will hit the ground after 4.26 seconds.
- (f) Shooting down means the initial velocity is negative so the height function becomes $s(t) = -4.9t^2 - 15t + 25$.
26. Make the vertex of the parabola $(0, 10)$ so that the point on the top of the left-hand tower where the cable connects is $(-200, 100)$ and the point on the top of the right-hand tower is $(200, 100)$. Then the parabola is given by $p(x) = \frac{9}{4000}x^2 + 10$. Standing 50 feet to the right of the left-hand tower means you're standing at $x = -150$ and $p(-150) = 60.625$. So the cable is 60.625 feet above the bridge deck there.

27. $y = |1 - x^2|$

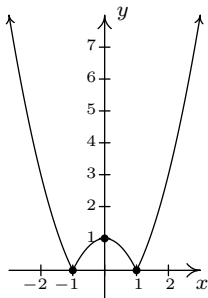

28. $\left(\frac{3 - \sqrt{7}}{2}, \frac{-1 + \sqrt{7}}{2}\right), \left(\frac{3 + \sqrt{7}}{2}, \frac{-1 - \sqrt{7}}{2}\right)$

29. $D(x) = x^2 + (2x + 1)^2 = 5x^2 + 4x + 1$, D is minimized when $x = -\frac{2}{5}$, so the point on $y = 2x + 1$ closest to $(0, 0)$ is $(-\frac{2}{5}, \frac{1}{5})$

31. $x = \pm y\sqrt{10}$

32. $x = \pm(y - 2)$

33. $x = \frac{m \pm \sqrt{m^2 + 4}}{2}$

34. $y = \frac{3 \pm \sqrt{16x + 9}}{2}$

35. $y = 2 \pm x$

36. $t = \frac{v_0 \pm \sqrt{v_0^2 + 4gs_0}}{2g}$

2.4 INEQUALITIES WITH ABSOLUTE VALUE AND QUADRATIC FUNCTIONS

In this section, not only do we develop techniques for solving various classes of inequalities analytically, we also look at them graphically. The first example motivates the core ideas.

Example 2.4.1. Let $f(x) = 2x - 1$ and $g(x) = 5$.

1. Solve $f(x) = g(x)$.
2. Solve $f(x) < g(x)$.
3. Solve $f(x) > g(x)$.
4. Graph $y = f(x)$ and $y = g(x)$ on the same set of axes and interpret your solutions to parts 1 through 3 above.

Solution.

1. To solve $f(x) = g(x)$, we replace $f(x)$ with $2x - 1$ and $g(x)$ with 5 to get $2x - 1 = 5$. Solving for x , we get $x = 3$.
2. The inequality $f(x) < g(x)$ is equivalent to $2x - 1 < 5$. Solving gives $x < 3$ or $(-\infty, 3)$.
3. To find where $f(x) > g(x)$, we solve $2x - 1 > 5$. We get $x > 3$, or $(3, \infty)$.
4. To graph $y = f(x)$, we graph $y = 2x - 1$, which is a line with a y -intercept of $(0, -1)$ and a slope of 2. The graph of $y = g(x)$ is $y = 5$ which is a horizontal line through $(0, 5)$.

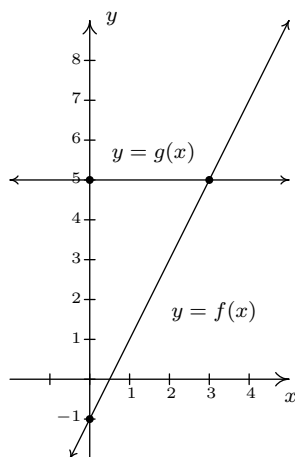

To see the connection between the graph and the Algebra, we recall the Fundamental Graphing Principle for Functions in Section 1.6: the point (a, b) is on the graph of f if and only if $f(a) = b$. In other words, a generic point on the graph of $y = f(x)$ is $(x, f(x))$, and a generic

point on the graph of $y = g(x)$ is $(x, g(x))$. When we seek solutions to $f(x) = g(x)$, we are looking for x values whose y values on the graphs of f and g are the same. In part 1, we found $x = 3$ is the solution to $f(x) = g(x)$. Sure enough, $f(3) = 5$ and $g(3) = 5$ so that the point $(3, 5)$ is on both graphs. In other words, the graphs of f and g *intersect* at $(3, 5)$. In part 2, we set $f(x) < g(x)$ and solved to find $x < 3$. For $x < 3$, the point $(x, f(x))$ is *below* $(x, g(x))$ since the y values on the graph of f are less than the y values on the graph of g there. Analogously, in part 3, we solved $f(x) > g(x)$ and found $x > 3$. For $x > 3$, note that the graph of f is *above* the graph of g , since the y values on the graph of f are greater than the y values on the graph of g for those values of x .

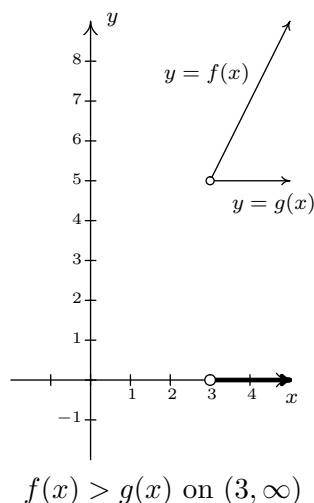
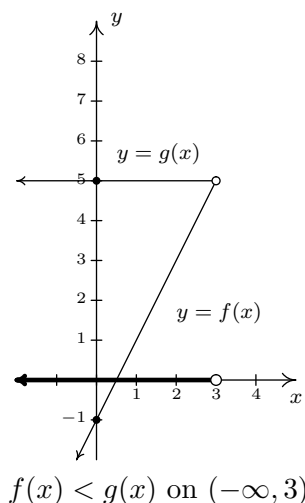

□

The preceding example demonstrates the following, which is a consequence of the Fundamental Graphing Principle for Functions.

Graphical Interpretation of Equations and Inequalities

Suppose f and g are functions.

- The solutions to $f(x) = g(x)$ are the x values where the graphs of $y = f(x)$ and $y = g(x)$ intersect.
- The solution to $f(x) < g(x)$ is the set of x values where the graph of $y = f(x)$ is *below* the graph of $y = g(x)$.
- The solution to $f(x) > g(x)$ is the set of x values where the graph of $y = f(x)$ is *above* the graph of $y = g(x)$.

The next example turns the tables and furnishes the graphs of two functions and asks for solutions to equations and inequalities.

Example 2.4.2. The graphs of f and g are below. (The graph of $y = g(x)$ is bolded.) Use these graphs to answer the following questions.

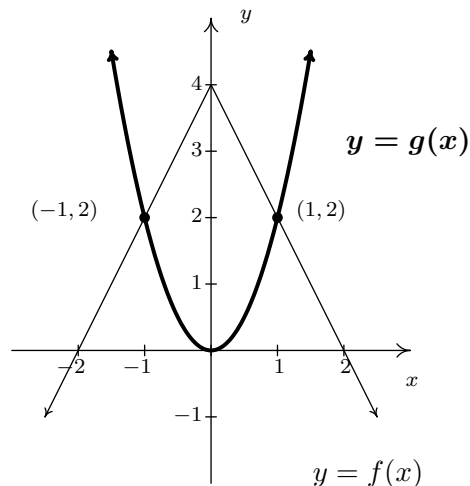

1. Solve $f(x) = g(x)$.
2. Solve $f(x) < g(x)$.
3. Solve $f(x) \geq g(x)$.

Solution.

1. To solve $f(x) = g(x)$, we look for where the graphs of f and g intersect. These appear to be at the points $(-1, 2)$ and $(1, 2)$, so our solutions to $f(x) = g(x)$ are $x = -1$ and $x = 1$.
2. To solve $f(x) < g(x)$, we look for where the graph of f is below the graph of g . This appears to happen for the x values less than -1 and greater than 1 . Our solution is $(-\infty, -1) \cup (1, \infty)$.
3. To solve $f(x) \geq g(x)$, we look for solutions to $f(x) = g(x)$ as well as $f(x) > g(x)$. We solved the former equation and found $x = \pm 1$. To solve $f(x) > g(x)$, we look for where the graph of f is above the graph of g . This appears to happen between $x = -1$ and $x = 1$, on the interval $(-1, 1)$. Hence, our solution to $f(x) \geq g(x)$ is $[-1, 1]$.

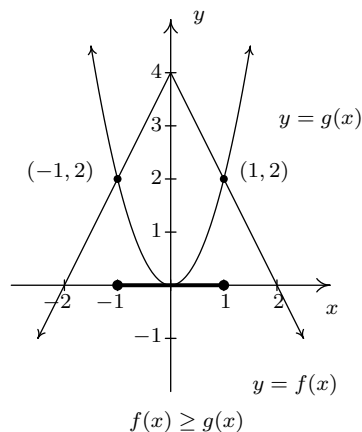
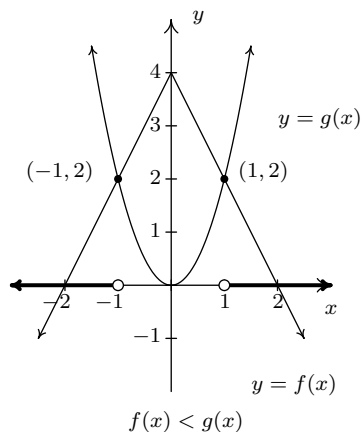

□

We now turn our attention to solving inequalities involving the absolute value. We have the following theorem from Intermediate Algebra to help us.

Theorem 2.4. Inequalities Involving the Absolute Value: Let c be a real number.

- For $c > 0$, $|x| < c$ is equivalent to $-c < x < c$.
- For $c > 0$, $|x| \leq c$ is equivalent to $-c \leq x \leq c$.
- For $c \leq 0$, $|x| < c$ has no solution, and for $c < 0$, $|x| \leq c$ has no solution.
- For $c \geq 0$, $|x| > c$ is equivalent to $x < -c$ or $x > c$.
- For $c \geq 0$, $|x| \geq c$ is equivalent to $x \leq -c$ or $x \geq c$.
- For $c < 0$, $|x| > c$ and $|x| \geq c$ are true for all real numbers.

As with Theorem 2.1 in Section 2.2, we could argue Theorem 2.4 using cases. However, in light of what we have developed in this section, we can understand these statements graphically. For instance, if $c > 0$, the graph of $y = c$ is a horizontal line which lies above the x -axis through $(0, c)$. To solve $|x| < c$, we are looking for the x values where the graph of $y = |x|$ is below the graph of $y = c$. We know that the graphs intersect when $|x| = c$, which, from Section 2.2, we know happens when $x = c$ or $x = -c$. Graphing, we get

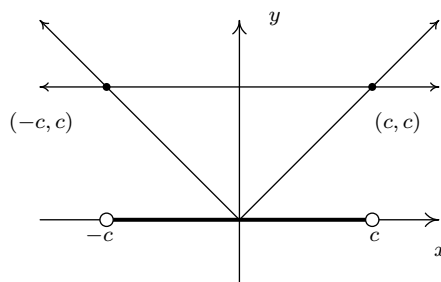

We see that the graph of $y = |x|$ is below $y = c$ for x between $-c$ and c , and hence we get $|x| < c$ is equivalent to $-c < x < c$. The other properties in Theorem 2.4 can be shown similarly.

Example 2.4.3. Solve the following inequalities analytically; check your answers graphically.

1. $|x - 1| \geq 3$

2. $4 - 3|2x + 1| > -2$

3. $2 < |x - 1| \leq 5$

4. $|x + 1| \geq \frac{x + 4}{2}$

Solution.

1. From Theorem 2.4, $|x - 1| \geq 3$ is equivalent to $x - 1 \leq -3$ or $x - 1 \geq 3$. Solving, we get $x \leq -2$ or $x \geq 4$, which, in interval notation is $(-\infty, -2] \cup [4, \infty)$. Graphically, we have

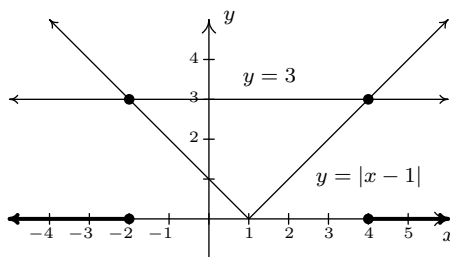

We see that the graph of $y = |x - 1|$ is above the horizontal line $y = 3$ for $x < -2$ and $x > 4$ hence this is where $|x - 1| > 3$. The two graphs intersect when $x = -2$ and $x = 4$, so we have graphical confirmation of our analytic solution.

2. To solve $4 - 3|2x + 1| > -2$ analytically, we first isolate the absolute value before applying Theorem 2.4. To that end, we get $-3|2x + 1| > -6$ or $|2x + 1| < 2$. Rewriting, we now have $-2 < 2x + 1 < 2$ so that $-\frac{3}{2} < x < \frac{1}{2}$. In interval notation, we write $(-\frac{3}{2}, \frac{1}{2})$. Graphically we see that the graph of $y = 4 - 3|2x + 1|$ is above $y = -2$ for x values between $-\frac{3}{2}$ and $\frac{1}{2}$.

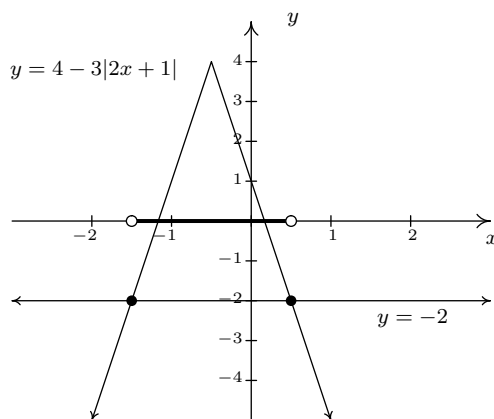

3. Rewriting the compound inequality $2 < |x - 1| \leq 5$ as ' $2 < |x - 1|$ and $|x - 1| \leq 5$ ' allows us to solve each piece using Theorem 2.4. The first inequality, $2 < |x - 1|$ can be re-written as $|x - 1| > 2$ so $x - 1 < -2$ or $x - 1 > 2$. We get $x < -1$ or $x > 3$. Our solution to the first inequality is then $(-\infty, -1) \cup (3, \infty)$. For $|x - 1| \leq 5$, we combine results in Theorems 2.1 and 2.4 to get $-5 \leq x - 1 \leq 5$ so that $-4 \leq x \leq 6$, or $[-4, 6]$. Our solution to $2 < |x - 1| \leq 5$ is comprised of values of x which satisfy both parts of the inequality, so we take the intersection¹ of $(-\infty, -1) \cup (3, \infty)$ and $[-4, 6]$ to get $[-4, -1) \cup (3, 6]$. Graphically, we see that the graph of $y = |x - 1|$ is 'between' the horizontal lines $y = 2$ and $y = 5$ for x values between -4 and -1 as well as those between 3 and 6 . Including the x values where $y = |x - 1|$ and $y = 5$ intersect, we get

¹See Definition 1.2 in Section 1.1.1.

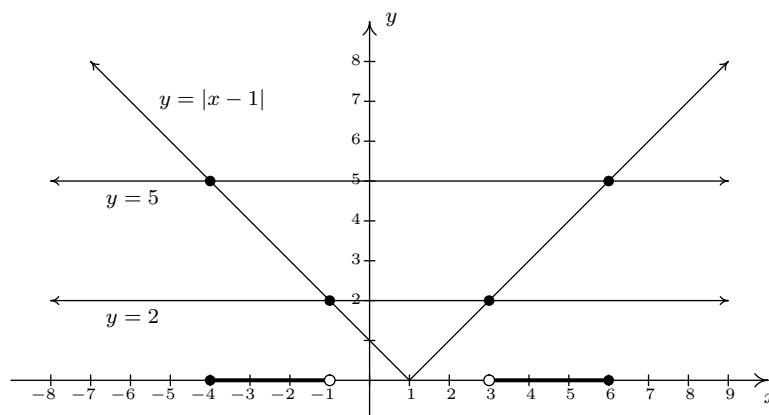

4. We need to exercise some special caution when solving $|x + 1| \geq \frac{x+4}{2}$. As we saw in Example 2.2.1 in Section 2.2, when variables are both inside and outside of the absolute value, it's usually best to refer to the definition of absolute value, Definition 2.4, to remove the absolute values and proceed from there. To that end, we have $|x + 1| = -(x + 1)$ if $x < -1$ and $|x + 1| = x + 1$ if $x \geq -1$. We break the inequality into cases, the first case being when $x < -1$. For these values of x , our inequality becomes $-(x + 1) \geq \frac{x+4}{2}$. Solving, we get $-2x - 2 \geq x + 4$, so that $-3x \geq 6$, which means $x \leq -2$. Since all of these solutions fall into the category $x < -1$, we keep them all. For the second case, we assume $x \geq -1$. Our inequality becomes $x + 1 \geq \frac{x+4}{2}$, which gives $2x + 2 \geq x + 4$ or $x \geq 2$. Since all of these values of x are greater than or equal to -1 , we accept all of these solutions as well. Our final answer is $(-\infty, -2] \cup [2, \infty)$.

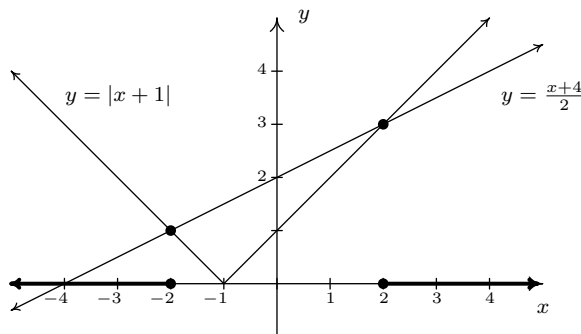

□

We now turn our attention to quadratic inequalities. In the last example of Section 2.3, we needed to determine the solution to $x^2 - x - 6 < 0$. We will now re-visit this problem using some of the techniques developed in this section not only to reinforce our solution in Section 2.3, but to also help formulate a general analytic procedure for solving all quadratic inequalities. If we consider $f(x) = x^2 - x - 6$ and $g(x) = 0$, then solving $x^2 - x - 6 < 0$ corresponds graphically to finding

the values of x for which the graph of $y = f(x) = x^2 - x - 6$ (the parabola) is below the graph of $y = g(x) = 0$ (the x -axis). We've provided the graph again for reference.

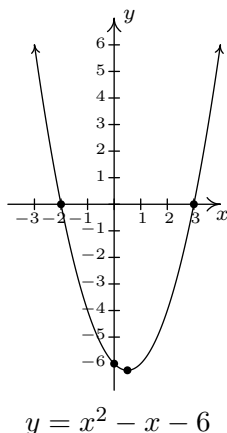

We can see that the graph of f does dip below the x -axis between its two x -intercepts. The zeros of f are $x = -2$ and $x = 3$ in this case and they divide the domain (the x -axis) into three intervals: $(-\infty, -2)$, $(-2, 3)$ and $(3, \infty)$. For every number in $(-\infty, -2)$, the graph of f is above the x -axis; in other words, $f(x) > 0$ for all x in $(-\infty, -2)$. Similarly, $f(x) < 0$ for all x in $(-2, 3)$, and $f(x) > 0$ for all x in $(3, \infty)$. We can schematically represent this with the **sign diagram** below.

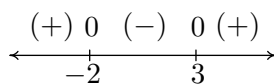

Here, the (+) above a portion of the number line indicates $f(x) > 0$ for those values of x ; the (-) indicates $f(x) < 0$ there. The numbers labeled on the number line are the zeros of f , so we place 0 above them. We see at once that the solution to $f(x) < 0$ is $(-2, 3)$.

Our next goal is to establish a procedure by which we can generate the sign diagram without graphing the function. An important property² of quadratic functions is that if the function is positive at one point and negative at another, the function must have at least one zero in between. Graphically, this means that a parabola can't be above the x -axis at one point and below the x -axis at another point without crossing the x -axis. This allows us to determine the sign of *all* of the function values on a given interval by testing the function at just *one* value in the interval. This gives us the following.

²We will give this property a name in Chapter 3 and revisit this concept then.

Steps for Solving a Quadratic Inequality

1. Rewrite the inequality, if necessary, as a quadratic function $f(x)$ on one side of the inequality and 0 on the other.
2. Find the zeros of f and place them on the number line with the number 0 above them.
3. Choose a real number, called a **test value**, in each of the intervals determined in step 2.
4. Determine the sign of $f(x)$ for each test value in step 3, and write that sign above the corresponding interval.
5. Choose the intervals which correspond to the correct sign to solve the inequality.

Example 2.4.4. Solve the following inequalities analytically using sign diagrams. Verify your answer graphically.

1. $2x^2 \leq 3 - x$

2. $x^2 - 2x > 1$

3. $x^2 + 1 \leq 2x$

4. $2x - x^2 \geq |x - 1| - 1$

Solution.

1. To solve $2x^2 \leq 3 - x$, we first get 0 on one side of the inequality which yields $2x^2 + x - 3 \leq 0$. We find the zeros of $f(x) = 2x^2 + x - 3$ by solving $2x^2 + x - 3 = 0$ for x . Factoring gives $(2x + 3)(x - 1) = 0$, so $x = -\frac{3}{2}$ or $x = 1$. We place these values on the number line with 0 above them and choose test values in the intervals $(-\infty, -\frac{3}{2})$, $(-\frac{3}{2}, 1)$ and $(1, \infty)$. For the interval $(-\infty, -\frac{3}{2})$, we choose³ $x = -2$; for $(-\frac{3}{2}, 1)$, we pick $x = 0$; and for $(1, \infty)$, $x = 2$. Evaluating the function at the three test values gives us $f(-2) = 3 > 0$, so we place (+) above $(-\infty, -\frac{3}{2})$; $f(0) = -3 < 0$, so (-) goes above the interval $(-\frac{3}{2}, 1)$; and, $f(2) = 7$, which means (+) is placed above $(1, \infty)$. Since we are solving $2x^2 + x - 3 \leq 0$, we look for solutions to $2x^2 + x - 3 < 0$ as well as solutions for $2x^2 + x - 3 = 0$. For $2x^2 + x - 3 < 0$, we need the intervals which we have a (-). Checking the sign diagram, we see this is $(-\frac{3}{2}, 1)$. We know $2x^2 + x - 3 = 0$ when $x = -\frac{3}{2}$ and $x = 1$, so our final answer is $[-\frac{3}{2}, 1]$.

To verify our solution graphically, we refer to the original inequality, $2x^2 \leq 3 - x$. We let $g(x) = 2x^2$ and $h(x) = 3 - x$. We are looking for the x values where the graph of g is below that of h (the solution to $g(x) < h(x)$) as well as the points of intersection (the solutions to $g(x) = h(x)$). The graphs of g and h are given on the right with the sign chart on the left.

³We have to choose something in each interval. If you don't like our choices, please feel free to choose different numbers. You'll get the same sign chart.

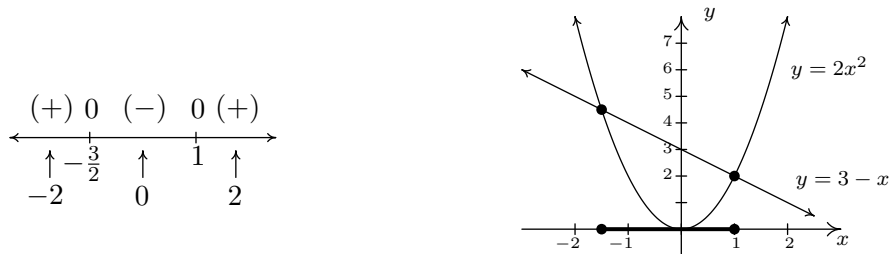

2. Once again, we re-write $x^2 - 2x > 1$ as $x^2 - 2x - 1 > 0$ and we identify $f(x) = x^2 - 2x - 1$. When we go to find the zeros of f , we find, to our chagrin, that the quadratic $x^2 - 2x - 1$ doesn't factor nicely. Hence, we resort to the quadratic formula to solve $x^2 - 2x - 1 = 0$, and arrive at $x = 1 \pm \sqrt{2}$. As before, these zeros divide the number line into three pieces. To help us decide on test values, we approximate $1 - \sqrt{2} \approx -0.4$ and $1 + \sqrt{2} \approx 2.4$. We choose $x = -1$, $x = 0$ and $x = 3$ as our test values and find $f(-1) = 2$, which is (+); $f(0) = -1$ which is (-); and $f(3) = 2$ which is (+) again. Our solution to $x^2 - 2x - 1 > 0$ is where we have (+), so, in interval notation $(-\infty, 1 - \sqrt{2}) \cup (1 + \sqrt{2}, \infty)$. To check the inequality $x^2 - 2x > 1$ graphically, we set $g(x) = x^2 - 2x$ and $h(x) = 1$. We are looking for the x values where the graph of g is above the graph of h . As before we present the graphs on the right and the sign chart on the left.

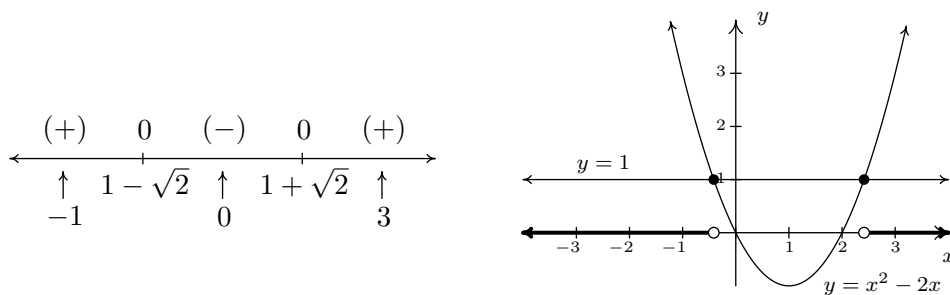

3. To solve $x^2 + 1 \leq 2x$, as before, we solve $x^2 - 2x + 1 \leq 0$. Setting $f(x) = x^2 - 2x + 1 = 0$, we find the only one zero of f , $x = 1$. This one x value divides the number line into two intervals, from which we choose $x = 0$ and $x = 2$ as test values. We find $f(0) = 1 > 0$ and $f(2) = 1 > 0$. Since we are looking for solutions to $x^2 - 2x + 1 \leq 0$, we are looking for x values where $x^2 - 2x + 1 < 0$ as well as where $x^2 - 2x + 1 = 0$. Looking at our sign diagram, there are no places where $x^2 - 2x + 1 < 0$ (there are no (-)), so our solution is only $x = 1$ (where $x^2 - 2x + 1 = 0$). We write this as $\{1\}$. Graphically, we solve $x^2 + 1 \leq 2x$ by graphing $g(x) = x^2 + 1$ and $h(x) = 2x$. We are looking for the x values where the graph of g is below the graph of h (for $x^2 + 1 < 2x$) and where the two graphs intersect ($x^2 + 1 = 2x$). Notice that the line and the parabola touch at $(1, 2)$, but the parabola is always above the line otherwise.⁴

⁴In this case, we say the line $y = 2x$ is **tangent** to $y = x^2 + 1$ at $(1, 2)$. Finding tangent lines to arbitrary functions is a fundamental problem solved, in general, with Calculus.

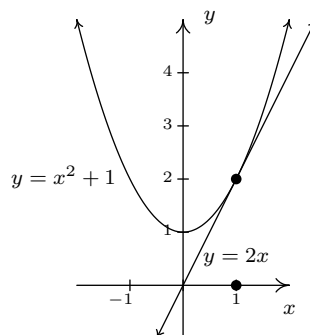
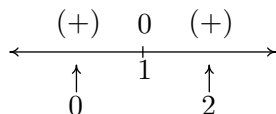

4. To solve our last inequality, $2x - x^2 \geq |x - 1| - 1$, we re-write the absolute value using cases. For $x < 1$, $|x - 1| = -(x - 1) = 1 - x$, so we get $2x - x^2 \geq 1 - x - 1$, or $x^2 - 3x \leq 0$. Finding the zeros of $f(x) = x^2 - 3x$, we get $x = 0$ and $x = 3$. However, we are only concerned with the portion of the number line where $x < 1$, so the only zero that we concern ourselves with is $x = 0$. This divides the interval $x < 1$ into two intervals: $(-\infty, 0)$ and $(0, 1)$. We choose $x = -1$ and $x = \frac{1}{2}$ as our test values. We find $f(-1) = 4$ and $f(\frac{1}{2}) = -\frac{5}{4}$. Hence, our solution to $x^2 - 3x \leq 0$ for $x < 1$ is $[0, 1)$. Next, we turn our attention to the case $x \geq 1$. Here, $|x - 1| = x - 1$, so our original inequality becomes $2x - x^2 \geq x - 1 - 1$, or $x^2 - x - 2 \leq 0$. Setting $g(x) = x^2 - x - 2$, we find the zeros of g to be $x = -1$ and $x = 2$. Of these, only $x = 2$ lies in the region $x \geq 1$, so we ignore $x = -1$. Our test intervals are now $[1, 2)$ and $(2, \infty)$. We choose $x = 1$ and $x = 3$ as our test values and find $g(1) = -2$ and $g(3) = 4$. Hence, our solution to $g(x) = x^2 - x - 2 \leq 0$, in this region is $[1, 2)$.

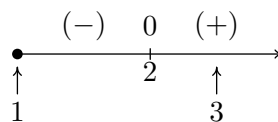
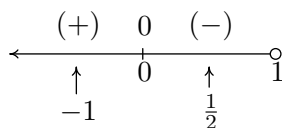

Combining these into one sign diagram, we have that our solution is $[0, 2]$. Graphically, to check $2x - x^2 \geq |x - 1| - 1$, we set $h(x) = 2x - x^2$ and $i(x) = |x - 1| - 1$ and look for the x values where the graph of h is above the the graph of i (the solution of $h(x) > i(x)$) as well as the x -coordinates of the intersection points of both graphs (where $h(x) = i(x)$). The combined sign chart is given on the left and the graphs are on the right.

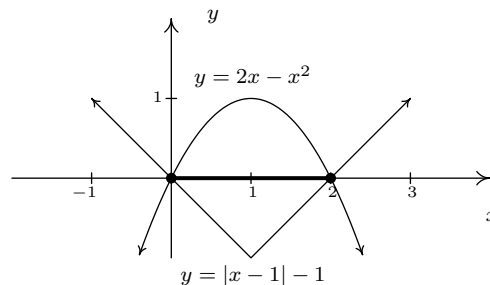
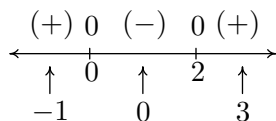

□

One of the classic applications of inequalities is the notion of tolerances.⁵ Recall that for real numbers x and c , the quantity $|x - c|$ may be interpreted as the distance from x to c . Solving inequalities of the form $|x - c| \leq d$ for $d \geq 0$ can then be interpreted as finding all numbers x which lie within d units of c . We can think of the number d as a ‘tolerance’ and our solutions x as being within an accepted tolerance of c . We use this principle in the next example.

Example 2.4.5. The area A (in square inches) of a square piece of particle board which measures x inches on each side is $A(x) = x^2$. Suppose a manufacturer needs to produce a 24 inch by 24 inch square piece of particle board as part of a home office desk kit. How close does the side of the piece of particle board need to be cut to 24 inches to guarantee that the area of the piece is within a tolerance of 0.25 square inches of the target area of 576 square inches?

Solution. Mathematically, we express the desire for the area $A(x)$ to be within 0.25 square inches of 576 as $|A - 576| \leq 0.25$. Since $A(x) = x^2$, we get $|x^2 - 576| \leq 0.25$, which is equivalent to $-0.25 \leq x^2 - 576 \leq 0.25$. One way to proceed at this point is to solve the two inequalities $-0.25 \leq x^2 - 576$ and $x^2 - 576 \leq 0.25$ individually using sign diagrams and then taking the intersection of the solution sets. While this way will (eventually) lead to the correct answer, we take this opportunity to showcase the increasing property of the square root: if $0 \leq a \leq b$, then $\sqrt{a} \leq \sqrt{b}$. To use this property, we proceed as follows

$$\begin{array}{rcll} -0.25 \leq x^2 - 576 & \leq 0.25 & & \\ 575.75 \leq x^2 & \leq 576.25 & \text{(add 576 across the inequalities.)} & \\ \sqrt{575.75} \leq \sqrt{x^2} & \leq \sqrt{576.25} & \text{(take square roots.)} & \\ \sqrt{575.75} \leq |x| & \leq \sqrt{576.25} & (\sqrt{x^2} = |x|) & \end{array}$$

By Theorem 2.4, we find the solution to $\sqrt{575.75} \leq |x|$ to be $(-\infty, -\sqrt{575.75}] \cup [\sqrt{575.75}, \infty)$ and the solution to $|x| \leq \sqrt{576.25}$ to be $[-\sqrt{576.25}, \sqrt{576.25}]$. To solve $\sqrt{575.75} \leq |x| \leq \sqrt{576.25}$, we intersect these two sets to get $[-\sqrt{576.25}, -\sqrt{575.75}] \cup [\sqrt{575.75}, \sqrt{576.25}]$. Since x represents a length, we discard the negative answers and get $[\sqrt{575.75}, \sqrt{576.25}]$. This means that the side of the piece of particle board must be cut between $\sqrt{575.75} \approx 23.995$ and $\sqrt{576.25} \approx 24.005$ inches, a tolerance of (approximately) 0.005 inches of the target length of 24 inches. \square

Our last example in the section demonstrates how inequalities can be used to describe regions in the plane, as we saw earlier in Section 1.2.

Example 2.4.6. Sketch the following relations.

1. $R = \{(x, y) : y > |x|\}$
2. $S = \{(x, y) : y \leq 2 - x^2\}$
3. $T = \{(x, y) : |x| < y \leq 2 - x^2\}$

⁵The underlying concept of Calculus can be phrased in terms of tolerances, so this is well worth your attention.

Solution.

1. The relation R consists of all points (x, y) whose y -coordinate is greater than $|x|$. If we graph $y = |x|$, then we want all of the points in the plane *above* the points on the graph. Dotted the graph of $y = |x|$ as we have done before to indicate that the points on the graph itself are not in the relation, we get the shaded region below on the left.
2. For a point to be in S , its y -coordinate must be less than or equal to the y -coordinate on the parabola $y = 2 - x^2$. This is the set of all points *below* or *on* the parabola $y = 2 - x^2$.

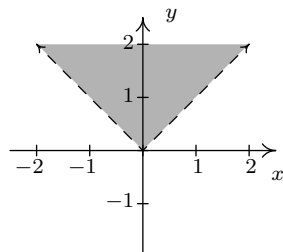
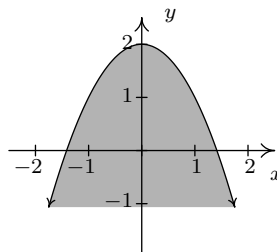
The graph of R The graph of S

3. Finally, the relation T takes the points whose y -coordinates satisfy both the conditions given in R and those of S . Thus we shade the region between $y = |x|$ and $y = 2 - x^2$, keeping those points on the parabola, but not the points on $y = |x|$. To get an accurate graph, we need to find where these two graphs intersect, so we set $|x| = 2 - x^2$. Proceeding as before, breaking this equation into cases, we get $x = -1, 1$. Graphing yields

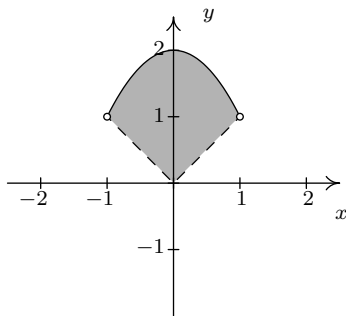
The graph of T

□

2.4.1 EXERCISES

In Exercises 1 - 32, solve the inequality. Write your answer using interval notation.

1. $|3x - 5| \leq 4$
 2. $|7x + 2| > 10$
 3. $|2x + 1| - 5 < 0$
 4. $|2 - x| - 4 \geq -3$
 5. $|3x + 5| + 2 < 1$
 6. $2|7 - x| + 4 > 1$
 7. $2 \leq |4 - x| < 7$
 8. $1 < |2x - 9| \leq 3$
 9. $|x + 3| \geq |6x + 9|$
 10. $|x - 3| - |2x + 1| < 0$
 11. $|1 - 2x| \geq x + 5$
 12. $x + 5 < |x + 5|$
 13. $x \geq |x + 1|$
 14. $|2x + 1| \leq 6 - x$
 15. $x + |2x - 3| < 2$
 16. $|3 - x| \geq x - 5$
 17. $x^2 + 2x - 3 \geq 0$
 18. $16x^2 + 8x + 1 > 0$
 19. $x^2 + 9 < 6x$
 20. $9x^2 + 16 \geq 24x$
 21. $x^2 + 4 \leq 4x$
 22. $x^2 + 1 < 0$
 23. $3x^2 \leq 11x + 4$
 24. $x > x^2$
 25. $2x^2 - 4x - 1 > 0$
 26. $5x + 4 \leq 3x^2$
 27. $2 \leq |x^2 - 9| < 9$
 28. $x^2 \leq |4x - 3|$
 29. $x^2 + x + 1 \geq 0$
 30. $x^2 \geq |x|$
 31. $x|x + 5| \geq -6$
 32. $x|x - 3| < 2$
33. The profit, in dollars, made by selling x bottles of 100% All-Natural Certified Free-Trade Organic Sasquatch Tonic is given by $P(x) = -x^2 + 25x - 100$, for $0 \leq x \leq 35$. How many bottles of tonic must be sold to make at least \$50 in profit?
34. Suppose $C(x) = x^2 - 10x + 27$, $x \geq 0$ represents the costs, in *hundreds* of dollars, to produce x *thousand* pens. Find the number of pens which can be produced for no more than \$1100.
35. The temperature T , in degrees Fahrenheit, t hours after 6 AM is given by $T(t) = -\frac{1}{2}t^2 + 8t + 32$, for $0 \leq t \leq 12$. When is it warmer than 42° Fahrenheit?

36. The height h in feet of a model rocket above the ground t seconds after lift-off is given by $h(t) = -5t^2 + 100t$, for $0 \leq t \leq 20$. When is the rocket at least 250 feet off the ground? Round your answer to two decimal places.
37. If a slingshot is used to shoot a marble straight up into the air from 2 meters above the ground with an initial velocity of 30 meters per second, for what values of time t will the marble be over 35 meters above the ground? (Refer to Exercise 25 in Section 2.3 for assistance if needed.) Round your answers to two decimal places.
38. What temperature values in degrees Celsius are equivalent to the temperature range $50^\circ F$ to $95^\circ F$? (Refer to Exercise 35 in Section 2.1 for assistance if needed.)

In Exercises 39 - 42, write and solve an inequality involving absolute values for the given statement.

39. Find all real numbers x so that x is within 4 units of 2.
40. Find all real numbers x so that $3x$ is within 2 units of -1 .
41. Find all real numbers x so that x^2 is within 1 unit of 3.
42. Find all real numbers x so that x^2 is at least 7 units away from 4.
43. The surface area S of a cube with edge length x is given by $S(x) = 6x^2$ for $x > 0$. Suppose the cubes your company manufactures are supposed to have a surface area of exactly 42 square centimeters, but the machines you own are old and cannot always make a cube with the precise surface area desired. Write an inequality using absolute value that says the surface area of a given cube is no more than 3 square centimeters away (high or low) from the target of 42 square centimeters. Solve the inequality and write your answer using interval notation.
44. Suppose f is a function, L is a real number and ε is a positive number. Discuss with your classmates what the inequality $|f(x) - L| < \varepsilon$ means algebraically and graphically.⁶

In Exercises 45 - 50, sketch the graph of the relation.

45. $R = \{(x, y) : y \leq x - 1\}$
46. $R = \{(x, y) : y > x^2 + 1\}$
47. $R = \{(x, y) : -1 < y \leq 2x + 1\}$
48. $R = \{(x, y) : x^2 \leq y < x + 2\}$
49. $R = \{(x, y) : |x| - 4 < y < 2 - x\}$
50. $R = \{(x, y) : x^2 < y \leq |4x - 3|\}$
51. Prove the second, third and fourth parts of Theorem 2.4.

⁶Understanding this type of inequality is really important in Calculus.

2.4.2 ANSWERS

1. $[\frac{1}{3}, 3]$
2. $(-\infty, -\frac{12}{7}) \cup (\frac{8}{7}, \infty)$
3. $(-3, 2)$
4. $(-\infty, 1] \cup [3, \infty)$
5. No solution
6. $(-\infty, \infty)$
7. $(-3, 2] \cup [6, 11)$
8. $[3, 4) \cup (5, 6]$
9. $[-\frac{12}{7}, -\frac{6}{5}]$
10. $(-\infty, -4) \cup (\frac{2}{3}, \infty)$
11. $(-\infty, -\frac{4}{3}] \cup [6, \infty)$
12. $(-\infty, -5)$
13. No Solution.
14. $[-7, \frac{5}{3}]$
15. $(1, \frac{5}{3})$
16. $(-\infty, \infty)$
17. $(-\infty, -3] \cup [1, \infty)$
18. $(-\infty, -\frac{1}{4}) \cup (-\frac{1}{4}, \infty)$
19. No solution
20. $(-\infty, \infty)$
21. $\{2\}$
22. No solution
23. $[-\frac{1}{3}, 4]$
24. $(0, 1)$
25. $(-\infty, 1 - \frac{\sqrt{6}}{2}) \cup (1 + \frac{\sqrt{6}}{2}, \infty)$
26. $(-\infty, \frac{5-\sqrt{73}}{6}] \cup [\frac{5+\sqrt{73}}{6}, \infty)$
27. $(-3\sqrt{2}, -\sqrt{11}) \cup [-\sqrt{7}, 0) \cup (0, \sqrt{7}] \cup [\sqrt{11}, 3\sqrt{2})$
28. $[-2 - \sqrt{7}, -2 + \sqrt{7}] \cup [1, 3]$
29. $(-\infty, \infty)$
30. $(-\infty, -1] \cup \{0\} \cup [1, \infty)$
31. $[-6, -3] \cup [-2, \infty)$
32. $(-\infty, 1) \cup (2, \frac{3+\sqrt{17}}{2})$
33. $P(x) \geq 50$ on $[10, 15]$. This means anywhere between 10 and 15 bottles of tonic need to be sold to earn at least \$50 in profit.
34. $C(x) \leq 11$ on $[2, 8]$. This means anywhere between 2000 and 8000 pens can be produced and the cost will not exceed \$1100.
35. $T(t) > 42$ on $(8 - 2\sqrt{11}, 8 + 2\sqrt{11}) \approx (1.37, 14.63)$, which corresponds to between 7:22 AM (1.37 hours after 6 AM) to 8:38 PM (14.63 hours after 6 AM.) However, since the model is valid only for $t, 0 \leq t \leq 12$, we restrict our answer and find it is warmer than 42° Fahrenheit from 7:22 AM to 6 PM.

36. $h(t) \geq 250$ on $[10 - 5\sqrt{2}, 10 + 5\sqrt{2}] \approx [2.93, 17.07]$. This means the rocket is at least 250 feet off the ground between 2.93 and 17.07 seconds after lift off.
37. $s(t) = -4.9t^2 + 30t + 2$. $s(t) > 35$ on (approximately) $(1.44, 4.68)$. This means between 1.44 and 4.68 seconds after it is launched into the air, the marble is more than 35 feet off the ground.
38. From our previous work $C(F) = \frac{5}{9}(F - 32)$ so $50 \leq F \leq 95$ becomes $10 \leq C \leq 35$.
39. $|x - 2| \leq 4$, $[-2, 6]$
40. $|3x + 1| \leq 2$, $[-1, \frac{1}{3}]$
41. $|x^2 - 3| \leq 1$, $[-2, -\sqrt{2}] \cup [\sqrt{2}, 2]$
42. $|x^2 - 4| \geq 7$, $(-\infty, -\sqrt{11}] \cup [\sqrt{11}, \infty)$
43. Solving $|S(x) - 42| \leq 3$, and disregarding the negative solutions yields $[\sqrt{\frac{13}{2}}, \sqrt{\frac{15}{2}}] \approx [2.550, 2.739]$. The edge length must be within 2.550 and 2.739 centimeters.

45.

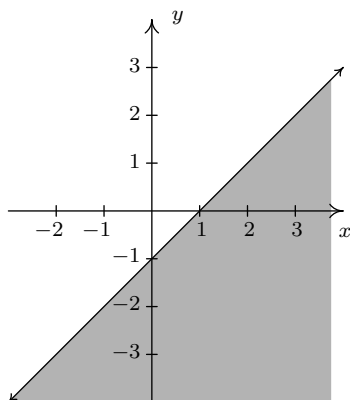

46.

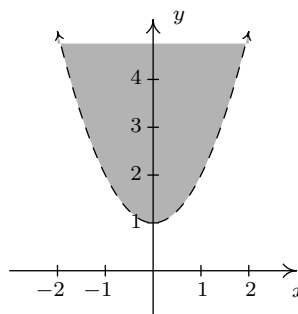

47.

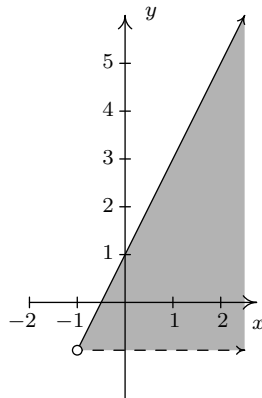

48.

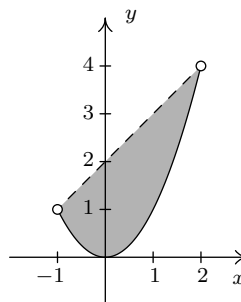

49.

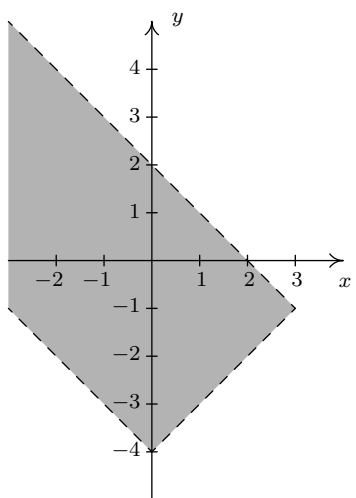

50.

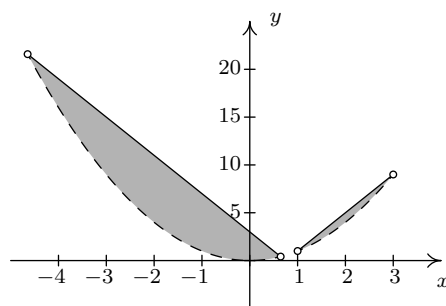

2.5 REGRESSION

We have seen examples already in the text where linear and quadratic functions are used to model a wide variety of real world phenomena ranging from production costs to the height of a projectile above the ground. In this section, we use some basic tools from statistical analysis to quantify linear and quadratic trends that we may see in real world data in order to generate linear and quadratic models. Our goal is to give the reader an understanding of the basic processes involved, but we are quick to refer the reader to a more advanced course¹ for a complete exposition of this material. Suppose we collected three data points: $\{(1, 2), (3, 1), (4, 3)\}$. By plotting these points, we can clearly see that they do not lie along the same line. If we pick any two of the points, we can find a line containing both which completely misses the third, but our aim is to find a line which is in some sense ‘close’ to all the points, even though it may go through none of them. The way we measure ‘closeness’ in this case is to find the **total squared error** between the data points and the line. Consider our three data points and the line $y = \frac{1}{2}x + \frac{1}{2}$. For each of our data points, we find the vertical distance between the point and the line. To accomplish this, we need to find a point on the line directly above or below each data point - in other words, a point on the line with the same x -coordinate as our data point. For example, to find the point on the line directly below $(1, 2)$, we plug $x = 1$ into $y = \frac{1}{2}x + \frac{1}{2}$ and we get the point $(1, 1)$. Similarly, we get $(3, 1)$ to correspond to $(3, 2)$ and $(4, \frac{5}{2})$ for $(4, 3)$.

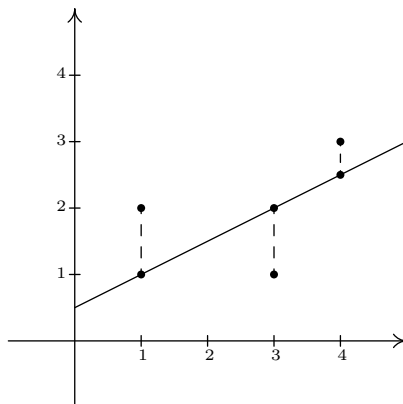

We find the total squared error E by taking the sum of the squares of the differences of the y -coordinates of each data point and its corresponding point on the line. For the data and line above $E = (2 - 1)^2 + (1 - 2)^2 + (3 - \frac{5}{2})^2 = \frac{9}{4}$. Using advanced mathematical machinery,² it is possible to find the line which results in the lowest value of E . This line is called the **least squares regression line**, or sometimes the ‘line of best fit’. The formula for the line of best fit requires notation for summation that we won’t see until much later. The graphing calculator can come to our assistance here, since it has a built-in feature to compute the regression line. We enter the data and perform the Linear Regression feature and we get

¹and authors with more expertise in this area,

²Like Calculus and Linear Algebra

L1	L2	L3	3
1	2	████████	
3	1		
4	3		

L3(1)=			

LinReg
y=ax+b
a=.2142857143
b=1.428571429
r ² =.1071428571
r=.3273268354

The calculator tells us that the line of best fit is $y = ax + b$ where the slope is $a \approx 0.214$ and the y -coordinate of the y -intercept is $b \approx 1.428$. (We will stick to using three decimal places for our approximations.) Using this line, we compute the total squared error for our data to be $E \approx 1.786$. The value r is the **correlation coefficient** and is a measure of how close the data is to being on the same line. The closer $|r|$ is to 1, the better the linear fit. Since $r \approx 0.327$, this tells us that the line of best fit doesn't fit all that well - in other words, our data points aren't close to being linear. The value r^2 is called the **coefficient of determination** and is also a measure of the goodness of fit.³ Plotting the data with its regression line results in the picture below.

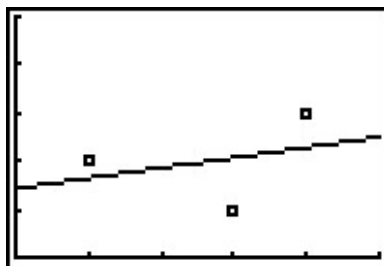

Our first example looks at energy consumption in the US over the past 50 years.⁴

Year	Energy Usage, in Quads ⁵
1950	34.6
1960	45.1
1970	67.8
1980	78.3
1990	84.6
2000	98.9

Example 2.5.1. Using the energy consumption data given above,

1. Plot the data using a graphing calculator.

³We refer the interested reader to a course in Statistics to explore the significance of r and r^2 .

⁴See this [Department of Energy](#) activity

⁵The unit 1 Quad is 1 Quadrillion = 10^{15} BTUs, which is enough heat to raise Lake Erie roughly 1°F

- Find the least squares regression line and comment on the goodness of fit.
- Interpret the slope of the line of best fit.
- Use the regression line to predict the annual US energy consumption in the year 2013.
- Use the regression line to predict when the annual consumption will reach 120 Quads.

Solution.

- Entering the data into the calculator gives

L1	L2	L3	3
1950	34.6		
1960	45.1		
1970	67.8		
1980	78.3		
1990	84.6		
2000	98.9		

L3(1)=			

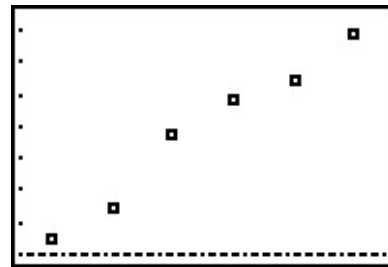

The data certainly appears to be linear in nature.

- Performing a linear regression produces

LinReg
y=ax+b
a=1.287142857
b=-2473.890476
r ² =.9741619014
r=.9869964039
■

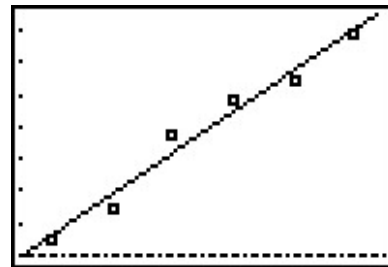

We can tell both from the correlation coefficient as well as the graph that the regression line is a good fit to the data.

- The slope of the regression line is $a \approx 1.287$. To interpret this, recall that the slope is the rate of change of the y -coordinates with respect to the x -coordinates. Since the y -coordinates represent the energy usage in Quads, and the x -coordinates represent years, a slope of positive 1.287 indicates an increase in annual energy usage at the rate of 1.287 Quads per year.
- To predict the energy needs in 2013, we substitute $x = 2013$ into the equation of the line of best fit to get $y = 1.287(2013) - 2473.890 \approx 116.841$. The predicted annual energy usage of the US in 2013 is approximately 116.841 Quads.

5. To predict when the annual US energy usage will reach 120 Quads, we substitute $y = 120$ into the equation of the line of best fit to get $120 = 1.287x - 2473.908$. Solving for x yields $x \approx 2015.454$. Since the regression line is increasing, we interpret this result as saying the annual usage in 2015 won't yet be 120 Quads, but that in 2016, the demand will be more than 120 Quads. \square

Our next example gives us an opportunity to find a nonlinear model to fit the data. According to the National Weather Service, the predicted hourly temperatures for Painesville on March 3, 2009 were given as summarized below.

Time	Temperature, °F
10AM	17
11AM	19
12PM	21
1PM	23
2PM	24
3PM	24
4PM	23

To enter this data into the calculator, we need to adjust the x values, since just entering the numbers could cause confusion. (Do you see why?) We have a few options available to us. Perhaps the easiest is to convert the times into the 24 hour clock time so that 1 PM is 13, 2 PM is 14, etc.. If we enter these data into the graphing calculator and plot the points we get

L1	L2	L3
10	17	█
11	19	
12	21	
13	23	
14	24	
15	24	
16	23	

L3(1)=

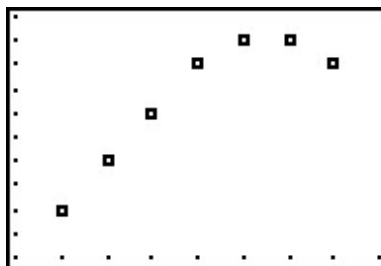

While the beginning of the data looks linear, the temperature begins to fall in the afternoon hours. This sort of behavior reminds us of parabolas, and, sure enough, it is possible to find a parabola of best fit in the same way we found a line of best fit. The process is called **quadratic regression** and its goal is to minimize the least square error of the data with their corresponding points on the parabola. The calculator has a built in feature for this as well which yields

```

QuadReg
y=ax2+bx+c
a=-.3214285714
b=9.464285714
c=-45.85714286
R2=.9836601307

```

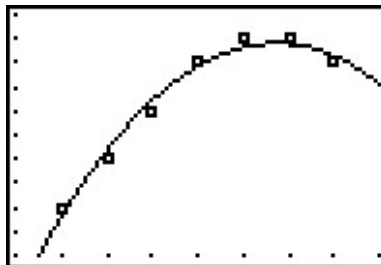

The coefficient of determination R^2 seems reasonably close to 1, and the graph visually seems to be a decent fit. We use this model in our next example.

Example 2.5.2. Using the quadratic model for the temperature data above, predict the warmest temperature of the day. When will this occur?

Solution. The maximum temperature will occur at the vertex of the parabola. Recalling the Vertex Formula, Equation 2.4, $x = -\frac{b}{2a} \approx -\frac{9.464}{2(-0.321)} \approx 14.741$. This corresponds to roughly 2:45 PM. To find the temperature, we substitute $x = 14.741$ into $y = -0.321x^2 + 9.464x - 45.857$ to get $y \approx 23.899$, or 23.899°F . \square

The results of the last example should remind you that regression models are just that, models. Our predicted warmest temperature was found to be 23.899°F , but our data says it will warm to 24°F . It's all well and good to observe trends and guess at a model, but a more thorough investigation into *why* certain data should be linear or quadratic in nature is usually in order - and that, most often, is the business of scientists.

2.5.1 EXERCISES

1. According to this [website](#)⁶, the census data for Lake County, Ohio is:

Year	1970	1980	1990	2000
Population	197200	212801	215499	227511

- Find the least squares regression line for these data and comment on the goodness of fit.⁷ Interpret the slope of the line of best fit.
 - Use the regression line to predict the population of Lake County in 2010. (The recorded figure from the 2010 census is 230,041)
 - Use the regression line to predict when the population of Lake County will reach 250,000.
2. According to this [website](#)⁸, the census data for Lorain County, Ohio is:

Year	1970	1980	1990	2000
Population	256843	274909	271126	284664

- Find the least squares regression line for these data and comment on the goodness of fit. Interpret the slope of the line of best fit.
 - Use the regression line to predict the population of Lorain County in 2010. (The recorded figure from the 2010 census is 301,356)
 - Use the regression line to predict when the population of Lake County will reach 325,000.
3. Using the energy production data given below

Year	1950	1960	1970	1980	1990	2000
Production (in Quads)	35.6	42.8	63.5	67.2	70.7	71.2

- Plot the data using a graphing calculator and explain why it does not appear to be linear.
- Discuss with your classmates why ignoring the first two data points may be justified from a historical perspective.
- Find the least squares regression line for the last four data points and comment on the goodness of fit. Interpret the slope of the line of best fit.
- Use the regression line to predict the annual US energy production in the year 2010.
- Use the regression line to predict when the annual US energy production will reach 100 Quads.

⁶<http://www.ohiobiz.com/census/Lake.pdf>

⁷We'll develop more sophisticated models for the growth of populations in Chapter 6. For the moment, we use a theorem from Calculus to approximate those functions with lines.

⁸<http://www.ohiobiz.com/census/Lorain.pdf>

4. The chart below contains a portion of the fuel consumption information for a 2002 Toyota Echo that I (Jeff) used to own. The first row is the cumulative number of gallons of gasoline that I had used and the second row is the odometer reading when I refilled the gas tank. So, for example, the fourth entry is the point (28.25, 1051) which says that I had used a total of 28.25 gallons of gasoline when the odometer read 1051 miles.

Gasoline Used (Gallons)	0	9.26	19.03	28.25	36.45	44.64	53.57	62.62	71.93	81.69	90.43
Odometer (Miles)	41	356	731	1051	1347	1631	1966	2310	2670	3030	3371

Find the least squares line for this data. Is it a good fit? What does the slope of the line represent? Do you and your classmates believe this model would have held for ten years had I not crashed the car on the Turnpike a few years ago? (I'm keeping a fuel log for my 2006 Scion xA for future College Algebra books so I hope not to crash it, too.)

5. On New Year's Day, I (Jeff, again) started weighing myself every morning in order to have an interesting data set for this section of the book. (Discuss with your classmates if that makes me a nerd or a geek. Also, the professionals in the field of weight management strongly discourage weighing yourself every day. When you focus on the number and not your overall health, you tend to lose sight of your objectives. I was making a noble sacrifice for science, but you should not try this at home.) The whole chart would be too big to put into the book neatly, so I've decided to give only a small portion of the data to you. This then becomes a Civics lesson in honesty, as you shall soon see. There are two charts given below. One has my weight for the first eight Thursdays of the year (January 1, 2009 was a Thursday and we'll count it as Day 1.) and the other has my weight for the first 10 Saturdays of the year.

Day # (Thursday)	1	8	15	22	29	36	43	50
My weight in pounds	238.2	237.0	235.6	234.4	233.0	233.8	232.8	232.0

Day # (Saturday)	3	10	17	24	31	38	45	52	59	66
My weight in pounds	238.4	235.8	235.0	234.2	236.2	236.2	235.2	233.2	236.8	238.2

- Find the least squares line for the Thursday data and comment on its goodness of fit.
- Find the least squares line for the Saturday data and comment on its goodness of fit.
- Use Quadratic Regression to find a parabola which models the Saturday data and comment on its goodness of fit.
- Compare and contrast the predictions the three models make for my weight on January 1, 2010 (Day #366). Can any of these models be used to make a prediction of my weight 20 years from now? Explain your answer.

- (e) Why is this a Civics lesson in honesty? Well, compare the two linear models you obtained above. One was a good fit and the other was not, yet both came from careful selections of real data. In presenting the tables to you, I have not lied about my weight, nor have you used any bad math to falsify the predictions. The word we're looking for here is 'disingenuous'. Look it up and then discuss the implications this type of data manipulation could have in a larger, more complex, politically motivated setting. (Even Obi-Wan presented the truth to Luke only "from a certain point of view.")
6. (Data that is neither linear nor quadratic.) We'll close this exercise set with two data sets that, for reasons presented later in the book, cannot be modeled correctly by lines or parabolas. It is a good exercise, though, to see what happens when you attempt to use a linear or quadratic model when it's not appropriate.
- (a) This first data set came from a Summer 2003 publication of the Portage County Animal Protective League called "Tattle Tails". They make the following statement and then have a chart of data that supports it. "It doesn't take long for two cats to turn into 80 million. If two cats and their surviving offspring reproduced for ten years, you'd end up with 80,399,780 cats." We assume $N(0) = 2$.

Year x	1	2	3	4	5	6	7	8	9	10
Number of Cats $N(x)$	12	66	382	2201	12680	73041	420715	2423316	13968290	80399780

Use Quadratic Regression to find a parabola which models this data and comment on its goodness of fit. (Spoiler Alert: Does anyone know what type of function we need here?)

- (b) This next data set comes from the [U.S. Naval Observatory](#). That site has loads of awesome stuff on it, but for this exercise I used the sunrise/sunset times in Fairbanks, Alaska for 2009 to give you a chart of the number of hours of daylight they get on the 21st of each month. We'll let $x = 1$ represent January 21, 2009, $x = 2$ represent February 21, 2009, and so on.

Month Number	1	2	3	4	5	6	7	8	9	10	11	12
Hours of Daylight	5.8	9.3	12.4	15.9	19.4	21.8	19.4	15.6	12.4	9.1	5.6	3.3

Use Quadratic Regression to find a parabola which models this data and comment on its goodness of fit. (Spoiler Alert: Does anyone know what type of function we need here?)

2.5.2 ANSWERS

1. (a) $y = 936.31x - 1645322.6$ with $r = 0.9696$ which indicates a good fit. The slope 936.31 indicates Lake County's population is increasing at a rate of (approximately) 936 people per year.
 - (b) According to the model, the population in 2010 will be 236,660.
 - (c) According to the model, the population of Lake County will reach 250,000 sometime between 2024 and 2025.
2. (a) $y = 796.8x - 1309762.5$ with $r = 0.8916$ which indicates a reasonable fit. The slope 796.8 indicates Lorain County's population is increasing at a rate of (approximately) 797 people per year.
 - (b) According to the model, the population in 2010 will be 291,805.
 - (c) According to the model, the population of Lake County will reach 325,000 sometime between 2051 and 2052.
3. (c) $y = 0.266x - 459.86$ with $r = 0.9607$ which indicates a good fit. The slope 0.266 indicates the country's energy production is increasing at a rate of 0.266 Quad per year.
 - (d) According to the model, the production in 2010 will be 74.8 Quad.
 - (e) According to the model, the production will reach 100 Quad in the year 2105.
4. The line is $y = 36.8x + 16.39$. We have $r = .99987$ and $r^2 = .9997$ so this is an excellent fit to the data. The slope 36.8 represents miles per gallon.
5. (a) The line for the Thursday data is $y = -.12x + 237.69$. We have $r = -.9568$ and $r^2 = .9155$ so this is a really good fit.
 - (b) The line for the Saturday data is $y = -0.000693x + 235.94$. We have $r = -0.008986$ and $r^2 = 0.0000807$ which is horrible. This data is not even close to linear.
 - (c) The parabola for the Saturday data is $y = 0.003x^2 - 0.21x + 238.30$. We have $R^2 = .47497$ which isn't good. Thus the data isn't modeled well by a quadratic function, either.
 - (d) The Thursday linear model had my weight on January 1, 2010 at 193.77 pounds. The Saturday models give 235.69 and 563.31 pounds, respectively. The Thursday line has my weight going below 0 pounds in about five and a half years, so that's no good. The quadratic has a positive leading coefficient which would mean unbounded weight gain for the rest of my life. The Saturday line, which mathematically does not fit the data at all, yields a plausible weight prediction in the end. I think this is why grown-ups talk about "Lies, Damned Lies and Statistics."
6. (a) The quadratic model for the cats in Portage county is $y = 1917803.54x^2 - 16036408.29x + 24094857.7$. Although $R^2 = .70888$ this is not a good model because it's so far off for small values of x . Case in point, the model gives us 24,094,858 cats when $x = 0$ but we know $N(0) = 2$.

- (b) The quadratic model for the hours of daylight in Fairbanks, Alaska is $y = .51x^2 + 6.23x - .36$. Even with $R^2 = .92295$ we should be wary of making predictions beyond the data. Case in point, the model gives -4.84 hours of daylight when $x = 13$. So January 21, 2010 will be “extra dark”? Obviously a parabola pointing down isn’t telling us the whole story.

CHAPTER 3

POLYNOMIAL FUNCTIONS

3.1 GRAPHS OF POLYNOMIALS

Three of the families of functions studied thus far – constant, linear and quadratic – belong to a much larger group of functions called **polynomials**. We begin our formal study of general polynomials with a definition and some examples.

Definition 3.1. A **polynomial function** is a function of the form

$$f(x) = a_n x^n + a_{n-1} x^{n-1} + \dots + a_2 x^2 + a_1 x + a_0,$$

where a_0, a_1, \dots, a_n are real numbers and $n \geq 1$ is a natural number. The domain of a polynomial function is $(-\infty, \infty)$.

There are several things about Definition 3.1 that may be off-putting or downright frightening. The best thing to do is look at an example. Consider $f(x) = 4x^5 - 3x^2 + 2x - 5$. Is this a polynomial function? We can re-write the formula for f as $f(x) = 4x^5 + 0x^4 + 0x^3 + (-3)x^2 + 2x + (-5)$. Comparing this with Definition 3.1, we identify $n = 5$, $a_5 = 4$, $a_4 = 0$, $a_3 = 0$, $a_2 = -3$, $a_1 = 2$ and $a_0 = -5$. In other words, a_5 is the coefficient of x^5 , a_4 is the coefficient of x^4 , and so forth; the subscript on the a 's merely indicates to which power of x the coefficient belongs. The business of restricting n to be a natural number lets us focus on well-behaved algebraic animals.¹

Example 3.1.1. Determine if the following functions are polynomials. Explain your reasoning.

1. $g(x) = \frac{4 + x^3}{x}$

2. $p(x) = \frac{4x + x^3}{x}$

3. $q(x) = \frac{4x + x^3}{x^2 + 4}$

4. $f(x) = \sqrt[3]{x}$

5. $h(x) = |x|$

6. $z(x) = 0$

¹Enjoy this while it lasts. Before we're through with the book, you'll have been exposed to the most terrible of algebraic beasts. We will tame them all, in time.

Solution.

1. We note directly that the domain of $g(x) = \frac{x^3+4}{x}$ is $x \neq 0$. By definition, a polynomial has all real numbers as its domain. Hence, g can't be a polynomial.
2. Even though $p(x) = \frac{x^3+4x}{x}$ simplifies to $p(x) = x^2 + 4$, which certainly looks like the form given in Definition 3.1, the domain of p , which, as you may recall, we determine *before* we simplify, excludes 0. Alas, p is not a polynomial function for the same reason g isn't.
3. After what happened with p in the previous part, you may be a little shy about simplifying $q(x) = \frac{x^3+4x}{x^2+4}$ to $q(x) = x$, which certainly fits Definition 3.1. If we look at the domain of q before we simplified, we see that it is, indeed, all real numbers. A function which can be written in the form of Definition 3.1 whose domain is all real numbers is, in fact, a polynomial.
4. We can rewrite $f(x) = \sqrt[3]{x}$ as $f(x) = x^{\frac{1}{3}}$. Since $\frac{1}{3}$ is not a natural number, f is not a polynomial.
5. The function $h(x) = |x|$ isn't a polynomial, since it can't be written as a combination of powers of x even though it can be written as a piecewise function involving polynomials. As we shall see in this section, graphs of polynomials possess a quality² that the graph of h does not.
6. There's nothing in Definition 3.1 which prevents all the coefficients a_n , etc., from being 0. Hence, $z(x) = 0$, is an honest-to-goodness polynomial.

Definition 3.2. Suppose f is a polynomial function.

- Given $f(x) = a_n x^n + a_{n-1} x^{n-1} + \dots + a_2 x^2 + a_1 x + a_0$ with $a_n \neq 0$, we say
 - The natural number n is called the **degree** of the polynomial f .
 - The term $a_n x^n$ is called the **leading term** of the polynomial f .
 - The real number a_n is called the **leading coefficient** of the polynomial f .
 - The real number a_0 is called the **constant term** of the polynomial f .
- If $f(x) = a_0$, and $a_0 \neq 0$, we say f has degree 0.
- If $f(x) = 0$, we say f has no degree.^a

^aSome authors say $f(x) = 0$ has degree $-\infty$ for reasons not even we will go into.

The reader may well wonder why we have chosen to separate off constant functions from the other polynomials in Definition 3.2. Why not just lump them all together and, instead of forcing n to be a natural number, $n = 1, 2, \dots$, allow n to be a whole number, $n = 0, 1, 2, \dots$. We could unify all

²One which really relies on Calculus to verify.

of the cases, since, after all, isn't $a_0x^0 = a_0$? The answer is 'yes, as long as $x \neq 0$.' The function $f(x) = 3$ and $g(x) = 3x^0$ are different, because their domains are different. The number $f(0) = 3$ is defined, whereas $g(0) = 3(0)^0$ is not.³ Indeed, much of the theory we will develop in this chapter doesn't include the constant functions, so we might as well treat them as outsiders from the start. One good thing that comes from Definition 3.2 is that we can now think of linear functions as degree 1 (or 'first degree') polynomial functions and quadratic functions as degree 2 (or 'second degree') polynomial functions.

Example 3.1.2. Find the degree, leading term, leading coefficient and constant term of the following polynomial functions.

1. $f(x) = 4x^5 - 3x^2 + 2x - 5$

2. $g(x) = 12x + x^3$

3. $h(x) = \frac{4-x}{5}$

4. $p(x) = (2x-1)^3(x-2)(3x+2)$

Solution.

1. There are no surprises with $f(x) = 4x^5 - 3x^2 + 2x - 5$. It is written in the form of Definition 3.2, and we see that the degree is 5, the leading term is $4x^5$, the leading coefficient is 4 and the constant term is -5 .
2. The form given in Definition 3.2 has the highest power of x first. To that end, we re-write $g(x) = 12x + x^3 = x^3 + 12x$, and see that the degree of g is 3, the leading term is x^3 , the leading coefficient is 1 and the constant term is 0.
3. We need to rewrite the formula for h so that it resembles the form given in Definition 3.2: $h(x) = \frac{4-x}{5} = \frac{4}{5} - \frac{x}{5} = -\frac{1}{5}x + \frac{4}{5}$. The degree of h is 1, the leading term is $-\frac{1}{5}x$, the leading coefficient is $-\frac{1}{5}$ and the constant term is $\frac{4}{5}$.
4. It may seem that we have some work ahead of us to get p in the form of Definition 3.2. However, it is possible to glean the information requested about p without multiplying out the entire expression $(2x-1)^3(x-2)(3x+2)$. The leading term of p will be the term which has the highest power of x . The way to get this term is to multiply the terms with the highest power of x from each factor together - in other words, the leading term of $p(x)$ is the product of the leading terms of the factors of $p(x)$. Hence, the leading term of p is $(2x)^3(x)(3x) = 24x^5$. This means that the degree of p is 5 and the leading coefficient is 24. As for the constant term, we can perform a similar trick. The constant term is obtained by multiplying the constant terms from each of the factors $(-1)^3(-2)(2) = 4$. \square

Our next example shows how polynomials of higher degree arise 'naturally'⁴ in even the most basic geometric applications.

³Technically, 0^0 is an indeterminate form, which is a special case of being undefined. The authors realize this is beyond pedantry, but we wouldn't mention it if we didn't feel it was necessary.

⁴this is a dangerous word...

Example 3.1.3. A box with no top is to be fashioned from a 10 inch \times 12 inch piece of cardboard by cutting out congruent squares from each corner of the cardboard and then folding the resulting tabs. Let x denote the length of the side of the square which is removed from each corner.

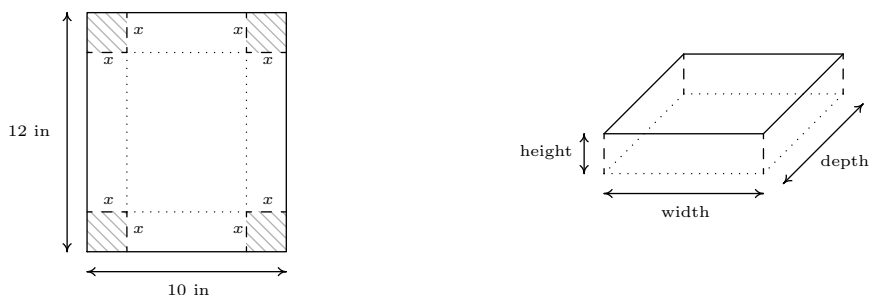

1. Find the volume V of the box as a function of x . Include an appropriate applied domain.
2. Use a graphing calculator to graph $y = V(x)$ on the domain you found in part 1 and approximate the dimensions of the box with maximum volume to two decimal places. What is the maximum volume?

Solution.

1. From Geometry, we know that Volume = width \times height \times depth. The key is to find each of these quantities in terms of x . From the figure, we see that the height of the box is x itself. The cardboard piece is initially 10 inches wide. Removing squares with a side length of x inches from each corner leaves $10 - 2x$ inches for the width.⁵ As for the depth, the cardboard is initially 12 inches long, so after cutting out x inches from each side, we would have $12 - 2x$ inches remaining. As a function⁶ of x , the volume is

$$V(x) = x(10 - 2x)(12 - 2x) = 4x^3 - 44x^2 + 120x$$

To find a suitable applied domain, we note that to make a box at all we need $x > 0$. Also the shorter of the two dimensions of the cardboard is 10 inches, and since we are removing $2x$ inches from this dimension, we also require $10 - 2x > 0$ or $x < 5$. Hence, our applied domain is $0 < x < 5$.

2. Using a graphing calculator, we see that the graph of $y = V(x)$ has a relative maximum. For $0 < x < 5$, this is also the absolute maximum. Using the 'Maximum' feature of the calculator, we get $x \approx 1.81$, $y \approx 96.77$. This yields a height of $x \approx 1.81$ inches, a width of $10 - 2x \approx 6.38$ inches, and a depth of $12 - 2x \approx 8.38$ inches. The y -coordinate is the maximum volume, which is approximately 96.77 cubic inches (also written in³).

⁵There's no harm in taking an extra step here and making sure this makes sense. If we chopped out a 1 inch square from each side, then the width would be 8 inches, so chopping out x inches would leave $10 - 2x$ inches.

⁶When we write $V(x)$, it is in the context of function notation, not the volume V times the quantity x .

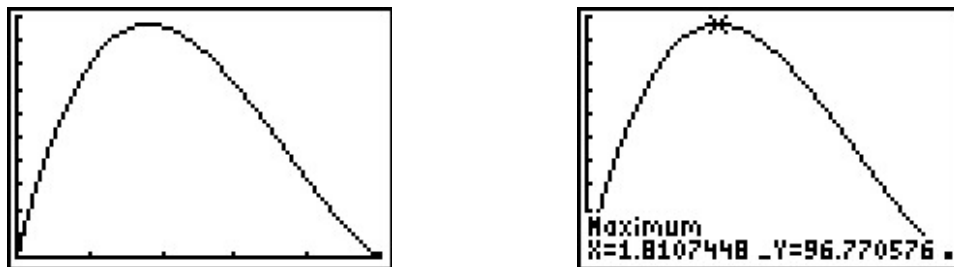

In order to solve Example 3.1.3, we made good use of the graph of the polynomial $y = V(x)$, so we ought to turn our attention to graphs of polynomials in general. Below are the graphs of $y = x^2$, $y = x^4$ and $y = x^6$, side-by-side. We have omitted the axes to allow you to see that as the exponent increases, the ‘bottom’ becomes ‘flatter’ and the ‘sides’ become ‘steeper.’ If you take the time to graph these functions by hand,⁷ you will see why.

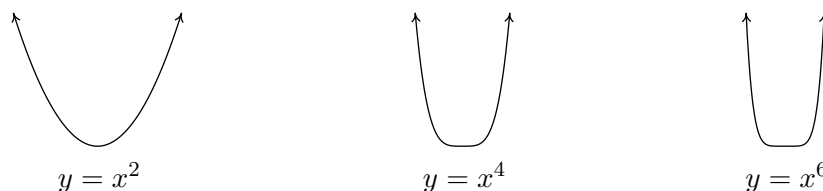

All of these functions are even, (Do you remember how to show this?) and it is exactly because the exponent is even.⁸ This symmetry is important, but we want to explore a different yet equally important feature of these functions which we can be seen graphically – their **end behavior**.

The end behavior of a function is a way to describe what is happening to the function values (the y -values) as the x -values approach the ‘ends’ of the x -axis.⁹ That is, what happens to y as x becomes small without bound¹⁰ (written $x \rightarrow -\infty$) and, on the flip side, as x becomes large without bound¹¹ (written $x \rightarrow \infty$).

For example, given $f(x) = x^2$, as $x \rightarrow -\infty$, we imagine substituting $x = -100$, $x = -1000$, etc., into f to get $f(-100) = 10000$, $f(-1000) = 1000000$, and so on. Thus the function values are becoming larger and larger positive numbers (without bound). To describe this behavior, we write: as $x \rightarrow -\infty$, $f(x) \rightarrow \infty$. If we study the behavior of f as $x \rightarrow \infty$, we see that in this case, too, $f(x) \rightarrow \infty$. (We told you that the symmetry was important!) The same can be said for any function of the form $f(x) = x^n$ where n is an even natural number. If we generalize just a bit to include vertical scalings and reflections across the x -axis,¹² we have

⁷Make sure you choose some x -values between -1 and 1 .

⁸Herein lies one of the possible origins of the term ‘even’ when applied to functions.

⁹Of course, there are no ends to the x -axis.

¹⁰We think of x as becoming a very large (in the sense of its absolute value) *negative* number far to the left of zero.

¹¹We think of x as moving far to the right of zero and becoming a very large *positive* number.

¹²See Theorems 1.4 and 1.5 in Section 1.7.

End Behavior of functions $f(x) = ax^n$, n even.

Suppose $f(x) = ax^n$ where $a \neq 0$ is a real number and n is an even natural number. The end behavior of the graph of $y = f(x)$ matches one of the following:

- for $a > 0$, as $x \rightarrow -\infty$, $f(x) \rightarrow \infty$ and as $x \rightarrow \infty$, $f(x) \rightarrow \infty$
- for $a < 0$, as $x \rightarrow -\infty$, $f(x) \rightarrow -\infty$ and as $x \rightarrow \infty$, $f(x) \rightarrow -\infty$

Graphically:

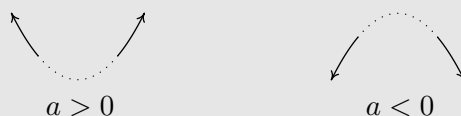

We now turn our attention to functions of the form $f(x) = x^n$ where $n \geq 3$ is an odd natural number. (We ignore the case when $n = 1$, since the graph of $f(x) = x$ is a line and doesn't fit the general pattern of higher-degree odd polynomials.) Below we have graphed $y = x^3$, $y = x^5$, and $y = x^7$. The 'flattening' and 'steepening' that we saw with the even powers presents itself here as well, and, it should come as no surprise that all of these functions are odd.¹³ The end behavior of these functions is all the same, with $f(x) \rightarrow -\infty$ as $x \rightarrow -\infty$ and $f(x) \rightarrow \infty$ as $x \rightarrow \infty$.

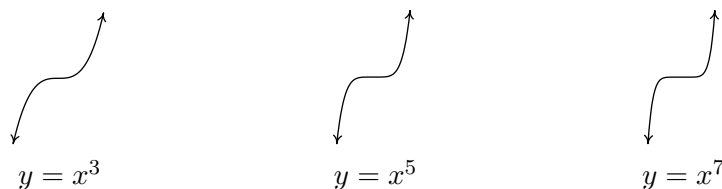

As with the even degreed functions we studied earlier, we can generalize their end behavior.

End Behavior of functions $f(x) = ax^n$, n odd.

Suppose $f(x) = ax^n$ where $a \neq 0$ is a real number and $n \geq 3$ is an odd natural number. The end behavior of the graph of $y = f(x)$ matches one of the following:

- for $a > 0$, as $x \rightarrow -\infty$, $f(x) \rightarrow -\infty$ and as $x \rightarrow \infty$, $f(x) \rightarrow \infty$
- for $a < 0$, as $x \rightarrow -\infty$, $f(x) \rightarrow \infty$ and as $x \rightarrow \infty$, $f(x) \rightarrow -\infty$

Graphically:

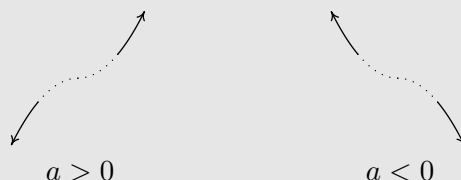

¹³And are, perhaps, the inspiration for the moniker 'odd function'.

Despite having different end behavior, all functions of the form $f(x) = ax^n$ for natural numbers n share two properties which help distinguish them from other animals in the algebra zoo: they are **continuous** and **smooth**. While these concepts are formally defined using Calculus,¹⁴ informally, graphs of continuous functions have no ‘breaks’ or ‘holes’ in them, and the graphs of smooth functions have no ‘sharp turns’. It turns out that these traits are preserved when functions are added together, so general polynomial functions inherit these qualities. Below we find the graph of a function which is neither smooth nor continuous, and to its right we have a graph of a polynomial, for comparison. The function whose graph appears on the left fails to be continuous where it has a ‘break’ or ‘hole’ in the graph; everywhere else, the function is continuous. The function is continuous at the ‘corner’ and the ‘cusp’, but we consider these ‘sharp turns’, so these are places where the function fails to be smooth. Apart from these four places, the function is smooth and continuous. Polynomial functions are smooth and continuous everywhere, as exhibited in the graph on the right.

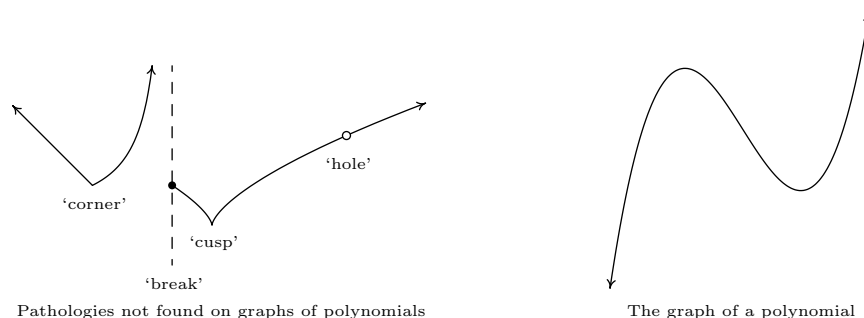

The notion of smoothness is what tells us graphically that, for example, $f(x) = |x|$, whose graph is the characteristic ‘V’ shape, cannot be a polynomial. The notion of continuity is what allowed us to construct the sign diagram for quadratic inequalities as we did in Section 2.4. This last result is formalized in the following theorem.

Theorem 3.1. The Intermediate Value Theorem (Zero Version): Suppose f is a continuous function on an interval containing $x = a$ and $x = b$ with $a < b$. If $f(a)$ and $f(b)$ have different signs, then f has at least one zero between $x = a$ and $x = b$; that is, for at least one real number c such that $a < c < b$, we have $f(c) = 0$.

The Intermediate Value Theorem is extremely profound; it gets to the heart of what it means to be a real number, and is one of the most often used and under appreciated theorems in Mathematics. With that being said, most students see the result as common sense since it says, geometrically, that the graph of a polynomial function cannot be above the x -axis at one point and below the x -axis at another point without crossing the x -axis somewhere in between. The following example uses the Intermediate Value Theorem to establish a fact that most students take for granted. Many students, and sadly some instructors, will find it silly.

¹⁴In fact, if you take Calculus, you’ll find that smooth functions are automatically continuous, so that saying ‘polynomials are continuous and smooth’ is redundant.

Example 3.1.4. Use the Intermediate Value Theorem to establish that $\sqrt{2}$ is a real number.

Solution. Consider the polynomial function $f(x) = x^2 - 2$. Then $f(1) = -1$ and $f(3) = 7$. Since $f(1)$ and $f(3)$ have different signs, the Intermediate Value Theorem guarantees us a real number c between 1 and 3 with $f(c) = 0$. If $c^2 - 2 = 0$ then $c = \pm\sqrt{2}$. Since c is between 1 and 3, c is positive, so $c = \sqrt{2}$. \square

Our primary use of the Intermediate Value Theorem is in the construction of sign diagrams, as in Section 2.4, since it guarantees us that polynomial functions are always positive (+) or always negative (-) on intervals which do not contain any of its zeros. The general algorithm for polynomials is given below.

Steps for Constructing a Sign Diagram for a Polynomial Function

Suppose f is a polynomial function.

1. Find the zeros of f and place them on the number line with the number 0 above them.
2. Choose a real number, called a **test value**, in each of the intervals determined in step 1.
3. Determine the sign of $f(x)$ for each test value in step 2, and write that sign above the corresponding interval.

Example 3.1.5. Construct a sign diagram for $f(x) = x^3(x - 3)^2(x + 2)(x^2 + 1)$. Use it to give a rough sketch of the graph of $y = f(x)$.

Solution. First, we find the zeros of f by solving $x^3(x - 3)^2(x + 2)(x^2 + 1) = 0$. We get $x = 0$, $x = 3$ and $x = -2$. (The equation $x^2 + 1 = 0$ produces no real solutions.) These three points divide the real number line into four intervals: $(-\infty, -2)$, $(-2, 0)$, $(0, 3)$ and $(3, \infty)$. We select the test values $x = -3$, $x = -1$, $x = 1$ and $x = 4$. We find $f(-3)$ is (+), $f(-1)$ is (-) and $f(1)$ is (+) as is $f(4)$. Wherever f is (+), its graph is above the x -axis; wherever f is (-), its graph is below the x -axis. The x -intercepts of the graph of f are $(-2, 0)$, $(0, 0)$ and $(3, 0)$. Knowing f is smooth and continuous allows us to sketch its graph.

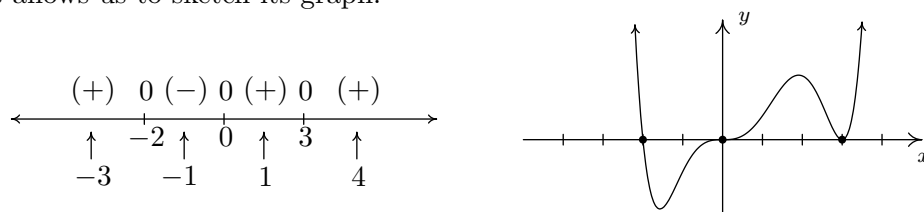

A sketch of $y = f(x)$ \square

A couple of notes about the Example 3.1.5 are in order. First, note that we purposefully did not label the y -axis in the sketch of the graph of $y = f(x)$. This is because the sign diagram gives us the zeros and the relative position of the graph - it doesn't give us any information as to how high or low the graph strays from the x -axis. Furthermore, as we have mentioned earlier in the text, without Calculus, the values of the relative maximum and minimum can only be found approximately using a calculator. If we took the time to find the leading term of f , we would find it to be x^8 . Looking

at the end behavior of f , we notice that it matches the end behavior of $y = x^3$. This is no accident, as we find out in the next theorem.

Theorem 3.2. End Behavior for Polynomial Functions: The end behavior of a polynomial $f(x) = a_nx^n + a_{n-1}x^{n-1} + \dots + a_2x^2 + a_1x + a_0$ with $a_n \neq 0$ matches the end behavior of $y = a_nx^n$.

To see why Theorem 3.2 is true, let's first look at a specific example. Consider $f(x) = 4x^3 - x + 5$. If we wish to examine end behavior, we look to see the behavior of f as $x \rightarrow \pm\infty$. Since we're concerned with x 's far down the x -axis, we are far away from $x = 0$ so can rewrite $f(x)$ for these values of x as

$$f(x) = 4x^3 \left(1 - \frac{1}{4x^2} + \frac{5}{4x^3} \right)$$

As x becomes unbounded (in either direction), the terms $\frac{1}{4x^2}$ and $\frac{5}{4x^3}$ become closer and closer to 0, as the table below indicates.

x	$\frac{1}{4x^2}$	$\frac{5}{4x^3}$
-1000	0.00000025	-0.00000000125
-100	0.000025	-0.00000125
-10	0.0025	-0.00125
10	0.0025	0.00125
100	0.000025	0.00000125
1000	0.00000025	0.00000000125

In other words, as $x \rightarrow \pm\infty$, $f(x) \approx 4x^3(1 - 0 + 0) = 4x^3$, which is the leading term of f . The formal proof of Theorem 3.2 works in much the same way. Factoring out the leading term leaves

$$f(x) = a_nx^n \left(1 + \frac{a_{n-1}}{a_nx} + \dots + \frac{a_2}{a_nx^{n-2}} + \frac{a_1}{a_nx^{n-1}} + \frac{a_0}{a_nx^n} \right)$$

As $x \rightarrow \pm\infty$, any term with an x in the denominator becomes closer and closer to 0, and we have $f(x) \approx a_nx^n$. Geometrically, Theorem 3.2 says that if we graph $y = f(x)$ using a graphing calculator, and continue to 'zoom out', the graph of it and its leading term become indistinguishable. Below are the graphs of $y = 4x^3 - x + 5$ (the thicker line) and $y = 4x^3$ (the thinner line) in two different windows.



A view 'close' to the origin.

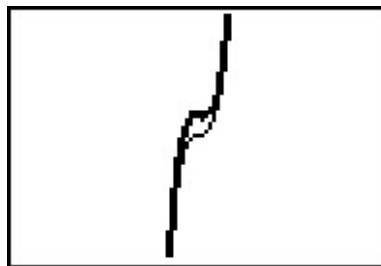

A 'zoomed out' view.

Let's return to the function in Example 3.1.5, $f(x) = x^3(x-3)^2(x+2)(x^2+1)$, whose sign diagram and graph are reproduced below for reference. Theorem 3.2 tells us that the end behavior is the same as that of its leading term x^8 . This tells us that the graph of $y = f(x)$ starts and ends above the x -axis. In other words, $f(x)$ is (+) as $x \rightarrow \pm\infty$, and as a result, we no longer need to evaluate f at the test values $x = -3$ and $x = 4$. Is there a way to eliminate the need to evaluate f at the other test values? What we would really need to know is how the function behaves near its zeros - does it cross through the x -axis at these points, as it does at $x = -2$ and $x = 0$, or does it simply touch and rebound like it does at $x = 3$. From the sign diagram, the graph of f will cross the x -axis whenever the signs on either side of the zero switch (like they do at $x = -2$ and $x = 0$); it will touch when the signs are the same on either side of the zero (as is the case with $x = 3$). What we need to determine is the reason behind whether or not the sign change occurs.

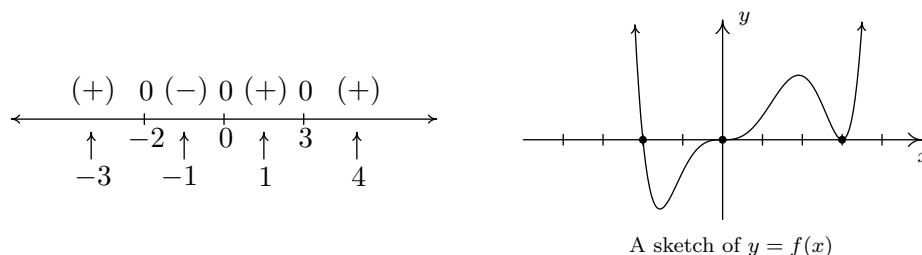

Fortunately, f was given to us in factored form: $f(x) = x^3(x-3)^2(x+2)$. When we attempt to determine the sign of $f(-4)$, we are attempting to find the sign of the number $(-4)^3(-7)^2(-2)$, which works out to be $(-)(+)(-)$ which is (+). If we move to the other side of $x = -2$, and find the sign of $f(-1)$, we are determining the sign of $(-1)^3(-4)^2(+1)$, which is $(-)(+)(+)$ which gives us the (-). Notice that signs of the first two factors in both expressions are the same in $f(-4)$ and $f(-1)$. The only factor which switches sign is the third factor, $(x+2)$, precisely the factor which gave us the zero $x = -2$. If we move to the other side of 0 and look closely at $f(1)$, we get the sign pattern $(+1)^3(-2)^2(+3)$ or $(+)(+)(+)$ and we note that, once again, going from $f(-1)$ to $f(1)$, the only factor which changed sign was the first factor, x^3 , which corresponds to the zero $x = 0$. Finally, to find $f(4)$, we substitute to get $(+4)^3(+2)^2(+5)$ which is $(+)(+)(+)$ or (+). The sign didn't change for the middle factor $(x-3)^2$. Even though this is the factor which corresponds to the zero $x = 3$, the fact that the quantity is *squared* kept the sign of the middle factor the same on either side of 3. If we look back at the exponents on the factors $(x+2)$ and x^3 , we see that they are both odd, so as we substitute values to the left and right of the corresponding zeros, the signs of the corresponding factors change which results in the sign of the function value changing. This is the key to the behavior of the function near the zeros. We need a definition and then a theorem.

Definition 3.3. Suppose f is a polynomial function and m is a natural number. If $(x-c)^m$ is a factor of $f(x)$ but $(x-c)^{m+1}$ is not, then we say $x=c$ is a zero of **multiplicity** m .

Hence, rewriting $f(x) = x^3(x-3)^2(x+2)$ as $f(x) = (x-0)^3(x-3)^2(x-(-2))^1$, we see that $x=0$ is a zero of multiplicity 3, $x=3$ is a zero of multiplicity 2 and $x=-2$ is a zero of multiplicity 1.

Theorem 3.3. The Role of Multiplicity: Suppose f is a polynomial function and $x = c$ is a zero of multiplicity m .

- If m is even, the graph of $y = f(x)$ touches and rebounds from the x -axis at $(c, 0)$.
- If m is odd, the graph of $y = f(x)$ crosses through the x -axis at $(c, 0)$.

Our last example shows how end behavior and multiplicity allow us to sketch a decent graph without appealing to a sign diagram.

Example 3.1.6. Sketch the graph of $f(x) = -3(2x - 1)(x + 1)^2$ using end behavior and the multiplicity of its zeros.

Solution. The end behavior of the graph of f will match that of its leading term. To find the leading term, we multiply by the leading terms of each factor to get $(-3)(2x)(x)^2 = -6x^3$. This tells us that the graph will start above the x -axis, in Quadrant II, and finish below the x -axis, in Quadrant IV. Next, we find the zeros of f . Fortunately for us, f is factored.¹⁵ Setting each factor equal to zero gives us $x = \frac{1}{2}$ and $x = -1$ as zeros. To find the multiplicity of $x = \frac{1}{2}$ we note that it corresponds to the factor $(2x - 1)$. This isn't strictly in the form required in Definition 3.3. If we factor out the 2, however, we get $(2x - 1) = 2(x - \frac{1}{2})$, and we see that the multiplicity of $x = \frac{1}{2}$ is 1. Since 1 is an odd number, we know from Theorem 3.3 that the graph of f will cross through the x -axis at $(\frac{1}{2}, 0)$. Since the zero $x = -1$ corresponds to the factor $(x + 1)^2 = (x - (-1))^2$, we find its multiplicity to be 2 which is an even number. As such, the graph of f will touch and rebound from the x -axis at $(-1, 0)$. Though we're not asked to, we can find the y -intercept by finding $f(0) = -3(2(0) - 1)(0 + 1)^2 = 3$. Thus $(0, 3)$ is an additional point on the graph. Putting this together gives us the graph below.

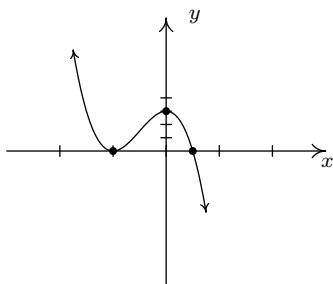

□

¹⁵Obtaining the factored form of a polynomial is the main focus of the next few sections.

3.1.1 EXERCISES

In Exercises 1 - 10, find the degree, the leading term, the leading coefficient, the constant term and the end behavior of the given polynomial.

1. $f(x) = 4 - x - 3x^2$

2. $g(x) = 3x^5 - 2x^2 + x + 1$

3. $q(r) = 1 - 16r^4$

4. $Z(b) = 42b - b^3$

5. $f(x) = \sqrt{3}x^{17} + 22.5x^{10} - \pi x^7 + \frac{1}{3}$

6. $s(t) = -4.9t^2 + v_0t + s_0$

7. $P(x) = (x - 1)(x - 2)(x - 3)(x - 4)$

8. $p(t) = -t^2(3 - 5t)(t^2 + t + 4)$

9. $f(x) = -2x^3(x + 1)(x + 2)^2$

10. $G(t) = 4(t - 2)^2(t + \frac{1}{2})$

In Exercises 11 - 20, find the real zeros of the given polynomial and their corresponding multiplicities. Use this information along with a sign chart to provide a rough sketch of the graph of the polynomial. Compare your answer with the result from a graphing utility.

11. $a(x) = x(x + 2)^2$

12. $g(x) = x(x + 2)^3$

13. $f(x) = -2(x - 2)^2(x + 1)$

14. $g(x) = (2x + 1)^2(x - 3)$

15. $F(x) = x^3(x + 2)^2$

16. $P(x) = (x - 1)(x - 2)(x - 3)(x - 4)$

17. $Q(x) = (x + 5)^2(x - 3)^4$

18. $h(x) = x^2(x - 2)^2(x + 2)^2$

19. $H(t) = (3 - t)(t^2 + 1)$

20. $Z(b) = b(42 - b^2)$

In Exercises 21 - 26, given the pair of functions f and g , sketch the graph of $y = g(x)$ by starting with the graph of $y = f(x)$ and using transformations. Track at least three points of your choice through the transformations. State the domain and range of g .

21. $f(x) = x^3, g(x) = (x + 2)^3 + 1$

22. $f(x) = x^4, g(x) = (x + 2)^4 + 1$

23. $f(x) = x^4, g(x) = 2 - 3(x - 1)^4$

24. $f(x) = x^5, g(x) = -x^5 - 3$

25. $f(x) = x^5, g(x) = (x + 1)^5 + 10$

26. $f(x) = x^6, g(x) = 8 - x^6$

27. Use the Intermediate Value Theorem to prove that $f(x) = x^3 - 9x + 5$ has a real zero in each of the following intervals: $[-4, -3]$, $[0, 1]$ and $[2, 3]$.

28. Rework Example 3.1.3 assuming the box is to be made from an 8.5 inch by 11 inch sheet of paper. Using scissors and tape, construct the box. Are you surprised?¹⁶

¹⁶Consider decorating the box and presenting it to your instructor. If done well enough, maybe your instructor will issue you some bonus points. Or maybe not.

In Exercises 29 - 31, suppose the revenue R , in *thousands* of dollars, from producing and selling x *hundred* LCD TVs is given by $R(x) = -5x^3 + 35x^2 + 155x$ for $0 \leq x \leq 10.07$.

29. Use a graphing utility to graph $y = R(x)$ and determine the number of TVs which should be sold to maximize revenue. What is the maximum revenue?
30. Assume that the cost, in *thousands* of dollars, to produce x *hundred* LCD TVs is given by $C(x) = 200x + 25$ for $x \geq 0$. Find and simplify an expression for the profit function $P(x)$. (Remember: Profit = Revenue - Cost.)
31. Use a graphing utility to graph $y = P(x)$ and determine the number of TVs which should be sold to maximize profit. What is the maximum profit?
32. While developing their newest game, Sasquatch Attack!, the makers of the PortaBoy (from Example 2.1.5) revised their cost function and now use $C(x) = .03x^3 - 4.5x^2 + 225x + 250$, for $x \geq 0$. As before, $C(x)$ is the cost to make x PortaBoy Game Systems. Market research indicates that the demand function $p(x) = -1.5x + 250$ remains unchanged. Use a graphing utility to find the production level x that maximizes the *profit* made by producing and selling x PortaBoy game systems.
33. According to US Postal regulations, a rectangular shipping box must satisfy the inequality “Length + Girth \leq 130 inches” for Parcel Post and “Length + Girth \leq 108 inches” for other services. Let’s assume we have a closed rectangular box with a square face of side length x as drawn below. The length is the longest side and is clearly labeled. The girth is the distance around the box in the other two dimensions so in our case it is the sum of the four sides of the square, $4x$.
 - (a) Assuming that we’ll be mailing a box via Parcel Post where Length + Girth = 130 inches, express the length of the box in terms of x and then express the volume V of the box in terms of x .
 - (b) Find the dimensions of the box of maximum volume that can be shipped via Parcel Post.
 - (c) Repeat parts 33a and 33b if the box is shipped using “other services”.

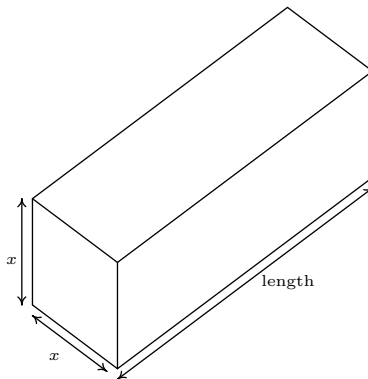

34. We now revisit the data set from Exercise 6b in Section 2.5. In that exercise, you were given a chart of the number of hours of daylight they get on the 21st of each month in Fairbanks, Alaska based on the 2009 sunrise and sunset data found on the [U.S. Naval Observatory](#) website. We let $x = 1$ represent January 21, 2009, $x = 2$ represent February 21, 2009, and so on. The chart is given again for reference.

Month Number	1	2	3	4	5	6	7	8	9	10	11	12
Hours of Daylight	5.8	9.3	12.4	15.9	19.4	21.8	19.4	15.6	12.4	9.1	5.6	3.3

Find cubic (third degree) and quartic (fourth degree) polynomials which model this data and comment on the goodness of fit for each. What can we say about using either model to make predictions about the year 2020? (Hint: Think about the end behavior of polynomials.) Use the models to see how many hours of daylight they got on your birthday and then check the website to see how accurate the models are. Knowing that Sasquatch are largely nocturnal, what days of the year according to your models are going to allow for at least 14 hours of darkness for field research on the elusive creatures?

35. An electric circuit is built with a variable resistor installed. For each of the following resistance values (measured in kilo-ohms, $k\Omega$), the corresponding power to the load (measured in milliwatts, mW) is given in the table below. ¹⁷

Resistance: ($k\Omega$)	1.012	2.199	3.275	4.676	6.805	9.975
Power: (mW)	1.063	1.496	1.610	1.613	1.505	1.314

- Make a scatter diagram of the data using the Resistance as the independent variable and Power as the dependent variable.
 - Use your calculator to find quadratic (2nd degree), cubic (3rd degree) and quartic (4th degree) regression models for the data and judge the reasonableness of each.
 - For each of the models found above, find the predicted maximum power that can be delivered to the load. What is the corresponding resistance value?
 - Discuss with your classmates the limitations of these models - in particular, discuss the end behavior of each.
36. Show that the end behavior of a linear function $f(x) = mx + b$ is as it should be according to the results we've established in the section for polynomials of odd degree.¹⁸ (That is, show that the graph of a linear function is "up on one side and down on the other" just like the graph of $y = a_n x^n$ for odd numbers n .)

¹⁷The authors wish to thank Don Anthan and Ken White of Lakeland Community College for devising this problem and generating the accompanying data set.

¹⁸Remember, to be a linear function, $m \neq 0$.

37. There is one subtlety about the role of multiplicity that we need to discuss further; specifically we need to see ‘how’ the graph crosses the x -axis at a zero of odd multiplicity. In the section, we deliberately excluded the function $f(x) = x$ from the discussion of the end behavior of $f(x) = x^n$ for odd numbers n and we said at the time that it was due to the fact that $f(x) = x$ didn’t fit the pattern we were trying to establish. You just showed in the previous exercise that the end behavior of a linear function behaves like every other polynomial of odd degree, so what doesn’t $f(x) = x$ do that $g(x) = x^3$ does? It’s the ‘flattening’ for values of x near zero. It is this local behavior that will distinguish between a zero of multiplicity 1 and one of higher odd multiplicity. Look again closely at the graphs of $a(x) = x(x+2)^2$ and $F(x) = x^3(x+2)^2$ from Exercise 3.1.1. Discuss with your classmates how the graphs are fundamentally different at the origin. It might help to use a graphing calculator to zoom in on the origin to see the different crossing behavior. Also compare the behavior of $a(x) = x(x+2)^2$ to that of $g(x) = x(x+2)^3$ near the point $(-2, 0)$. What do you predict will happen at the zeros of $f(x) = (x-1)(x-2)^2(x-3)^3(x-4)^4(x-5)^5$?
38. Here are a few other questions for you to discuss with your classmates.
- How many local extrema could a polynomial of degree n have? How few local extrema can it have?
 - Could a polynomial have two local maxima but no local minima?
 - If a polynomial has two local maxima and two local minima, can it be of odd degree? Can it be of even degree?
 - Can a polynomial have local extrema without having any real zeros?
 - Why must every polynomial of odd degree have at least one real zero?
 - Can a polynomial have two distinct real zeros and no local extrema?
 - Can an x -intercept yield a local extrema? Can it yield an absolute extrema?
 - If the y -intercept yields an absolute minimum, what can we say about the degree of the polynomial and the sign of the leading coefficient?

3.1.2 ANSWERS

1. $f(x) = 4 - x - 3x^2$
 Degree 2
 Leading term $-3x^2$
 Leading coefficient -3
 Constant term 4
 As $x \rightarrow -\infty$, $f(x) \rightarrow -\infty$
 As $x \rightarrow \infty$, $f(x) \rightarrow -\infty$
2. $g(x) = 3x^5 - 2x^2 + x + 1$
 Degree 5
 Leading term $3x^5$
 Leading coefficient 3
 Constant term 1
 As $x \rightarrow -\infty$, $g(x) \rightarrow -\infty$
 As $x \rightarrow \infty$, $g(x) \rightarrow \infty$
3. $q(r) = 1 - 16r^4$
 Degree 4
 Leading term $-16r^4$
 Leading coefficient -16
 Constant term 1
 As $r \rightarrow -\infty$, $q(r) \rightarrow -\infty$
 As $r \rightarrow \infty$, $q(r) \rightarrow -\infty$
4. $Z(b) = 42b - b^3$
 Degree 3
 Leading term $-b^3$
 Leading coefficient -1
 Constant term 0
 As $b \rightarrow -\infty$, $Z(b) \rightarrow \infty$
 As $b \rightarrow \infty$, $Z(b) \rightarrow -\infty$
5. $f(x) = \sqrt{3}x^{17} + 22.5x^{10} - \pi x^7 + \frac{1}{3}$
 Degree 17
 Leading term $\sqrt{3}x^{17}$
 Leading coefficient $\sqrt{3}$
 Constant term $\frac{1}{3}$
 As $x \rightarrow -\infty$, $f(x) \rightarrow -\infty$
 As $x \rightarrow \infty$, $f(x) \rightarrow \infty$
6. $s(t) = -4.9t^2 + v_0t + s_0$
 Degree 2
 Leading term $-4.9t^2$
 Leading coefficient -4.9
 Constant term s_0
 As $t \rightarrow -\infty$, $s(t) \rightarrow -\infty$
 As $t \rightarrow \infty$, $s(t) \rightarrow -\infty$
7. $P(x) = (x - 1)(x - 2)(x - 3)(x - 4)$
 Degree 4
 Leading term x^4
 Leading coefficient 1
 Constant term 24
 As $x \rightarrow -\infty$, $P(x) \rightarrow -\infty$
 As $x \rightarrow \infty$, $P(x) \rightarrow \infty$
8. $p(t) = -t^2(3 - 5t)(t^2 + t + 4)$
 Degree 5
 Leading term $5t^5$
 Leading coefficient 5
 Constant term 0
 As $t \rightarrow -\infty$, $p(t) \rightarrow -\infty$
 As $t \rightarrow \infty$, $p(t) \rightarrow \infty$

9. $f(x) = -2x^3(x+1)(x+2)^2$

Degree 6

Leading term $-2x^6$ Leading coefficient -2

Constant term 0

As $x \rightarrow -\infty$, $f(x) \rightarrow -\infty$ As $x \rightarrow \infty$, $f(x) \rightarrow -\infty$

10. $G(t) = 4(t-2)^2(t + \frac{1}{2})$

Degree 3

Leading term $4t^3$

Leading coefficient 4

Constant term 8

As $t \rightarrow -\infty$, $G(t) \rightarrow -\infty$ As $t \rightarrow \infty$, $G(t) \rightarrow \infty$

11. $a(x) = x(x+2)^2$

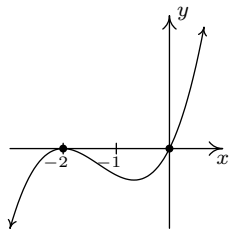
 $x = 0$ multiplicity 1 $x = -2$ multiplicity 2

12. $g(x) = x(x+2)^3$

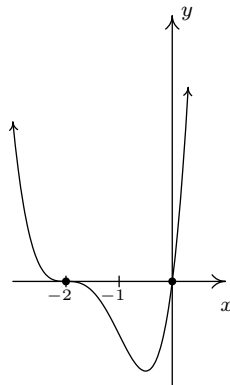
 $x = 0$ multiplicity 1 $x = -2$ multiplicity 3

13. $f(x) = -2(x-2)^2(x+1)$

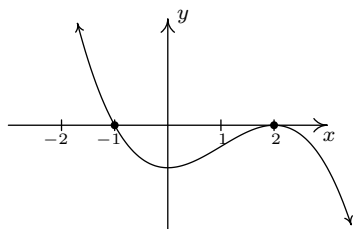
 $x = 2$ multiplicity 2 $x = -1$ multiplicity 1

14. $g(x) = (2x+1)^2(x-3)$

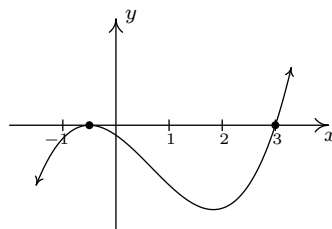
 $x = -\frac{1}{2}$ multiplicity 2 $x = 3$ multiplicity 1

15. $F(x) = x^3(x+2)^2$
 $x = 0$ multiplicity 3
 $x = -2$ multiplicity 2

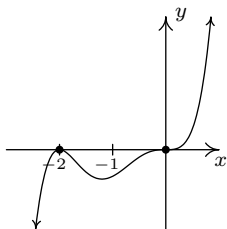

16. $P(x) = (x-1)(x-2)(x-3)(x-4)$
 $x = 1$ multiplicity 1
 $x = 2$ multiplicity 1
 $x = 3$ multiplicity 1
 $x = 4$ multiplicity 1

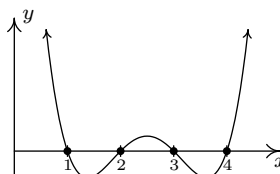

17. $Q(x) = (x+5)^2(x-3)^4$
 $x = -5$ multiplicity 2
 $x = 3$ multiplicity 4

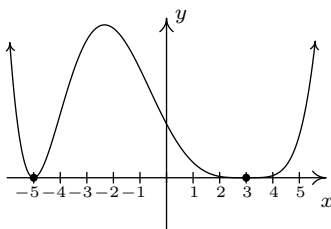

18. $f(x) = x^2(x-2)^2(x+2)^2$
 $x = -2$ multiplicity 2
 $x = 0$ multiplicity 2
 $x = 2$ multiplicity 2

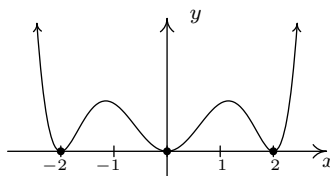

19. $H(t) = (3-t)(t^2+1)$
 $x = 3$ multiplicity 1

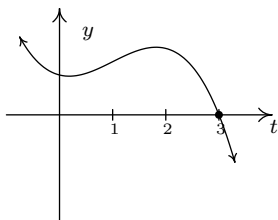

20. $Z(b) = b(42 - b^2)$
 $b = -\sqrt{42}$ multiplicity 1
 $b = 0$ multiplicity 1
 $b = \sqrt{42}$ multiplicity 1

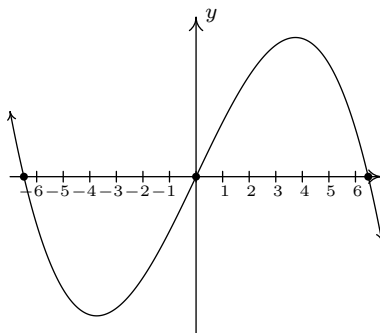

21. $g(x) = (x + 2)^3 + 1$
 domain: $(-\infty, \infty)$
 range: $(-\infty, \infty)$

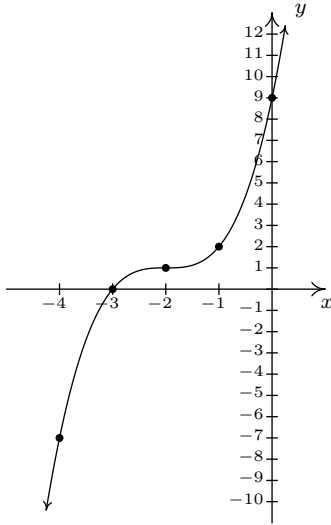

22. $g(x) = (x + 2)^4 + 1$
 domain: $(-\infty, \infty)$
 range: $[1, \infty)$

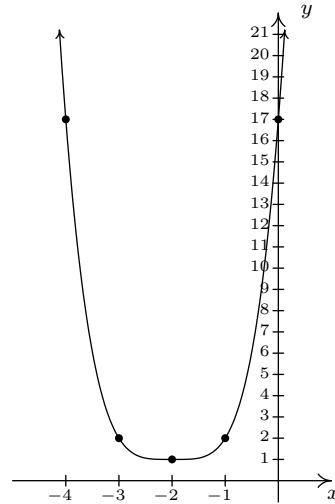

23. $g(x) = 2 - 3(x - 1)^4$
 domain: $(-\infty, \infty)$
 range: $(-\infty, 2]$

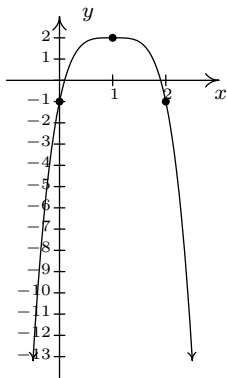

24. $g(x) = -x^5 - 3$
 domain: $(-\infty, \infty)$
 range: $(-\infty, \infty)$

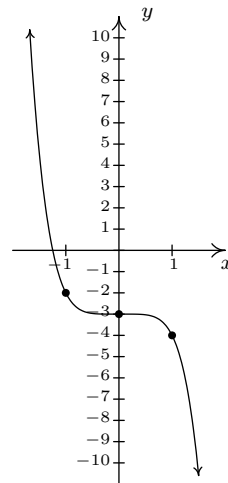

25. $g(x) = (x + 1)^5 + 10$
 domain: $(-\infty, \infty)$
 range: $(-\infty, \infty)$

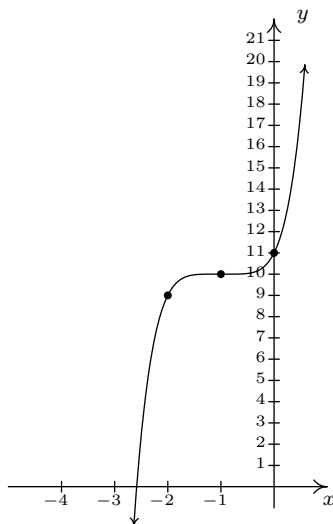

26. $g(x) = 8 - x^6$
 domain: $(-\infty, \infty)$
 range: $(-\infty, 8]$

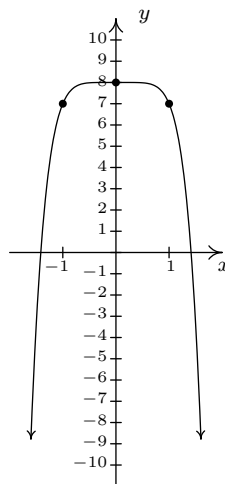

27. We have $f(-4) = -23$, $f(-3) = 5$, $f(0) = 5$, $f(1) = -3$, $f(2) = -5$ and $f(3) = 5$ so the Intermediate Value Theorem tells us that $f(x) = x^3 - 9x + 5$ has real zeros in the intervals $[-4, -3]$, $[0, 1]$ and $[2, 3]$.
28. $V(x) = x(8.5 - 2x)(11 - 2x) = 4x^3 - 39x^2 + 93.5x$, $0 < x < 4.25$. Volume is maximized when $x \approx 1.58$, so the dimensions of the box with maximum volume are: height ≈ 1.58 inches, width ≈ 5.34 inches, and depth ≈ 7.84 inches. The maximum volume is ≈ 66.15 cubic inches.
29. The calculator gives the location of the absolute maximum (rounded to three decimal places) as $x \approx 6.305$ and $y \approx 1115.417$. Since x represents the number of TVs sold in hundreds, $x = 6.305$ corresponds to 630.5 TVs. Since we can't sell half of a TV, we compare $R(6.30) \approx 1115.415$ and $R(6.31) \approx 1115.416$, so selling 631 TVs results in a (slightly) higher revenue. Since y represents the revenue in *thousands* of dollars, the maximum revenue is \$1,115,416.
30. $P(x) = R(x) - C(x) = -5x^3 + 35x^2 - 45x - 25$, $0 \leq x \leq 10.07$.
31. The calculator gives the location of the absolute maximum (rounded to three decimal places) as $x \approx 3.897$ and $y \approx 35.255$. Since x represents the number of TVs sold in hundreds, $x = 3.897$ corresponds to 389.7 TVs. Since we can't sell 0.7 of a TV, we compare $P(3.89) \approx 35.254$ and $P(3.90) \approx 35.255$, so selling 390 TVs results in a (slightly) higher revenue. Since y represents the revenue in *thousands* of dollars, the maximum revenue is \$35,255.
32. Making and selling 71 PortaBoys yields a maximized profit of \$5910.67.

33. (a) Our ultimate goal is to maximize the volume, so we'll start with the maximum Length + Girth of 130. This means the length is $130 - 4x$. The volume of a rectangular box is always length \times width \times height so we get $V(x) = x^2(130 - 4x) = -4x^3 + 130x^2$.
- (b) Graphing $y = V(x)$ on $[0, 33] \times [0, 21000]$ shows a maximum at $(21.67, 20342.59)$ so the dimensions of the box with maximum volume are 21.67in. \times 21.67in. \times 43.32in. for a volume of 20342.59in.³.
- (c) If we start with Length + Girth = 108 then the length is $108 - 4x$ and the volume is $V(x) = -4x^3 + 108x^2$. Graphing $y = V(x)$ on $[0, 27] \times [0, 11700]$ shows a maximum at $(18.00, 11664.00)$ so the dimensions of the box with maximum volume are 18.00in. \times 18.00in. \times 36in. for a volume of 11664.00in.³. (Calculus will confirm that the measurements which maximize the volume are exactly 18in. by 18in. by 36in., however, as I'm sure you are aware by now, we treat all calculator results as approximations and list them as such.)
34. The cubic regression model is $p_3(x) = 0.0226x^3 - 0.9508x^2 + 8.615x - 3.446$. It has $R^2 = 0.93765$ which isn't bad. The graph of $y = p_3(x)$ in the viewing window $[-1, 13] \times [0, 24]$ along with the scatter plot is shown below on the left. Notice that p_3 hits the x -axis at about $x = 12.45$ making this a bad model for future predictions. To use the model to approximate the number of hours of sunlight on your birthday, you'll have to figure out what decimal value of x is close enough to your birthday and then plug it into the model. My (Jeff's) birthday is July 31 which is 10 days after July 21 ($x = 7$). Assuming 30 days in a month, I think $x = 7.33$ should work for my birthday and $p_3(7.33) \approx 17.5$. The website says there will be about 18.25 hours of daylight that day. To have 14 hours of darkness we need 10 hours of daylight. We see that $p_3(1.96) \approx 10$ and $p_3(10.05) \approx 10$ so it seems reasonable to say that we'll have at least 14 hours of darkness from December 21, 2008 ($x = 0$) to February 21, 2009 ($x = 2$) and then again from October 21, 2009 ($x = 10$) to December 21, 2009 ($x = 12$).

The quartic regression model is $p_4(x) = 0.0144x^4 - 0.3507x^3 + 2.259x^2 - 1.571x + 5.513$. It has $R^2 = 0.98594$ which is good. The graph of $y = p_4(x)$ in the viewing window $[-1, 15] \times [0, 35]$ along with the scatter plot is shown below on the right. Notice that $p_4(15)$ is above 24 making this a bad model as well for future predictions. However, $p_4(7.33) \approx 18.71$ making it much better at predicting the hours of daylight on July 31 (my birthday). This model says we'll have at least 14 hours of darkness from December 21, 2008 ($x = 0$) to about March 1, 2009 ($x = 2.30$) and then again from October 10, 2009 ($x = 9.667$) to December 21, 2009 ($x = 12$).

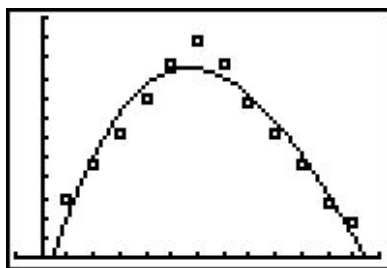
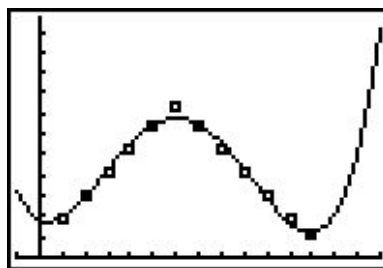

 $y = p_3(x)$

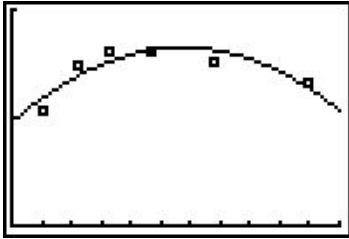
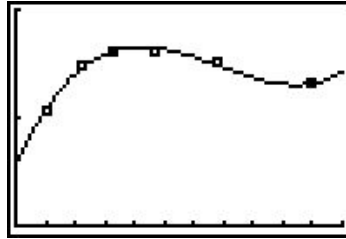
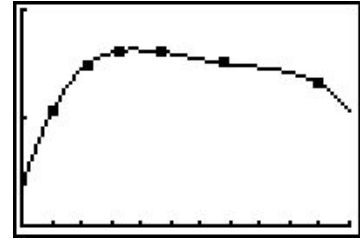
 $y = p_4(x)$

35. (a) The scatter plot is shown below with each of the three regression models.
- (b) The quadratic model is $P_2(x) = -0.02x^2 + 0.241x + 0.956$ with $R^2 = 0.77708$.
 The cubic model is $P_3(x) = 0.005x^3 - 0.103x^2 + 0.602x + 0.573$ with $R^2 = 0.98153$.
 The quartic model is $P_4(x) = -0.000969x^4 + 0.0253x^3 - 0.240x^2 + 0.944x + 0.330$ with $R^2 = 0.99929$.
- (c) The maximums predicted by the three models are $P_2(5.737) \approx 1.648$, $P_3(4.232) \approx 1.657$ and $P_4(3.784) \approx 1.630$, respectively.

 $y = P_2(x)$

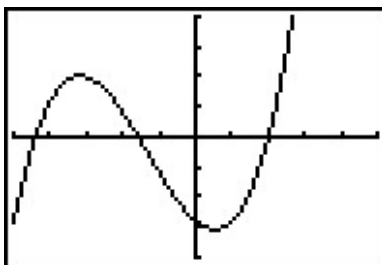
 $y = P_3(x)$

 $y = P_4(x)$

3.2 THE FACTOR THEOREM AND THE REMAINDER THEOREM

Suppose we wish to find the zeros of $f(x) = x^3 + 4x^2 - 5x - 14$. Setting $f(x) = 0$ results in the polynomial equation $x^3 + 4x^2 - 5x - 14 = 0$. Despite all of the factoring techniques we learned¹ in Intermediate Algebra, this equation foils² us at every turn. If we graph f using the graphing calculator, we get



The graph suggests that the function has three zeros, one of which is $x = 2$. It's easy to show that $f(2) = 0$, but the other two zeros seem to be less friendly. Even though we could use the 'Zero' command to find decimal approximations for these, we seek a method to find the remaining zeros *exactly*. Based on our experience, if $x = 2$ is a zero, it seems that there should be a factor of $(x - 2)$ lurking around in the factorization of $f(x)$. In other words, we should expect that $x^3 + 4x^2 - 5x - 14 = (x - 2)q(x)$, where $q(x)$ is some other polynomial. How could we find such a $q(x)$, if it even exists? The answer comes from our old friend, polynomial division. Dividing $x^3 + 4x^2 - 5x - 14$ by $x - 2$ gives

$$\begin{array}{r}
 x^2 + 6x + 7 \\
 x-2 \overline{) x^3 + 4x^2 - 5x - 14} \\
 \underline{-(x^3 - 2x^2)} \\
 6x^2 - 5x \\
 \underline{-(6x^2 - 12x)} \\
 7x - 14 \\
 \underline{-(7x - 14)} \\
 0
 \end{array}$$

As you may recall, this means $x^3 + 4x^2 - 5x - 14 = (x - 2)(x^2 + 6x + 7)$, so to find the zeros of f , we now solve $(x - 2)(x^2 + 6x + 7) = 0$. We get $x - 2 = 0$ (which gives us our known zero, $x = 2$) as well as $x^2 + 6x + 7 = 0$. The latter doesn't factor nicely, so we apply the Quadratic Formula to get $x = -3 \pm \sqrt{2}$. The point of this section is to generalize the technique applied here. First up is a friendly reminder of what we can expect when we divide polynomials.

¹and probably forgot

²pun intended

Theorem 3.4. Polynomial Division: Suppose $d(x)$ and $p(x)$ are nonzero polynomials where the degree of p is greater than or equal to the degree of d . There exist two unique polynomials, $q(x)$ and $r(x)$, such that $p(x) = d(x)q(x) + r(x)$, where either $r(x) = 0$ or the degree of r is strictly less than the degree of d .

As you may recall, all of the polynomials in Theorem 3.4 have special names. The polynomial p is called the **dividend**; d is the **divisor**; q is the **quotient**; r is the **remainder**. If $r(x) = 0$ then d is called a **factor** of p . The proof of Theorem 3.4 is usually relegated to a course in Abstract Algebra,³ but we can still use the result to establish two important facts which are the basis of the rest of the chapter.

Theorem 3.5. The Remainder Theorem: Suppose p is a polynomial of degree at least 1 and c is a real number. When $p(x)$ is divided by $x - c$ the remainder is $p(c)$.

The proof of Theorem 3.5 is a direct consequence of Theorem 3.4. When a polynomial is divided by $x - c$, the remainder is either 0 or has degree less than the degree of $x - c$. Since $x - c$ is degree 1, the degree of the remainder must be 0, which means the remainder is a constant. Hence, in either case, $p(x) = (x - c)q(x) + r$, where r , the remainder, is a real number, possibly 0. It follows that $p(c) = (c - c)q(c) + r = 0 \cdot q(c) + r = r$, so we get $r = p(c)$ as required. There is one last ‘low hanging fruit’⁴ to collect which we present below.

Theorem 3.6. The Factor Theorem: Suppose p is a nonzero polynomial. The real number c is a zero of p if and only if $(x - c)$ is a factor of $p(x)$.

The proof of The Factor Theorem is a consequence of what we already know. If $(x - c)$ is a factor of $p(x)$, this means $p(x) = (x - c)q(x)$ for some polynomial q . Hence, $p(c) = (c - c)q(c) = 0$, so c is a zero of p . Conversely, if c is a zero of p , then $p(c) = 0$. In this case, The Remainder Theorem tells us the remainder when $p(x)$ is divided by $(x - c)$, namely $p(c)$, is 0, which means $(x - c)$ is a factor of p . What we have established is the fundamental connection between zeros of polynomials and factors of polynomials.

Of the things The Factor Theorem tells us, the most pragmatic is that we had better find a more efficient way to divide polynomials by quantities of the form $x - c$. Fortunately, people like [Ruffini](#) and [Horner](#) have already blazed this trail. Let’s take a closer look at the long division we performed at the beginning of the section and try to streamline it. First off, let’s change all of the subtractions into additions by distributing through the -1 s.

³Yes, Virginia, there are Algebra courses more abstract than this one.

⁴Jeff hates this expression and Carl included it just to annoy him.

$$\begin{array}{r}
 x^2 + 6x + 7 \\
 x-2 \overline{) x^3 + 4x^2 - 5x - 14} \\
 \underline{-x^3 + 2x^2} \\
 6x^2 - 5x \\
 \underline{-6x^2 + 12x} \\
 7x - 14 \\
 \underline{-7x + 14} \\
 0
 \end{array}$$

Next, observe that the terms $-x^3$, $-6x^2$ and $-7x$ are the exact opposite of the terms above them. The algorithm we use ensures this is always the case, so we can omit them without losing any information. Also note that the terms we ‘bring down’ (namely the $-5x$ and -14) aren’t really necessary to recopy, so we omit them, too.

$$\begin{array}{r}
 x^2 + 6x + 7 \\
 x-2 \overline{) x^3 + 4x^2 - 5x - 14} \\
 \underline{2x^2} \\
 6x^2 \\
 \underline{12x} \\
 7x \\
 \underline{14} \\
 0
 \end{array}$$

Now, let’s move things up a bit and, for reasons which will become clear in a moment, copy the x^3 into the last row.

$$\begin{array}{r}
 x^2 + 6x + 7 \\
 x-2 \overline{) x^3 + 4x^2 - 5x - 14} \\
 \underline{2x^2 \quad 12x \quad 14} \\
 x^3 \quad 6x^2 \quad 7x \quad 0
 \end{array}$$

Note that by arranging things in this manner, each term in the last row is obtained by adding the two terms above it. Notice also that the quotient polynomial can be obtained by dividing each of the first three terms in the last row by x and adding the results. If you take the time to work back through the original division problem, you will find that this is exactly the way we determined the quotient polynomial. This means that we no longer need to write the quotient polynomial down, nor the x in the divisor, to determine our answer.

$$\begin{array}{r}
 -2 \mid x^3 + 4x^2 - 5x - 14 \\
 \underline{2x^2 \quad 12x \quad 14} \\
 x^3 \quad 6x^2 \quad 7x \quad 0
 \end{array}$$

We've streamlined things quite a bit so far, but we can still do more. Let's take a moment to remind ourselves where the $2x^2$, $12x$ and 14 came from in the second row. Each of these terms was obtained by multiplying the terms in the quotient, x^2 , $6x$ and 7 , respectively, by the -2 in $x - 2$, then by -1 when we changed the subtraction to addition. Multiplying by -2 then by -1 is the same as multiplying by 2 , so we replace the -2 in the divisor by 2 . Furthermore, the coefficients of the quotient polynomial match the coefficients of the first three terms in the last row, so we now take the plunge and write only the coefficients of the terms to get

$$\begin{array}{r|rrrr} 2 & 1 & 4 & -5 & -14 \\ & & 2 & 12 & 14 \\ \hline & 1 & 6 & 7 & 0 \end{array}$$

We have constructed a **synthetic division tableau** for this polynomial division problem. Let's rework our division problem using this tableau to see how it greatly streamlines the division process. To divide $x^3 + 4x^2 - 5x - 14$ by $x - 2$, we write 2 in the place of the divisor and the coefficients of $x^3 + 4x^2 - 5x - 14$ in for the dividend. Then 'bring down' the first coefficient of the dividend.

$$\begin{array}{r|rrrr} 2 & 1 & 4 & -5 & -14 \\ \hline & & & & \end{array} \qquad \begin{array}{r|rrrr} 2 & 1 & 4 & -5 & -14 \\ & & & \downarrow & \\ & & & 1 & \\ \hline & & & & \end{array}$$

Next, take the 2 from the divisor and multiply by the 1 that was 'brought down' to get 2 . Write this underneath the 4 , then add to get 6 .

$$\begin{array}{r|rrrr} 2 & 1 & 4 & -5 & -14 \\ & & \downarrow 2 & & \\ \hline & & 1 & & \end{array} \qquad \begin{array}{r|rrrr} 2 & 1 & 4 & -5 & -14 \\ & & \downarrow 2 & & \\ \hline & & 1 & 6 & \end{array}$$

Now take the 2 from the divisor times the 6 to get 12 , and add it to the -5 to get 7 .

$$\begin{array}{r|rrrr} 2 & 1 & 4 & -5 & -14 \\ & & \downarrow 2 & 12 & \\ \hline & & 1 & 6 & \end{array} \qquad \begin{array}{r|rrrr} 2 & 1 & 4 & -5 & -14 \\ & & \downarrow 2 & 12 & \\ \hline & & 1 & 6 & 7 \end{array}$$

Finally, take the 2 in the divisor times the 7 to get 14 , and add it to the -14 to get 0 .

$$\begin{array}{r|rrrr} 2 & 1 & 4 & -5 & -14 \\ & & \downarrow 2 & 12 & 14 \\ \hline & & 1 & 6 & 7 \end{array} \qquad \begin{array}{r|rrrr} 2 & 1 & 4 & -5 & -14 \\ & & \downarrow 2 & 12 & 14 \\ \hline & & 1 & 6 & 7 & \boxed{0} \end{array}$$

The first three numbers in the last row of our tableau are the coefficients of the quotient polynomial. Remember, we started with a third degree polynomial and divided by a first degree polynomial, so the quotient is a second degree polynomial. Hence the quotient is $x^2 + 6x + 7$. The number in the box is the remainder. Synthetic division is our tool of choice for dividing polynomials by divisors of the form $x - c$. It is important to note that it works *only* for these kinds of divisors.⁵ Also take note that when a polynomial (of degree at least 1) is divided by $x - c$, the result will be a polynomial of exactly one less degree. Finally, it is worth the time to trace each step in synthetic division back to its corresponding step in long division. While the authors have done their best to indicate where the algorithm comes from, there is no substitute for working through it yourself.

Example 3.2.1. Use synthetic division to perform the following polynomial divisions. Find the quotient and the remainder polynomials, then write the dividend, quotient and remainder in the form given in Theorem 3.4.

$$1. (5x^3 - 2x^2 + 1) \div (x - 3) \quad 2. (x^3 + 8) \div (x + 2) \quad 3. \frac{4 - 8x - 12x^2}{2x - 3}$$

Solution.

- When setting up the synthetic division tableau, we need to enter 0 for the coefficient of x in the dividend. Doing so gives

$$\begin{array}{r|rrrr} 3 & 5 & -2 & 0 & 1 \\ & \downarrow & 15 & 39 & 117 \\ \hline & 5 & 13 & 39 & \boxed{118} \end{array}$$

Since the dividend was a third degree polynomial, the quotient is a quadratic polynomial with coefficients 5, 13 and 39. Our quotient is $q(x) = 5x^2 + 13x + 39$ and the remainder is $r(x) = 118$. According to Theorem 3.4, we have $5x^3 - 2x^2 + 1 = (x - 3)(5x^2 + 13x + 39) + 118$.

- For this division, we rewrite $x + 2$ as $x - (-2)$ and proceed as before

$$\begin{array}{r|rrrr} -2 & 1 & 0 & 0 & 8 \\ & \downarrow & -2 & 4 & -8 \\ \hline & 1 & -2 & 4 & \boxed{0} \end{array}$$

We get the quotient $q(x) = x^2 - 2x + 4$ and the remainder $r(x) = 0$. Relating the dividend, quotient and remainder gives $x^3 + 8 = (x + 2)(x^2 - 2x + 4)$.

- To divide $4 - 8x - 12x^2$ by $2x - 3$, two things must be done. First, we write the dividend in descending powers of x as $-12x^2 - 8x + 4$. Second, since synthetic division works only for factors of the form $x - c$, we factor $2x - 3$ as $2(x - \frac{3}{2})$. Our strategy is to first divide $-12x^2 - 8x + 4$ by 2, to get $-6x^2 - 4x + 2$. Next, we divide by $(x - \frac{3}{2})$. The tableau becomes

⁵You'll need to use good old-fashioned polynomial long division for divisors of degree larger than 1.

$$\begin{array}{r|rrr} \frac{3}{2} & -6 & -4 & 2 \\ & \downarrow & -9 & -\frac{39}{2} \\ \hline & -6 & -13 & \boxed{-\frac{35}{2}} \end{array}$$

From this, we get $-6x^2 - 4x + 2 = (x - \frac{3}{2})(-6x - 13) - \frac{35}{2}$. Multiplying both sides by 2 and distributing gives $-12x^2 - 8x + 4 = (2x - 3)(-6x - 13) - 35$. At this stage, we have written $-12x^2 - 8x + 4$ in the **form** $(2x - 3)q(x) + r(x)$, but how can we be sure the quotient polynomial is $-6x - 13$ and the remainder is -35 ? The answer is the word ‘unique’ in Theorem 3.4. The theorem states that there is only one way to decompose $-12x^2 - 8x + 4$ into a multiple of $(2x - 3)$ plus a constant term. Since we have found such a way, we can be sure it is the only way. \square

The next example pulls together all of the concepts discussed in this section.

Example 3.2.2. Let $p(x) = 2x^3 - 5x + 3$.

1. Find $p(-2)$ using The Remainder Theorem. Check your answer by substitution.
2. Use the fact that $x = 1$ is a zero of p to factor $p(x)$ and then find all of the real zeros of p .

Solution.

1. The Remainder Theorem states $p(-2)$ is the remainder when $p(x)$ is divided by $x - (-2)$. We set up our synthetic division tableau below. We are careful to record the coefficient of x^2 as 0, and proceed as above.

$$\begin{array}{r|rrrr} -2 & 2 & 0 & -5 & 3 \\ & \downarrow & -4 & 8 & -6 \\ \hline & 2 & -4 & 3 & \boxed{-3} \end{array}$$

According to the Remainder Theorem, $p(-2) = -3$. We can check this by direct substitution into the formula for $p(x)$: $p(-2) = 2(-2)^3 - 5(-2) + 3 = -16 + 10 + 3 = -3$.

2. The Factor Theorem tells us that since $x = 1$ is a zero of p , $x - 1$ is a factor of $p(x)$. To factor $p(x)$, we divide

$$\begin{array}{r|rrrr} 1 & 2 & 0 & -5 & 3 \\ & \downarrow & 2 & 2 & -3 \\ \hline & 2 & 2 & -3 & \boxed{0} \end{array}$$

We get a remainder of 0 which verifies that, indeed, $p(1) = 0$. Our quotient polynomial is a second degree polynomial with coefficients 2, 2, and -3 . So $q(x) = 2x^2 + 2x - 3$. Theorem 3.4 tells us $p(x) = (x - 1)(2x^2 + 2x - 3)$. To find the remaining real zeros of p , we need to solve $2x^2 + 2x - 3 = 0$ for x . Since this doesn't factor nicely, we use the quadratic formula to find that the remaining zeros are $x = \frac{-1 \pm \sqrt{7}}{2}$. \square

In Section 3.1, we discussed the notion of the multiplicity of a zero. Roughly speaking, a zero with multiplicity 2 can be divided twice into a polynomial; multiplicity 3, three times and so on. This is illustrated in the next example.

Example 3.2.3. Let $p(x) = 4x^4 - 4x^3 - 11x^2 + 12x - 3$. Given that $x = \frac{1}{2}$ is a zero of multiplicity 2, find all of the real zeros of p .

Solution. We set up for synthetic division. Since we are told the multiplicity of $\frac{1}{2}$ is two, we continue our tableau and divide $\frac{1}{2}$ into the quotient polynomial

$$\begin{array}{r|rrrrr} \frac{1}{2} & 4 & -4 & -11 & 12 & -3 \\ & \downarrow & 2 & -1 & -6 & 3 \\ \hline \frac{1}{2} & 4 & -2 & -12 & 6 & \boxed{0} \\ & \downarrow & 2 & 0 & -6 & \\ \hline & 4 & 0 & -12 & \boxed{0} & \end{array}$$

From the first division, we get $4x^4 - 4x^3 - 11x^2 + 12x - 3 = (x - \frac{1}{2})(4x^3 - 2x^2 - 12x + 6)$. The second division tells us $4x^3 - 2x^2 - 12x + 6 = (x - \frac{1}{2})(4x^2 - 12)$. Combining these results, we have $4x^4 - 4x^3 - 11x^2 + 12x - 3 = (x - \frac{1}{2})^2(4x^2 - 12)$. To find the remaining zeros of p , we set $4x^2 - 12 = 0$ and get $x = \pm\sqrt{3}$. \square

A couple of things about the last example are worth mentioning. First, the extension of the synthetic division tableau for repeated divisions will be a common site in the sections to come. Typically, we will start with a higher order polynomial and peel off one zero at a time until we are left with a quadratic, whose roots can always be found using the Quadratic Formula. Secondly, we found $x = \pm\sqrt{3}$ are zeros of p . The Factor Theorem guarantees $(x - \sqrt{3})$ and $(x - (-\sqrt{3}))$ are both factors of p . We can certainly put the Factor Theorem to the test and continue the synthetic division tableau from above to see what happens.

$$\begin{array}{r|rrrrr} \frac{1}{2} & 4 & -4 & -11 & 12 & -3 \\ & \downarrow & 2 & -1 & -6 & 3 \\ \hline \frac{1}{2} & 4 & -2 & -12 & 6 & \boxed{0} \\ & \downarrow & 2 & 0 & -6 & \\ \hline \sqrt{3} & 4 & 0 & -12 & \boxed{0} & \\ & \downarrow & 4\sqrt{3} & 12 & & \\ \hline -\sqrt{3} & 4 & 4\sqrt{3} & \boxed{0} & & \\ & \downarrow & -4\sqrt{3} & & & \\ \hline & 4 & \boxed{0} & & & \end{array}$$

This gives us $4x^4 - 4x^3 - 11x^2 + 12x - 3 = (x - \frac{1}{2})^2(x - \sqrt{3})(x - (-\sqrt{3}))(4)$, or, when written with the constant in front

$$p(x) = 4 \left(x - \frac{1}{2}\right)^2 (x - \sqrt{3}) (x - (-\sqrt{3}))$$

We have shown that p is a product of its leading coefficient times linear factors of the form $(x - c)$ where c are zeros of p . It may surprise and delight the reader that, in theory, all polynomials can be reduced to this kind of factorization. We leave that discussion to Section 3.4, because the zeros may not be real numbers. Our final theorem in the section gives us an upper bound on the number of real zeros.

Theorem 3.7. Suppose f is a polynomial of degree $n \geq 1$. Then f has at most n real zeros, counting multiplicities.

Theorem 3.7 is a consequence of the Factor Theorem and polynomial multiplication. Every zero c of f gives us a factor of the form $(x - c)$ for $f(x)$. Since f has degree n , there can be at most n of these factors. The next section provides us some tools which not only help us determine where the real zeros are to be found, but which real numbers they may be.

We close this section with a summary of several concepts previously presented. You should take the time to look back through the text to see where each concept was first introduced and where each connection to the other concepts was made.

Connections Between Zeros, Factors and Graphs of Polynomial Functions

Suppose p is a polynomial function of degree $n \geq 1$. The following statements are equivalent:

- The real number c is a zero of p
- $p(c) = 0$
- $x = c$ is a solution to the polynomial equation $p(x) = 0$
- $(x - c)$ is a factor of $p(x)$
- The point $(c, 0)$ is an x -intercept of the graph of $y = p(x)$

3.2.1 EXERCISES

In Exercises 1 - 6, use polynomial long division to perform the indicated division. Write the polynomial in the form $p(x) = d(x)q(x) + r(x)$.

1. $(4x^2 + 3x - 1) \div (x - 3)$

2. $(2x^3 - x + 1) \div (x^2 + x + 1)$

3. $(5x^4 - 3x^3 + 2x^2 - 1) \div (x^2 + 4)$

4. $(-x^5 + 7x^3 - x) \div (x^3 - x^2 + 1)$

5. $(9x^3 + 5) \div (2x - 3)$

6. $(4x^2 - x - 23) \div (x^2 - 1)$

In Exercises 7 - 20 use synthetic division to perform the indicated division. Write the polynomial in the form $p(x) = d(x)q(x) + r(x)$.

7. $(3x^2 - 2x + 1) \div (x - 1)$

8. $(x^2 - 5) \div (x - 5)$

9. $(3 - 4x - 2x^2) \div (x + 1)$

10. $(4x^2 - 5x + 3) \div (x + 3)$

11. $(x^3 + 8) \div (x + 2)$

12. $(4x^3 + 2x - 3) \div (x - 3)$

13. $(18x^2 - 15x - 25) \div (x - \frac{5}{3})$

14. $(4x^2 - 1) \div (x - \frac{1}{2})$

15. $(2x^3 + x^2 + 2x + 1) \div (x + \frac{1}{2})$

16. $(3x^3 - x + 4) \div (x - \frac{2}{3})$

17. $(2x^3 - 3x + 1) \div (x - \frac{1}{2})$

18. $(4x^4 - 12x^3 + 13x^2 - 12x + 9) \div (x - \frac{3}{2})$

19. $(x^4 - 6x^2 + 9) \div (x - \sqrt{3})$

20. $(x^6 - 6x^4 + 12x^2 - 8) \div (x + \sqrt{2})$

In Exercises 21 - 30, determine $p(c)$ using the Remainder Theorem for the given polynomial functions and value of c . If $p(c) = 0$, factor $p(x) = (x - c)q(x)$.

21. $p(x) = 2x^2 - x + 1, c = 4$

22. $p(x) = 4x^2 - 33x - 180, c = 12$

23. $p(x) = 2x^3 - x + 6, c = -3$

24. $p(x) = x^3 + 2x^2 + 3x + 4, c = -1$

25. $p(x) = 3x^3 - 6x^2 + 4x - 8, c = 2$

26. $p(x) = 8x^3 + 12x^2 + 6x + 1, c = -\frac{1}{2}$

27. $p(x) = x^4 - 2x^2 + 4, c = \frac{3}{2}$

28. $p(x) = 6x^4 - x^2 + 2, c = -\frac{2}{3}$

29. $p(x) = x^4 + x^3 - 6x^2 - 7x - 7, c = -\sqrt{7}$

30. $p(x) = x^2 - 4x + 1, c = 2 - \sqrt{3}$

In Exercises 31 - 40, you are given a polynomial and one of its zeros. Use the techniques in this section to find the rest of the real zeros and factor the polynomial.

31. $x^3 - 6x^2 + 11x - 6$, $c = 1$

32. $x^3 - 24x^2 + 192x - 512$, $c = 8$

33. $3x^3 + 4x^2 - x - 2$, $c = \frac{2}{3}$

34. $2x^3 - 3x^2 - 11x + 6$, $c = \frac{1}{2}$

35. $x^3 + 2x^2 - 3x - 6$, $c = -2$

36. $2x^3 - x^2 - 10x + 5$, $c = \frac{1}{2}$

37. $4x^4 - 28x^3 + 61x^2 - 42x + 9$, $c = \frac{1}{2}$ is a zero of multiplicity 2

38. $x^5 + 2x^4 - 12x^3 - 38x^2 - 37x - 12$, $c = -1$ is a zero of multiplicity 3

39. $125x^5 - 275x^4 - 2265x^3 - 3213x^2 - 1728x - 324$, $c = -\frac{3}{5}$ is a zero of multiplicity 3

40. $x^2 - 2x - 2$, $c = 1 - \sqrt{3}$

In Exercises 41 - 45, create a polynomial p which has the desired characteristics. You may leave the polynomial in factored form.

41. • The zeros of p are $c = \pm 2$ and $c = \pm 1$

• The leading term of $p(x)$ is $117x^4$.

42. • The zeros of p are $c = 1$ and $c = 3$

• $c = 3$ is a zero of multiplicity 2.

• The leading term of $p(x)$ is $-5x^3$

43. • The solutions to $p(x) = 0$ are $x = \pm 3$ and $x = 6$

• The leading term of $p(x)$ is $7x^4$

• The point $(-3, 0)$ is a local minimum on the graph of $y = p(x)$.

44. • The solutions to $p(x) = 0$ are $x = \pm 3$, $x = -2$, and $x = 4$.

• The leading term of $p(x)$ is $-x^5$.

• The point $(-2, 0)$ is a local maximum on the graph of $y = p(x)$.

45. • p is degree 4.

• as $x \rightarrow \infty$, $p(x) \rightarrow -\infty$

• p has exactly three x -intercepts: $(-6, 0)$, $(1, 0)$ and $(117, 0)$

• The graph of $y = p(x)$ crosses through the x -axis at $(1, 0)$.

46. Find a quadratic polynomial with integer coefficients which has $x = \frac{3}{5} \pm \frac{\sqrt{29}}{5}$ as its real zeros.

3.2.2 ANSWERS

1. $4x^2 + 3x - 1 = (x - 3)(4x + 15) + 44$
2. $2x^3 - x + 1 = (x^2 + x + 1)(2x - 2) + (-x + 3)$
3. $5x^4 - 3x^3 + 2x^2 - 1 = (x^2 + 4)(5x^2 - 3x - 18) + (12x + 71)$
4. $-x^5 + 7x^3 - x = (x^3 - x^2 + 1)(-x^2 - x + 6) + (7x^2 - 6)$
5. $9x^3 + 5 = (2x - 3)\left(\frac{9}{2}x^2 + \frac{27}{4}x + \frac{81}{8}\right) + \frac{283}{8}$
6. $4x^2 - x - 23 = (x^2 - 1)(4) + (-x - 19)$
7. $(3x^2 - 2x + 1) = (x - 1)(3x + 1) + 2$
8. $(x^2 - 5) = (x - 5)(x + 5) + 20$
9. $(3 - 4x - 2x^2) = (x + 1)(-2x - 2) + 5$
10. $(4x^2 - 5x + 3) = (x + 3)(4x - 17) + 54$
11. $(x^3 + 8) = (x + 2)(x^2 - 2x + 4) + 0$
12. $(4x^3 + 2x - 3) = (x - 3)(4x^2 + 12x + 38) + 111$
13. $(18x^2 - 15x - 25) = \left(x - \frac{5}{3}\right)(18x + 15) + 0$
14. $(4x^2 - 1) = \left(x - \frac{1}{2}\right)(4x + 2) + 0$
15. $(2x^3 + x^2 + 2x + 1) = \left(x + \frac{1}{2}\right)(2x^2 + 2) + 0$
16. $(3x^3 - x + 4) = \left(x - \frac{2}{3}\right)\left(3x^2 + 2x + \frac{1}{3}\right) + \frac{38}{9}$
17. $(2x^3 - 3x + 1) = \left(x - \frac{1}{2}\right)\left(2x^2 + x - \frac{5}{2}\right) - \frac{1}{4}$
18. $(4x^4 - 12x^3 + 13x^2 - 12x + 9) = \left(x - \frac{3}{2}\right)(4x^3 - 6x^2 + 4x - 6) + 0$
19. $(x^4 - 6x^2 + 9) = (x - \sqrt{3})(x^3 + \sqrt{3}x^2 - 3x - 3\sqrt{3}) + 0$
20. $(x^6 - 6x^4 + 12x^2 - 8) = (x + \sqrt{2})(x^5 - \sqrt{2}x^4 - 4x^3 + 4\sqrt{2}x^2 + 4x - 4\sqrt{2}) + 0$
21. $p(4) = 29$
22. $p(12) = 0, p(x) = (x - 12)(4x + 15)$
23. $p(-3) = -45$
24. $p(-1) = 2$
25. $p(2) = 0, p(x) = (x - 2)(3x^2 + 4)$
26. $p\left(-\frac{1}{2}\right) = 0, p(x) = \left(x + \frac{1}{2}\right)(8x^2 + 8x + 2)$

27. $p\left(\frac{3}{2}\right) = \frac{73}{16}$

28. $p\left(-\frac{2}{3}\right) = \frac{74}{27}$

29. $p(-\sqrt{7}) = 0$, $p(x) = (x + \sqrt{7})(x^3 + (1 - \sqrt{7})x^2 + (1 - \sqrt{7})x - \sqrt{7})$

30. $p(2 - \sqrt{3}) = 0$, $p(x) = (x - (2 - \sqrt{3}))(x - (2 + \sqrt{3}))$

31. $x^3 - 6x^2 + 11x - 6 = (x - 1)(x - 2)(x - 3)$

32. $x^3 - 24x^2 + 192x - 512 = (x - 8)^3$

33. $3x^3 + 4x^2 - x - 2 = 3\left(x - \frac{2}{3}\right)(x + 1)^2$

34. $2x^3 - 3x^2 - 11x + 6 = 2\left(x - \frac{1}{2}\right)(x + 2)(x - 3)$

35. $x^3 + 2x^2 - 3x - 6 = (x + 2)(x + \sqrt{3})(x - \sqrt{3})$

36. $2x^3 - x^2 - 10x + 5 = 2\left(x - \frac{1}{2}\right)(x + \sqrt{5})(x - \sqrt{5})$

37. $4x^4 - 28x^3 + 61x^2 - 42x + 9 = 4\left(x - \frac{1}{2}\right)^2(x - 3)^2$

38. $x^5 + 2x^4 - 12x^3 - 38x^2 - 37x - 12 = (x + 1)^3(x + 3)(x - 4)$

39. $125x^5 - 275x^4 - 2265x^3 - 3213x^2 - 1728x - 324 = 125\left(x + \frac{3}{5}\right)^3(x + 2)(x - 6)$

40. $x^2 - 2x - 2 = (x - (1 - \sqrt{3}))(x - (1 + \sqrt{3}))$

41. $p(x) = 117(x + 2)(x - 2)(x + 1)(x - 1)$

42. $p(x) = -5(x - 1)(x - 3)^2$

43. $p(x) = 7(x + 3)^2(x - 3)(x - 6)$

44. $p(x) = -(x + 2)^2(x - 3)(x + 3)(x - 4)$

45. $p(x) = a(x + 6)^2(x - 1)(x - 117)$ or $p(x) = a(x + 6)(x - 1)(x - 117)^2$ where a can be any negative real number

46. $p(x) = 5x^2 - 6x - 4$

3.3 REAL ZEROS OF POLYNOMIALS

In Section 3.2, we found that we can use synthetic division to determine if a given real number is a zero of a polynomial function. This section presents results which will help us determine good candidates to test using synthetic division. There are two approaches to the topic of finding the real zeros of a polynomial. The first approach (which is gaining popularity) is to use a little bit of Mathematics followed by a good use of technology like graphing calculators. The second approach (for purists) makes good use of mathematical machinery (theorems) only. For completeness, we include the two approaches but in separate subsections.¹ Both approaches benefit from the following two theorems, the first of which is due to the famous mathematician [Augustin Cauchy](#). It gives us an interval on which all of the real zeros of a polynomial can be found.

Theorem 3.8. Cauchy's Bound: Suppose $f(x) = a_nx^n + a_{n-1}x^{n-1} + \dots + a_1x + a_0$ is a polynomial of degree n with $n \geq 1$. Let M be the largest of the numbers: $\frac{|a_0|}{|a_n|}, \frac{|a_1|}{|a_n|}, \dots, \frac{|a_{n-1}|}{|a_n|}$. Then all the real zeros of f lie in the interval $[-(M + 1), M + 1]$.

The proof of this fact is not easily explained within the confines of this text. This [paper](#) contains the result and gives references to its proof. Like many of the results in this section, Cauchy's Bound is best understood with an example.

Example 3.3.1. Let $f(x) = 2x^4 + 4x^3 - x^2 - 6x - 3$. Determine an interval which contains all of the real zeros of f .

Solution. To find the M stated in Cauchy's Bound, we take the absolute value of the leading coefficient, in this case $|2| = 2$ and divide it into the largest (in absolute value) of the remaining coefficients, in this case $|-6| = 6$. This yields $M = 3$ so it is guaranteed that all of the real zeros of f lie in the interval $[-4, 4]$. \square

Whereas the previous result tells us *where* we can find the real zeros of a polynomial, the next theorem gives us a list of *possible* real zeros.

Theorem 3.9. Rational Zeros Theorem: Suppose $f(x) = a_nx^n + a_{n-1}x^{n-1} + \dots + a_1x + a_0$ is a polynomial of degree n with $n \geq 1$, and a_0, a_1, \dots, a_n are integers. If r is a rational zero of f , then r is of the form $\pm \frac{p}{q}$, where p is a factor of the constant term a_0 , and q is a factor of the leading coefficient a_n .

The Rational Zeros Theorem gives us a list of numbers to try in our synthetic division and that is a lot nicer than simply guessing. If none of the numbers in the list are zeros, then either the polynomial has no real zeros at all, or all of the real zeros are irrational numbers. To see why the Rational Zeros Theorem works, suppose c is a zero of f and $c = \frac{p}{q}$ in lowest terms. This means p and q have no common factors. Since $f(c) = 0$, we have

$$a_n \left(\frac{p}{q}\right)^n + a_{n-1} \left(\frac{p}{q}\right)^{n-1} + \dots + a_1 \left(\frac{p}{q}\right) + a_0 = 0.$$

¹Carl is the purist and is responsible for all of the theorems in this section. Jeff, on the other hand, has spent too much time in school politics and has been polluted with notions of 'compromise.' You can blame the slow decline of civilization on him and those like him who mingle Mathematics with technology.

Multiplying both sides of this equation by q^n , we clear the denominators to get

$$a_n p^n + a_{n-1} p^{n-1} q + \dots + a_1 p q^{n-1} + a_0 q^n = 0$$

Rearranging this equation, we get

$$a_n p^n = -a_{n-1} p^{n-1} q - \dots - a_1 p q^{n-1} - a_0 q^n$$

Now, the left hand side is an integer multiple of p , and the right hand side is an integer multiple of q . (Can you see why?) This means $a_n p^n$ is both a multiple of p and a multiple of q . Since p and q have no common factors, a_n must be a multiple of q . If we rearrange the equation

$$a_n p^n + a_{n-1} p^{n-1} q + \dots + a_1 p q^{n-1} + a_0 q^n = 0$$

as

$$a_0 q^n = -a_n p^n - a_{n-1} p^{n-1} q - \dots - a_1 p q^{n-1}$$

we can play the same game and conclude a_0 is a multiple of p , and we have the result.

Example 3.3.2. Let $f(x) = 2x^4 + 4x^3 - x^2 - 6x - 3$. Use the Rational Zeros Theorem to list all of the possible rational zeros of f .

Solution. To generate a complete list of rational zeros, we need to take each of the factors of constant term, $a_0 = -3$, and divide them by each of the factors of the leading coefficient $a_4 = 2$. The factors of -3 are ± 1 and ± 3 . Since the Rational Zeros Theorem tacks on a \pm anyway, for the moment, we consider only the positive factors 1 and 3. The factors of 2 are 1 and 2, so the Rational Zeros Theorem gives the list $\{\pm \frac{1}{1}, \pm \frac{1}{2}, \pm \frac{3}{1}, \pm \frac{3}{2}\}$ or $\{\pm \frac{1}{2}, \pm 1, \pm \frac{3}{2}, \pm 3\}$. \square

Our discussion now diverges between those who wish to use technology and those who do not.

3.3.1 FOR THOSE WISHING TO USE A GRAPHING CALCULATOR

At this stage, we know not only the interval in which all of the zeros of $f(x) = 2x^4 + 4x^3 - x^2 - 6x - 3$ are located, but we also know some potential candidates. We can now use our calculator to help us determine all of the real zeros of f , as illustrated in the next example.

Example 3.3.3. Let $f(x) = 2x^4 + 4x^3 - x^2 - 6x - 3$.

1. Graph $y = f(x)$ on the calculator using the interval obtained in Example 3.3.1 as a guide.
2. Use the graph to shorten the list of possible rational zeros obtained in Example 3.3.2.
3. Use synthetic division to find the real zeros of f , and state their multiplicities.

Solution.

1. In Example 3.3.1, we determined all of the real zeros of f lie in the interval $[-4, 4]$. We set our window accordingly and get

```

WINDOW
Xmin=-4
Xmax=4
Xscl=1
Ymin=-4
Ymax=4
Yscl=1
Xres=1

```

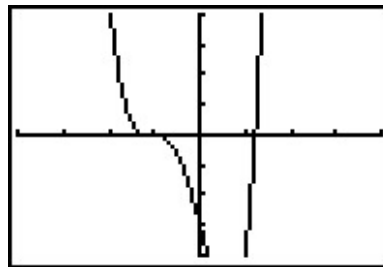

2. In Example 3.3.2, we learned that any rational zero of f must be in the list $\{\pm \frac{1}{2}, \pm 1, \pm \frac{3}{2}, \pm 3\}$. From the graph, it looks as if we can rule out any of the positive rational zeros, since the graph seems to cross the x -axis at a value just a little greater than 1. On the negative side, -1 looks good, so we try that for our synthetic division.

$$\begin{array}{r|rrrrr}
 -1 & 2 & 4 & -1 & -6 & -3 \\
 & \downarrow & -2 & -2 & 3 & 3 \\
 \hline
 & 2 & 2 & -3 & -3 & \boxed{0}
 \end{array}$$

We have a winner! Remembering that f was a fourth degree polynomial, we know that our quotient is a third degree polynomial. If we can do one more successful division, we will have knocked the quotient down to a quadratic, and, if all else fails, we can use the quadratic formula to find the last two zeros. Since there seems to be no other rational zeros to try, we continue with -1 . Also, the shape of the crossing at $x = -1$ leads us to wonder if the zero $x = -1$ has multiplicity 3.

$$\begin{array}{r|rrrrr}
 -1 & 2 & 4 & -1 & -6 & -3 \\
 & \downarrow & -2 & -2 & 3 & 3 \\
 -1 & \hline
 & 2 & 2 & -3 & -3 & \boxed{0} \\
 & \downarrow & -2 & 0 & 3 & \\
 & \hline
 & 2 & 0 & -3 & \boxed{0}
 \end{array}$$

Success! Our quotient polynomial is now $2x^2 - 3$. Setting this to zero gives $2x^2 - 3 = 0$, or $x^2 = \frac{3}{2}$, which gives us $x = \pm \frac{\sqrt{6}}{2}$. Concerning multiplicities, based on our division, we have that -1 has a multiplicity of at least 2. The Factor Theorem tells us our remaining zeros, $\pm \frac{\sqrt{6}}{2}$, each have multiplicity at least 1. However, Theorem 3.7 tells us f can have at most 4 real zeros, counting multiplicity, and so we conclude that -1 is of multiplicity exactly 2 and $\pm \frac{\sqrt{6}}{2}$ each has multiplicity 1. (Thus, we were wrong to think that -1 had multiplicity 3.) \square

It is interesting to note that we could greatly improve on the graph of $y = f(x)$ in the previous example given to us by the calculator. For instance, from our determination of the zeros of f and their multiplicities, we know the graph crosses at $x = -\frac{\sqrt{6}}{2} \approx -1.22$ then turns back upwards to touch the x -axis at $x = -1$. This tells us that, despite what the calculator showed us the first time, there is a relative maximum occurring at $x = -1$ and not a ‘flattened crossing’ as we originally

believed. After resizing the window, we see not only the relative maximum but also a relative minimum² just to the left of $x = -1$ which shows us, once again, that Mathematics enhances the technology, instead of vice-versa.

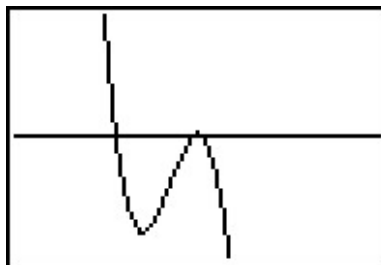
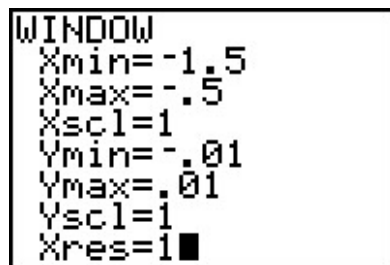

Our next example shows how even a mild-mannered polynomial can cause problems.

Example 3.3.4. Let $f(x) = x^4 + x^2 - 12$.

1. Use Cauchy's Bound to determine an interval in which all of the real zeros of f lie.
2. Use the Rational Zeros Theorem to determine a list of possible rational zeros of f .
3. Graph $y = f(x)$ using your graphing calculator.
4. Find all of the real zeros of f and their multiplicities.

Solution.

1. Applying Cauchy's Bound, we find $M = 12$, so all of the real zeros lie in the interval $[-13, 13]$.
2. Applying the Rational Zeros Theorem with constant term $a_0 = -12$ and leading coefficient $a_4 = 1$, we get the list $\{\pm 1, \pm 2, \pm 3, \pm 4, \pm 6, \pm 12\}$.
3. Graphing $y = f(x)$ on the interval $[-13, 13]$ produces the graph below on the left. Zooming in a bit gives the graph below on the right. Based on the graph, none of our rational zeros will work. (Do you see why not?)

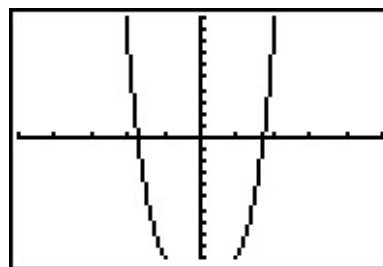
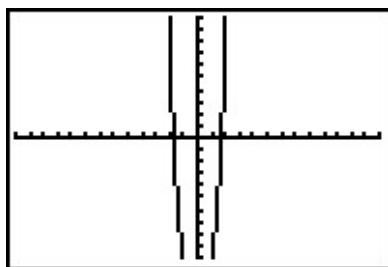

²This is an example of what is called 'hidden behavior.'

4. From the graph, we know f has two real zeros, one positive, and one negative. Our only hope at this point is to try and find the zeros of f by setting $f(x) = x^4 + x^2 - 12 = 0$ and solving. If we stare at this equation long enough, we may recognize it as a ‘quadratic in disguise’ or ‘quadratic in form’. In other words, we have three terms: x^4 , x^2 and 12, and the exponent on the first term, x^4 , is exactly twice that of the second term, x^2 . We may rewrite this as $(x^2)^2 + (x^2) - 12 = 0$. To better see the forest for the trees, we momentarily replace x^2 with the variable u . In terms of u , our equation becomes $u^2 + u - 12 = 0$, which we can readily factor as $(u + 4)(u - 3) = 0$. In terms of x , this means $x^4 + x^2 - 12 = (x^2 - 3)(x^2 + 4) = 0$. We get $x^2 = 3$, which gives us $x = \pm\sqrt{3}$, or $x^2 = -4$, which admits no real solutions. Since $\sqrt{3} \approx 1.73$, the two zeros match what we expected from the graph. In terms of multiplicity, the Factor Theorem guarantees $(x - \sqrt{3})$ and $(x + \sqrt{3})$ are factors of $f(x)$. Since $f(x)$ can be factored as $f(x) = (x^2 - 3)(x^2 + 4)$, and $x^2 + 4$ has no real zeros, the quantities $(x - \sqrt{3})$ and $(x + \sqrt{3})$ must both be factors of $x^2 - 3$. According to Theorem 3.7, $x^2 - 3$ can have at most 2 zeros, counting multiplicity, hence each of $\pm\sqrt{3}$ is a zero of f of multiplicity 1. \square

The technique used to factor $f(x)$ in Example 3.3.4 is called **u -substitution**. We shall see more of this technique in Section 5.3. In general, substitution can help us identify a ‘quadratic in disguise’ provided that there are exactly three terms and the exponent of the first term is exactly twice that of the second. It is entirely possible that a polynomial has no real roots at all, or worse, it has real roots but none of the techniques discussed in this section can help us find them exactly. In the latter case, we are forced to approximate, which in this subsection means we use the ‘Zero’ command on the graphing calculator.

3.3.2 FOR THOSE WISHING NOT TO USE A GRAPHING CALCULATOR

Suppose we wish to find the zeros of $f(x) = 2x^4 + 4x^3 - x^2 - 6x - 3$ *without* using the calculator. In this subsection, we present some more advanced mathematical tools (theorems) to help us. Our first result is due to [René Descartes](#).

Theorem 3.10. Descartes’ Rule of Signs: Suppose $f(x)$ is the formula for a polynomial function written with descending powers of x .

- If P denotes the number of variations of sign in the formula for $f(x)$, then the number of positive real zeros (counting multiplicity) is one of the numbers $\{P, P - 2, P - 4, \dots\}$.
- If N denotes the number of variations of sign in the formula for $f(-x)$, then the number of negative real zeros (counting multiplicity) is one of the numbers $\{N, N - 2, N - 4, \dots\}$.

A few remarks are in order. First, to use Descartes’ Rule of Signs, we need to understand what is meant by a ‘**variation in sign**’ of a polynomial function. Consider $f(x) = 2x^4 + 4x^3 - x^2 - 6x - 3$. If we focus on only the *signs* of the coefficients, we start with a (+), followed by another (+), then switch to (−), and stay (−) for the remaining two coefficients. Since the signs of the coefficients switched *once* as we read from left to right, we say that $f(x)$ has *one* variation in sign. When

we speak of the variations in sign of a polynomial function f we assume the formula for $f(x)$ is written with descending powers of x , as in Definition 3.1, and concern ourselves only with the nonzero coefficients. Second, unlike the Rational Zeros Theorem, Descartes' Rule of Signs gives us an estimate to the *number* of positive and negative real zeros, not the actual *value* of the zeros. Lastly, Descartes' Rule of Signs counts multiplicities. This means that, for example, if one of the zeros has multiplicity 2, Descartes' Rule of Signs would count this as *two* zeros. Lastly, note that the number of positive or negative real zeros always starts with the number of sign changes and decreases by an even number. For example, if $f(x)$ has 7 sign changes, then, counting multiplicities, f has either 7, 5, 3 or 1 positive real zero. This implies that the graph of $y = f(x)$ crosses the positive x -axis at least once. If $f(-x)$ results in 4 sign changes, then, counting multiplicities, f has 4, 2 or 0 negative real zeros; hence, the graph of $y = f(x)$ may not cross the negative x -axis at all. The proof of Descartes' Rule of Signs is a bit technical, and can be found [here](#).

Example 3.3.5. Let $f(x) = 2x^4 + 4x^3 - x^2 - 6x - 3$. Use Descartes' Rule of Signs to determine the possible number and location of the real zeros of f .

Solution. As noted above, the variations in sign of $f(x)$ is 1. This means, counting multiplicities, f has exactly 1 positive real zero. Since $f(-x) = 2(-x)^4 + 4(-x)^3 - (-x)^2 - 6(-x) - 3 = 2x^4 - 4x^3 - x^2 + 6x - 3$ has 3 variations in sign, f has either 3 negative real zeros or 1 negative real zero, counting multiplicities. \square

Cauchy's Bound gives us a general bound on the zeros of a polynomial function. Our next result helps us determine bounds on the real zeros of a polynomial as we synthetically divide which are often sharper³ bounds than Cauchy's Bound.

Theorem 3.11. Upper and Lower Bounds: Suppose f is a polynomial of degree $n \geq 1$.

- If $c > 0$ is synthetically divided into f and all of the numbers in the final line of the division tableau have the same signs, then c is an upper bound for the real zeros of f . That is, there are no real zeros greater than c .
- If $c < 0$ is synthetically divided into f and the numbers in the final line of the division tableau alternate signs, then c is a lower bound for the real zeros of f . That is, there are no real zeros less than c .

NOTE: If the number 0 occurs in the final line of the division tableau in either of the above cases, it can be treated as (+) or (-) as needed.

The Upper and Lower Bounds Theorem works because of Theorem 3.4. For the upper bound part of the theorem, suppose $c > 0$ is divided into f and the resulting line in the division tableau contains, for example, all nonnegative numbers. This means $f(x) = (x - c)q(x) + r$, where the coefficients of the quotient polynomial and the remainder are nonnegative. (Note that the leading coefficient of q is the same as f so $q(x)$ is not the zero polynomial.) If $b > c$, then $f(b) = (b - c)q(b) + r$, where $(b - c)$ and $q(b)$ are both positive and $r \geq 0$. Hence $f(b) > 0$ which shows b cannot be a zero of f . Thus no real number $b > c$ can be a zero of f , as required. A similar argument proves

³That is, better, or more accurate.

$f(b) < 0$ if all of the numbers in the final line of the synthetic division tableau are non-positive. To prove the lower bound part of the theorem, we note that a lower bound for the negative real zeros of $f(x)$ is an upper bound for the positive real zeros of $f(-x)$. Applying the upper bound portion to $f(-x)$ gives the result. (Do you see where the alternating signs come in?) With the additional mathematical machinery of Descartes' Rule of Signs and the Upper and Lower Bounds Theorem, we can find the real zeros of $f(x) = 2x^4 + 4x^3 - x^2 - 6x - 3$ without the use of a graphing calculator.

Example 3.3.6. Let $f(x) = 2x^4 + 4x^3 - x^2 - 6x - 3$.

1. Find all of the real zeros of f and their multiplicities.
2. Sketch the graph of $y = f(x)$.

Solution.

1. We know from Cauchy's Bound that all of the real zeros lie in the interval $[-4, 4]$ and that our possible rational zeros are $\pm \frac{1}{2}$, ± 1 , $\pm \frac{3}{2}$ and ± 3 . Descartes' Rule of Signs guarantees us at least one negative real zero and exactly one positive real zero, counting multiplicity. We try our positive rational zeros, starting with the smallest, $\frac{1}{2}$. Since the remainder isn't zero, we know $\frac{1}{2}$ isn't a zero. Sadly, the final line in the division tableau has both positive and negative numbers, so $\frac{1}{2}$ is not an upper bound. The only information we get from this division is courtesy of the Remainder Theorem which tells us $f(\frac{1}{2}) = -\frac{45}{8}$ so the point $(\frac{1}{2}, -\frac{45}{8})$ is on the graph of f . We continue to our next possible zero, 1. As before, the only information we can glean from this is that $(1, -4)$ is on the graph of f . When we try our next possible zero, $\frac{3}{2}$, we get that it is not a zero, and we also see that it is an upper bound on the zeros of f , since all of the numbers in the final line of the division tableau are positive. This means there is no point trying our last possible rational zero, 3. Descartes' Rule of Signs guaranteed us a positive real zero, and at this point we have shown this zero is irrational. Furthermore, the Intermediate Value Theorem, Theorem 3.1, tells us the zero lies between 1 and $\frac{3}{2}$, since $f(1) < 0$ and $f(\frac{3}{2}) > 0$.

$$\begin{array}{r|rrrrr} \frac{1}{2} & 2 & 4 & -1 & -6 & -3 \\ & \downarrow & 1 & \frac{5}{2} & \frac{3}{4} & -\frac{21}{8} \\ \hline & 2 & 5 & \frac{3}{2} & -\frac{21}{4} & \boxed{-\frac{45}{8}} \end{array} \quad
 \begin{array}{r|rrrrr} 1 & 2 & 4 & -1 & -6 & -3 \\ & \downarrow & 2 & 6 & 5 & -1 \\ \hline & 2 & 6 & 5 & -1 & \boxed{-4} \end{array} \quad
 \begin{array}{r|rrrrr} \frac{3}{2} & 2 & 4 & -1 & -6 & -3 \\ & \downarrow & 3 & \frac{21}{2} & \frac{57}{4} & \frac{99}{8} \\ \hline & 2 & 7 & \frac{19}{2} & \frac{33}{4} & \boxed{\frac{75}{8}} \end{array}$$

We now turn our attention to negative real zeros. We try the largest possible zero, $-\frac{1}{2}$. Synthetic division shows us it is not a zero, nor is it a lower bound (since the numbers in the final line of the division tableau do not alternate), so we proceed to -1 . This division shows -1 is a zero. Descartes' Rule of Signs told us that we may have up to three negative real zeros, counting multiplicity, so we try -1 again, and it works once more. At this point, we have taken f , a fourth degree polynomial, and performed two successful divisions. Our quotient polynomial is quadratic, so we look at it to find the remaining zeros.

$$\begin{array}{r|rrrrr}
 -\frac{1}{2} & 2 & 4 & -1 & -6 & -3 \\
 & \downarrow & -1 & -\frac{3}{2} & \frac{5}{4} & \frac{19}{8} \\
 \hline
 & 2 & 3 & -\frac{5}{2} & -\frac{19}{4} & \boxed{-\frac{5}{8}}
 \end{array}$$

$$\begin{array}{r|rrrrr}
 -1 & 2 & 4 & -1 & -6 & -3 \\
 & \downarrow & -2 & -2 & 3 & 3 \\
 -1 & \hline
 & 2 & 2 & -3 & -3 & \boxed{0} \\
 & \downarrow & -2 & 0 & 3 & \\
 & \hline
 & 2 & 0 & -3 & \boxed{0}
 \end{array}$$

Setting the quotient polynomial equal to zero yields $2x^2 - 3 = 0$, so that $x^2 = \frac{3}{2}$, or $x = \pm \frac{\sqrt{6}}{2}$. Descartes' Rule of Signs tells us that the positive real zero we found, $\frac{\sqrt{6}}{2}$, has multiplicity 1. Descartes also tells us the total multiplicity of negative real zeros is 3, which forces -1 to be a zero of multiplicity 2 and $-\frac{\sqrt{6}}{2}$ to have multiplicity 1.

2. We know the end behavior of $y = f(x)$ resembles that of its leading term $y = 2x^4$. This means that the graph enters the scene in Quadrant II and exits in Quadrant I. Since $\pm \frac{\sqrt{6}}{2}$ are zeros of odd multiplicity, we have that the graph crosses through the x -axis at the points $(-\frac{\sqrt{6}}{2}, 0)$ and $(\frac{\sqrt{6}}{2}, 0)$. Since -1 is a zero of multiplicity 2, the graph of $y = f(x)$ touches and rebounds off the x -axis at $(-1, 0)$. Putting this together, we get

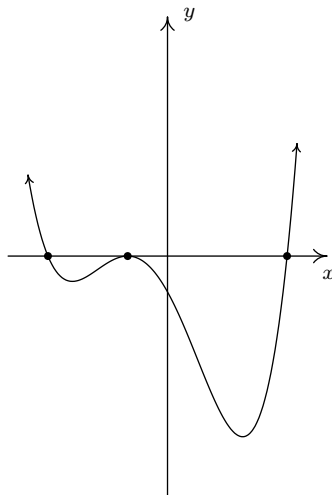

□

You can see why the ‘no calculator’ approach is not very popular these days. It requires more computation and more theorems than the alternative.⁴ In general, no matter how many theorems you throw at a polynomial, it may well be impossible⁵ to find their zeros exactly. The polynomial $f(x) = x^5 - x - 1$ is one such beast.⁶ According to Descartes' Rule of Signs, f has exactly one positive real zero, and it could have two negative real zeros, or none at all. The Rational Zeros

⁴This is apparently a bad thing.

⁵We don't use this word lightly; it can be proven that the zeros of some polynomials cannot be expressed using the usual algebraic symbols.

⁶See this [page](#).

Test gives us ± 1 as rational zeros to try but neither of these work since $f(1) = f(-1) = -1$. If we try the substitution technique we used in Example 3.3.4, we find $f(x)$ has three terms, but the exponent on the x^5 isn't exactly twice the exponent on x . How could we go about approximating the positive zero without resorting to the 'Zero' command of a graphing calculator? We use the **Bisection Method**. The first step in the Bisection Method is to find an interval on which f changes sign. We know $f(1) = -1$ and we find $f(2) = 29$. By the Intermediate Value Theorem, we know that the zero of f lies in the interval $[1, 2]$. Next, we 'bisect' this interval and find the midpoint is 1.5. We have that $f(1.5) \approx 5.09$. This means that our zero is between 1 and 1.5, since f changes sign on this interval. Now, we 'bisect' the interval $[1, 1.5]$ and find $f(1.25) \approx 0.80$, so now we have the zero between 1 and 1.25. Bisecting $[1, 1.25]$, we find $f(1.125) \approx -0.32$, which means the zero of f is between 1.125 and 1.25. We continue in this fashion until we have 'sandwiched' the zero between two numbers which differ by no more than a desired accuracy. You can think of the Bisection Method as reversing the sign diagram process: instead of finding the zeros and checking the sign of f using test values, we are using test values to determine where the signs switch to find the zeros. It is a slow and tedious, yet fool-proof, method for approximating a real zero.

Our next example reminds us of the role finding zeros plays in solving equations and inequalities.

Example 3.3.7.

1. Find all of the real solutions to the equation $2x^5 + 6x^3 + 3 = 3x^4 + 8x^2$.
2. Solve the inequality $2x^5 + 6x^3 + 3 \leq 3x^4 + 8x^2$.
3. Interpret your answer to part 2 graphically, and verify using a graphing calculator.

Solution.

1. Finding the real solutions to $2x^5 + 6x^3 + 3 = 3x^4 + 8x^2$ is the same as finding the real solutions to $2x^5 - 3x^4 + 6x^3 - 8x^2 + 3 = 0$. In other words, we are looking for the real zeros of $p(x) = 2x^5 - 3x^4 + 6x^3 - 8x^2 + 3$. Using the techniques developed in this section, we get

$$\begin{array}{r|rrrrrr}
 1 & 2 & -3 & 6 & -8 & 0 & 3 \\
 & \downarrow & 2 & -1 & 5 & -3 & -3 \\
 1 & 2 & -1 & 5 & -3 & -3 & \boxed{0} \\
 & \downarrow & 2 & 1 & 6 & 3 & \\
 -\frac{1}{2} & 2 & 1 & 6 & 3 & \boxed{0} & \\
 & \downarrow & -1 & 0 & -3 & & \\
 & 2 & 0 & 6 & \boxed{0} & &
 \end{array}$$

The quotient polynomial is $2x^2 + 6$ which has no real zeros so we get $x = -\frac{1}{2}$ and $x = 1$.

2. To solve this nonlinear inequality, we follow the same guidelines set forth in Section 2.4: we get 0 on one side of the inequality and construct a sign diagram. Our original inequality can be rewritten as $2x^5 - 3x^4 + 6x^3 - 8x^2 + 3 \leq 0$. We found the zeros of $p(x) = 2x^5 - 3x^4 + 6x^3 - 8x^2 + 3$ in part 1 to be $x = -\frac{1}{2}$ and $x = 1$. We construct our sign diagram as before.

$$\begin{array}{ccccccc}
 & (-) & 0 & (+) & 0 & (+) & \\
 & \leftarrow & & & & & \rightarrow \\
 & \uparrow & -\frac{1}{2} & \uparrow & \uparrow & & \\
 & -1 & & 0 & 1 & & 2
 \end{array}$$

The solution to $p(x) < 0$ is $(-\infty, -\frac{1}{2})$, and we know $p(x) = 0$ at $x = -\frac{1}{2}$ and $x = 1$. Hence, the solution to $p(x) \leq 0$ is $(-\infty, -\frac{1}{2}] \cup \{1\}$.

3. To interpret this solution graphically, we set $f(x) = 2x^5 + 6x^3 + 3$ and $g(x) = 3x^4 + 8x^2$. We recall that the solution to $f(x) \leq g(x)$ is the set of x values for which the graph of f is below the graph of g (where $f(x) < g(x)$) along with the x values where the two graphs intersect ($f(x) = g(x)$). Graphing f and g on the calculator produces the picture on the lower left. (The end behavior should tell you which is which.) We see that the graph of f is below the graph of g on $(-\infty, -\frac{1}{2})$. However, it is difficult to see what is happening near $x = 1$. Zooming in (and making the graph of g thicker), we see that the graphs of f and g do intersect at $x = 1$, but the graph of g remains below the graph of f on either side of $x = 1$.

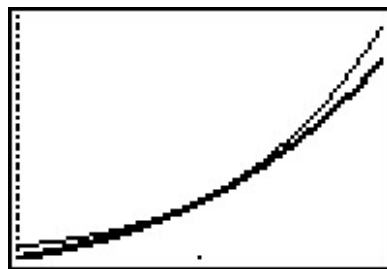
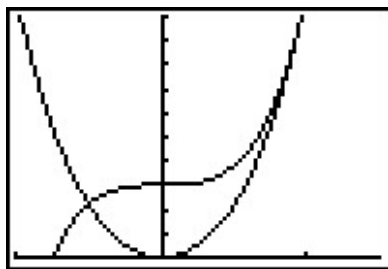

□

Our last example revisits an application from page 381 in the Exercises of Section 3.1.

Example 3.3.8. Suppose the profit P , in *thousands* of dollars, from producing and selling x hundred LCD TVs is given by $P(x) = -5x^3 + 35x^2 - 45x - 25$, $0 \leq x \leq 10.07$. How many TVs should be produced to make a profit? Check your answer using a graphing utility.

Solution. To ‘make a profit’ means to solve $P(x) = -5x^3 + 35x^2 - 45x - 25 > 0$, which we do analytically using a sign diagram. To simplify things, we first factor out the -5 common to all the coefficients to get $-5(x^3 - 7x^2 + 9x - 5) > 0$, so we can just focus on finding the zeros of $f(x) = x^3 - 7x^2 + 9x + 5$. The possible rational zeros of f are ± 1 and ± 5 , and going through the usual computations, we find $x = 5$ is the only rational zero. Using this, we factor $f(x) = x^3 - 7x^2 + 9x + 5 = (x - 5)(x^2 - 2x - 1)$, and we find the remaining zeros by applying the Quadratic Formula to $x^2 - 2x - 1 = 0$. We find three real zeros, $x = 1 - \sqrt{2} = -0.414\dots$, $x = 1 + \sqrt{2} = 2.414\dots$, and $x = 5$, of which only the last two fall in the applied domain of $[0, 10.07]$. We choose $x = 0$, $x = 3$ and $x = 10.07$ as our test values and plug them into the function $P(x) = -5x^3 + 35x^2 - 45x - 25$ (not $f(x) = x^3 - 7x^2 + 9x - 5$) to get the sign diagram below.

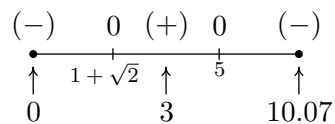

We see immediately that $P(x) > 0$ on $(1 + \sqrt{2}, 5)$. Since x measures the number of TVs in *hundreds*, $x = 1 + \sqrt{2}$ corresponds to 241.4... TVs. Since we can't produce a fractional part of a TV, we need to choose between producing 241 and 242 TVs. From the sign diagram, we see that $P(241) < 0$ but $P(242) > 0$ so, in this case we take the next *larger* integer value and set the minimum production to 242 TVs. At the other end of the interval, we have $x = 5$ which corresponds to 500 TVs. Here, we take the next *smaller* integer value, 499 TVs to ensure that we make a profit. Hence, in order to make a profit, at least 242, but no more than 499 TVs need to be produced. To check our answer using a calculator, we graph $y = P(x)$ and make use of the 'Zero' command. We see that the calculator approximations bear out our analysis.⁷

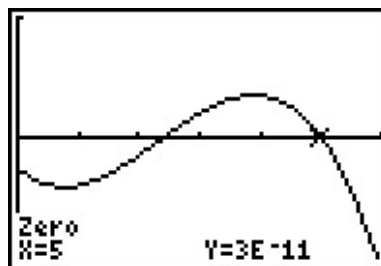
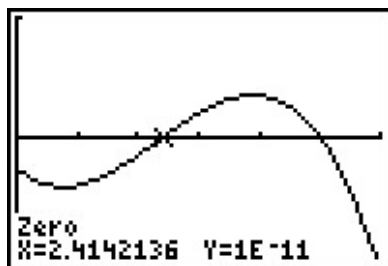

□

⁷Note that the y -coordinates of the points here aren't registered as 0. They are expressed in Scientific Notation. For instance, $1E - 11$ corresponds to 0.00000000001, which is pretty close in the calculator's eyes⁸ to 0.

⁸but not a Mathematician's

3.3.3 EXERCISES

In Exercises 1 - 10, for the given polynomial:

- Use Cauchy's Bound to find an interval containing all of the real zeros.
- Use the Rational Zeros Theorem to make a list of possible rational zeros.
- Use Descartes' Rule of Signs to list the possible number of positive and negative real zeros, counting multiplicities.

1. $f(x) = x^3 - 2x^2 - 5x + 6$

2. $f(x) = x^4 + 2x^3 - 12x^2 - 40x - 32$

3. $f(x) = x^4 - 9x^2 - 4x + 12$

4. $f(x) = x^3 + 4x^2 - 11x + 6$

5. $f(x) = x^3 - 7x^2 + x - 7$

6. $f(x) = -2x^3 + 19x^2 - 49x + 20$

7. $f(x) = -17x^3 + 5x^2 + 34x - 10$

8. $f(x) = 36x^4 - 12x^3 - 11x^2 + 2x + 1$

9. $f(x) = 3x^3 + 3x^2 - 11x - 10$

10. $f(x) = 2x^4 + x^3 - 7x^2 - 3x + 3$

In Exercises 11 - 30, find the real zeros of the polynomial using the techniques specified by your instructor. State the multiplicity of each real zero.

11. $f(x) = x^3 - 2x^2 - 5x + 6$

12. $f(x) = x^4 + 2x^3 - 12x^2 - 40x - 32$

13. $f(x) = x^4 - 9x^2 - 4x + 12$

14. $f(x) = x^3 + 4x^2 - 11x + 6$

15. $f(x) = x^3 - 7x^2 + x - 7$

16. $f(x) = -2x^3 + 19x^2 - 49x + 20$

17. $f(x) = -17x^3 + 5x^2 + 34x - 10$

18. $f(x) = 36x^4 - 12x^3 - 11x^2 + 2x + 1$

19. $f(x) = 3x^3 + 3x^2 - 11x - 10$

20. $f(x) = 2x^4 + x^3 - 7x^2 - 3x + 3$

21. $f(x) = 9x^3 - 5x^2 - x$

22. $f(x) = 6x^4 - 5x^3 - 9x^2$

23. $f(x) = x^4 + 2x^2 - 15$

24. $f(x) = x^4 - 9x^2 + 14$

25. $f(x) = 3x^4 - 14x^2 - 5$

26. $f(x) = 2x^4 - 7x^2 + 6$

27. $f(x) = x^6 - 3x^3 - 10$

28. $f(x) = 2x^6 - 9x^3 + 10$

29. $f(x) = x^5 - 2x^4 - 4x + 8$

30. $f(x) = 2x^5 + 3x^4 - 18x - 27$

In Exercises 31 - 33, use your calculator,⁹ to help you find the real zeros of the polynomial. State the multiplicity of each real zero.

31. $f(x) = x^5 - 60x^3 - 80x^2 + 960x + 2304$

32. $f(x) = 25x^5 - 105x^4 + 174x^3 - 142x^2 + 57x - 9$

33. $f(x) = 90x^4 - 399x^3 + 622x^2 - 399x + 90$

34. Find the real zeros of $f(x) = x^3 - \frac{1}{12}x^2 - \frac{7}{72}x + \frac{1}{72}$ by first finding a polynomial $q(x)$ with integer coefficients such that $q(x) = N \cdot f(x)$ for some integer N . (Recall that the Rational Zeros Theorem required the polynomial in question to have integer coefficients.) Show that f and q have the same real zeros.

In Exercises 35 - 44, find the real solutions of the polynomial equation. (See Example 3.3.7.)

35. $9x^3 = 5x^2 + x$

36. $9x^2 + 5x^3 = 6x^4$

37. $x^3 + 6 = 2x^2 + 5x$

38. $x^4 + 2x^3 = 12x^2 + 40x + 32$

39. $x^3 - 7x^2 = 7 - x$

40. $2x^3 = 19x^2 - 49x + 20$

41. $x^3 + x^2 = \frac{11x + 10}{3}$

42. $x^4 + 2x^2 = 15$

43. $14x^2 + 5 = 3x^4$

44. $2x^5 + 3x^4 = 18x + 27$

In Exercises 45 - 54, solve the polynomial inequality and state your answer using interval notation.

45. $-2x^3 + 19x^2 - 49x + 20 > 0$

46. $x^4 - 9x^2 \leq 4x - 12$

47. $(x - 1)^2 \geq 4$

48. $4x^3 \geq 3x + 1$

49. $x^4 \leq 16 + 4x - x^3$

50. $3x^2 + 2x < x^4$

51. $\frac{x^3 + 2x^2}{2} < x + 2$

52. $\frac{x^3 + 20x}{8} \geq x^2 + 2$

53. $2x^4 > 5x^2 + 3$

54. $x^6 + x^3 \geq 6$

55. In Example 3.1.3 in Section 3.1, a box with no top is constructed from a 10 inch \times 12 inch piece of cardboard by cutting out congruent squares from each corner of the cardboard and then folding the resulting tabs. We determined the volume of that box (in cubic inches) is given by $V(x) = 4x^3 - 44x^2 + 120x$, where x denotes the length of the side of the square which is removed from each corner (in inches), $0 < x < 5$. Solve the inequality $V(x) \geq 80$ analytically and interpret your answer in the context of that example.

⁹You *can* do these without your calculator, but it may test your mettle!

56. From Exercise 32 in Section 3.1, $C(x) = .03x^3 - 4.5x^2 + 225x + 250$, for $x \geq 0$ models the cost, in dollars, to produce x PortaBoy game systems. If the production budget is \$5000, find the number of game systems which can be produced and still remain under budget.
57. Let $f(x) = 5x^7 - 33x^6 + 3x^5 - 71x^4 - 597x^3 + 2097x^2 - 1971x + 567$. With the help of your classmates, find the x - and y - intercepts of the graph of f . Find the intervals on which the function is increasing, the intervals on which it is decreasing and the local extrema. Sketch the graph of f , using more than one picture if necessary to show all of the important features of the graph.
58. With the help of your classmates, create a list of five polynomials with different degrees whose real zeros cannot be found using any of the techniques in this section.

3.3.4 ANSWERS

1. For $f(x) = x^3 - 2x^2 - 5x + 6$
 - All of the real zeros lie in the interval $[-7, 7]$
 - Possible rational zeros are $\pm 1, \pm 2, \pm 3, \pm 6$
 - There are 2 or 0 positive real zeros; there is 1 negative real zero
2. For $f(x) = x^4 + 2x^3 - 12x^2 - 40x - 32$
 - All of the real zeros lie in the interval $[-41, 41]$
 - Possible rational zeros are $\pm 1, \pm 2, \pm 4, \pm 8, \pm 16, \pm 32$
 - There is 1 positive real zero; there are 3 or 1 negative real zeros
3. For $f(x) = x^4 - 9x^2 - 4x + 12$
 - All of the real zeros lie in the interval $[-13, 13]$
 - Possible rational zeros are $\pm 1, \pm 2, \pm 3, \pm 4, \pm 6, \pm 12$
 - There are 2 or 0 positive real zeros; there are 2 or 0 negative real zeros
4. For $f(x) = x^3 + 4x^2 - 11x + 6$
 - All of the real zeros lie in the interval $[-12, 12]$
 - Possible rational zeros are $\pm 1, \pm 2, \pm 3, \pm 6$
 - There are 2 or 0 positive real zeros; there is 1 negative real zero
5. For $f(x) = x^3 - 7x^2 + x - 7$
 - All of the real zeros lie in the interval $[-8, 8]$
 - Possible rational zeros are $\pm 1, \pm 7$
 - There are 3 or 1 positive real zeros; there are no negative real zeros
6. For $f(x) = -2x^3 + 19x^2 - 49x + 20$
 - All of the real zeros lie in the interval $[-\frac{51}{2}, \frac{51}{2}]$
 - Possible rational zeros are $\pm\frac{1}{2}, \pm 1, \pm 2, \pm\frac{5}{2}, \pm 4, \pm 5, \pm 10, \pm 20$
 - There are 3 or 1 positive real zeros; there are no negative real zeros
7. For $f(x) = -17x^3 + 5x^2 + 34x - 10$
 - All of the real zeros lie in the interval $[-3, 3]$
 - Possible rational zeros are $\pm\frac{1}{17}, \pm\frac{2}{17}, \pm\frac{5}{17}, \pm\frac{10}{17}, \pm 1, \pm 2, \pm 5, \pm 10$
 - There are 2 or 0 positive real zeros; there is 1 negative real zero

8. For $f(x) = 36x^4 - 12x^3 - 11x^2 + 2x + 1$
- All of the real zeros lie in the interval $[-\frac{4}{3}, \frac{4}{3}]$
 - Possible rational zeros are $\pm\frac{1}{36}, \pm\frac{1}{18}, \pm\frac{1}{12}, \pm\frac{1}{9}, \pm\frac{1}{6}, \pm\frac{1}{4}, \pm\frac{1}{3}, \pm\frac{1}{2}, \pm 1$
 - There are 2 or 0 positive real zeros; there are 2 or 0 negative real zeros
9. For $f(x) = 3x^3 + 3x^2 - 11x - 10$
- All of the real zeros lie in the interval $[-\frac{14}{3}, \frac{14}{3}]$
 - Possible rational zeros are $\pm\frac{1}{3}, \pm\frac{2}{3}, \pm\frac{5}{3}, \pm\frac{10}{3}, \pm 1, \pm 2, \pm 5, \pm 10$
 - There is 1 positive real zero; there are 2 or 0 negative real zeros
10. For $f(x) = 2x^4 + x^3 - 7x^2 - 3x + 3$
- All of the real zeros lie in the interval $[-\frac{9}{2}, \frac{9}{2}]$
 - Possible rational zeros are $\pm\frac{1}{2}, \pm 1, \pm\frac{3}{2}, \pm 3$
 - There are 2 or 0 positive real zeros; there are 2 or 0 negative real zeros
11. $f(x) = x^3 - 2x^2 - 5x + 6$
 $x = -2, x = 1, x = 3$ (each has mult. 1)
12. $f(x) = x^4 + 2x^3 - 12x^2 - 40x - 32$
 $x = -2$ (mult. 3), $x = 4$ (mult. 1)
13. $f(x) = x^4 - 9x^2 - 4x + 12$
 $x = -2$ (mult. 2), $x = 1$ (mult. 1), $x = 3$ (mult. 1)
14. $f(x) = x^3 + 4x^2 - 11x + 6$
 $x = -6$ (mult. 1), $x = 1$ (mult. 2)
15. $f(x) = x^3 - 7x^2 + x - 7$
 $x = 7$ (mult. 1)
16. $f(x) = -2x^3 + 19x^2 - 49x + 20$
 $x = \frac{1}{2}, x = 4, x = 5$ (each has mult. 1)
17. $f(x) = -17x^3 + 5x^2 + 34x - 10$
 $x = \frac{5}{17}, x = \pm\sqrt{2}$ (each has mult. 1)
18. $f(x) = 36x^4 - 12x^3 - 11x^2 + 2x + 1$
 $x = \frac{1}{2}$ (mult. 2), $x = -\frac{1}{3}$ (mult. 2)
19. $f(x) = 3x^3 + 3x^2 - 11x - 10$
 $x = -2, x = \frac{3 \pm \sqrt{69}}{6}$ (each has mult. 1)

20. $f(x) = 2x^4 + x^3 - 7x^2 - 3x + 3$
 $x = -1, x = \frac{1}{2}, x = \pm\sqrt{3}$ (each mult. 1)
21. $f(x) = 9x^3 - 5x^2 - x$
 $x = 0, x = \frac{5 \pm \sqrt{61}}{18}$ (each has mult. 1)
22. $f(x) = 6x^4 - 5x^3 - 9x^2$
 $x = 0$ (mult. 2), $x = \frac{5 \pm \sqrt{241}}{12}$ (each has mult. 1)
23. $f(x) = x^4 + 2x^2 - 15$
 $x = \pm\sqrt{3}$ (each has mult. 1)
24. $f(x) = x^4 - 9x^2 + 14$
 $x = \pm\sqrt{2}, x = \pm\sqrt{7}$ (each has mult. 1)
25. $f(x) = 3x^4 - 14x^2 - 5$
 $x = \pm\sqrt{5}$ (each has mult. 1)
26. $f(x) = 2x^4 - 7x^2 + 6$
 $x = \pm\frac{\sqrt{6}}{2}, x = \pm\sqrt{2}$ (each has mult. 1)
27. $f(x) = x^6 - 3x^3 - 10$
 $x = \sqrt[3]{-2} = -\sqrt[3]{2}, x = \sqrt[3]{5}$ (each has mult. 1)
28. $f(x) = 2x^6 - 9x^3 + 10$
 $x = \frac{\sqrt[3]{20}}{2}, x = \sqrt[3]{2}$ (each has mult. 1)
29. $f(x) = x^5 - 2x^4 - 4x + 8$
 $x = 2, x = \pm\sqrt{2}$ (each has mult. 1)
30. $f(x) = 2x^5 + 3x^4 - 18x - 27$
 $x = -\frac{3}{2}, x = \pm\sqrt{3}$ (each has mult. 1)
31. $f(x) = x^5 - 60x^3 - 80x^2 + 960x + 2304$
 $x = -4$ (mult. 3), $x = 6$ (mult. 2)
32. $f(x) = 25x^5 - 105x^4 + 174x^3 - 142x^2 + 57x - 9$
 $x = \frac{3}{5}$ (mult. 2), $x = 1$ (mult. 3)
33. $f(x) = 90x^4 - 399x^3 + 622x^2 - 399x + 90$
 $x = \frac{2}{3}, x = \frac{3}{2}, x = \frac{5}{3}, x = \frac{3}{5}$ (each has mult. 1)
34. We choose $q(x) = 72x^3 - 6x^2 - 7x + 1 = 72 \cdot f(x)$. Clearly $f(x) = 0$ if and only if $q(x) = 0$ so they have the same real zeros. In this case, $x = -\frac{1}{3}, x = \frac{1}{6}$ and $x = \frac{1}{4}$ are the real zeros of both f and q .

35. $x = 0, \frac{5 \pm \sqrt{61}}{18}$
36. $x = 0, \frac{5 \pm \sqrt{241}}{12}$
37. $x = -2, 1, 3$
38. $x = -2, 4$
39. $x = 7$
40. $x = \frac{1}{2}, 4, 5$
41. $x = -2, \frac{3 \pm \sqrt{69}}{6}$
42. $x = \pm\sqrt{3}$
43. $x = \pm\sqrt{5}$
44. $x = -\frac{3}{2}, \pm\sqrt{3}$
45. $(-\infty, \frac{1}{2}) \cup (4, 5)$
46. $\{-2\} \cup [1, 3]$
47. $(-\infty, -1] \cup [3, \infty)$
48. $\left\{-\frac{1}{2}\right\} \cup [1, \infty)$
49. $[-2, 2]$
50. $(-\infty, -1) \cup (-1, 0) \cup (2, \infty)$
51. $(-\infty, -2) \cup (-\sqrt{2}, \sqrt{2})$
52. $\{2\} \cup [4, \infty)$
53. $(-\infty, -\sqrt{3}) \cup (\sqrt{3}, \infty)$
54. $(-\infty, -\sqrt[3]{3}) \cup (\sqrt[3]{2}, \infty)$
55. $V(x) \geq 80$ on $[1, 5 - \sqrt{5}] \cup [5 + \sqrt{5}, \infty)$. Only the portion $[1, 5 - \sqrt{5}]$ lies in the applied domain, however. In the context of the problem, this says for the volume of the box to be at least 80 cubic inches, the square removed from each corner needs to have a side length of at least 1 inch, but no more than $5 - \sqrt{5} \approx 2.76$ inches.
56. $C(x) \leq 5000$ on (approximately) $(-\infty, 82.18]$. The portion of this which lies in the applied domain is $(0, 82.18]$. Since x represents the number of game systems, we check $C(82) = 4983.04$ and $C(83) = 5078.11$, so to remain within the production budget, anywhere between 1 and 82 game systems can be produced.

3.4 COMPLEX ZEROS AND THE FUNDAMENTAL THEOREM OF ALGEBRA

In Section 3.3, we were focused on finding the real zeros of a polynomial function. In this section, we expand our horizons and look for the non-real zeros as well. Consider the polynomial $p(x) = x^2 + 1$. The zeros of p are the solutions to $x^2 + 1 = 0$, or $x^2 = -1$. This equation has no real solutions, but you may recall from Intermediate Algebra that we can formally extract the square roots of both sides to get $x = \pm\sqrt{-1}$. The quantity $\sqrt{-1}$ is usually re-labeled i , the so-called **imaginary unit**.¹ The number i , while not a real number, plays along well with real numbers, and acts very much like any other radical expression. For instance, $3(2i) = 6i$, $7i - 3i = 4i$, $(2 - 7i) + (3 + 4i) = 5 - 3i$, and so forth. The key properties which distinguish i from the real numbers are listed below.

Definition 3.4. The imaginary unit i satisfies the two following properties

1. $i^2 = -1$
2. If c is a real number with $c \geq 0$ then $\sqrt{-c} = i\sqrt{c}$

Property 1 in Definition 3.4 establishes that i does act as a square root² of -1 , and property 2 establishes what we mean by the ‘principal square root’ of a negative real number. In property 2, it is important to remember the restriction on c . For example, it is perfectly acceptable to say $\sqrt{-4} = i\sqrt{4} = i(2) = 2i$. However, $\sqrt{-(-4)} \neq i\sqrt{-4}$, otherwise, we’d get

$$2 = \sqrt{4} = \sqrt{-(-4)} = i\sqrt{-4} = i(2i) = 2i^2 = 2(-1) = -2,$$

which is unacceptable.³ We are now in the position to define the **complex numbers**.

Definition 3.5. A **complex number** is a number of the form $a + bi$, where a and b are real numbers and i is the imaginary unit.

Complex numbers include things you’d normally expect, like $3 + 2i$ and $\frac{2}{5} - i\sqrt{3}$. However, don’t forget that a or b could be zero, which means numbers like $3i$ and 6 are also complex numbers. In other words, don’t forget that the complex numbers *include* the real numbers, so 0 and $\pi - \sqrt{2}i$ are both considered complex numbers.⁴ The arithmetic of complex numbers is as you would expect. The only things you need to remember are the two properties in Definition 3.4. The next example should help recall how these animals behave.

¹Some Technical Mathematics textbooks label it ‘ j ’.

²Note the use of the indefinite article ‘a’. Whatever beast is chosen to be i , $-i$ is the other square root of -1 .

³We want to enlarge the number system so we can solve things like $x^2 = -1$, but not at the cost of the established rules already set in place. For that reason, the general properties of radicals simply do not apply for even roots of negative quantities.

⁴See the remarks in Section 1.1.1.

Example 3.4.1. Perform the indicated operations. Write your answer in the form⁵ $a + bi$.

1. $(1 - 2i) - (3 + 4i)$
2. $(1 - 2i)(3 + 4i)$
3. $\frac{1 - 2i}{3 - 4i}$
4. $\sqrt{-3}\sqrt{-12}$
5. $\sqrt{(-3)(-12)}$
6. $(x - [1 + 2i])(x - [1 - 2i])$

Solution.

1. As mentioned earlier, we treat expressions involving i as we would any other radical. We combine like terms to get $(1 - 2i) - (3 + 4i) = 1 - 2i - 3 - 4i = -2 - 6i$.
2. Using the distributive property, we get $(1 - 2i)(3 + 4i) = (1)(3) + (1)(4i) - (2i)(3) - (2i)(4i) = 3 + 4i - 6i - 8i^2$. Since $i^2 = -1$, we get $3 + 4i - 6i - 8i^2 = 3 - 2i - (-8) = 11 - 2i$.
3. How in the world are we supposed to simplify $\frac{1-2i}{3-4i}$? Well, we deal with the denominator $3 - 4i$ as we would any other denominator containing a radical, and multiply both numerator and denominator by $3 + 4i$ (the conjugate of $3 - 4i$).⁶ Doing so produces

$$\frac{1 - 2i}{3 - 4i} \cdot \frac{3 + 4i}{3 + 4i} = \frac{(1 - 2i)(3 + 4i)}{(3 - 4i)(3 + 4i)} = \frac{11 - 2i}{25} = \frac{11}{25} - \frac{2}{25}i$$

4. We use property 2 of Definition 3.4 first, then apply the rules of radicals applicable to real radicals to get $\sqrt{-3}\sqrt{-12} = (i\sqrt{3})(i\sqrt{12}) = i^2\sqrt{3 \cdot 12} = -\sqrt{36} = -6$.
5. We adhere to the order of operations here and perform the multiplication before the radical to get $\sqrt{(-3)(-12)} = \sqrt{36} = 6$.
6. We can brute force multiply using the distributive property and see that

$$\begin{aligned} (x - [1 + 2i])(x - [1 - 2i]) &= x^2 - x[1 - 2i] - x[1 + 2i] + [1 - 2i][1 + 2i] \\ &= x^2 - x + 2ix - x - 2ix + 1 - 2i + 2i - 4i^2 \\ &= x^2 - 2x + 5 \end{aligned}$$

□

A couple of remarks about the last example are in order. First, the **conjugate** of a complex number $a + bi$ is the number $a - bi$. The notation commonly used for conjugation is a ‘bar’: $\overline{a + bi} = a - bi$. For example, $\overline{3 + 2i} = 3 - 2i$, $\overline{3 - 2i} = 3 + 2i$, $\overline{6} = 6$, $\overline{4i} = -4i$, and $\overline{3 + \sqrt{5}} = 3 + \sqrt{5}$. The properties of the conjugate are summarized in the following theorem.

⁵OK, we’ll accept things like $3 - 2i$ even though it can be written as $3 + (-2)i$.

⁶We will talk more about this in a moment.

Theorem 3.12. Properties of the Complex Conjugate: Let z and w be complex numbers.

- $\overline{\overline{z}} = z$
- $\overline{z + w} = \overline{z} + \overline{w}$
- $\overline{z \overline{w}} = z w$
- $(\overline{z})^n = \overline{z^n}$, for any natural number n
- z is a real number if and only if $\overline{z} = z$.

Essentially, Theorem 3.12 says that complex conjugation works well with addition, multiplication and powers. The proof of these properties can best be achieved by writing out $z = a + bi$ and $w = c + di$ for real numbers a, b, c and d . Next, we compute the left and right hand sides of each equation and check to see that they are the same. The proof of the first property is a very quick exercise.⁷ To prove the second property, we compare $\overline{z + w}$ and $\overline{z} + \overline{w}$. We have $\overline{z + w} = \overline{a + bi + c + di} = a - bi + c - di$. To find $\overline{z + w}$, we first compute

$$z + w = (a + bi) + (c + di) = (a + c) + (b + d)i$$

so

$$\overline{z + w} = \overline{(a + c) + (b + d)i} = (a + c) - (b + d)i = a - bi + c - di$$

As such, we have established $\overline{\overline{z + w}} = z + w$. The proof for multiplication works similarly. The proof that the conjugate works well with powers can be viewed as a repeated application of the product rule, and is best proved using a technique called Mathematical Induction. The last property is a characterization of real numbers. If z is real, then $z = a + 0i$, so $\overline{z} = a - 0i = a = z$. On the other hand, if $z = \overline{z}$, then $a + bi = a - bi$ which means $b = -b$ so $b = 0$. Hence, $z = a + 0i = a$ and is real.

We now return to the business of zeros. Suppose we wish to find the zeros of $f(x) = x^2 - 2x + 5$. To solve the equation $x^2 - 2x + 5 = 0$, we note that the quadratic doesn't factor nicely, so we resort to the Quadratic Formula, Equation 2.5 and obtain

$$x = \frac{-(-2) \pm \sqrt{(-2)^2 - 4(1)(5)}}{2(1)} = \frac{2 \pm \sqrt{-16}}{2} = \frac{2 \pm 4i}{2} = 1 \pm 2i.$$

Two things are important to note. First, the zeros $1 + 2i$ and $1 - 2i$ are complex conjugates. If ever we obtain non-real zeros to a quadratic function with real coefficients, the zeros will be a complex conjugate pair. (Do you see why?) Next, we note that in Example 3.4.1, part 6, we found $(x - [1 + 2i])(x - [1 - 2i]) = x^2 - 2x + 5$. This demonstrates that the factor theorem holds even for non-real zeros, i.e, $x = 1 + 2i$ is a zero of f , and, sure enough, $(x - [1 + 2i])$ is a factor of $f(x)$. It turns out that polynomial division works the same way for all complex numbers, real and non-real alike, so the Factor and Remainder Theorems hold as well. But how do we know if a general polynomial has any complex zeros at all? We have many examples of polynomials with no

⁷Trust us on this.

real zeros. Can there be polynomials with no zeros whatsoever? The answer to that last question is “No.” and the theorem which provides that answer is The Fundamental Theorem of Algebra.

Theorem 3.13. The Fundamental Theorem of Algebra: Suppose f is a polynomial function with complex number coefficients of degree $n \geq 1$, then f has at least one complex zero.

The Fundamental Theorem of Algebra is an example of an ‘existence’ theorem in Mathematics. Like the Intermediate Value Theorem, Theorem 3.1, the Fundamental Theorem of Algebra guarantees the existence of at least one zero, but gives us no algorithm to use in finding it. In fact, as we mentioned in Section 3.3, there are polynomials whose real zeros, though they exist, cannot be expressed using the ‘usual’ combinations of arithmetic symbols, and must be approximated. The authors are fully aware that the full impact and profound nature of the Fundamental Theorem of Algebra is lost on most students studying College Algebra, and that’s fine. It took mathematicians literally hundreds of years to prove the theorem in its full generality, and some of that history is recorded [here](#). Note that the Fundamental Theorem of Algebra applies to not only polynomial functions with real coefficients, but to those with complex number coefficients as well.

Suppose f is a polynomial of degree $n \geq 1$. The Fundamental Theorem of Algebra guarantees us at least one complex zero, z_1 , and as such, the Factor Theorem guarantees that $f(x)$ factors as $f(x) = (x - z_1)q_1(x)$ for a polynomial function q_1 , of degree exactly $n - 1$. If $n - 1 \geq 1$, then the Fundamental Theorem of Algebra guarantees a complex zero of q_1 as well, say z_2 , so then the Factor Theorem gives us $q_1(x) = (x - z_2)q_2(x)$, and hence $f(x) = (x - z_1)(x - z_2)q_2(x)$. We can continue this process exactly n times, at which point our quotient polynomial q_n has degree 0 so it’s a constant. This argument gives us the following factorization theorem.

Theorem 3.14. Complex Factorization Theorem: Suppose f is a polynomial function with complex number coefficients. If the degree of f is n and $n \geq 1$, then f has exactly n complex zeros, counting multiplicity. If z_1, z_2, \dots, z_k are the distinct zeros of f , with multiplicities m_1, m_2, \dots, m_k , respectively, then $f(x) = a(x - z_1)^{m_1}(x - z_2)^{m_2} \dots (x - z_k)^{m_k}$.

Note that the value a in Theorem 3.14 is the leading coefficient of $f(x)$ (Can you see why?) and as such, we see that a polynomial is completely determined by its zeros, their multiplicities, and its leading coefficient. We put this theorem to good use in the next example.

Example 3.4.2. Let $f(x) = 12x^5 - 20x^4 + 19x^3 - 6x^2 - 2x + 1$.

1. Find all of the complex zeros of f and state their multiplicities.
2. Factor $f(x)$ using Theorem 3.14

Solution.

1. Since f is a fifth degree polynomial, we know that we need to perform at least three successful divisions to get the quotient down to a quadratic function. At that point, we can find the remaining zeros using the Quadratic Formula, if necessary. Using the techniques developed in Section 3.3, we get

$$\begin{array}{r|rrrrrr}
\frac{1}{2} & 12 & -20 & 19 & -6 & -2 & 1 \\
& \downarrow & 6 & -7 & 6 & 0 & -1 \\
\hline
\frac{1}{2} & 12 & -14 & 12 & 0 & -2 & \boxed{0} \\
& \downarrow & 6 & -4 & 4 & 2 & \\
\hline
-\frac{1}{3} & 12 & -8 & 8 & 4 & \boxed{0} & \\
& \downarrow & -4 & 4 & -4 & & \\
\hline
& 12 & -12 & 12 & \boxed{0} & &
\end{array}$$

Our quotient is $12x^2 - 12x + 12$, whose zeros we find to be $\frac{1 \pm i\sqrt{3}}{2}$. From Theorem 3.14, we know f has exactly 5 zeros, counting multiplicities, and as such we have the zero $\frac{1}{2}$ with multiplicity 2, and the zeros $-\frac{1}{3}$, $\frac{1+i\sqrt{3}}{2}$ and $\frac{1-i\sqrt{3}}{2}$, each of multiplicity 1.

2. Applying Theorem 3.14, we are guaranteed that f factors as

$$f(x) = 12 \left(x - \frac{1}{2}\right)^2 \left(x + \frac{1}{3}\right) \left(x - \left[\frac{1+i\sqrt{3}}{2}\right]\right) \left(x - \left[\frac{1-i\sqrt{3}}{2}\right]\right) \quad \square$$

A true test of Theorem 3.14 (and a student's mettle!) would be to take the factored form of $f(x)$ in the previous example and multiply it out⁸ to see that it really does reduce to the original formula $f(x) = 12x^5 - 20x^4 + 19x^3 - 6x^2 - 2x + 1$. When factoring a polynomial using Theorem 3.14, we say that it is **factored completely over the complex numbers**, meaning that it is impossible to factor the polynomial any further using complex numbers. If we wanted to completely factor $f(x)$ over the **real numbers** then we would have stopped short of finding the nonreal zeros of f and factored f using our work from the synthetic division to write $f(x) = (x - \frac{1}{2})^2 (x + \frac{1}{3}) (12x^2 - 12x + 12)$, or $f(x) = 12 (x - \frac{1}{2})^2 (x + \frac{1}{3}) (x^2 - x + 1)$. Since the zeros of $x^2 - x + 1$ are nonreal, we call $x^2 - x + 1$ an **irreducible quadratic** meaning it is impossible to break it down any further using *real* numbers.

The last two results of the section show us that, at least in theory, if we have a polynomial function with real coefficients, we can always factor it down enough so that any nonreal zeros come from irreducible quadratics.

Theorem 3.15. Conjugate Pairs Theorem: If f is a polynomial function with real number coefficients and z is a zero of f , then so is \bar{z} .

To prove the theorem, suppose f is a polynomial with real number coefficients. Specifically, let $f(x) = a_n x^n + a_{n-1} x^{n-1} + \dots + a_2 x^2 + a_1 x + a_0$. If z is a zero of f , then $f(z) = 0$, which means $a_n z^n + a_{n-1} z^{n-1} + \dots + a_2 z^2 + a_1 z + a_0 = 0$. Next, we consider $f(\bar{z})$ and apply Theorem 3.12 below.

⁸You really should do this once in your life to convince yourself that all of the theory actually does work!

$$\begin{aligned}
f(\bar{z}) &= a_n (\bar{z})^n + a_{n-1} (\bar{z})^{n-1} + \dots + a_2 (\bar{z})^2 + a_1 \bar{z} + a_0 \\
&= a_n \overline{z^n} + a_{n-1} \overline{z^{n-1}} + \dots + a_2 \overline{z^2} + a_1 \bar{z} + a_0 && \text{since } (\bar{z})^n = \overline{z^n} \\
&= \overline{a_n z^n} + \overline{a_{n-1} z^{n-1}} + \dots + \overline{a_2 z^2} + \overline{a_1 z} + \overline{a_0} && \text{since the coefficients are real} \\
&= \overline{a_n z^n + a_{n-1} z^{n-1} + \dots + a_2 z^2 + a_1 z + a_0} && \text{since } \bar{z} \bar{w} = \overline{z w} \\
&= \overline{f(z)} && \text{since } \bar{z} + \bar{w} = \overline{z + w} \\
&= \bar{0} \\
&= 0
\end{aligned}$$

This shows that \bar{z} is a zero of f . So, if f is a polynomial function with real number coefficients, Theorem 3.15 tells us that if $a + bi$ is a nonreal zero of f , then so is $a - bi$. In other words, nonreal zeros of f come in conjugate pairs. The Factor Theorem kicks in to give us both $(x - [a + bi])$ and $(x - [a - bi])$ as factors of $f(x)$ which means $(x - [a + bi])(x - [a - bi]) = x^2 + 2ax + (a^2 + b^2)$ is an irreducible quadratic factor of f . As a result, we have our last theorem of the section.

Theorem 3.16. Real Factorization Theorem: Suppose f is a polynomial function with real number coefficients. Then $f(x)$ can be factored into a product of linear factors corresponding to the real zeros of f and irreducible quadratic factors which give the nonreal zeros of f .

We now present an example which pulls together all of the major ideas of this section.

Example 3.4.3. Let $f(x) = x^4 + 64$.

1. Use synthetic division to show that $x = 2 + 2i$ is a zero of f .
2. Find the remaining complex zeros of f .
3. Completely factor $f(x)$ over the complex numbers.
4. Completely factor $f(x)$ over the real numbers.

Solution.

1. Remembering to insert the 0's in the synthetic division tableau we have

$$\begin{array}{r|rrrrr}
2 + 2i & 1 & 0 & 0 & 0 & 64 \\
& \downarrow & 2 + 2i & 8i & -16 + 16i & -64 \\
\hline
& 1 & 2 + 2i & 8i & -16 + 16i & \boxed{0}
\end{array}$$

2. Since f is a fourth degree polynomial, we need to make two successful divisions to get a quadratic quotient. Since $2 + 2i$ is a zero, we know from Theorem 3.15 that $2 - 2i$ is also a zero. We continue our synthetic division tableau.

$$\begin{array}{r|rrrrr}
2 + 2i & 1 & 0 & 0 & 0 & 64 \\
& \downarrow & 2 + 2i & 8i & -16 + 16i & -64 \\
2 - 2i & 1 & 2 + 2i & 8i & -16 + 16i & \boxed{0} \\
& \downarrow & 2 - 2i & 8 - 8i & 16 - 16i & \\
\hline
& 1 & 4 & 8 & & \boxed{0}
\end{array}$$

Our quotient polynomial is $x^2 + 4x + 8$. Using the quadratic formula, we obtain the remaining zeros $-2 + 2i$ and $-2 - 2i$.

3. Using Theorem 3.14, we get $f(x) = (x - [2 - 2i])(x - [2 + 2i])(x - [-2 + 2i])(x - [-2 - 2i])$.
4. We multiply the linear factors of $f(x)$ which correspond to complex conjugate pairs. We find $(x - [2 - 2i])(x - [2 + 2i]) = x^2 - 4x + 8$, and $(x - [-2 + 2i])(x - [-2 - 2i]) = x^2 + 4x + 8$. Our final answer is $f(x) = (x^2 - 4x + 8)(x^2 + 4x + 8)$. \square

Our last example turns the tables and asks us to manufacture a polynomial with certain properties of its graph and zeros.

Example 3.4.4. Find a polynomial p of lowest degree that has integer coefficients and satisfies all of the following criteria:

- the graph of $y = p(x)$ touches (but doesn't cross) the x -axis at $(\frac{1}{3}, 0)$
- $x = 3i$ is a zero of p .
- as $x \rightarrow -\infty$, $p(x) \rightarrow -\infty$
- as $x \rightarrow \infty$, $p(x) \rightarrow -\infty$

Solution. To solve this problem, we will need a good understanding of the relationship between the x -intercepts of the graph of a function and the zeros of a function, the Factor Theorem, the role of multiplicity, complex conjugates, the Complex Factorization Theorem, and end behavior of polynomial functions. (In short, you'll need most of the major concepts of this chapter.) Since the graph of p touches the x -axis at $(\frac{1}{3}, 0)$, we know $x = \frac{1}{3}$ is a zero of even multiplicity. Since we are after a polynomial of lowest degree, we need $x = \frac{1}{3}$ to have multiplicity exactly 2. The Factor Theorem now tells us $(x - \frac{1}{3})^2$ is a factor of $p(x)$. Since $x = 3i$ is a zero and our final answer is to have integer (real) coefficients, $x = -3i$ is also a zero. The Factor Theorem kicks in again to give us $(x - 3i)$ and $(x + 3i)$ as factors of $p(x)$. We are given no further information about zeros or intercepts so we conclude, by the Complex Factorization Theorem that $p(x) = a(x - \frac{1}{3})^2(x - 3i)(x + 3i)$ for some real number a . Expanding this, we get $p(x) = ax^4 - \frac{2a}{3}x^3 + \frac{82a}{9}x^2 - 6ax + a$. In order to obtain integer coefficients, we know a must be an integer multiple of 9. Our last concern is end behavior. Since the leading term of $p(x)$ is ax^4 , we need $a < 0$ to get $p(x) \rightarrow -\infty$ as $x \rightarrow \pm\infty$. Hence, if we choose $x = -9$, we get $p(x) = -9x^4 + 6x^3 - 82x^2 + 54x - 9$. We can verify our handiwork using the techniques developed in this chapter. \square

This example concludes our study of polynomial functions.⁹ The last few sections have contained what is considered by many to be ‘heavy’ Mathematics. Like a heavy meal, heavy Mathematics takes time to digest. Don’t be overly concerned if it doesn’t seem to sink in all at once, and pace yourself in the Exercises or you’re liable to get mental cramps. But before we get to the Exercises, we’d like to offer a bit of an epilogue.

Our main goal in presenting the material on the complex zeros of a polynomial was to give the chapter a sense of completeness. Given that it can be shown that some polynomials have real zeros which cannot be expressed using the usual algebraic operations, and still others have no real zeros at all, it was nice to discover that every polynomial of degree $n \geq 1$ has n complex zeros. So like we said, it gives us a sense of closure. But the observant reader will note that we did not give any examples of applications which involve complex numbers. Students often wonder when complex numbers will be used in ‘real-world’ applications. After all, didn’t we call i the imaginary unit? How can imaginary things be used in reality? It turns out that complex numbers are very useful in many applied fields such as fluid dynamics, electromagnetism and quantum mechanics, but most of the applications require Mathematics well beyond College Algebra to fully understand them. That does not mean you’ll never be able to understand them; in fact, it is the authors’ sincere hope that all of you will reach a point in your studies when the glory, awe and splendor of complex numbers are revealed to you. For now, however, the really good stuff is beyond the scope of this text. We invite you and your classmates to find a few examples of complex number applications and see what you can make of them. A simple Internet search with the phrase ‘complex numbers in real life’ should get you started. Basic electronics classes are another place to look, but remember, they might use the letter j where we have used i .

For the remainder of the text, with the exception of a few exploratory exercises scattered about, we will restrict our attention to real numbers. We do this primarily because the first Calculus sequence you will take, ostensibly the one that this text is preparing you for, studies only functions of real variables. Also, lots of really cool scientific things don’t require any deep understanding of complex numbers to study them, but they do need more Mathematics like exponential, logarithmic and trigonometric functions. We believe it makes more sense pedagogically for you to learn about those functions now then take a course in Complex Function Theory in your junior or senior year once you’ve completed the Calculus sequence. It is in that course that the true power of the complex numbers is released. But for now, in order to fully prepare you for life immediately after College Algebra, we will say that functions like $f(x) = \frac{1}{x^2+1}$ have a domain of all real numbers, even though we know $x^2 + 1 = 0$ has two complex solutions, namely $x = \pm i$. Because $x^2 + 1 > 0$ for all *real* numbers x , the fraction $\frac{1}{x^2+1}$ is never undefined in the real variable setting.

⁹With the exception of the Exercises on the next page, of course.

3.4.1 EXERCISES

In Exercises 1 - 10, use the given complex numbers z and w to find and simplify the following. Write your answers in the form $a + bi$.

- | | | |
|-----------------|-----------------|-----------------|
| • $z + w$ | • zw | • z^2 |
| • $\frac{1}{z}$ | • $\frac{z}{w}$ | • $\frac{w}{z}$ |
| • \bar{z} | • $z\bar{z}$ | • $(\bar{z})^2$ |

1. $z = 2 + 3i, w = 4i$

2. $z = 1 + i, w = -i$

3. $z = i, w = -1 + 2i$

4. $z = 4i, w = 2 - 2i$

5. $z = 3 - 5i, w = 2 + 7i$

6. $z = -5 + i, w = 4 + 2i$

7. $z = \sqrt{2} - i\sqrt{2}, w = \sqrt{2} + i\sqrt{2}$

8. $z = 1 - i\sqrt{3}, w = -1 - i\sqrt{3}$

9. $z = \frac{1}{2} + \frac{\sqrt{3}}{2}i, w = -\frac{1}{2} + \frac{\sqrt{3}}{2}i$

10. $z = -\frac{\sqrt{2}}{2} + \frac{\sqrt{2}}{2}i, w = -\frac{\sqrt{2}}{2} - \frac{\sqrt{2}}{2}i$

In Exercises 11 - 18, simplify the quantity.

11. $\sqrt{-49}$

12. $\sqrt{-9}$

13. $\sqrt{-25}\sqrt{-4}$

14. $\sqrt{(-25)(-4)}$

15. $\sqrt{-9}\sqrt{-16}$

16. $\sqrt{(-9)(-16)}$

17. $\sqrt{-(-9)}$

18. $-\sqrt{(-9)}$

We know that $i^2 = -1$ which means $i^3 = i^2 \cdot i = (-1) \cdot i = -i$ and $i^4 = i^2 \cdot i^2 = (-1)(-1) = 1$. In Exercises 19 - 26, use this information to simplify the given power of i .

19. i^5

20. i^6

21. i^7

22. i^8

23. i^{15}

24. i^{26}

25. i^{117}

26. i^{304}

In Exercises 27 - 48, find all of the zeros of the polynomial then completely factor it over the real numbers and completely factor it over the complex numbers.

27. $f(x) = x^2 - 4x + 13$

28. $f(x) = x^2 - 2x + 5$

29. $f(x) = 3x^2 + 2x + 10$

30. $f(x) = x^3 - 2x^2 + 9x - 18$

31. $f(x) = x^3 + 6x^2 + 6x + 5$

32. $f(x) = 3x^3 - 13x^2 + 43x - 13$

33. $f(x) = x^3 + 3x^2 + 4x + 12$

34. $f(x) = 4x^3 - 6x^2 - 8x + 15$

35. $f(x) = x^3 + 7x^2 + 9x - 2$

36. $f(x) = 9x^3 + 2x + 1$

37. $f(x) = 4x^4 - 4x^3 + 13x^2 - 12x + 3$

38. $f(x) = 2x^4 - 7x^3 + 14x^2 - 15x + 6$

39. $f(x) = x^4 + x^3 + 7x^2 + 9x - 18$

40. $f(x) = 6x^4 + 17x^3 - 55x^2 + 16x + 12$

41. $f(x) = -3x^4 - 8x^3 - 12x^2 - 12x - 5$

42. $f(x) = 8x^4 + 50x^3 + 43x^2 + 2x - 4$

43. $f(x) = x^4 + 9x^2 + 20$

44. $f(x) = x^4 + 5x^2 - 24$

45. $f(x) = x^5 - x^4 + 7x^3 - 7x^2 + 12x - 12$

46. $f(x) = x^6 - 64$

47. $f(x) = x^4 - 2x^3 + 27x^2 - 2x + 26$ (Hint: $x = i$ is one of the zeros.)

48. $f(x) = 2x^4 + 5x^3 + 13x^2 + 7x + 5$ (Hint: $x = -1 + 2i$ is a zero.)

In Exercises 49 - 53, create a polynomial f with real number coefficients which has all of the desired characteristics. You may leave the polynomial in factored form.

49.
 - The zeros of f are $c = \pm 1$ and $c = \pm i$
 - The leading term of $f(x)$ is $42x^4$
50.
 - $c = 2i$ is a zero.
 - the point $(-1, 0)$ is a local minimum on the graph of $y = f(x)$
 - the leading term of $f(x)$ is $117x^4$
51.
 - The solutions to $f(x) = 0$ are $x = \pm 2$ and $x = \pm 7i$
 - The leading term of $f(x)$ is $-3x^5$
 - The point $(2, 0)$ is a local maximum on the graph of $y = f(x)$.
52.
 - f is degree 5.
 - $x = 6$, $x = i$ and $x = 1 - 3i$ are zeros of f
 - as $x \rightarrow -\infty$, $f(x) \rightarrow \infty$
53.
 - The leading term of $f(x)$ is $-2x^3$
 - $c = 2i$ is a zero
 - $f(0) = -16$

54. Let z and w be arbitrary complex numbers. Show that $\overline{z\overline{w}} = \overline{z\overline{w}}$ and $\overline{\overline{z}} = z$.

3.4.2 ANSWERS

1. For $z = 2 + 3i$ and $w = 4i$

- $z + w = 2 + 7i$
- $zw = -12 + 8i$
- $z^2 = -5 + 12i$
- $\frac{1}{z} = \frac{2}{13} - \frac{3}{13}i$
- $\frac{z}{w} = \frac{3}{4} - \frac{1}{2}i$
- $\frac{w}{z} = \frac{12}{13} + \frac{8}{13}i$
- $\bar{z} = 2 - 3i$
- $z\bar{z} = 13$
- $(\bar{z})^2 = -5 - 12i$

2. For $z = 1 + i$ and $w = -i$

- $z + w = 1$
- $zw = 1 - i$
- $z^2 = 2i$
- $\frac{1}{z} = \frac{1}{2} - \frac{1}{2}i$
- $\frac{z}{w} = -1 + i$
- $\frac{w}{z} = -\frac{1}{2} - \frac{1}{2}i$
- $\bar{z} = 1 - i$
- $z\bar{z} = 2$
- $(\bar{z})^2 = -2i$

3. For $z = i$ and $w = -1 + 2i$

- $z + w = -1 + 3i$
- $zw = -2 - i$
- $z^2 = -1$
- $\frac{1}{z} = -i$
- $\frac{z}{w} = \frac{2}{5} - \frac{1}{5}i$
- $\frac{w}{z} = 2 + i$
- $\bar{z} = -i$
- $z\bar{z} = 1$
- $(\bar{z})^2 = -1$

4. For $z = 4i$ and $w = 2 - 2i$

- $z + w = 2 + 2i$
- $zw = 8 + 8i$
- $z^2 = -16$
- $\frac{1}{z} = -\frac{1}{4}i$
- $\frac{z}{w} = -1 + i$
- $\frac{w}{z} = -\frac{1}{2} - \frac{1}{2}i$
- $\bar{z} = -4i$
- $z\bar{z} = 16$
- $(\bar{z})^2 = -16$

5. For $z = 3 - 5i$ and $w = 2 + 7i$

- $z + w = 5 + 2i$
- $zw = 41 + 11i$
- $z^2 = -16 - 30i$
- $\frac{1}{z} = \frac{3}{34} + \frac{5}{34}i$
- $\frac{z}{w} = -\frac{29}{53} - \frac{31}{53}i$
- $\frac{w}{z} = -\frac{29}{34} + \frac{31}{34}i$
- $\bar{z} = 3 + 5i$
- $z\bar{z} = 34$
- $(\bar{z})^2 = -16 + 30i$

6. For $z = -5 + i$ and $w = 4 + 2i$

• $z + w = -1 + 3i$	• $zw = -22 - 6i$	• $z^2 = 24 - 10i$
• $\frac{1}{z} = -\frac{5}{26} - \frac{1}{26}i$	• $\frac{z}{w} = -\frac{9}{10} + \frac{7}{10}i$	• $\frac{w}{z} = -\frac{9}{13} - \frac{7}{13}i$
• $\bar{z} = -5 - i$	• $z\bar{z} = 26$	• $(\bar{z})^2 = 24 + 10i$

7. For $z = \sqrt{2} - i\sqrt{2}$ and $w = \sqrt{2} + i\sqrt{2}$

• $z + w = 2\sqrt{2}$	• $zw = 4$	• $z^2 = -4i$
• $\frac{1}{z} = \frac{\sqrt{2}}{4} + \frac{\sqrt{2}}{4}i$	• $\frac{z}{w} = -i$	• $\frac{w}{z} = i$
• $\bar{z} = \sqrt{2} + i\sqrt{2}$	• $z\bar{z} = 4$	• $(\bar{z})^2 = 4i$

8. For $z = 1 - i\sqrt{3}$ and $w = -1 - i\sqrt{3}$

• $z + w = -2i\sqrt{3}$	• $zw = -4$	• $z^2 = -2 - 2i\sqrt{3}$
• $\frac{1}{z} = \frac{1}{4} + \frac{\sqrt{3}}{4}i$	• $\frac{z}{w} = \frac{1}{2} + \frac{\sqrt{3}}{2}i$	• $\frac{w}{z} = \frac{1}{2} - \frac{\sqrt{3}}{2}i$
• $\bar{z} = 1 + i\sqrt{3}$	• $z\bar{z} = 4$	• $(\bar{z})^2 = -2 + 2i\sqrt{3}$

9. For $z = \frac{1}{2} + \frac{\sqrt{3}}{2}i$ and $w = -\frac{1}{2} + \frac{\sqrt{3}}{2}i$

• $z + w = i\sqrt{3}$	• $zw = -1$	• $z^2 = -\frac{1}{2} + \frac{\sqrt{3}}{2}i$
• $\frac{1}{z} = \frac{1}{2} - \frac{\sqrt{3}}{2}i$	• $\frac{z}{w} = \frac{1}{2} - \frac{\sqrt{3}}{2}i$	• $\frac{w}{z} = \frac{1}{2} + \frac{\sqrt{3}}{2}i$
• $\bar{z} = \frac{1}{2} - \frac{\sqrt{3}}{2}i$	• $z\bar{z} = 1$	• $(\bar{z})^2 = -\frac{1}{2} - \frac{\sqrt{3}}{2}i$

10. For $z = -\frac{\sqrt{2}}{2} + \frac{\sqrt{2}}{2}i$ and $w = -\frac{\sqrt{2}}{2} - \frac{\sqrt{2}}{2}i$

• $-\sqrt{2}$	• $zw = 1$	• $z^2 = -i$
• $\frac{1}{z} = -\frac{\sqrt{2}}{2} - \frac{\sqrt{2}}{2}i$	• $\frac{z}{w} = -i$	• $\frac{w}{z} = i$
• $\bar{z} = -\frac{\sqrt{2}}{2} - \frac{\sqrt{2}}{2}i$	• $z\bar{z} = 1$	• $(\bar{z})^2 = i$

11. $7i$

12. $3i$

13. -10

14. 10

15. -12

16. 12

17. 3

18. $-3i$

19. $i^5 = i^4 \cdot i = 1 \cdot i = i$

20. $i^6 = i^4 \cdot i^2 = 1 \cdot (-1) = -1$

21. $i^7 = i^4 \cdot i^3 = 1 \cdot (-i) = -i$

22. $i^8 = i^4 \cdot i^4 = (i^4)^2 = (1)^2 = 1$

23. $i^{15} = (i^4)^3 \cdot i^3 = 1 \cdot (-i) = -i$

24. $i^{26} = (i^4)^6 \cdot i^2 = 1 \cdot (-1) = -1$

25. $i^{117} = (i^4)^{29} \cdot i = 1 \cdot i = i$

26. $i^{304} = (i^4)^{76} = 1^{76} = 1$

27. $f(x) = x^2 - 4x + 13 = (x - (2 + 3i))(x - (2 - 3i))$

Zeros: $x = 2 \pm 3i$

28. $f(x) = x^2 - 2x + 5 = (x - (1 + 2i))(x - (1 - 2i))$

Zeros: $x = 1 \pm 2i$

29. $f(x) = 3x^2 + 2x + 10 = 3 \left(x - \left(-\frac{1}{3} + \frac{\sqrt{29}}{3}i \right) \right) \left(x - \left(-\frac{1}{3} - \frac{\sqrt{29}}{3}i \right) \right)$

Zeros: $x = -\frac{1}{3} \pm \frac{\sqrt{29}}{3}i$

30. $f(x) = x^3 - 2x^2 + 9x - 18 = (x - 2)(x^2 + 9) = (x - 2)(x - 3i)(x + 3i)$

Zeros: $x = 2, \pm 3i$

31. $f(x) = x^3 + 6x^2 + 6x + 5 = (x + 5)(x^2 + x + 1) = (x + 5) \left(x - \left(-\frac{1}{2} + \frac{\sqrt{3}}{2}i \right) \right) \left(x - \left(-\frac{1}{2} - \frac{\sqrt{3}}{2}i \right) \right)$

Zeros: $x = -5, x = -\frac{1}{2} \pm \frac{\sqrt{3}}{2}i$

32. $f(x) = 3x^3 - 13x^2 + 43x - 13 = (3x - 1)(x^2 - 4x + 13) = (3x - 1)(x - (2 + 3i))(x - (2 - 3i))$

Zeros: $x = \frac{1}{3}, x = 2 \pm 3i$

33. $f(x) = x^3 + 3x^2 + 4x + 12 = (x + 3)(x^2 + 4) = (x + 3)(x + 2i)(x - 2i)$

Zeros: $x = -3, \pm 2i$

34. $f(x) = 4x^3 - 6x^2 - 8x + 15 = \left(x + \frac{3}{2} \right) (4x^2 - 12x + 10)$

$= 4 \left(x + \frac{3}{2} \right) \left(x - \left(\frac{3}{2} + \frac{1}{2}i \right) \right) \left(x - \left(\frac{3}{2} - \frac{1}{2}i \right) \right)$

Zeros: $x = -\frac{3}{2}, x = \frac{3}{2} \pm \frac{1}{2}i$

35. $f(x) = x^3 + 7x^2 + 9x - 2 = (x + 2) \left(x - \left(-\frac{5}{2} + \frac{\sqrt{29}}{2} \right) \right) \left(x - \left(-\frac{5}{2} - \frac{\sqrt{29}}{2} \right) \right)$

Zeros: $x = -2, x = -\frac{5}{2} \pm \frac{\sqrt{29}}{2}$

36. $f(x) = 9x^3 + 2x + 1 = \left(x + \frac{1}{3} \right) (9x^2 - 3x + 3)$

$= 9 \left(x + \frac{1}{3} \right) \left(x - \left(\frac{1}{6} + \frac{\sqrt{11}}{6}i \right) \right) \left(x - \left(\frac{1}{6} - \frac{\sqrt{11}}{6}i \right) \right)$

Zeros: $x = -\frac{1}{3}, x = \frac{1}{6} \pm \frac{\sqrt{11}}{6}i$

37. $f(x) = 4x^4 - 4x^3 + 13x^2 - 12x + 3 = \left(x - \frac{1}{2} \right)^2 (4x^2 + 12) = 4 \left(x - \frac{1}{2} \right)^2 (x + i\sqrt{3})(x - i\sqrt{3})$

Zeros: $x = \frac{1}{2}, x = \pm i\sqrt{3}$

38. $f(x) = 2x^4 - 7x^3 + 14x^2 - 15x + 6 = (x - 1)^2 (2x^2 - 3x + 6)$
 $= 2(x - 1)^2 \left(x - \left(\frac{3}{4} + \frac{\sqrt{39}i}{4} \right) \right) \left(x - \left(\frac{3}{4} - \frac{\sqrt{39}i}{4} \right) \right)$
 Zeros: $x = 1, x = \frac{3}{4} \pm \frac{\sqrt{39}i}{4}$
39. $f(x) = x^4 + x^3 + 7x^2 + 9x - 18 = (x + 2)(x - 1)(x^2 + 9) = (x + 2)(x - 1)(x + 3i)(x - 3i)$
 Zeros: $x = -2, 1, \pm 3i$
40. $f(x) = 6x^4 + 17x^3 - 55x^2 + 16x + 12 = 6 \left(x + \frac{1}{3} \right) \left(x - \frac{3}{2} \right) \left(x - (-2 + 2\sqrt{2}) \right) \left(x - (-2 - 2\sqrt{2}) \right)$
 Zeros: $x = -\frac{1}{3}, x = \frac{3}{2}, x = -2 \pm 2\sqrt{2}$
41. $f(x) = -3x^4 - 8x^3 - 12x^2 - 12x - 5 = (x + 1)^2 (-3x^2 - 2x - 5)$
 $= -3(x + 1)^2 \left(x - \left(-\frac{1}{3} + \frac{\sqrt{14}i}{3} \right) \right) \left(x - \left(-\frac{1}{3} - \frac{\sqrt{14}i}{3} \right) \right)$
 Zeros: $x = -1, x = -\frac{1}{3} \pm \frac{\sqrt{14}i}{3}$
42. $f(x) = 8x^4 + 50x^3 + 43x^2 + 2x - 4 = 8 \left(x + \frac{1}{2} \right) \left(x - \frac{1}{4} \right) \left(x - (-3 + \sqrt{5}) \right) \left(x - (-3 - \sqrt{5}) \right)$
 Zeros: $x = -\frac{1}{2}, \frac{1}{4}, x = -3 \pm \sqrt{5}$
43. $f(x) = x^4 + 9x^2 + 20 = (x^2 + 4)(x^2 + 5) = (x - 2i)(x + 2i)(x - i\sqrt{5})(x + i\sqrt{5})$
 Zeros: $x = \pm 2i, \pm i\sqrt{5}$
44. $f(x) = x^4 + 5x^2 - 24 = (x^2 - 3)(x^2 + 8) = (x - \sqrt{3})(x + \sqrt{3})(x - 2i\sqrt{2})(x + 2i\sqrt{2})$
 Zeros: $x = \pm\sqrt{3}, \pm 2i\sqrt{2}$
45. $f(x) = x^5 - x^4 + 7x^3 - 7x^2 + 12x - 12 = (x - 1)(x^2 + 3)(x^2 + 4)$
 $= (x - 1)(x - i\sqrt{3})(x + i\sqrt{3})(x - 2i)(x + 2i)$
 Zeros: $x = 1, \pm\sqrt{3}i, \pm 2i$
46. $f(x) = x^6 - 64 = (x - 2)(x + 2)(x^2 + 2x + 4)(x^2 - 2x + 4)$
 $= (x - 2)(x + 2) \left(x - (-1 + i\sqrt{3}) \right) \left(x - (-1 - i\sqrt{3}) \right) \left(x - (1 + i\sqrt{3}) \right) \left(x - (1 - i\sqrt{3}) \right)$
 Zeros: $x = \pm 2, x = -1 \pm i\sqrt{3}, x = 1 \pm i\sqrt{3}$
47. $f(x) = x^4 - 2x^3 + 27x^2 - 2x + 26 = (x^2 - 2x + 26)(x^2 + 1) = (x - (1 + 5i))(x - (1 - 5i))(x + i)(x - i)$
 Zeros: $x = 1 \pm 5i, x = \pm i$
48. $f(x) = 2x^4 + 5x^3 + 13x^2 + 7x + 5 = (x^2 + 2x + 5)(2x^2 + x + 1)$
 $= 2(x - (-1 + 2i))(x - (-1 - 2i)) \left(x - \left(-\frac{1}{4} + i\frac{\sqrt{7}}{4} \right) \right) \left(x - \left(-\frac{1}{4} - i\frac{\sqrt{7}}{4} \right) \right)$
 Zeros: $x = -1 \pm 2i, -\frac{1}{4} \pm i\frac{\sqrt{7}}{4}$
49. $f(x) = 42(x - 1)(x + 1)(x - i)(x + i)$
50. $f(x) = 117(x + 1)^2(x - 2i)(x + 2i)$
51. $f(x) = -3(x - 2)^2(x + 2)(x - 7i)(x + 7i)$
52. $f(x) = a(x - 6)(x - i)(x + i)(x - (1 - 3i))(x - (1 + 3i))$ where a is any real number, $a < 0$
53. $f(x) = -2(x - 2i)(x + 2i)(x + 2)$

CHAPTER 4

RATIONAL FUNCTIONS

4.1 INTRODUCTION TO RATIONAL FUNCTIONS

If we add, subtract or multiply polynomial functions according to the function arithmetic rules defined in Section 1.5, we will produce another polynomial function. If, on the other hand, we divide two polynomial functions, the result may not be a polynomial. In this chapter we study **rational functions** - functions which are ratios of polynomials.

Definition 4.1. A **rational function** is a function which is the ratio of polynomial functions. Said differently, r is a rational function if it is of the form

$$r(x) = \frac{p(x)}{q(x)},$$

where p and q are polynomial functions.^a

^aAccording to this definition, all polynomial functions are also rational functions. (Take $q(x) = 1$).

As we recall from Section 1.4, we have domain issues anytime the denominator of a fraction is zero. In the example below, we review this concept as well as some of the arithmetic of rational expressions.

Example 4.1.1. Find the domain of the following rational functions. Write them in the form $\frac{p(x)}{q(x)}$ for polynomial functions p and q and simplify.

1. $f(x) = \frac{2x - 1}{x + 1}$

2. $g(x) = 2 - \frac{3}{x + 1}$

3. $h(x) = \frac{2x^2 - 1}{x^2 - 1} - \frac{3x - 2}{x^2 - 1}$

4. $r(x) = \frac{2x^2 - 1}{x^2 - 1} \div \frac{3x - 2}{x^2 - 1}$

Solution.

1. To find the domain of f , we proceed as we did in Section 1.4: we find the zeros of the denominator and exclude them from the domain. Setting $x + 1 = 0$ results in $x = -1$. Hence,

our domain is $(-\infty, -1) \cup (-1, \infty)$. The expression $f(x)$ is already in the form requested and when we check for common factors among the numerator and denominator we find none, so we are done.

2. Proceeding as before, we determine the domain of g by solving $x + 1 = 0$. As before, we find the domain of g is $(-\infty, -1) \cup (-1, \infty)$. To write $g(x)$ in the form requested, we need to get a common denominator

$$\begin{aligned} g(x) &= 2 - \frac{3}{x+1} = \frac{2}{1} - \frac{3}{x+1} = \frac{(2)(x+1)}{(1)(x+1)} - \frac{3}{x+1} \\ &= \frac{(2x+2) - 3}{x+1} = \frac{2x-1}{x+1} \end{aligned}$$

This formula is now completely simplified.

3. The denominators in the formula for $h(x)$ are both $x^2 - 1$ whose zeros are $x = \pm 1$. As a result, the domain of h is $(-\infty, -1) \cup (-1, 1) \cup (1, \infty)$. We now proceed to simplify $h(x)$. Since we have the same denominator in both terms, we subtract the numerators. We then factor the resulting numerator and denominator, and cancel out the common factor.

$$\begin{aligned} h(x) &= \frac{2x^2 - 1}{x^2 - 1} - \frac{3x - 2}{x^2 - 1} = \frac{(2x^2 - 1) - (3x - 2)}{x^2 - 1} \\ &= \frac{2x^2 - 1 - 3x + 2}{x^2 - 1} = \frac{2x^2 - 3x + 1}{x^2 - 1} \\ &= \frac{(2x - 1)(x - 1)}{(x + 1)(x - 1)} = \frac{(2x - 1)\cancel{(x - 1)}}{(x + 1)\cancel{(x - 1)}} \\ &= \frac{2x - 1}{x + 1} \end{aligned}$$

4. To find the domain of r , it may help to temporarily rewrite $r(x)$ as

$$r(x) = \frac{\frac{2x^2 - 1}{x^2 - 1}}{\frac{3x - 2}{x^2 - 1}}$$

We need to set all of the denominators equal to zero which means we need to solve not only $x^2 - 1 = 0$, but also $\frac{3x-2}{x^2-1} = 0$. We find $x = \pm 1$ for the former and $x = \frac{2}{3}$ for the latter. Our domain is $(-\infty, -1) \cup (-1, \frac{2}{3}) \cup (\frac{2}{3}, 1) \cup (1, \infty)$. We simplify $r(x)$ by rewriting the division as multiplication by the reciprocal and then by canceling the common factor

$$\begin{aligned}
 r(x) &= \frac{2x^2 - 1}{x^2 - 1} \div \frac{3x - 2}{x^2 - 1} = \frac{2x^2 - 1}{x^2 - 1} \cdot \frac{x^2 - 1}{3x - 2} = \frac{(2x^2 - 1)(x^2 - 1)}{(x^2 - 1)(3x - 2)} \\
 &= \frac{(2x^2 - 1)\cancel{(x^2 - 1)}}{\cancel{(x^2 - 1)}(3x - 2)} = \frac{2x^2 - 1}{3x - 2} \quad \square
 \end{aligned}$$

A few remarks about Example 4.1.1 are in order. Note that the expressions for $f(x)$, $g(x)$ and $h(x)$ work out to be the same. However, only two of these functions are actually equal. Recall that functions are ultimately sets of ordered pairs,¹ so for two functions to be equal, they need, among other things, to have the same domain. Since $f(x) = g(x)$ and f and g have the same domain, they are equal functions. Even though the formula $h(x)$ is the same as $f(x)$, the domain of h is different than the domain of f , and thus they are different functions.

We now turn our attention to the graphs of rational functions. Consider the function $f(x) = \frac{2x-1}{x+1}$ from Example 4.1.1. Using a graphing calculator, we obtain

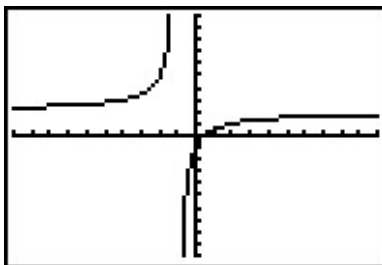

Two behaviors of the graph are worthy of further discussion. First, note that the graph appears to ‘break’ at $x = -1$. We know from our last example that $x = -1$ is not in the domain of f which means $f(-1)$ is undefined. When we make a table of values to study the behavior of f near $x = -1$ we see that we can get ‘near’ $x = -1$ from two directions. We can choose values a little less than -1 , for example $x = -1.1$, $x = -1.01$, $x = -1.001$, and so on. These values are said to ‘approach -1 from the left.’ Similarly, the values $x = -0.9$, $x = -0.99$, $x = -0.999$, etc., are said to ‘approach -1 from the right.’ If we make two tables, we find that the numerical results confirm what we see graphically.

x	$f(x)$	$(x, f(x))$
-1.1	32	$(-1.1, 32)$
-1.01	302	$(-1.01, 302)$
-1.001	3002	$(-1.001, 3002)$
-1.0001	30002	$(-1.0001, 30002)$

x	$f(x)$	$(x, f(x))$
-0.9	-28	$(-0.9, -28)$
-0.99	-298	$(-0.99, -298)$
-0.999	-2998	$(-0.999, -2998)$
-0.9999	-29998	$(-0.9999, -29998)$

As the x values approach -1 from the left, the function values become larger and larger positive numbers.² We express this symbolically by stating as $x \rightarrow -1^-$, $f(x) \rightarrow \infty$. Similarly, using analogous notation, we conclude from the table that as $x \rightarrow -1^+$, $f(x) \rightarrow -\infty$. For this type of

¹You should review Sections 1.2 and 1.3 if this statement caught you off guard.

²We would need Calculus to confirm this analytically.

unbounded behavior, we say the graph of $y = f(x)$ has a **vertical asymptote** of $x = -1$. Roughly speaking, this means that near $x = -1$, the graph looks very much like the vertical line $x = -1$.

The other feature worthy of note about the graph of $y = f(x)$ is that it seems to ‘level off’ on the left and right hand sides of the screen. This is a statement about the end behavior of the function. As we discussed in Section 3.1, the end behavior of a function is its behavior as x attains larger³ and larger negative values without bound, $x \rightarrow -\infty$, and as x becomes large without bound, $x \rightarrow \infty$. Making tables of values, we find

x	$f(x)$	$(x, f(x))$
-10	≈ 2.3333	$\approx (-10, 2.3333)$
-100	≈ 2.0303	$\approx (-100, 2.0303)$
-1000	≈ 2.0030	$\approx (-1000, 2.0030)$
-10000	≈ 2.0003	$\approx (-10000, 2.0003)$

x	$f(x)$	$(x, f(x))$
10	≈ 1.7273	$\approx (10, 1.7273)$
100	≈ 1.9703	$\approx (100, 1.9703)$
1000	≈ 1.9970	$\approx (1000, 1.9970)$
10000	≈ 1.9997	$\approx (10000, 1.9997)$

From the tables, we see that as $x \rightarrow -\infty$, $f(x) \rightarrow 2^+$ and as $x \rightarrow \infty$, $f(x) \rightarrow 2^-$. Here the ‘+’ means ‘from above’ and the ‘-’ means ‘from below’. In this case, we say the graph of $y = f(x)$ has a **horizontal asymptote** of $y = 2$. This means that the end behavior of f resembles the horizontal line $y = 2$, which explains the ‘leveling off’ behavior we see in the calculator’s graph. We formalize the concepts of vertical and horizontal asymptotes in the following definitions.

Definition 4.2. The line $x = c$ is called a **vertical asymptote** of the graph of a function $y = f(x)$ if as $x \rightarrow c^-$ or as $x \rightarrow c^+$, either $f(x) \rightarrow \infty$ or $f(x) \rightarrow -\infty$.

Definition 4.3. The line $y = c$ is called a **horizontal asymptote** of the graph of a function $y = f(x)$ if as $x \rightarrow -\infty$ or as $x \rightarrow \infty$, $f(x) \rightarrow c$.

Note that in Definition 4.3, we write $f(x) \rightarrow c$ (not $f(x) \rightarrow c^+$ or $f(x) \rightarrow c^-$) because we are unconcerned from which direction the values $f(x)$ approach the value c , just as long as they do so.⁴ In our discussion following Example 4.1.1, we determined that, despite the fact that the formula for $h(x)$ reduced to the same formula as $f(x)$, the functions f and h are different, since $x = 1$ is in the domain of f , but $x = 1$ is not in the domain of h . If we graph $h(x) = \frac{2x^2-1}{x^2-1} - \frac{3x-2}{x^2-1}$ using a graphing calculator, we are surprised to find that the graph looks identical to the graph of $y = f(x)$. There is a vertical asymptote at $x = -1$, but near $x = 1$, everything seem fine. Tables of values provide numerical evidence which supports the graphical observation.

³Here, the word ‘larger’ means larger in absolute value.

⁴As we shall see in the next section, the graphs of rational functions may, in fact, *cross* their horizontal asymptotes. If this happens, however, it does so only a *finite* number of times, and so for each choice of $x \rightarrow -\infty$ and $x \rightarrow \infty$, $f(x)$ will approach c from either below (in the case $f(x) \rightarrow c^-$) or above (in the case $f(x) \rightarrow c^+$.) We leave $f(x) \rightarrow c$ generic in our definition, however, to allow this concept to apply to less tame specimens in the Precalculus zoo, such as Exercise 50 in Section 8.5.

x	$h(x)$	$(x, h(x))$
0.9	≈ 0.4210	$\approx (0.9, 0.4210)$
0.99	≈ 0.4925	$\approx (0.99, 0.4925)$
0.999	≈ 0.4992	$\approx (0.999, 0.4992)$
0.9999	≈ 0.4999	$\approx (0.9999, 0.4999)$

x	$h(x)$	$(x, h(x))$
1.1	≈ 0.5714	$\approx (1.1, 0.5714)$
1.01	≈ 0.5075	$\approx (1.01, 0.5075)$
1.001	≈ 0.5007	$\approx (1.001, 0.5007)$
1.0001	≈ 0.5001	$\approx (1.0001, 0.5001)$

We see that as $x \rightarrow 1^-$, $h(x) \rightarrow 0.5^-$ and as $x \rightarrow 1^+$, $h(x) \rightarrow 0.5^+$. In other words, the points on the graph of $y = h(x)$ are approaching $(1, 0.5)$, but since $x = 1$ is not in the domain of h , it would be inaccurate to fill in a point at $(1, 0.5)$. As we've done in past sections when something like this occurs,⁵ we put an open circle (also called a **hole** in this case⁶) at $(1, 0.5)$. Below is a detailed graph of $y = h(x)$, with the vertical and horizontal asymptotes as dashed lines.

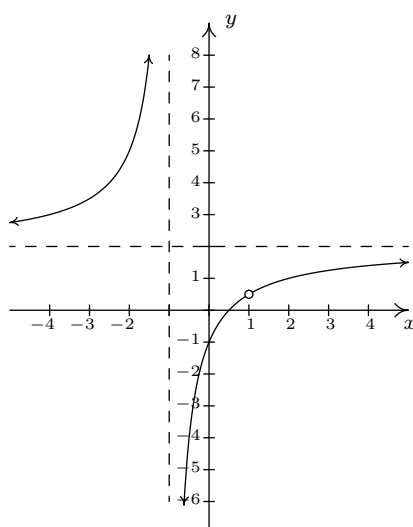

Neither $x = -1$ nor $x = 1$ are in the domain of h , yet the behavior of the graph of $y = h(x)$ is drastically different near these x -values. The reason for this lies in the second to last step when we simplified the formula for $h(x)$ in Example 4.1.1, where we had $h(x) = \frac{(2x-1)(x-1)}{(x+1)(x-1)}$. The reason $x = -1$ is not in the domain of h is because the factor $(x + 1)$ appears in the denominator of $h(x)$; similarly, $x = 1$ is not in the domain of h because of the factor $(x - 1)$ in the denominator of $h(x)$. The major difference between these two factors is that $(x - 1)$ cancels with a factor in the numerator whereas $(x + 1)$ does not. Loosely speaking, the trouble caused by $(x - 1)$ in the denominator is canceled away while the factor $(x + 1)$ remains to cause mischief. This is why the graph of $y = h(x)$ has a vertical asymptote at $x = -1$ but only a hole at $x = 1$. These observations are generalized and summarized in the theorem below, whose proof is found in Calculus.

⁵For instance, graphing piecewise defined functions in Section 1.6.

⁶In Calculus, we will see how these ‘holes’ can be ‘plugged’ when embarking on a more advanced study of continuity.

Theorem 4.1. Location of Vertical Asymptotes and Holes:^a Suppose r is a rational function which can be written as $r(x) = \frac{p(x)}{q(x)}$ where p and q have no common zeros.^b Let c be a real number which is not in the domain of r .

- If $q(c) \neq 0$, then the graph of $y = r(x)$ has a hole at $\left(c, \frac{p(c)}{q(c)}\right)$.
- If $q(c) = 0$, then the line $x = c$ is a vertical asymptote of the graph of $y = r(x)$.

^aOr, ‘How to tell your asymptote from a hole in the graph.’

^bIn other words, $r(x)$ is in lowest terms.

In English, Theorem 4.1 says that if $x = c$ is not in the domain of r but, when we simplify $r(x)$, it no longer makes the denominator 0, then we have a hole at $x = c$. Otherwise, the line $x = c$ is a vertical asymptote of the graph of $y = r(x)$.

Example 4.1.2. Find the vertical asymptotes of, and/or holes in, the graphs of the following rational functions. Verify your answers using a graphing calculator, and describe the behavior of the graph near them using proper notation.

$$1. f(x) = \frac{2x}{x^2 - 3}$$

$$2. g(x) = \frac{x^2 - x - 6}{x^2 - 9}$$

$$3. h(x) = \frac{x^2 - x - 6}{x^2 + 9}$$

$$4. r(x) = \frac{x^2 - x - 6}{x^2 + 4x + 4}$$

Solution.

1. To use Theorem 4.1, we first find all of the real numbers which aren't in the domain of f . To do so, we solve $x^2 - 3 = 0$ and get $x = \pm\sqrt{3}$. Since the expression $f(x)$ is in lowest terms, there is no cancellation possible, and we conclude that the lines $x = -\sqrt{3}$ and $x = \sqrt{3}$ are vertical asymptotes to the graph of $y = f(x)$. The calculator verifies this claim, and from the graph, we see that as $x \rightarrow -\sqrt{3}^-$, $f(x) \rightarrow -\infty$, as $x \rightarrow -\sqrt{3}^+$, $f(x) \rightarrow \infty$, as $x \rightarrow \sqrt{3}^-$, $f(x) \rightarrow -\infty$, and finally as $x \rightarrow \sqrt{3}^+$, $f(x) \rightarrow \infty$.
2. Solving $x^2 - 9 = 0$ gives $x = \pm 3$. In lowest terms $g(x) = \frac{x^2 - x - 6}{x^2 - 9} = \frac{(x-3)(x+2)}{(x-3)(x+3)} = \frac{x+2}{x+3}$. Since $x = -3$ continues to make trouble in the denominator, we know the line $x = -3$ is a vertical asymptote of the graph of $y = g(x)$. Since $x = 3$ no longer produces a 0 in the denominator, we have a hole at $x = 3$. To find the y -coordinate of the hole, we substitute $x = 3$ into $\frac{x+2}{x+3}$ and find the hole is at $\left(3, \frac{5}{6}\right)$. When we graph $y = g(x)$ using a calculator, we clearly see the vertical asymptote at $x = -3$, but everything seems calm near $x = 3$. Hence, as $x \rightarrow -3^-$, $g(x) \rightarrow \infty$, as $x \rightarrow -3^+$, $g(x) \rightarrow -\infty$, as $x \rightarrow 3^-$, $g(x) \rightarrow \frac{5}{6}^-$, and as $x \rightarrow 3^+$, $g(x) \rightarrow \frac{5}{6}^+$.

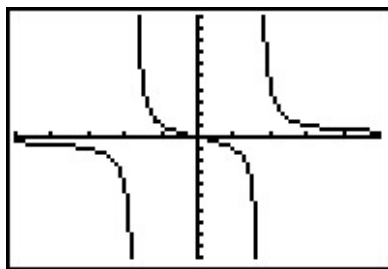
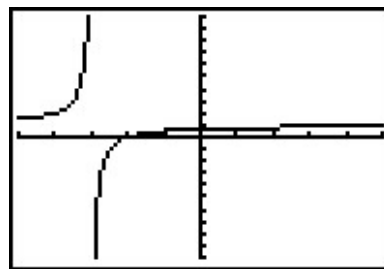
The graph of $y = f(x)$ The graph of $y = g(x)$

- The domain of h is all real numbers, since $x^2 + 9 = 0$ has no real solutions. Accordingly, the graph of $y = h(x)$ is devoid of both vertical asymptotes and holes.
- Setting $x^2 + 4x + 4 = 0$ gives us $x = -2$ as the only real number of concern. Simplifying, we see $r(x) = \frac{x^2 - x - 6}{x^2 + 4x + 4} = \frac{(x-3)(x+2)}{(x+2)^2} = \frac{x-3}{x+2}$. Since $x = -2$ continues to produce a 0 in the denominator of the reduced function, we know $x = -2$ is a vertical asymptote to the graph. The calculator bears this out, and, moreover, we see that as $x \rightarrow -2^-$, $r(x) \rightarrow \infty$ and as $x \rightarrow -2^+$, $r(x) \rightarrow -\infty$.

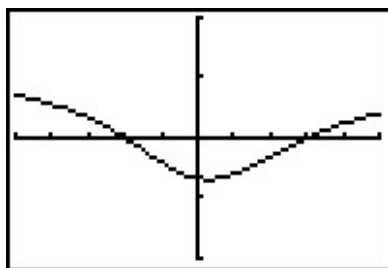
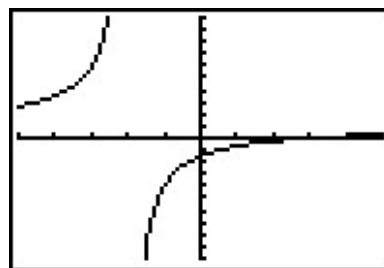
The graph of $y = h(x)$ The graph of $y = r(x)$

□

Our next example gives us a physical interpretation of a vertical asymptote. This type of model arises from a family of equations cheerily named ‘doomsday’ equations.⁷

Example 4.1.3. A mathematical model for the population P , in thousands, of a certain species of bacteria, t days after it is introduced to an environment is given by $P(t) = \frac{100}{(5-t)^2}$, $0 \leq t < 5$.

- Find and interpret $P(0)$.
- When will the population reach 100,000?
- Determine the behavior of P as $t \rightarrow 5^-$. Interpret this result graphically and within the context of the problem.

⁷These functions arise in Differential Equations. The unfortunate name will make sense shortly.

Solution.

1. Substituting $t = 0$ gives $P(0) = \frac{100}{(5-0)^2} = 4$, which means 4000 bacteria are initially introduced into the environment.
2. To find when the population reaches 100,000, we first need to remember that $P(t)$ is measured in *thousands*. In other words, 100,000 bacteria corresponds to $P(t) = 100$. Substituting for $P(t)$ gives the equation $\frac{100}{(5-t)^2} = 100$. Clearing denominators and dividing by 100 gives $(5-t)^2 = 1$, which, after extracting square roots, produces $t = 4$ or $t = 6$. Of these two solutions, only $t = 4$ is in our domain, so this is the solution we keep. Hence, it takes 4 days for the population of bacteria to reach 100,000.
3. To determine the behavior of P as $t \rightarrow 5^-$, we can make a table

t	$P(t)$
4.9	10000
4.99	1000000
4.999	100000000
4.9999	10000000000

In other words, as $t \rightarrow 5^-$, $P(t) \rightarrow \infty$. Graphically, the line $t = 5$ is a vertical asymptote of the graph of $y = P(t)$. Physically, this means that the population of bacteria is increasing without bound as we near 5 days, which cannot actually happen. For this reason, $t = 5$ is called the ‘doomsday’ for this population. There is no way any environment can support infinitely many bacteria, so shortly before $t = 5$ the environment would collapse. \square

Now that we have thoroughly investigated vertical asymptotes, we can turn our attention to horizontal asymptotes. The next theorem tells us when to expect horizontal asymptotes.

Theorem 4.2. Location of Horizontal Asymptotes: Suppose r is a rational function and $r(x) = \frac{p(x)}{q(x)}$, where p and q are polynomial functions with leading coefficients a and b , respectively.

- If the degree of $p(x)$ is the same as the degree of $q(x)$, then $y = \frac{a}{b}$ is the^a horizontal asymptote of the graph of $y = r(x)$.
- If the degree of $p(x)$ is less than the degree of $q(x)$, then $y = 0$ is the horizontal asymptote of the graph of $y = r(x)$.
- If the degree of $p(x)$ is greater than the degree of $q(x)$, then the graph of $y = r(x)$ has no horizontal asymptotes.

^aThe use of the definite article will be justified momentarily.

Like Theorem 4.1, Theorem 4.2 is proved using Calculus. Nevertheless, we can understand the idea behind it using our example $f(x) = \frac{2x-1}{x+1}$. If we interpret $f(x)$ as a division problem, $(2x-1) \div (x+1)$,

we find that the quotient is 2 with a remainder of -3 . Using what we know about polynomial division, specifically Theorem 3.4, we get $2x - 1 = 2(x + 1) - 3$. Dividing both sides by $(x + 1)$ gives $\frac{2x-1}{x+1} = 2 - \frac{3}{x+1}$. (You may remember this as the formula for $g(x)$ in Example 4.1.1.) As x becomes unbounded in either direction, the quantity $\frac{3}{x+1}$ gets closer and closer to 0 so that the values of $f(x)$ become closer and closer⁸ to 2. In symbols, as $x \rightarrow \pm\infty$, $f(x) \rightarrow 2$, and we have the result.⁹ Notice that the graph gets close to the same y value as $x \rightarrow -\infty$ or $x \rightarrow \infty$. This means that the graph can have only one horizontal asymptote if it is going to have one at all. Thus we were justified in using ‘the’ in the previous theorem.

Alternatively, we can use what we know about end behavior of polynomials to help us understand this theorem. From Theorem 3.2, we know the end behavior of a polynomial is determined by its leading term. Applying this to the numerator and denominator of $f(x)$, we get that as $x \rightarrow \pm\infty$, $f(x) = \frac{2x-1}{x+1} \approx \frac{2x}{x} = 2$. This last approach is useful in Calculus, and, indeed, is made rigorous there. (Keep this in mind for the remainder of this paragraph.) Applying this reasoning to the general case, suppose $r(x) = \frac{p(x)}{q(x)}$ where a is the leading coefficient of $p(x)$ and b is the leading coefficient of $q(x)$. As $x \rightarrow \pm\infty$, $r(x) \approx \frac{ax^n}{bx^m}$, where n and m are the degrees of $p(x)$ and $q(x)$, respectively. If the degree of $p(x)$ and the degree of $q(x)$ are the same, then $n = m$ so that $r(x) \approx \frac{a}{b}$, which means $y = \frac{a}{b}$ is the horizontal asymptote in this case. If the degree of $p(x)$ is less than the degree of $q(x)$, then $n < m$, so $m - n$ is a positive number, and hence, $r(x) \approx \frac{a}{bx^{m-n}} \rightarrow 0$ as $x \rightarrow \pm\infty$. If the degree of $p(x)$ is greater than the degree of $q(x)$, then $n > m$, and hence $n - m$ is a positive number and $r(x) \approx \frac{ax^{n-m}}{b}$, which becomes unbounded as $x \rightarrow \pm\infty$. As we said before, if a rational function has a horizontal asymptote, then it will have only one. (This is not true for other types of functions we shall see in later chapters.)

Example 4.1.4. List the horizontal asymptotes, if any, of the graphs of the following functions. Verify your answers using a graphing calculator, and describe the behavior of the graph near them using proper notation.

$$1. f(x) = \frac{5x}{x^2 + 1}$$

$$2. g(x) = \frac{x^2 - 4}{x + 1}$$

$$3. h(x) = \frac{6x^3 - 3x + 1}{5 - 2x^3}$$

Solution.

1. The numerator of $f(x)$ is $5x$, which has degree 1. The denominator of $f(x)$ is $x^2 + 1$, which has degree 2. Applying Theorem 4.2, $y = 0$ is the horizontal asymptote. Sure enough, we see from the graph that as $x \rightarrow -\infty$, $f(x) \rightarrow 0^-$ and as $x \rightarrow \infty$, $f(x) \rightarrow 0^+$.
2. The numerator of $g(x)$, $x^2 - 4$, has degree 2, but the degree of the denominator, $x + 1$, has degree 1. By Theorem 4.2, there is no horizontal asymptote. From the graph, we see that the graph of $y = g(x)$ doesn't appear to level off to a constant value, so there is no horizontal asymptote.¹⁰

⁸As seen in the tables immediately preceding Definition 4.2.

⁹More specifically, as $x \rightarrow -\infty$, $f(x) \rightarrow 2^+$, and as $x \rightarrow \infty$, $f(x) \rightarrow 2^-$.

¹⁰Sit tight! We'll revisit this function and its end behavior shortly.

3. The degrees of the numerator and denominator of $h(x)$ are both three, so Theorem 4.2 tells us $y = \frac{6}{-2} = -3$ is the horizontal asymptote. We see from the calculator's graph that as $x \rightarrow -\infty$, $h(x) \rightarrow -3^+$, and as $x \rightarrow \infty$, $h(x) \rightarrow -3^-$.

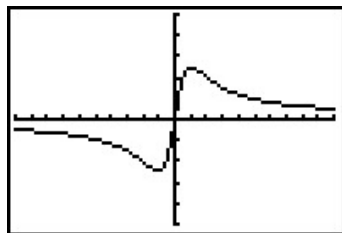
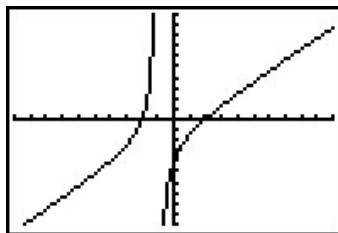
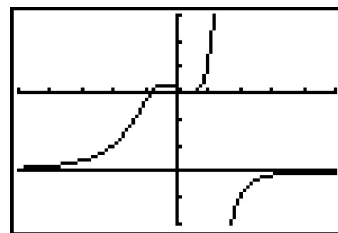
The graph of $y = f(x)$ The graph of $y = g(x)$ The graph of $y = h(x)$

□

Our next example of the section gives us a real-world application of a horizontal asymptote.¹¹

Example 4.1.5. The number of students N at local college who have had the flu t months after the semester begins can be modeled by the formula $N(t) = 500 - \frac{450}{1+3t}$ for $t \geq 0$.

1. Find and interpret $N(0)$.
2. How long will it take until 300 students will have had the flu?
3. Determine the behavior of N as $t \rightarrow \infty$. Interpret this result graphically and within the context of the problem.

Solution.

1. $N(0) = 500 - \frac{450}{1+3(0)} = 50$. This means that at the beginning of the semester, 50 students have had the flu.
2. We set $N(t) = 300$ to get $500 - \frac{450}{1+3t} = 300$ and solve. Isolating the fraction gives $\frac{450}{1+3t} = 200$. Clearing denominators gives $450 = 200(1+3t)$. Finally, we get $t = \frac{5}{12}$. This means it will take $\frac{5}{12}$ months, or about 13 days, for 300 students to have had the flu.
3. To determine the behavior of N as $t \rightarrow \infty$, we can use a table.

t	$N(t)$
10	≈ 485.48
100	≈ 498.50
1000	≈ 499.85
10000	≈ 499.98

The table suggests that as $t \rightarrow \infty$, $N(t) \rightarrow 500$. (More specifically, 500^- .) This means as time goes by, only a total of 500 students will have ever had the flu. □

¹¹Though the population below is more accurately modeled with the functions in Chapter 6, we approximate it (using Calculus, of course!) using a rational function.

We close this section with a discussion of the *third* (and final!) kind of asymptote which can be associated with the graphs of rational functions. Let us return to the function $g(x) = \frac{x^2-4}{x+1}$ in Example 4.1.4. Performing long division,¹² we get $g(x) = \frac{x^2-4}{x+1} = x - 1 - \frac{3}{x+1}$. Since the term $\frac{3}{x+1} \rightarrow 0$ as $x \rightarrow \pm\infty$, it stands to reason that as x becomes unbounded, the function values $g(x) = x - 1 - \frac{3}{x+1} \approx x - 1$. Geometrically, this means that the graph of $y = g(x)$ should resemble the line $y = x - 1$ as $x \rightarrow \pm\infty$. We see this play out both numerically and graphically below.

x	$g(x)$	$x - 1$
-10	≈ -10.6667	-11
-100	≈ -100.9697	-101
-1000	≈ -1000.9970	-1001
-10000	≈ -10000.9997	-10001

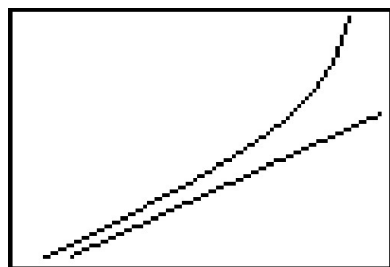

$y = g(x)$ and $y = x - 1$
as $x \rightarrow -\infty$

x	$g(x)$	$x - 1$
10	≈ 8.7273	9
100	≈ 98.9703	99
1000	≈ 998.9970	999
10000	≈ 9998.9997	9999

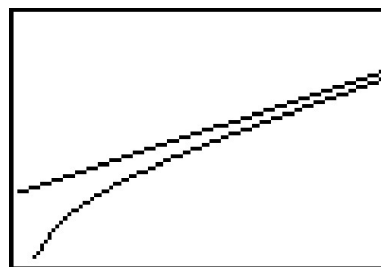

$y = g(x)$ and $y = x - 1$
as $x \rightarrow \infty$

The way we symbolize the relationship between the end behavior of $y = g(x)$ with that of the line $y = x - 1$ is to write ‘as $x \rightarrow \pm\infty$, $g(x) \rightarrow x - 1$.’ In this case, we say the line $y = x - 1$ is a **slant asymptote**¹³ to the graph of $y = g(x)$. Informally, the graph of a rational function has a slant asymptote if, as $x \rightarrow \infty$ or as $x \rightarrow -\infty$, the graph resembles a non-horizontal, or ‘slanted’ line. Formally, we define a slant asymptote as follows.

Definition 4.4. The line $y = mx + b$ where $m \neq 0$ is called a **slant asymptote** of the graph of a function $y = f(x)$ if as $x \rightarrow -\infty$ or as $x \rightarrow \infty$, $f(x) \rightarrow mx + b$.

A few remarks are in order. First, note that the stipulation $m \neq 0$ in Definition 4.4 is what makes the ‘slant’ asymptote ‘slanted’ as opposed to the case when $m = 0$ in which case we’d have a horizontal asymptote. Secondly, while we have motivated what we mean intuitively by the notation ‘ $f(x) \rightarrow mx + b$,’ like so many ideas in this section, the formal definition requires Calculus. Another way to express this sentiment, however, is to rephrase ‘ $f(x) \rightarrow mx + b$ ’ as ‘ $f(x) - (mx + b) \rightarrow 0$.’ In other words, the graph of $y = f(x)$ has the *slant* asymptote $y = mx + b$ if and only if the graph of $y = f(x) - (mx + b)$ has a *horizontal* asymptote $y = 0$.

¹²See the remarks following Theorem 4.2.

¹³Also called an ‘oblique’ asymptote in some, ostensibly higher class (and more expensive), texts.

Our next task is to determine the conditions under which the graph of a rational function has a slant asymptote, and if it does, how to find it. In the case of $g(x) = \frac{x^2-4}{x+1}$, the degree of the numerator $x^2 - 4$ is 2, which is *exactly one more* than the degree of its denominator $x + 1$ which is 1. This results in a *linear* quotient polynomial, and it is this quotient polynomial which is the slant asymptote. Generalizing this situation gives us the following theorem.¹⁴

Theorem 4.3. Determination of Slant Asymptotes: Suppose r is a rational function and $r(x) = \frac{p(x)}{q(x)}$, where the degree of p is *exactly one more* than the degree of q . Then the graph of $y = r(x)$ has the slant asymptote $y = L(x)$ where $L(x)$ is the quotient obtained by dividing $p(x)$ by $q(x)$.

In the same way that Theorem 4.2 gives us an easy way to see if the graph of a rational function $r(x) = \frac{p(x)}{q(x)}$ has a horizontal asymptote by comparing the degrees of the numerator and denominator, Theorem 4.3 gives us an easy way to check for slant asymptotes. Unlike Theorem 4.2, which gives us a quick way to *find* the horizontal asymptotes (if any exist), Theorem 4.3 gives us no such ‘short-cut’. If a slant asymptote exists, we have no recourse but to use long division to find it.¹⁵

Example 4.1.6. Find the slant asymptotes of the graphs of the following functions if they exist. Verify your answers using a graphing calculator and describe the behavior of the graph near them using proper notation.

$$1. f(x) = \frac{x^2 - 4x + 2}{1 - x} \qquad 2. g(x) = \frac{x^2 - 4}{x - 2} \qquad 3. h(x) = \frac{x^3 + 1}{x^2 - 4}$$

Solution.

- The degree of the numerator is 2 and the degree of the denominator is 1, so Theorem 4.3 guarantees us a slant asymptote. To find it, we divide $1 - x = -x + 1$ into $x^2 - 4x + 2$ and get a quotient of $-x + 3$, so our slant asymptote is $y = -x + 3$. We confirm this graphically, and we see that as $x \rightarrow -\infty$, the graph of $y = f(x)$ approaches the asymptote from below, and as $x \rightarrow \infty$, the graph of $y = f(x)$ approaches the asymptote from above.¹⁶
- As with the previous example, the degree of the numerator $g(x) = \frac{x^2-4}{x-2}$ is 2 and the degree of the denominator is 1, so Theorem 4.3 applies. In this case,

$$g(x) = \frac{x^2 - 4}{x - 2} = \frac{(x + 2)(x - 2)}{(x - 2)} = \frac{(x + 2)\cancel{(x - 2)}}{\cancel{(x - 2)}^1} = x + 2, \quad x \neq 2$$

¹⁴Once again, this theorem is brought to you courtesy of Theorem 3.4 and Calculus.

¹⁵That’s OK, though. In the next section, we’ll use long division to analyze end behavior and it’s worth the effort!

¹⁶Note that we are purposefully avoiding notation like ‘as $x \rightarrow \infty$, $f(x) \rightarrow (-x + 3)^+$ ’. While it is possible to define these notions formally with Calculus, it is not standard to do so. Besides, with the introduction of the symbol ‘?’ in the next section, the authors feel we are in enough trouble already.

so we have that the slant asymptote $y = x + 2$ is identical to the graph of $y = g(x)$ except at $x = 2$ (where the latter has a ‘hole’ at $(2, 4)$.) The calculator supports this claim.¹⁷

3. For $h(x) = \frac{x^3+1}{x^2-4}$, the degree of the numerator is 3 and the degree of the denominator is 2 so again, we are guaranteed the existence of a slant asymptote. The long division $(x^3 + 1) \div (x^2 - 4)$ gives a quotient of just x , so our slant asymptote is the line $y = x$. The calculator confirms this, and we find that as $x \rightarrow -\infty$, the graph of $y = h(x)$ approaches the asymptote from below, and as $x \rightarrow \infty$, the graph of $y = h(x)$ approaches the asymptote from above.

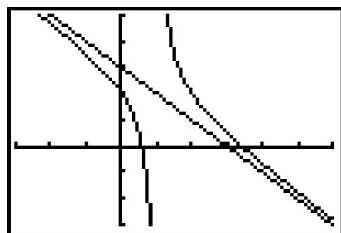
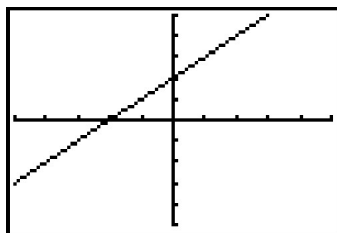
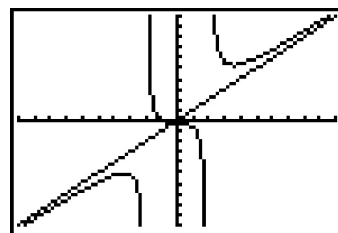
The graph of $y = f(x)$ The graph of $y = g(x)$ The graph of $y = h(x)$

□

The reader may be a bit disappointed with the authors at this point owing to the fact that in Examples 4.1.2, 4.1.4, and 4.1.6, we used the *calculator* to determine function behavior near asymptotes. We rectify that in the next section where we, in excruciating detail, demonstrate the usefulness of ‘number sense’ to reveal this behavior analytically.

¹⁷While the word ‘asymptote’ has the connotation of ‘approaching but not equaling,’ Definitions 4.3 and 4.4 invite the same kind of pathologies we saw with Definition 1.11 in Section 1.6.

4.1.1 EXERCISES

In Exercises 1 - 18, for the given rational function f :

- Find the domain of f .
- Identify any vertical asymptotes of the graph of $y = f(x)$.
- Identify any holes in the graph.
- Find the horizontal asymptote, if it exists.
- Find the slant asymptote, if it exists.
- Graph the function using a graphing utility and describe the behavior near the asymptotes.

1. $f(x) = \frac{x}{3x - 6}$

2. $f(x) = \frac{3 + 7x}{5 - 2x}$

3. $f(x) = \frac{x}{x^2 + x - 12}$

4. $f(x) = \frac{x}{x^2 + 1}$

5. $f(x) = \frac{x + 7}{(x + 3)^2}$

6. $f(x) = \frac{x^3 + 1}{x^2 - 1}$

7. $f(x) = \frac{4x}{x^2 + 4}$

8. $f(x) = \frac{4x}{x^2 - 4}$

9. $f(x) = \frac{x^2 - x - 12}{x^2 + x - 6}$

10. $f(x) = \frac{3x^2 - 5x - 2}{x^2 - 9}$

11. $f(x) = \frac{x^3 + 2x^2 + x}{x^2 - x - 2}$

12. $f(x) = \frac{x^3 - 3x + 1}{x^2 + 1}$

13. $f(x) = \frac{2x^2 + 5x - 3}{3x + 2}$

14. $f(x) = \frac{-x^3 + 4x}{x^2 - 9}$

15. $f(x) = \frac{-5x^4 - 3x^3 + x^2 - 10}{x^3 - 3x^2 + 3x - 1}$

16. $f(x) = \frac{x^3}{1 - x}$

17. $f(x) = \frac{18 - 2x^2}{x^2 - 9}$

18. $f(x) = \frac{x^3 - 4x^2 - 4x - 5}{x^2 + x + 1}$

19. The cost C in dollars to remove $p\%$ of the invasive species of Ippizuti fish from Sasquatch Pond is given by

$$C(p) = \frac{1770p}{100 - p}, \quad 0 \leq p < 100$$

- (a) Find and interpret $C(25)$ and $C(95)$.
 - (b) What does the vertical asymptote at $x = 100$ mean within the context of the problem?
 - (c) What percentage of the Ippizuti fish can you remove for \$40000?
20. In Exercise 71 in Section 1.4, the population of Sasquatch in Portage County was modeled by the function

$$P(t) = \frac{150t}{t + 15},$$

where $t = 0$ represents the year 1803. Find the horizontal asymptote of the graph of $y = P(t)$ and explain what it means.

21. Recall from Example 1.5.3 that the cost C (in dollars) to make x dOpi media players is $C(x) = 100x + 2000$, $x \geq 0$.
- Find a formula for the average cost $\bar{C}(x)$. Recall: $\bar{C}(x) = \frac{C(x)}{x}$.
 - Find and interpret $\bar{C}(1)$ and $\bar{C}(100)$.
 - How many dOpis need to be produced so that the average cost per dOpi is \$200?
 - Interpret the behavior of $\bar{C}(x)$ as $x \rightarrow 0^+$. (HINT: You may want to find the fixed cost $C(0)$ to help in your interpretation.)
 - Interpret the behavior of $\bar{C}(x)$ as $x \rightarrow \infty$. (HINT: You may want to find the variable cost (defined in Example 2.1.5 in Section 2.1) to help in your interpretation.)
22. In Exercise 35 in Section 3.1, we fit a few polynomial models to the following electric circuit data. (The circuit was built with a variable resistor. For each of the following resistance values (measured in kilo-ohms, $k\Omega$), the corresponding power to the load (measured in milliwatts, mW) is given in the table below.)¹⁸

Resistance: ($k\Omega$)	1.012	2.199	3.275	4.676	6.805	9.975
Power: (mW)	1.063	1.496	1.610	1.613	1.505	1.314

Using some fundamental laws of circuit analysis mixed with a healthy dose of algebra, we can derive the actual formula relating power to resistance. For this circuit, it is $P(x) = \frac{25x}{(x+3.9)^2}$, where x is the resistance value, $x \geq 0$.

- Graph the data along with the function $y = P(x)$ on your calculator.
 - Use your calculator to approximate the maximum power that can be delivered to the load. What is the corresponding resistance value?
 - Find and interpret the end behavior of $P(x)$ as $x \rightarrow \infty$.
23. In his now famous 1919 dissertation The Learning Curve Equation, Louis Leon Thurstone presents a rational function which models the number of words a person can type in four minutes as a function of the number of pages of practice one has completed. (This paper, which is now in the public domain and can be found [here](#), is from a bygone era when students at business schools took typing classes on manual typewriters.) Using his original notation and original language, we have $Y = \frac{L(X+P)}{(X+P)+R}$ where L is the predicted practice limit in terms of speed units, X is pages written, Y is writing speed in terms of words in four minutes, P is equivalent previous practice in terms of pages and R is the rate of learning. In Figure 5 of the paper, he graphs a scatter plot and the curve $Y = \frac{216(X+19)}{X+148}$. Discuss this equation with your classmates. How would you update the notation? Explain what the horizontal asymptote of the graph means. You should take some time to look at the original paper. Skip over the computations you don't understand yet and try to get a sense of the time and place in which the study was conducted.

¹⁸The authors wish to thank Don Anthan and Ken White of Lakeland Community College for devising this problem and generating the accompanying data set.

4.1.2 ANSWERS

1. $f(x) = \frac{x}{3x-6}$

Domain: $(-\infty, 2) \cup (2, \infty)$ Vertical asymptote: $x = 2$ As $x \rightarrow 2^-$, $f(x) \rightarrow -\infty$ As $x \rightarrow 2^+$, $f(x) \rightarrow \infty$

No holes in the graph

Horizontal asymptote: $y = \frac{1}{3}$ As $x \rightarrow -\infty$, $f(x) \rightarrow \frac{1}{3}^-$ As $x \rightarrow \infty$, $f(x) \rightarrow \frac{1}{3}^+$

2. $f(x) = \frac{3+7x}{5-2x}$

Domain: $(-\infty, \frac{5}{2}) \cup (\frac{5}{2}, \infty)$ Vertical asymptote: $x = \frac{5}{2}$ As $x \rightarrow \frac{5}{2}^-$, $f(x) \rightarrow \infty$ As $x \rightarrow \frac{5}{2}^+$, $f(x) \rightarrow -\infty$

No holes in the graph

Horizontal asymptote: $y = -\frac{7}{2}$ As $x \rightarrow -\infty$, $f(x) \rightarrow -\frac{7}{2}^+$ As $x \rightarrow \infty$, $f(x) \rightarrow -\frac{7}{2}^-$

3. $f(x) = \frac{x}{x^2+x-12} = \frac{x}{(x+4)(x-3)}$

Domain: $(-\infty, -4) \cup (-4, 3) \cup (3, \infty)$ Vertical asymptotes: $x = -4, x = 3$ As $x \rightarrow -4^-$, $f(x) \rightarrow -\infty$ As $x \rightarrow -4^+$, $f(x) \rightarrow \infty$ As $x \rightarrow 3^-$, $f(x) \rightarrow -\infty$ As $x \rightarrow 3^+$, $f(x) \rightarrow \infty$

No holes in the graph

Horizontal asymptote: $y = 0$ As $x \rightarrow -\infty$, $f(x) \rightarrow 0^-$ As $x \rightarrow \infty$, $f(x) \rightarrow 0^+$

4. $f(x) = \frac{x}{x^2+1}$

Domain: $(-\infty, \infty)$

No vertical asymptotes

No holes in the graph

Horizontal asymptote: $y = 0$ As $x \rightarrow -\infty$, $f(x) \rightarrow 0^-$ As $x \rightarrow \infty$, $f(x) \rightarrow 0^+$

5. $f(x) = \frac{x+7}{(x+3)^2}$

Domain: $(-\infty, -3) \cup (-3, \infty)$ Vertical asymptote: $x = -3$ As $x \rightarrow -3^-$, $f(x) \rightarrow \infty$ As $x \rightarrow -3^+$, $f(x) \rightarrow -\infty$

No holes in the graph

Horizontal asymptote: $y = 0$ ¹⁹As $x \rightarrow -\infty$, $f(x) \rightarrow 0^-$ As $x \rightarrow \infty$, $f(x) \rightarrow 0^+$

6. $f(x) = \frac{x^3+1}{x^2-1} = \frac{x^2-x+1}{x-1}$

Domain: $(-\infty, -1) \cup (-1, 1) \cup (1, \infty)$ Vertical asymptote: $x = 1$ As $x \rightarrow 1^-$, $f(x) \rightarrow -\infty$ As $x \rightarrow 1^+$, $f(x) \rightarrow \infty$ Hole at $(-1, -\frac{3}{2})$ Slant asymptote: $y = x$ As $x \rightarrow -\infty$, the graph is below $y = x$ As $x \rightarrow \infty$, the graph is above $y = x$ ¹⁹This is hard to see on the calculator, but trust me, the graph is below the x -axis to the left of $x = -7$.

7. $f(x) = \frac{4x}{x^2 + 4}$
 Domain: $(-\infty, \infty)$
 No vertical asymptotes
 No holes in the graph
 Horizontal asymptote: $y = 0$
 As $x \rightarrow -\infty, f(x) \rightarrow 0^-$
 As $x \rightarrow \infty, f(x) \rightarrow 0^+$
8. $f(x) = \frac{4x}{x^2 - 4} = \frac{4x}{(x + 2)(x - 2)}$
 Domain: $(-\infty, -2) \cup (-2, 2) \cup (2, \infty)$
 Vertical asymptotes: $x = -2, x = 2$
 As $x \rightarrow -2^-, f(x) \rightarrow -\infty$
 As $x \rightarrow -2^+, f(x) \rightarrow \infty$
 As $x \rightarrow 2^-, f(x) \rightarrow -\infty$
 As $x \rightarrow 2^+, f(x) \rightarrow \infty$
 No holes in the graph
 Horizontal asymptote: $y = 0$
 As $x \rightarrow -\infty, f(x) \rightarrow 0^-$
 As $x \rightarrow \infty, f(x) \rightarrow 0^+$
9. $f(x) = \frac{x^2 - x - 12}{x^2 + x - 6} = \frac{x - 4}{x - 2}$
 Domain: $(-\infty, -3) \cup (-3, 2) \cup (2, \infty)$
 Vertical asymptote: $x = 2$
 As $x \rightarrow 2^-, f(x) \rightarrow \infty$
 As $x \rightarrow 2^+, f(x) \rightarrow -\infty$
 Hole at $(-3, \frac{7}{5})$
 Horizontal asymptote: $y = 1$
 As $x \rightarrow -\infty, f(x) \rightarrow 1^+$
 As $x \rightarrow \infty, f(x) \rightarrow 1^-$
10. $f(x) = \frac{3x^2 - 5x - 2}{x^2 - 9} = \frac{(3x + 1)(x - 2)}{(x + 3)(x - 3)}$
 Domain: $(-\infty, -3) \cup (-3, 3) \cup (3, \infty)$
 Vertical asymptotes: $x = -3, x = 3$
 As $x \rightarrow -3^-, f(x) \rightarrow \infty$
 As $x \rightarrow -3^+, f(x) \rightarrow -\infty$
 As $x \rightarrow 3^-, f(x) \rightarrow -\infty$
 As $x \rightarrow 3^+, f(x) \rightarrow \infty$
 No holes in the graph
 Horizontal asymptote: $y = 3$
 As $x \rightarrow -\infty, f(x) \rightarrow 3^+$
 As $x \rightarrow \infty, f(x) \rightarrow 3^-$
11. $f(x) = \frac{x^3 + 2x^2 + x}{x^2 - x - 2} = \frac{x(x + 1)}{x - 2}$
 Domain: $(-\infty, -1) \cup (-1, 2) \cup (2, \infty)$
 Vertical asymptote: $x = 2$
 As $x \rightarrow 2^-, f(x) \rightarrow -\infty$
 As $x \rightarrow 2^+, f(x) \rightarrow \infty$
 Hole at $(-1, 0)$
 Slant asymptote: $y = x + 3$
 As $x \rightarrow -\infty$, the graph is below $y = x + 3$
 As $x \rightarrow \infty$, the graph is above $y = x + 3$
12. $f(x) = \frac{x^3 - 3x + 1}{x^2 + 1}$
 Domain: $(-\infty, \infty)$
 No vertical asymptotes
 No holes in the graph
 Slant asymptote: $y = x$
 As $x \rightarrow -\infty$, the graph is above $y = x$
 As $x \rightarrow \infty$, the graph is below $y = x$

13. $f(x) = \frac{2x^2 + 5x - 3}{3x + 2}$
 Domain: $(-\infty, -\frac{2}{3}) \cup (-\frac{2}{3}, \infty)$
 Vertical asymptote: $x = -\frac{2}{3}$
 As $x \rightarrow -\frac{2}{3}^-$, $f(x) \rightarrow \infty$
 As $x \rightarrow -\frac{2}{3}^+$, $f(x) \rightarrow -\infty$
 No holes in the graph
 Slant asymptote: $y = \frac{2}{3}x + \frac{11}{9}$
 As $x \rightarrow -\infty$, the graph is above $y = \frac{2}{3}x + \frac{11}{9}$
 As $x \rightarrow \infty$, the graph is below $y = \frac{2}{3}x + \frac{11}{9}$
14. $f(x) = \frac{-x^3 + 4x}{x^2 - 9} = \frac{-x^3 + 4x}{(x - 3)(x + 3)}$
 Domain: $(-\infty, -3) \cup (-3, 3) \cup (3, \infty)$
 Vertical asymptotes: $x = -3, x = 3$
 As $x \rightarrow -3^-$, $f(x) \rightarrow \infty$
 As $x \rightarrow -3^+$, $f(x) \rightarrow -\infty$
 As $x \rightarrow 3^-$, $f(x) \rightarrow \infty$
 As $x \rightarrow 3^+$, $f(x) \rightarrow -\infty$
 No holes in the graph
 Slant asymptote: $y = -x$
 As $x \rightarrow -\infty$, the graph is above $y = -x$
 As $x \rightarrow \infty$, the graph is below $y = -x$
15. $f(x) = \frac{-5x^4 - 3x^3 + x^2 - 10}{x^3 - 3x^2 + 3x - 1}$
 $= \frac{-5x^4 - 3x^3 + x^2 - 10}{(x - 1)^3}$
 Domain: $(-\infty, 1) \cup (1, \infty)$
 Vertical asymptotes: $x = 1$
 As $x \rightarrow 1^-$, $f(x) \rightarrow \infty$
 As $x \rightarrow 1^+$, $f(x) \rightarrow -\infty$
 No holes in the graph
 Slant asymptote: $y = -5x - 18$
 As $x \rightarrow -\infty$, the graph is above $y = -5x - 18$
 As $x \rightarrow \infty$, the graph is below $y = -5x - 18$
16. $f(x) = \frac{x^3}{1 - x}$
 Domain: $(-\infty, 1) \cup (1, \infty)$
 Vertical asymptote: $x = 1$
 As $x \rightarrow 1^-$, $f(x) \rightarrow \infty$
 As $x \rightarrow 1^+$, $f(x) \rightarrow -\infty$
 No holes in the graph
 No horizontal or slant asymptote
 As $x \rightarrow -\infty$, $f(x) \rightarrow -\infty$
 As $x \rightarrow \infty$, $f(x) \rightarrow -\infty$
17. $f(x) = \frac{18 - 2x^2}{x^2 - 9} = -2$
 Domain: $(-\infty, -3) \cup (-3, 3) \cup (3, \infty)$
 No vertical asymptotes
 Holes in the graph at $(-3, -2)$ and $(3, -2)$
 Horizontal asymptote $y = -2$
 As $x \rightarrow \pm\infty$, $f(x) = -2$
18. $f(x) = \frac{x^3 - 4x^2 - 4x - 5}{x^2 + x + 1} = x - 5$
 Domain: $(-\infty, \infty)$
 No vertical asymptotes
 No holes in the graph
 Slant asymptote: $y = x - 5$
 $f(x) = x - 5$ everywhere.
19. (a) $C(25) = 590$ means it costs \$590 to remove 25% of the fish and $C(95) = 33630$ means it would cost \$33630 to remove 95% of the fish from the pond.
 (b) The vertical asymptote at $x = 100$ means that as we try to remove 100% of the fish from the pond, the cost increases without bound; i.e., it's impossible to remove all of the fish.
 (c) For \$40000 you could remove about 95.76% of the fish.

20. The horizontal asymptote of the graph of $P(t) = \frac{150t}{t+15}$ is $y = 150$ and it means that the model predicts the population of Sasquatch in Portage County will never exceed 150.
21. (a) $\bar{C}(x) = \frac{100x+2000}{x}$, $x > 0$.
- (b) $\bar{C}(1) = 2100$ and $\bar{C}(100) = 120$. When just 1 dOpi is produced, the cost per dOpi is \$2100, but when 100 dOpis are produced, the cost per dOpi is \$120.
- (c) $\bar{C}(x) = 200$ when $x = 20$. So to get the cost per dOpi to \$200, 20 dOpis need to be produced.
- (d) As $x \rightarrow 0^+$, $\bar{C}(x) \rightarrow \infty$. This means that as fewer and fewer dOpis are produced, the cost per dOpi becomes unbounded. In this situation, there is a fixed cost of \$2000 ($C(0) = 2000$), we are trying to spread that \$2000 over fewer and fewer dOpis.
- (e) As $x \rightarrow \infty$, $\bar{C}(x) \rightarrow 100^+$. This means that as more and more dOpis are produced, the cost per dOpi approaches \$100, but is always a little more than \$100. Since \$100 is the variable cost per dOpi ($C(x) = 100x + 2000$), it means that no matter how many dOpis are produced, the average cost per dOpi will always be a bit higher than the variable cost to produce a dOpi. As before, we can attribute this to the \$2000 fixed cost, which factors into the average cost per dOpi no matter how many dOpis are produced.

22. (a)

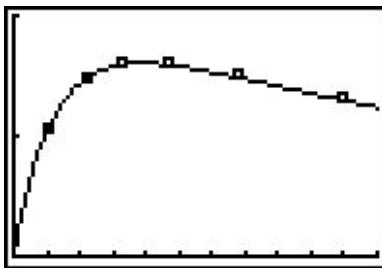

- (b) The maximum power is approximately 1.603 mW which corresponds to $3.9 \text{ k}\Omega$.
- (c) As $x \rightarrow \infty$, $P(x) \rightarrow 0^+$ which means as the resistance increases without bound, the power diminishes to zero.

4.2 GRAPHS OF RATIONAL FUNCTIONS

In this section, we take a closer look at graphing rational functions. In Section 4.1, we learned that the graphs of rational functions may have holes in them and could have vertical, horizontal and slant asymptotes. Theorems 4.1, 4.2 and 4.3 tell us exactly when and where these behaviors will occur, and if we combine these results with what we already know about graphing functions, we will quickly be able to generate reasonable graphs of rational functions.

One of the standard tools we will use is the sign diagram which was first introduced in Section 2.4, and then revisited in Section 3.1. In those sections, we operated under the belief that a function couldn't change its sign without its graph crossing through the x -axis. The major theorem we used to justify this belief was the Intermediate Value Theorem, Theorem 3.1. It turns out the Intermediate Value Theorem applies to all *continuous* functions,¹ not just polynomials. Although rational functions are continuous on their domains,² Theorem 4.1 tells us that vertical asymptotes and holes occur at the values excluded from their domains. In other words, rational functions aren't continuous at these excluded values which leaves open the possibility that the function could change sign *without* crossing through the x -axis. Consider the graph of $y = h(x)$ from Example 4.1.1, recorded below for convenience. We have added its x -intercept at $(\frac{1}{2}, 0)$ for the discussion that follows. Suppose we wish to construct a sign diagram for $h(x)$. Recall that the intervals where $h(x) > 0$, or (+), correspond to the x -values where the graph of $y = h(x)$ is *above* the x -axis; the intervals on which $h(x) < 0$, or (-) correspond to where the graph is *below* the x -axis.

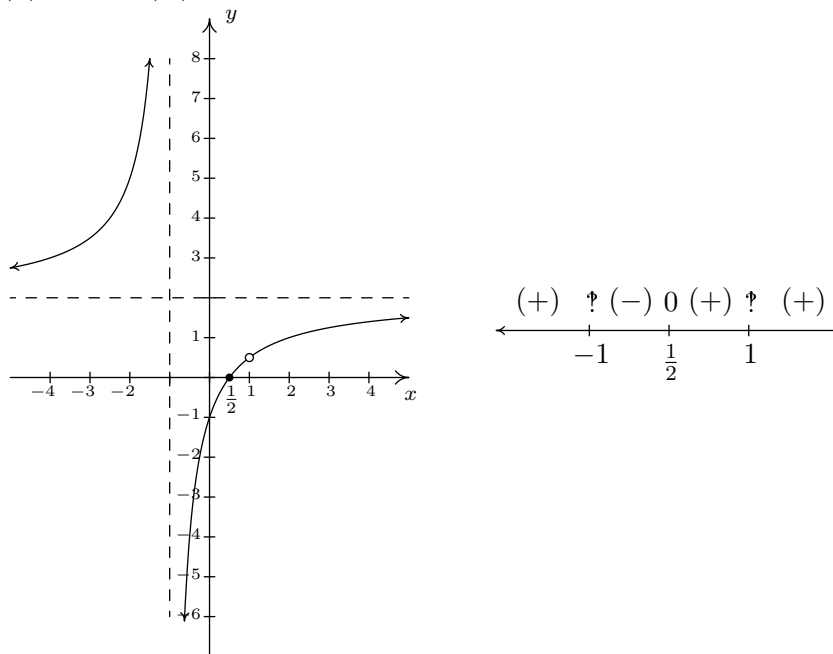

As we examine the graph of $y = h(x)$, reading from left to right, we note that from $(-\infty, -1)$, the graph is above the x -axis, so $h(x)$ is (+) there. At $x = -1$, we have a vertical asymptote, at which point the graph 'jumps' across the x -axis. On the interval $(-1, \frac{1}{2})$, the graph is below the

¹Recall that, for our purposes, this means the graphs are devoid of any breaks, jumps or holes

²Another result from Calculus.

x -axis, so $h(x)$ is $(-)$ there. The graph crosses through the x -axis at $(\frac{1}{2}, 0)$ and remains above the x -axis until $x = 1$, where we have a ‘hole’ in the graph. Since $h(1)$ is undefined, there is no sign here. So we have $h(x)$ as $(+)$ on the interval $(\frac{1}{2}, 1)$. Continuing, we see that on $(1, \infty)$, the graph of $y = h(x)$ is above the x -axis, so we mark $(+)$ there. To construct a sign diagram from this information, we not only need to denote the zero of h , but also the places not in the domain of h . As is our custom, we write ‘0’ above $\frac{1}{2}$ on the sign diagram to remind us that it is a zero of h . We need a different notation for -1 and 1 , and we have chosen to use ‘?’ - a nonstandard symbol called the [interrobang](#). We use this symbol to convey a sense of surprise, caution and wonderment - an appropriate attitude to take when approaching these points. The moral of the story is that when constructing sign diagrams for rational functions, we include the zeros as well as the values excluded from the domain.

Steps for Constructing a Sign Diagram for a Rational Function

Suppose r is a rational function.

1. Place any values excluded from the domain of r on the number line with an ‘?’ above them.
2. Find the zeros of r and place them on the number line with the number 0 above them.
3. Choose a test value in each of the intervals determined in steps 1 and 2.
4. Determine the sign of $r(x)$ for each test value in step 3, and write that sign above the corresponding interval.

We now present our procedure for graphing rational functions and apply it to a few exhaustive examples. Please note that we decrease the amount of detail given in the explanations as we move through the examples. The reader should be able to fill in any details in those steps which we have abbreviated.

Steps for Graphing Rational Functions

Suppose r is a rational function.

1. Find the domain of r .
2. Reduce $r(x)$ to lowest terms, if applicable.
3. Find the x - and y -intercepts of the graph of $y = r(x)$, if they exist.
4. Determine the location of any vertical asymptotes or holes in the graph, if they exist. Analyze the behavior of r on either side of the vertical asymptotes, if applicable.
5. Analyze the end behavior of r . Find the horizontal or slant asymptote, if one exists.
6. Use a sign diagram and plot additional points, as needed, to sketch the graph of $y = r(x)$.

Example 4.2.1. Sketch a detailed graph of $f(x) = \frac{3x}{x^2 - 4}$.

Solution. We follow the six step procedure outlined above.

1. As usual, we set the denominator equal to zero to get $x^2 - 4 = 0$. We find $x = \pm 2$, so our domain is $(-\infty, -2) \cup (-2, 2) \cup (2, \infty)$.
2. To reduce $f(x)$ to lowest terms, we factor the numerator and denominator which yields $f(x) = \frac{3x}{(x-2)(x+2)}$. There are no common factors which means $f(x)$ is already in lowest terms.
3. To find the x -intercepts of the graph of $y = f(x)$, we set $y = f(x) = 0$. Solving $\frac{3x}{(x-2)(x+2)} = 0$ results in $x = 0$. Since $x = 0$ is in our domain, $(0, 0)$ is the x -intercept. To find the y -intercept, we set $x = 0$ and find $y = f(0) = 0$, so that $(0, 0)$ is our y -intercept as well.³
4. The two numbers excluded from the domain of f are $x = -2$ and $x = 2$. Since $f(x)$ didn't reduce at all, both of these values of x still cause trouble in the denominator. Thus by Theorem 4.1, $x = -2$ and $x = 2$ are vertical asymptotes of the graph. We can actually go a step further at this point and determine exactly how the graph approaches the asymptote near each of these values. Though not absolutely necessary,⁴ it is good practice for those heading off to Calculus. For the discussion that follows, it is best to use the factored form of $f(x) = \frac{3x}{(x-2)(x+2)}$.

- *The behavior of $y = f(x)$ as $x \rightarrow -2$:* Suppose $x \rightarrow -2^-$. If we were to build a table of values, we'd use x -values a little less than -2 , say -2.1 , -2.01 and -2.001 . While there is no harm in actually building a table like we did in Section 4.1, we want to develop a 'number sense' here. Let's think about each factor in the formula of $f(x)$ as we imagine substituting a number like $x = -2.000001$ into $f(x)$. The quantity $3x$ would be very close to -6 , the quantity $(x - 2)$ would be very close to -4 , and the factor $(x + 2)$ would be very close to 0 . More specifically, $(x + 2)$ would be a little less than 0 , in this case, -0.000001 . We will call such a number a 'very small (-)', 'very small' meaning close to zero in absolute value. So, mentally, as $x \rightarrow -2^-$, we estimate

$$f(x) = \frac{3x}{(x-2)(x+2)} \approx \frac{-6}{(-4)(\text{very small } (-))} = \frac{3}{2(\text{very small } (-))}$$

Now, the closer x gets to -2 , the smaller $(x + 2)$ will become, so even though we are multiplying our 'very small (-)' by 2, the denominator will continue to get smaller and smaller, and remain negative. The result is a fraction whose numerator is positive, but whose denominator is very small and negative. Mentally,

$$f(x) \approx \frac{3}{2(\text{very small } (-))} \approx \frac{3}{\text{very small } (-)} \approx \text{very big } (-)$$

³As we mentioned at least once earlier, since functions can have at most one y -intercept, once we find that $(0, 0)$ is on the graph, we know it is the y -intercept.

⁴The sign diagram in step 6 will also determine the behavior near the vertical asymptotes.

The term ‘very big (-)’ means a number with a large absolute value which is negative.⁵ What all of this means is that as $x \rightarrow -2^-$, $f(x) \rightarrow -\infty$. Now suppose we wanted to determine the behavior of $f(x)$ as $x \rightarrow -2^+$. If we imagine substituting something a little larger than -2 in for x , say -1.999999 , we mentally estimate

$$f(x) \approx \frac{-6}{(-4) \text{ (very small (+))}} = \frac{3}{2 \text{ (very small (+))}} \approx \frac{3}{\text{very small (+)}} \approx \text{very big (+)}$$

We conclude that as $x \rightarrow -2^+$, $f(x) \rightarrow \infty$.

- *The behavior of $y = f(x)$ as $x \rightarrow 2$:* Consider $x \rightarrow 2^-$. We imagine substituting $x = 1.999999$. Approximating $f(x)$ as we did above, we get

$$f(x) \approx \frac{6}{(\text{very small (-)}) (4)} = \frac{3}{2 \text{ (very small (-))}} \approx \frac{3}{\text{very small (-)}} \approx \text{very big (-)}$$

We conclude that as $x \rightarrow 2^-$, $f(x) \rightarrow -\infty$. Similarly, as $x \rightarrow 2^+$, we imagine substituting $x = 2.000001$ to get $f(x) \approx \frac{3}{\text{very small (+)}} \approx \text{very big (+)}$. So as $x \rightarrow 2^+$, $f(x) \rightarrow \infty$.

Graphically, we have that near $x = -2$ and $x = 2$ the graph of $y = f(x)$ looks like⁶

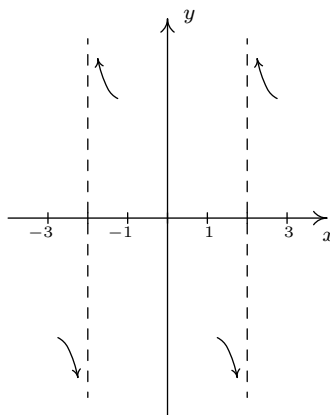

5. Next, we determine the end behavior of the graph of $y = f(x)$. Since the degree of the numerator is 1, and the degree of the denominator is 2, Theorem 4.2 tells us that $y = 0$ is the horizontal asymptote. As with the vertical asymptotes, we can glean more detailed information using ‘number sense’. For the discussion below, we use the formula $f(x) = \frac{3x}{x^2-4}$.

- *The behavior of $y = f(x)$ as $x \rightarrow -\infty$:* If we were to make a table of values to discuss the behavior of f as $x \rightarrow -\infty$, we would substitute very ‘large’ negative numbers in for x , say for example, $x = -1$ billion. The numerator $3x$ would then be -3 billion, whereas

⁵The actual retail value of $f(-2.000001)$ is approximately $-1,500,000$.

⁶We have deliberately left off the labels on the y -axis because we know only the behavior near $x = \pm 2$, not the actual function values.

the denominator $x^2 - 4$ would be $(-1 \text{ billion})^2 - 4$, which is pretty much the same as $1(\text{billion})^2$. Hence,

$$f(-1 \text{ billion}) \approx \frac{-3 \text{ billion}}{1(\text{billion})^2} \approx -\frac{3}{\text{billion}} \approx \text{very small } (-)$$

Notice that if we substituted in $x = -1$ trillion, essentially the same kind of cancellation would happen, and we would be left with an even ‘smaller’ negative number. This not only confirms the fact that as $x \rightarrow -\infty$, $f(x) \rightarrow 0$, it tells us that $f(x) \rightarrow 0^-$. In other words, the graph of $y = f(x)$ is a little bit *below* the x -axis as we move to the far left.

- *The behavior of $y = f(x)$ as $x \rightarrow \infty$:* On the flip side, we can imagine substituting very large positive numbers in for x and looking at the behavior of $f(x)$. For example, let $x = 1$ billion. Proceeding as before, we get

$$f(1 \text{ billion}) \approx \frac{3 \text{ billion}}{1(\text{billion})^2} \approx \frac{3}{\text{billion}} \approx \text{very small } (+)$$

The larger the number we put in, the smaller the positive number we would get out. In other words, as $x \rightarrow \infty$, $f(x) \rightarrow 0^+$, so the graph of $y = f(x)$ is a little bit *above* the x -axis as we look toward the far right.

Graphically, we have⁷

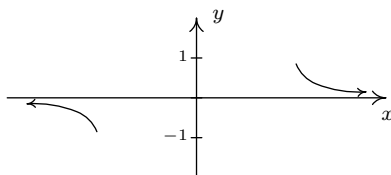

6. Lastly, we construct a sign diagram for $f(x)$. The x -values excluded from the domain of f are $x = \pm 2$, and the only zero of f is $x = 0$. Displaying these appropriately on the number line gives us four test intervals, and we choose the test values⁸ $x = -3$, $x = -1$, $x = 1$ and $x = 3$. We find $f(-3)$ is $(-)$, $f(-1)$ is $(+)$, $f(1)$ is $(-)$ and $f(3)$ is $(+)$. Combining this with our previous work, we get the graph of $y = f(x)$ below.

⁷As with the vertical asymptotes in the previous step, we know only the behavior of the graph as $x \rightarrow \pm\infty$. For that reason, we provide no x -axis labels.

⁸In this particular case, we can eschew test values, since our analysis of the behavior of f near the vertical asymptotes and our end behavior analysis have given us the signs on each of the test intervals. In general, however, this won't always be the case, so for demonstration purposes, we continue with our usual construction.

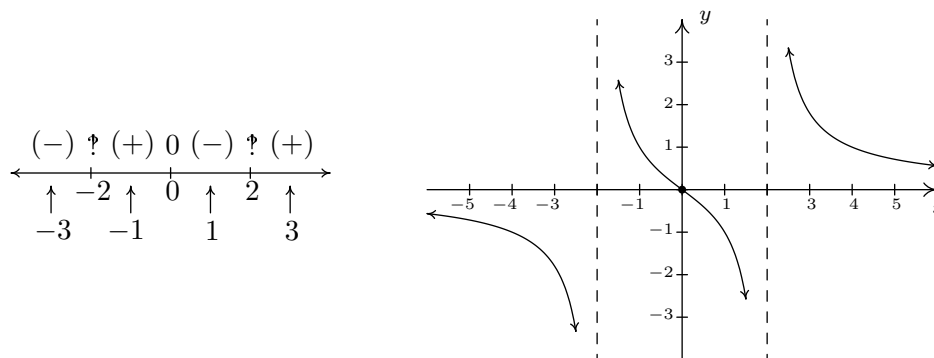

□

A couple of notes are in order. First, the graph of $y = f(x)$ certainly seems to possess symmetry with respect to the origin. In fact, we can check $f(-x) = -f(x)$ to see that f is an odd function. In some textbooks, checking for symmetry is part of the standard procedure for graphing rational functions; but since it happens comparatively rarely⁹ we'll just point it out when we see it. Also note that while $y = 0$ is the horizontal asymptote, the graph of f actually crosses the x -axis at $(0, 0)$. The myth that graphs of rational functions can't cross their horizontal asymptotes is completely false,¹⁰ as we shall see again in our next example.

Example 4.2.2. Sketch a detailed graph of $g(x) = \frac{2x^2 - 3x - 5}{x^2 - x - 6}$.

Solution.

1. Setting $x^2 - x - 6 = 0$ gives $x = -2$ and $x = 3$. Our domain is $(-\infty, -2) \cup (-2, 3) \cup (3, \infty)$.
2. Factoring $g(x)$ gives $g(x) = \frac{(2x-5)(x+1)}{(x-3)(x+2)}$. There is no cancellation, so $g(x)$ is in lowest terms.
3. To find the x -intercept we set $y = g(x) = 0$. Using the factored form of $g(x)$ above, we find the zeros to be the solutions of $(2x - 5)(x + 1) = 0$. We obtain $x = \frac{5}{2}$ and $x = -1$. Since both of these numbers are in the domain of g , we have two x -intercepts, $(\frac{5}{2}, 0)$ and $(-1, 0)$. To find the y -intercept, we set $x = 0$ and find $y = g(0) = \frac{5}{6}$, so our y -intercept is $(0, \frac{5}{6})$.
4. Since $g(x)$ was given to us in lowest terms, we have, once again by Theorem 4.1 vertical asymptotes $x = -2$ and $x = 3$. Keeping in mind $g(x) = \frac{(2x-5)(x+1)}{(x-3)(x+2)}$, we proceed to our analysis near each of these values.

- *The behavior of $y = g(x)$ as $x \rightarrow -2$:* As $x \rightarrow -2^-$, we imagine substituting a number a little bit less than -2 . We have

$$g(x) \approx \frac{(-9)(-1)}{(-5)(\text{very small } (-))} \approx \frac{9}{\text{very small } (+)} \approx \text{very big } (+)$$

⁹And Jeff doesn't think much of it to begin with...

¹⁰That's why we called it a MYTH!

so as $x \rightarrow -2^-$, $g(x) \rightarrow \infty$. On the flip side, as $x \rightarrow -2^+$, we get

$$g(x) \approx \frac{9}{\text{very small } (-)} \approx \text{very big } (-)$$

so $g(x) \rightarrow -\infty$.

- *The behavior of $y = g(x)$ as $x \rightarrow 3$:* As $x \rightarrow 3^-$, we imagine plugging in a number just shy of 3. We have

$$g(x) \approx \frac{(1)(4)}{(\text{very small } (-))(5)} \approx \frac{4}{\text{very small } (-)} \approx \text{very big } (-)$$

Hence, as $x \rightarrow 3^-$, $g(x) \rightarrow -\infty$. As $x \rightarrow 3^+$, we get

$$g(x) \approx \frac{4}{\text{very small } (+)} \approx \text{very big } (+)$$

so $g(x) \rightarrow \infty$.

Graphically, we have (again, without labels on the y -axis)

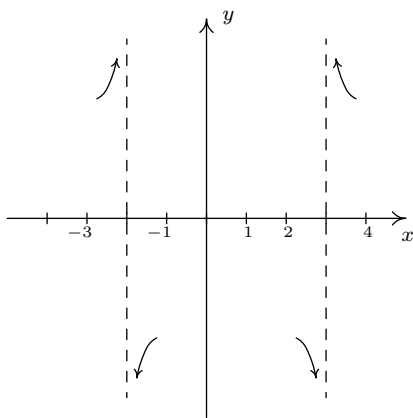

5. Since the degrees of the numerator and denominator of $g(x)$ are the same, we know from Theorem 4.2 that we can find the horizontal asymptote of the graph of g by taking the ratio of the leading terms coefficients, $y = \frac{2}{1} = 2$. However, if we take the time to do a more detailed analysis, we will be able to reveal some ‘hidden’ behavior which would be lost otherwise.¹¹ As in the discussion following Theorem 4.2, we use the result of the long division $(2x^2 - 3x - 5) \div (x^2 - x - 6)$ to rewrite $g(x) = \frac{2x^2 - 3x - 5}{x^2 - x - 6}$ as $g(x) = 2 - \frac{x-7}{x^2-x-6}$. We focus our attention on the term $\frac{x-7}{x^2-x-6}$.

¹¹That is, if you use a calculator to graph. Once again, Calculus is the ultimate graphing power tool.

- *The behavior of $y = g(x)$ as $x \rightarrow -\infty$:* If imagine substituting $x = -1$ billion into $\frac{x-7}{x^2-x-6}$, we estimate $\frac{x-7}{x^2-x-6} \approx \frac{-1 \text{ billion}}{1 \text{ billion}^2} \approx \text{very small } (-)$.¹² Hence,

$$g(x) = 2 - \frac{x-7}{x^2-x-6} \approx 2 - \text{very small } (-) = 2 + \text{very small } (+)$$

In other words, as $x \rightarrow -\infty$, the graph of $y = g(x)$ is a little bit *above* the line $y = 2$.

- *The behavior of $y = g(x)$ as $x \rightarrow \infty$.* To consider $\frac{x-7}{x^2-x-6}$ as $x \rightarrow \infty$, we imagine substituting $x = 1$ billion and, going through the usual mental routine, find

$$\frac{x-7}{x^2-x-6} \approx \text{very small } (+)$$

Hence, $g(x) \approx 2 - \text{very small } (+)$, in other words, the graph of $y = g(x)$ is just *below* the line $y = 2$ as $x \rightarrow \infty$.

On $y = g(x)$, we have (again, without labels on the x -axis)

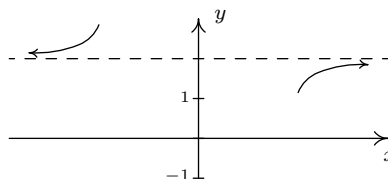

6. Finally we construct our sign diagram. We place an ‘?’ above $x = -2$ and $x = 3$, and a ‘0’ above $x = \frac{5}{2}$ and $x = -1$. Choosing test values in the test intervals gives us $f(x)$ is (+) on the intervals $(-\infty, -2)$, $(-1, \frac{5}{2})$ and $(3, \infty)$, and (-) on the intervals $(-2, -1)$ and $(\frac{5}{2}, 3)$. As we piece together all of the information, we note that the graph must cross the horizontal asymptote at some point after $x = 3$ in order for it to approach $y = 2$ from underneath. This is the subtlety that we would have missed had we skipped the long division and subsequent end behavior analysis. We can, in fact, find exactly when the graph crosses $y = 2$. As a result of the long division, we have $g(x) = 2 - \frac{x-7}{x^2-x-6}$. For $g(x) = 2$, we would need $\frac{x-7}{x^2-x-6} = 0$. This gives $x - 7 = 0$, or $x = 7$. Note that $x - 7$ is the remainder when $2x^2 - 3x - 5$ is divided by $x^2 - x - 6$, so it makes sense that for $g(x)$ to equal the quotient 2, the remainder from the division must be 0. Sure enough, we find $g(7) = 2$. Moreover, it stands to reason that g must attain a relative minimum at some point past $x = 7$. Calculus verifies that at $x = 13$, we have such a minimum at exactly $(13, 1.96)$. The reader is challenged to find calculator windows which show the graph crossing its horizontal asymptote on one window, and the relative minimum in the other.

¹²In the denominator, we would have $(1 \text{ billion})^2 - 1 \text{ billion} - 6$. It’s easy to see why the 6 is insignificant, but to ignore the 1 billion seems criminal. However, compared to $(1 \text{ billion})^2$, it’s on the insignificant side; it’s 10^{18} versus 10^9 . We are once again using the fact that for polynomials, end behavior is determined by the leading term, so in the denominator, the x^2 term wins out over the x term.

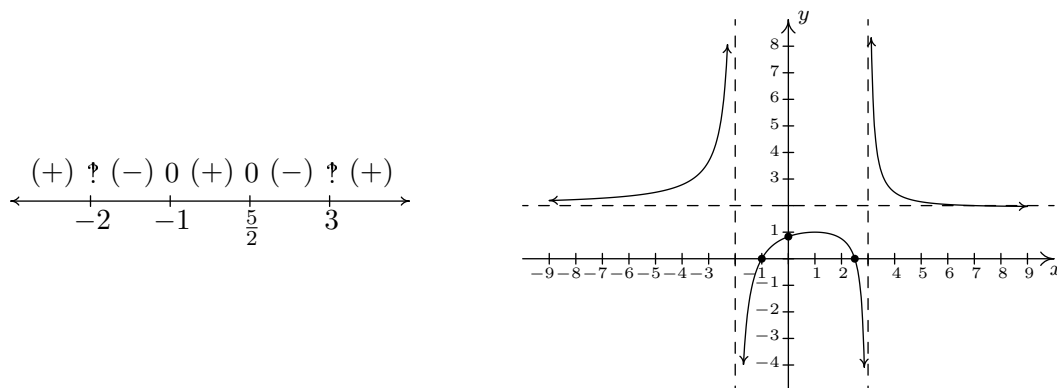

□

Our next example gives us an opportunity to more thoroughly analyze a slant asymptote.

Example 4.2.3. Sketch a detailed graph of $h(x) = \frac{2x^3 + 5x^2 + 4x + 1}{x^2 + 3x + 2}$.

Solution.

1. For domain, you know the drill. Solving $x^2 + 3x + 2 = 0$ gives $x = -2$ and $x = -1$. Our answer is $(-\infty, -2) \cup (-2, -1) \cup (-1, \infty)$.
2. To reduce $h(x)$, we need to factor the numerator and denominator. To factor the numerator, we use the techniques¹³ set forth in Section 3.3 and we get

$$h(x) = \frac{2x^3 + 5x^2 + 4x + 1}{x^2 + 3x + 2} = \frac{(2x + 1)(x + 1)^2}{(x + 2)(x + 1)} = \frac{(2x + 1)(x + 1)^{\cancel{2}^1}}{(x + 2)(\cancel{x + 1})} = \frac{(2x + 1)(x + 1)}{x + 2}$$

We will use this reduced formula for $h(x)$ as long as we're not substituting $x = -1$. To make this exclusion specific, we write $h(x) = \frac{(2x+1)(x+1)}{x+2}$, $x \neq -1$.

3. To find the x -intercepts, as usual, we set $h(x) = 0$ and solve. Solving $\frac{(2x+1)(x+1)}{x+2} = 0$ yields $x = -\frac{1}{2}$ and $x = -1$. The latter isn't in the domain of h , so we exclude it. Our only x -intercept is $(-\frac{1}{2}, 0)$. To find the y -intercept, we set $x = 0$. Since $0 \neq -1$, we can use the reduced formula for $h(x)$ and we get $h(0) = \frac{1}{2}$ for a y -intercept of $(0, \frac{1}{2})$.
4. From Theorem 4.1, we know that since $x = -2$ still poses a threat in the denominator of the reduced function, we have a vertical asymptote there. As for $x = -1$, the factor $(x + 1)$ was canceled from the denominator when we reduced $h(x)$, so it no longer causes trouble there. This means that we get a hole when $x = -1$. To find the y -coordinate of the hole, we substitute $x = -1$ into $\frac{(2x+1)(x+1)}{x+2}$, per Theorem 4.1 and get 0. Hence, we have a hole on

¹³But you never thought you'd never see *that* stuff again before the Final Exam!

the x -axis at $(-1, 0)$. It should make you uncomfortable plugging $x = -1$ into the reduced formula for $h(x)$, especially since we've made such a big deal concerning the stipulation about not letting $x = -1$ for that formula. What we are really doing is taking a Calculus short-cut to the more detailed kind of analysis near $x = -1$ which we will show below. Speaking of which, for the discussion that follows, we will use the formula $h(x) = \frac{(2x+1)(x+1)}{x+2}$, $x \neq -1$.

- *The behavior of $y = h(x)$ as $x \rightarrow -2$:* As $x \rightarrow -2^-$, we imagine substituting a number a little bit less than -2 . We have $h(x) \approx \frac{(-3)(-1)}{\text{very small } (-)} \approx \frac{3}{\text{very small } (-)} \approx \text{very big } (-)$ thus as $x \rightarrow -2^-$, $h(x) \rightarrow -\infty$. On the other side of -2 , as $x \rightarrow -2^+$, we find that $h(x) \approx \frac{3}{\text{very small } (+)} \approx \text{very big } (+)$, so $h(x) \rightarrow \infty$.
- *The behavior of $y = h(x)$ as $x \rightarrow -1$.* As $x \rightarrow -1^-$, we imagine plugging in a number a bit less than $x = -1$. We have $h(x) \approx \frac{(-1)(\text{very small } (-))}{1} = \text{very small } (+)$ Hence, as $x \rightarrow -1^-$, $h(x) \rightarrow 0^+$. This means that as $x \rightarrow -1^-$, the graph is a bit above the point $(-1, 0)$. As $x \rightarrow -1^+$, we get $h(x) \approx \frac{(-1)(\text{very small } (+))}{1} = \text{very small } (-)$. This gives us that as $x \rightarrow -1^+$, $h(x) \rightarrow 0^-$, so the graph is a little bit lower than $(-1, 0)$ here.

Graphically, we have

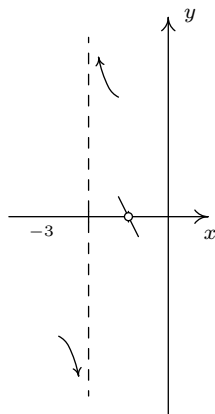

5. For end behavior, we note that the degree of the numerator of $h(x)$, $2x^3 + 5x^2 + 4x + 1$, is 3 and the degree of the denominator, $x^2 + 3x + 2$, is 2 so by Theorem 4.3, the graph of $y = h(x)$ has a slant asymptote. For $x \rightarrow \pm\infty$, we are far enough away from $x = -1$ to use the reduced formula, $h(x) = \frac{(2x+1)(x+1)}{x+2}$, $x \neq -1$. To perform long division, we multiply out the numerator and get $h(x) = \frac{2x^2+3x+1}{x+2}$, $x \neq -1$, and rewrite $h(x) = 2x - 1 + \frac{3}{x+2}$, $x \neq -1$. By Theorem 4.3, the slant asymptote is $y = 2x - 1$, and to better see *how* the graph approaches the asymptote, we focus our attention on the term generated from the remainder, $\frac{3}{x+2}$.

- *The behavior of $y = h(x)$ as $x \rightarrow -\infty$:* Substituting $x = -1$ billion into $\frac{3}{x+2}$, we get the estimate $\frac{3}{-1 \text{ billion}} \approx \text{very small } (-)$. Hence, $h(x) = 2x - 1 + \frac{3}{x+2} \approx 2x - 1 + \text{very small } (-)$. This means the graph of $y = h(x)$ is a little bit *below* the line $y = 2x - 1$ as $x \rightarrow -\infty$.

- *The behavior of $y = h(x)$ as $x \rightarrow \infty$:* If $x \rightarrow \infty$, then $\frac{3}{x+2} \approx$ very small (+). This means $h(x) \approx 2x - 1 +$ very small (+), or that the graph of $y = h(x)$ is a little bit *above* the line $y = 2x - 1$ as $x \rightarrow \infty$.

Graphically we have

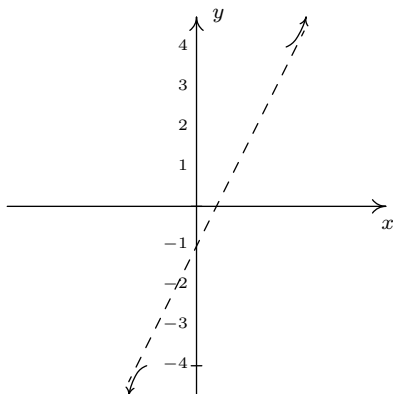

6. To make our sign diagram, we place an ‘?’ above $x = -2$ and $x = -1$ and a ‘0’ above $x = -\frac{1}{2}$. On our four test intervals, we find $h(x)$ is (+) on $(-2, -1)$ and $(-\frac{1}{2}, \infty)$ and $h(x)$ is (-) on $(-\infty, -2)$ and $(-1, -\frac{1}{2})$. Putting all of our work together yields the graph below.

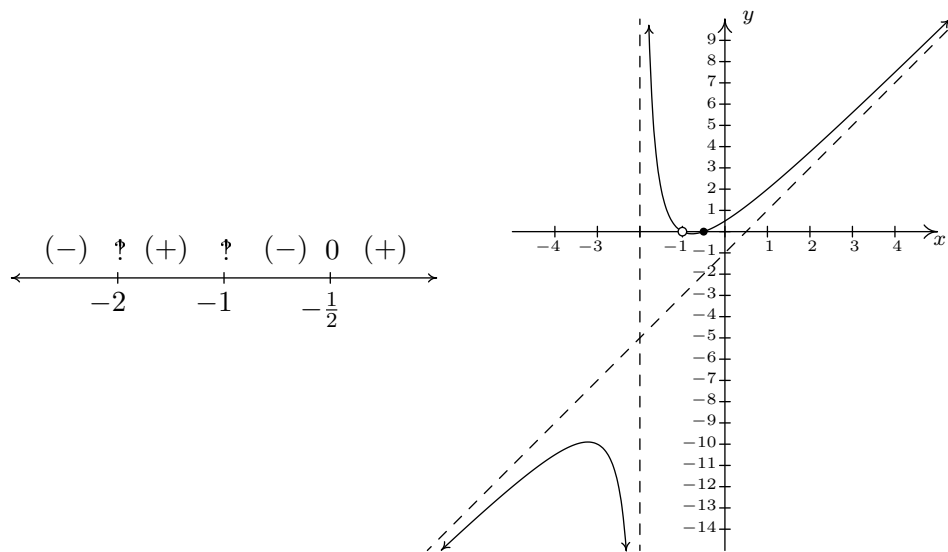

We could ask whether the graph of $y = h(x)$ crosses its slant asymptote. From the formula $h(x) = 2x - 1 + \frac{3}{x+2}$, $x \neq -1$, we see that if $h(x) = 2x - 1$, we would have $\frac{3}{x+2} = 0$. Since this will never happen, we conclude the graph never crosses its slant asymptote.¹⁴ \square

¹⁴But rest assured, some graphs do!

We end this section with an example that shows it's not all pathological weirdness when it comes to rational functions and technology still has a role to play in studying their graphs at this level.

Example 4.2.4. Sketch the graph of $r(x) = \frac{x^4 + 1}{x^2 + 1}$.

Solution.

1. The denominator $x^2 + 1$ is never zero so the domain is $(-\infty, \infty)$.
2. With no real zeros in the denominator, $x^2 + 1$ is an irreducible quadratic. Our only hope of reducing $r(x)$ is if $x^2 + 1$ is a factor of $x^4 + 1$. Performing long division gives us

$$\frac{x^4 + 1}{x^2 + 1} = x^2 - 1 + \frac{2}{x^2 + 1}$$

The remainder is not zero so $r(x)$ is already reduced.

3. To find the x -intercept, we'd set $r(x) = 0$. Since there are no real solutions to $\frac{x^4+1}{x^2+1} = 0$, we have no x -intercepts. Since $r(0) = 1$, we get $(0, 1)$ as the y -intercept.
4. This step doesn't apply to r , since its domain is all real numbers.
5. For end behavior, we note that since the degree of the numerator is exactly *two* more than the degree of the denominator, neither Theorems 4.2 nor 4.3 apply.¹⁵ We know from our attempt to reduce $r(x)$ that we can rewrite $r(x) = x^2 - 1 + \frac{2}{x^2+1}$, so we focus our attention on the term corresponding to the remainder, $\frac{2}{x^2+1}$. It should be clear that as $x \rightarrow \pm\infty$, $\frac{2}{x^2+1} \approx$ very small (+), which means $r(x) \approx x^2 - 1 +$ very small (+). So the graph $y = r(x)$ is a little bit *above* the graph of the parabola $y = x^2 - 1$ as $x \rightarrow \pm\infty$. Graphically,

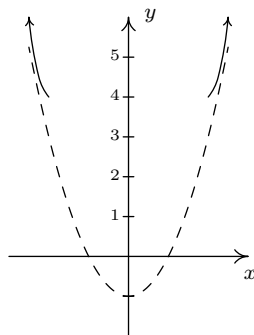

6. There isn't much work to do for a sign diagram for $r(x)$, since its domain is all real numbers and it has no zeros. Our sole test interval is $(-\infty, \infty)$, and since we know $r(0) = 1$, we conclude $r(x)$ is (+) for all real numbers. At this point, we don't have much to go on for

¹⁵This won't stop us from giving it the old community college try, however!

a graph.¹⁶ Below is a comparison of what we have determined analytically versus what the calculator shows us. We have no way to detect the relative extrema analytically¹⁷ apart from brute force plotting of points, which is done more efficiently by the calculator.

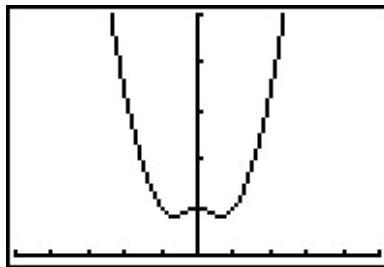
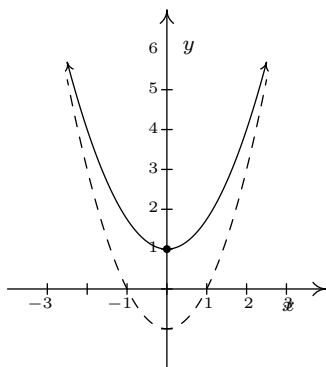

□

As usual, the authors offer no apologies for what may be construed as ‘pedantry’ in this section. We feel that the detail presented in this section is necessary to obtain a firm grasp of the concepts presented here and it also serves as an introduction to the methods employed in Calculus. As we have said many times in the past, your instructor will decide how much, if any, of the kinds of details presented here are ‘mission critical’ to your understanding of Precalculus. Without further delay, we present you with this section’s Exercises.

¹⁶So even Jeff at this point may check for symmetry! We leave it to the reader to show $r(-x) = r(x)$ so r is even, and, hence, its graph is symmetric about the y -axis.

¹⁷Without appealing to Calculus, of course.

4.2.1 EXERCISES

In Exercises 1 - 16, use the six-step procedure to graph the rational function. Be sure to draw any asymptotes as dashed lines.

1. $f(x) = \frac{4}{x+2}$

2. $f(x) = \frac{5x}{6-2x}$

3. $f(x) = \frac{1}{x^2}$

4. $f(x) = \frac{1}{x^2+x-12}$

5. $f(x) = \frac{2x-1}{-2x^2-5x+3}$

6. $f(x) = \frac{x}{x^2+x-12}$

7. $f(x) = \frac{4x}{x^2+4}$

8. $f(x) = \frac{4x}{x^2-4}$

9. $f(x) = \frac{x^2-x-12}{x^2+x-6}$

10. $f(x) = \frac{3x^2-5x-2}{x^2-9}$

11. $f(x) = \frac{x^2-x-6}{x+1}$

12. $f(x) = \frac{x^2-x}{3-x}$

13. $f(x) = \frac{x^3+2x^2+x}{x^2-x-2}$

14. $f(x) = \frac{-x^3+4x}{x^2-9}$

15. $f(x) = \frac{x^3-2x^2+3x}{2x^2+2}$

16.¹⁸ $f(x) = \frac{x^2-2x+1}{x^3+x^2-2x}$

In Exercises 17 - 20, graph the rational function by applying transformations to the graph of $y = \frac{1}{x}$.

17. $f(x) = \frac{1}{x-2}$

18. $g(x) = 1 - \frac{3}{x}$

19. $h(x) = \frac{-2x+1}{x}$ (Hint: Divide)

20. $j(x) = \frac{3x-7}{x-2}$ (Hint: Divide)

21. Discuss with your classmates how you would graph $f(x) = \frac{ax+b}{cx+d}$. What restrictions must be placed on a, b, c and d so that the graph is indeed a transformation of $y = \frac{1}{x}$?

22. In Example 3.1.1 in Section 3.1 we showed that $p(x) = \frac{4x+x^3}{x}$ is not a polynomial even though its formula reduced to $4+x^2$ for $x \neq 0$. However, it is a rational function similar to those studied in the section. With the help of your classmates, graph $p(x)$.

¹⁸Once you've done the six-step procedure, use your calculator to graph this function on the viewing window $[0, 12] \times [0, 0.25]$. What do you see?

23. Let $g(x) = \frac{x^4 - 8x^3 + 24x^2 - 72x + 135}{x^3 - 9x^2 + 15x - 7}$. With the help of your classmates, find the x - and y - intercepts of the graph of g . Find the intervals on which the function is increasing, the intervals on which it is decreasing and the local extrema. Find all of the asymptotes of the graph of g and any holes in the graph, if they exist. Be sure to show all of your work including any polynomial or synthetic division. Sketch the graph of g , using more than one picture if necessary to show all of the important features of the graph.

Example 4.2.4 showed us that the six-step procedure cannot tell us everything of importance about the graph of a rational function. Without Calculus, we need to use our graphing calculators to reveal the hidden mysteries of rational function behavior. Working with your classmates, use a graphing calculator to examine the graphs of the rational functions given in Exercises 24 - 27. Compare and contrast their features. Which features can the six-step process reveal and which features cannot be detected by it?

24. $f(x) = \frac{1}{x^2 + 1}$

25. $f(x) = \frac{x}{x^2 + 1}$

26. $f(x) = \frac{x^2}{x^2 + 1}$

27. $f(x) = \frac{x^3}{x^2 + 1}$

4.2.2 ANSWERS

1. $f(x) = \frac{4}{x+2}$

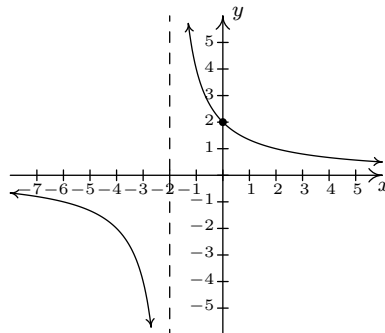
Domain: $(-\infty, -2) \cup (-2, \infty)$ No x -intercepts y -intercept: $(0, 2)$ Vertical asymptote: $x = -2$ As $x \rightarrow -2^-$, $f(x) \rightarrow -\infty$ As $x \rightarrow -2^+$, $f(x) \rightarrow \infty$ Horizontal asymptote: $y = 0$ As $x \rightarrow -\infty$, $f(x) \rightarrow 0^-$ As $x \rightarrow \infty$, $f(x) \rightarrow 0^+$ 

2. $f(x) = \frac{5x}{6-2x}$

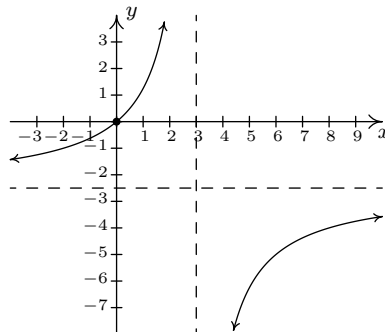
Domain: $(-\infty, 3) \cup (3, \infty)$ x -intercept: $(0, 0)$ y -intercept: $(0, 0)$ Vertical asymptote: $x = 3$ As $x \rightarrow 3^-$, $f(x) \rightarrow \infty$ As $x \rightarrow 3^+$, $f(x) \rightarrow -\infty$ Horizontal asymptote: $y = -\frac{5}{2}$ As $x \rightarrow -\infty$, $f(x) \rightarrow -\frac{5}{2}^+$ As $x \rightarrow \infty$, $f(x) \rightarrow -\frac{5}{2}^-$ 

3. $f(x) = \frac{1}{x^2}$

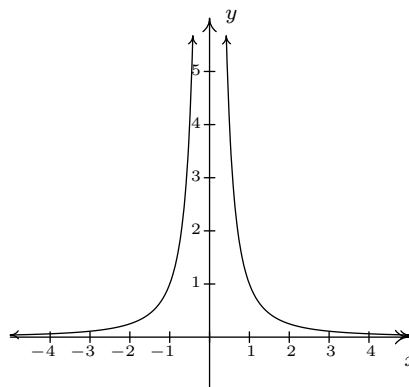
Domain: $(-\infty, 0) \cup (0, \infty)$ No x -interceptsNo y -interceptsVertical asymptote: $x = 0$ As $x \rightarrow 0^-$, $f(x) \rightarrow \infty$ As $x \rightarrow 0^+$, $f(x) \rightarrow \infty$ Horizontal asymptote: $y = 0$ As $x \rightarrow -\infty$, $f(x) \rightarrow 0^+$ As $x \rightarrow \infty$, $f(x) \rightarrow 0^+$ 

$$4. f(x) = \frac{1}{x^2 + x - 12} = \frac{1}{(x-3)(x+4)}$$

Domain: $(-\infty, -4) \cup (-4, 3) \cup (3, \infty)$

No x -intercepts

y -intercept: $(0, -\frac{1}{12})$

Vertical asymptotes: $x = -4$ and $x = 3$

As $x \rightarrow -4^-$, $f(x) \rightarrow \infty$

As $x \rightarrow -4^+$, $f(x) \rightarrow -\infty$

As $x \rightarrow 3^-$, $f(x) \rightarrow -\infty$

As $x \rightarrow 3^+$, $f(x) \rightarrow \infty$

Horizontal asymptote: $y = 0$

As $x \rightarrow -\infty$, $f(x) \rightarrow 0^+$

As $x \rightarrow \infty$, $f(x) \rightarrow 0^+$

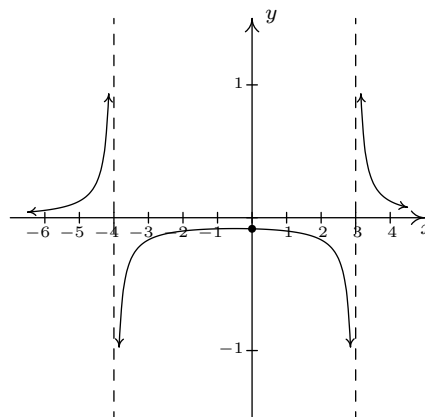

$$5. f(x) = \frac{2x-1}{-2x^2-5x+3} = -\frac{2x-1}{(2x-1)(x+3)}$$

Domain: $(-\infty, -3) \cup (-3, \frac{1}{2}) \cup (\frac{1}{2}, \infty)$

No x -intercepts

y -intercept: $(0, -\frac{1}{3})$

$f(x) = \frac{-1}{x+3}$, $x \neq \frac{1}{2}$

Hole in the graph at $(\frac{1}{2}, -\frac{2}{7})$

Vertical asymptote: $x = -3$

As $x \rightarrow -3^-$, $f(x) \rightarrow \infty$

As $x \rightarrow -3^+$, $f(x) \rightarrow -\infty$

Horizontal asymptote: $y = 0$

As $x \rightarrow -\infty$, $f(x) \rightarrow 0^+$

As $x \rightarrow \infty$, $f(x) \rightarrow 0^-$

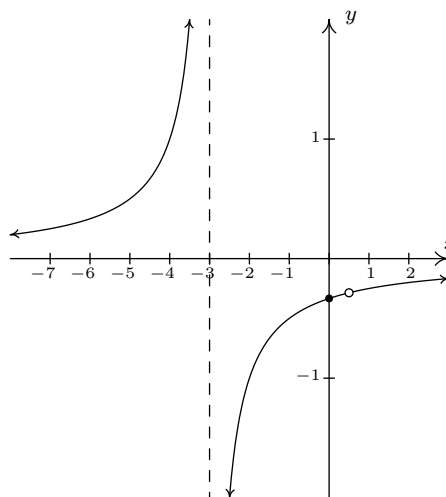

$$6. f(x) = \frac{x}{x^2 + x - 12} = \frac{x}{(x-3)(x+4)}$$

Domain: $(-\infty, -4) \cup (-4, 3) \cup (3, \infty)$

x -intercept: $(0, 0)$

y -intercept: $(0, 0)$

Vertical asymptotes: $x = -4$ and $x = 3$

As $x \rightarrow -4^-$, $f(x) \rightarrow -\infty$

As $x \rightarrow -4^+$, $f(x) \rightarrow \infty$

As $x \rightarrow 3^-$, $f(x) \rightarrow -\infty$

As $x \rightarrow 3^+$, $f(x) \rightarrow \infty$

Horizontal asymptote: $y = 0$

As $x \rightarrow -\infty$, $f(x) \rightarrow 0^-$

As $x \rightarrow \infty$, $f(x) \rightarrow 0^+$

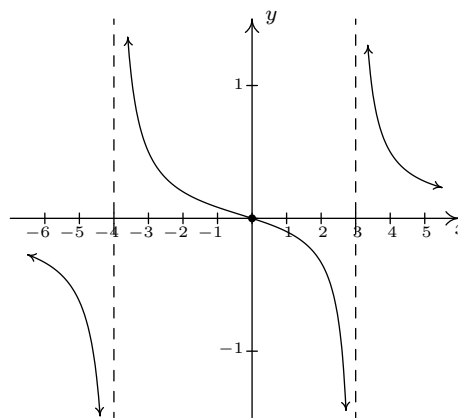

$$7. f(x) = \frac{4x}{x^2 + 4}$$

Domain: $(-\infty, \infty)$

x -intercept: $(0, 0)$

y -intercept: $(0, 0)$

No vertical asymptotes

No holes in the graph

Horizontal asymptote: $y = 0$

As $x \rightarrow -\infty, f(x) \rightarrow 0^-$

As $x \rightarrow \infty, f(x) \rightarrow 0^+$

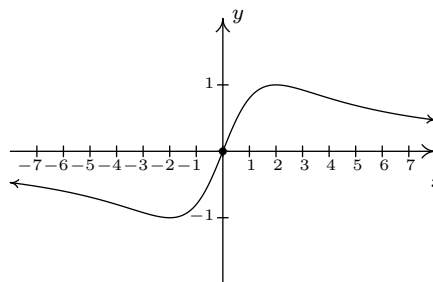

$$8. f(x) = \frac{4x}{x^2 - 4} = \frac{4x}{(x+2)(x-2)}$$

Domain: $(-\infty, -2) \cup (-2, 2) \cup (2, \infty)$

x -intercept: $(0, 0)$

y -intercept: $(0, 0)$

Vertical asymptotes: $x = -2, x = 2$

As $x \rightarrow -2^-, f(x) \rightarrow -\infty$

As $x \rightarrow -2^+, f(x) \rightarrow \infty$

As $x \rightarrow 2^-, f(x) \rightarrow -\infty$

As $x \rightarrow 2^+, f(x) \rightarrow \infty$

No holes in the graph

Horizontal asymptote: $y = 0$

As $x \rightarrow -\infty, f(x) \rightarrow 0^-$

As $x \rightarrow \infty, f(x) \rightarrow 0^+$

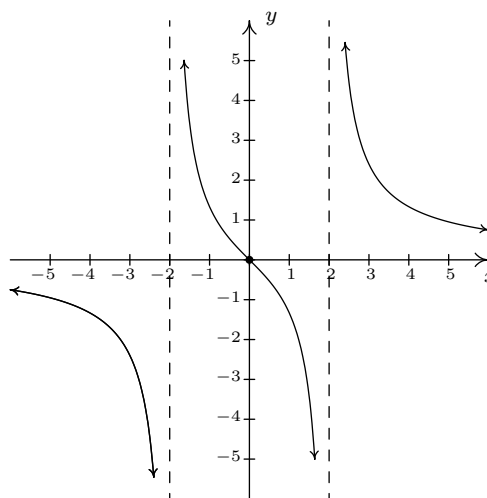

$$9. f(x) = \frac{x^2 - x - 12}{x^2 + x - 6} = \frac{x-4}{x-2}, x \neq -3$$

Domain: $(-\infty, -3) \cup (-3, 2) \cup (2, \infty)$

x -intercept: $(4, 0)$

y -intercept: $(0, 2)$

Vertical asymptote: $x = 2$

As $x \rightarrow 2^-, f(x) \rightarrow \infty$

As $x \rightarrow 2^+, f(x) \rightarrow -\infty$

Hole at $(-3, \frac{7}{5})$

Horizontal asymptote: $y = 1$

As $x \rightarrow -\infty, f(x) \rightarrow 1^+$

As $x \rightarrow \infty, f(x) \rightarrow 1^-$

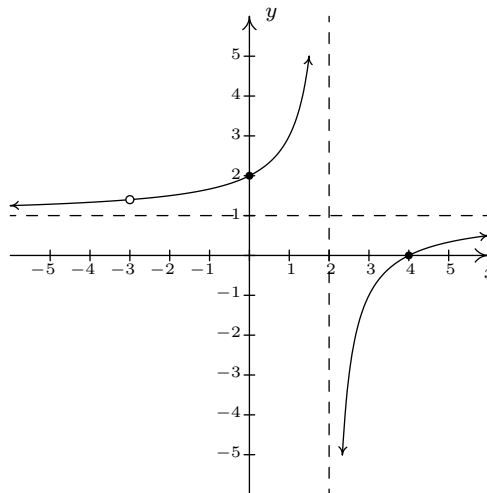

$$10. f(x) = \frac{3x^2 - 5x - 2}{x^2 - 9} = \frac{(3x+1)(x-2)}{(x+3)(x-3)}$$

Domain: $(-\infty, -3) \cup (-3, 3) \cup (3, \infty)$

x -intercepts: $(-\frac{1}{3}, 0), (2, 0)$

y -intercept: $(0, \frac{2}{9})$

Vertical asymptotes: $x = -3, x = 3$

As $x \rightarrow -3^-$, $f(x) \rightarrow \infty$

As $x \rightarrow -3^+$, $f(x) \rightarrow -\infty$

As $x \rightarrow 3^-$, $f(x) \rightarrow -\infty$

As $x \rightarrow 3^+$, $f(x) \rightarrow \infty$

No holes in the graph

Horizontal asymptote: $y = 3$

As $x \rightarrow -\infty$, $f(x) \rightarrow 3^+$

As $x \rightarrow \infty$, $f(x) \rightarrow 3^-$

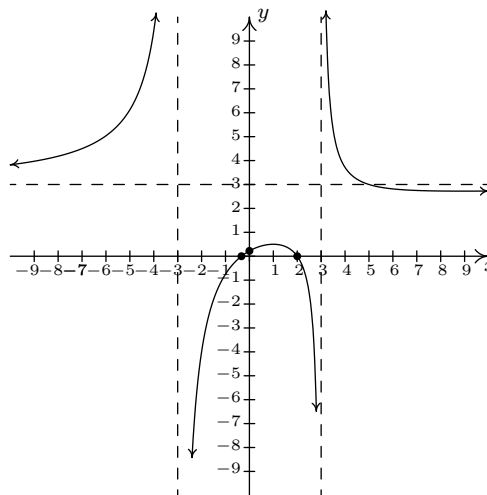

$$11. f(x) = \frac{x^2 - x - 6}{x + 1} = \frac{(x-3)(x+2)}{x+1}$$

Domain: $(-\infty, -1) \cup (-1, \infty)$

x -intercepts: $(-2, 0), (3, 0)$

y -intercept: $(0, -6)$

Vertical asymptote: $x = -1$

As $x \rightarrow -1^-$, $f(x) \rightarrow \infty$

As $x \rightarrow -1^+$, $f(x) \rightarrow -\infty$

Slant asymptote: $y = x - 2$

As $x \rightarrow -\infty$, the graph is above $y = x - 2$

As $x \rightarrow \infty$, the graph is below $y = x - 2$

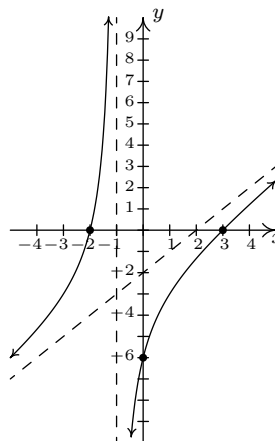

$$12. f(x) = \frac{x^2 - x}{3 - x} = \frac{x(x-1)}{3-x}$$

Domain: $(-\infty, 3) \cup (3, \infty)$

x -intercepts: $(0, 0), (1, 0)$

y -intercept: $(0, 0)$

Vertical asymptote: $x = 3$

As $x \rightarrow 3^-$, $f(x) \rightarrow \infty$

As $x \rightarrow 3^+$, $f(x) \rightarrow -\infty$

Slant asymptote: $y = -x - 2$

As $x \rightarrow -\infty$, the graph is above $y = -x - 2$

As $x \rightarrow \infty$, the graph is below $y = -x - 2$

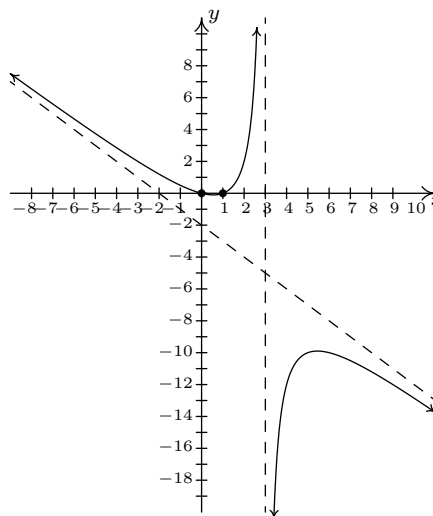

$$13. f(x) = \frac{x^3 + 2x^2 + x}{x^2 - x - 2} = \frac{x(x+1)}{x-2} \quad x \neq -1$$

Domain: $(-\infty, -1) \cup (-1, 2) \cup (2, \infty)$

x -intercept: $(0, 0)$

y -intercept: $(0, 0)$

Vertical asymptote: $x = 2$

As $x \rightarrow 2^-$, $f(x) \rightarrow -\infty$

As $x \rightarrow 2^+$, $f(x) \rightarrow \infty$

Hole at $(-1, 0)$

Slant asymptote: $y = x + 3$

As $x \rightarrow -\infty$, the graph is below $y = x + 3$

As $x \rightarrow \infty$, the graph is above $y = x + 3$

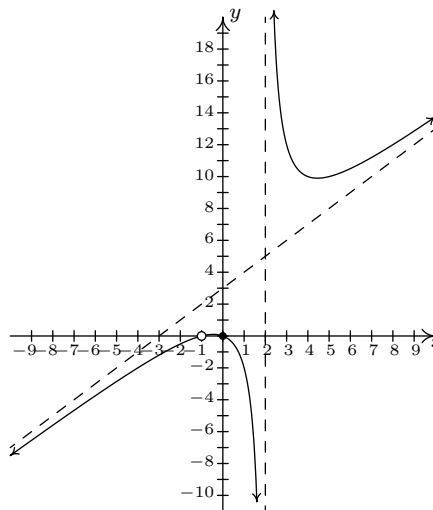

$$14. f(x) = \frac{-x^3 + 4x}{x^2 - 9}$$

Domain: $(-\infty, -3) \cup (-3, 3) \cup (3, \infty)$

x -intercepts: $(-2, 0), (0, 0), (2, 0)$

y -intercept: $(0, 0)$

Vertical asymptotes: $x = -3, x = 3$

As $x \rightarrow -3^-$, $f(x) \rightarrow \infty$

As $x \rightarrow -3^+$, $f(x) \rightarrow -\infty$

As $x \rightarrow 3^-$, $f(x) \rightarrow \infty$

As $x \rightarrow 3^+$, $f(x) \rightarrow -\infty$

Slant asymptote: $y = -x$

As $x \rightarrow -\infty$, the graph is above $y = -x$

As $x \rightarrow \infty$, the graph is below $y = -x$

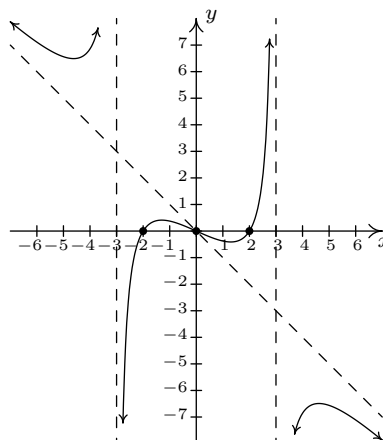

$$15. f(x) = \frac{x^3 - 2x^2 + 3x}{2x^2 + 2}$$

Domain: $(-\infty, \infty)$

x -intercept: $(0, 0)$

y -intercept: $(0, 0)$

Slant asymptote: $y = \frac{1}{2}x - 1$

As $x \rightarrow -\infty$, the graph is below $y = \frac{1}{2}x - 1$

As $x \rightarrow \infty$, the graph is above $y = \frac{1}{2}x - 1$

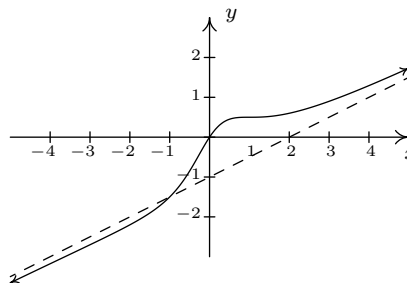

16. $f(x) = \frac{x^2 - 2x + 1}{x^3 + x^2 - 2x}$
 Domain: $(-\infty, -2) \cup (-2, 0) \cup (0, 1) \cup (1, \infty)$

$$f(x) = \frac{x-1}{x(x+2)}, x \neq 1$$

No x -intercepts

No y -intercepts

Vertical asymptotes: $x = -2$ and $x = 0$

As $x \rightarrow -2^-$, $f(x) \rightarrow -\infty$

As $x \rightarrow -2^+$, $f(x) \rightarrow \infty$

As $x \rightarrow 0^-$, $f(x) \rightarrow \infty$

As $x \rightarrow 0^+$, $f(x) \rightarrow -\infty$

Hole in the graph at $(1, 0)$

Horizontal asymptote: $y = 0$

As $x \rightarrow -\infty$, $f(x) \rightarrow 0^-$

As $x \rightarrow \infty$, $f(x) \rightarrow 0^+$

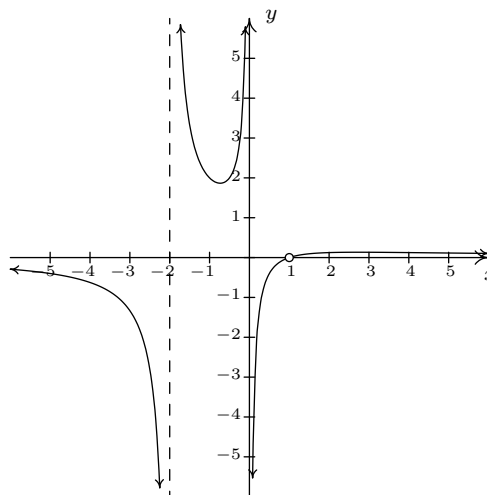

17. $f(x) = \frac{1}{x-2}$

Shift the graph of $y = \frac{1}{x}$
 to the right 2 units.

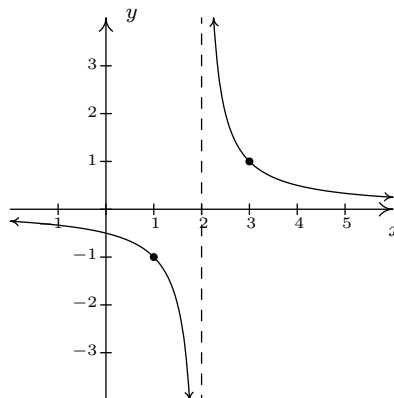

18. $g(x) = 1 - \frac{3}{x}$

Vertically stretch the graph of $y = \frac{1}{x}$
 by a factor of 3.

Reflect the graph of $y = \frac{3}{x}$
 about the x -axis.

Shift the graph of $y = -\frac{3}{x}$
 up 1 unit.

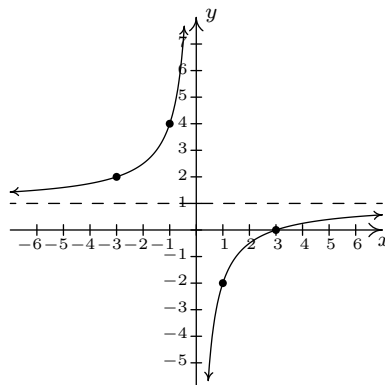

19. $h(x) = \frac{-2x + 1}{x} = -2 + \frac{1}{x}$

Shift the graph of $y = \frac{1}{x}$
down 2 units.

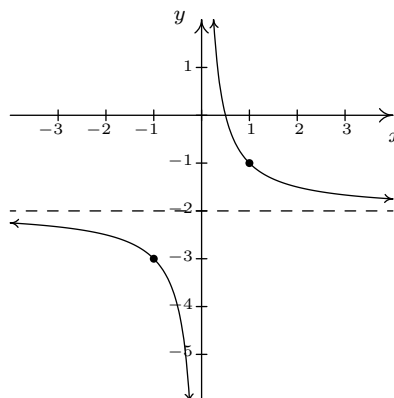

20. $j(x) = \frac{3x - 7}{x - 2} = 3 - \frac{1}{x - 2}$

Shift the graph of $y = \frac{1}{x}$
to the right 2 units.

Reflect the graph of $y = \frac{1}{x - 2}$
about the x -axis.

Shift the graph of $y = -\frac{1}{x - 2}$
up 3 units.

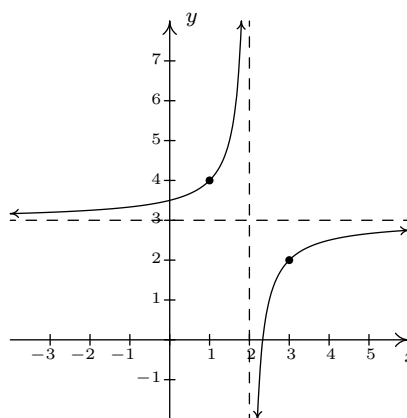

4.3 RATIONAL INEQUALITIES AND APPLICATIONS

In this section, we solve equations and inequalities involving rational functions and explore associated application problems. Our first example showcases the critical difference in procedure between solving a rational equation and a rational inequality.

Example 4.3.1.

1. Solve $\frac{x^3 - 2x + 1}{x - 1} = \frac{1}{2}x - 1$.
2. Solve $\frac{x^3 - 2x + 1}{x - 1} \geq \frac{1}{2}x - 1$.
3. Use your calculator to graphically check your answers to 1 and 2.

Solution.

1. To solve the equation, we clear denominators

$$\begin{aligned} \frac{x^3 - 2x + 1}{x - 1} &= \frac{1}{2}x - 1 \\ \left(\frac{x^3 - 2x + 1}{x - 1}\right) \cdot 2(x - 1) &= \left(\frac{1}{2}x - 1\right) \cdot 2(x - 1) \\ 2x^3 - 4x + 2 &= x^2 - 3x + 2 && \text{expand} \\ 2x^3 - x^2 - x &= 0 \\ x(2x + 1)(x - 1) &= 0 && \text{factor} \\ x &= -\frac{1}{2}, 0, 1 \end{aligned}$$

Since we cleared denominators, we need to check for extraneous solutions. Sure enough, we see that $x = 1$ does not satisfy the original equation and must be discarded. Our solutions are $x = -\frac{1}{2}$ and $x = 0$.

2. To solve the inequality, it may be tempting to begin as we did with the equation – namely by multiplying both sides by the quantity $(x - 1)$. The problem is that, depending on x , $(x - 1)$ may be positive (which doesn't affect the inequality) or $(x - 1)$ could be negative (which would reverse the inequality). Instead of working by cases, we collect all of the terms on one side of the inequality with 0 on the other and make a sign diagram using the technique given on page 455 in Section 4.2.

$$\begin{aligned} \frac{x^3 - 2x + 1}{x - 1} &\geq \frac{1}{2}x - 1 \\ \frac{x^3 - 2x + 1}{x - 1} - \frac{1}{2}x + 1 &\geq 0 \\ \frac{2(x^3 - 2x + 1) - x(x - 1) + 1(2(x - 1))}{2(x - 1)} &\geq 0 && \text{get a common denominator} \\ \frac{2x^3 - x^2 - x}{2x - 2} &\geq 0 && \text{expand} \end{aligned}$$

Viewing the left hand side as a rational function $r(x)$ we make a sign diagram. The only value excluded from the domain of r is $x = 1$ which is the solution to $2x - 2 = 0$. The zeros of r are the solutions to $2x^3 - x^2 - x = 0$, which we have already found to be $x = 0$, $x = -\frac{1}{2}$ and $x = 1$, the latter was discounted as a zero because it is not in the domain. Choosing test values in each test interval, we construct the sign diagram below.

$$\begin{array}{ccccccc} & (+) & 0 & (-) & 0 & (+) & \text{?} & (+) \\ & \leftarrow & & & & & & \rightarrow \\ & & -\frac{1}{2} & & 0 & & 1 & \end{array}$$

We are interested in where $r(x) \geq 0$. We find $r(x) > 0$, or (+), on the intervals $(-\infty, -\frac{1}{2})$, $(0, 1)$ and $(1, \infty)$. We add to these intervals the zeros of r , $-\frac{1}{2}$ and 0 , to get our final solution: $(-\infty, -\frac{1}{2}] \cup [0, 1) \cup (1, \infty)$.

3. Geometrically, if we set $f(x) = \frac{x^3 - 2x + 1}{x - 1}$ and $g(x) = \frac{1}{2}x - 1$, the solutions to $f(x) = g(x)$ are the x -coordinates of the points where the graphs of $y = f(x)$ and $y = g(x)$ intersect. The solution to $f(x) \geq g(x)$ represents not only where the graphs meet, but the intervals over which the graph of $y = f(x)$ is above ($>$) the graph of $g(x)$. We obtain the graphs below.



The ‘Intersect’ command confirms that the graphs cross when $x = -\frac{1}{2}$ and $x = 0$. It is clear from the calculator that the graph of $y = f(x)$ is above the graph of $y = g(x)$ on $(-\infty, -\frac{1}{2})$ as well as on $(0, \infty)$. According to the calculator, our solution is then $(-\infty, -\frac{1}{2}] \cup [0, \infty)$ which *almost* matches the answer we found analytically. We have to remember that f is not defined at $x = 1$, and, even though it isn’t shown on the calculator, there is a hole¹ in the graph of $y = f(x)$ when $x = 1$ which is why $x = 1$ is not part of our final answer. \square

Next, we explore how rational equations can be used to solve some classic problems involving rates.

Example 4.3.2. Carl decides to explore the Meander River, the location of several recent Sasquatch sightings. From camp, he canoes downstream five miles to check out a purported Sasquatch nest. Finding nothing, he immediately turns around, retraces his route (this time traveling upstream),

¹There is no asymptote at $x = 1$ since the graph is well behaved near $x = 1$. According to Theorem 4.1, there must be a hole there.

and returns to camp 3 hours after he left. If Carl canoes at a rate of 6 miles per hour in still water, how fast was the Meander River flowing on that day?

Solution. We are given information about distances, rates (speeds) and times. The basic principle relating these quantities is:

$$\text{distance} = \text{rate} \cdot \text{time}$$

The first observation to make, however, is that the distance, rate and time given to us aren't 'compatible': the distance given is the distance for only *part* of the trip, the rate given is the speed Carl can canoe in still water, not in a flowing river, and the time given is the duration of the *entire* trip. Ultimately, we are after the speed of the river, so let's call that R measured in miles per hour to be consistent with the other rate given to us. To get started, let's divide the trip into its two parts: the initial trip downstream and the return trip upstream. For the downstream trip, all we know is that the distance traveled is 5 miles.

$$\begin{aligned} \text{distance downstream} &= \text{rate traveling downstream} \cdot \text{time traveling downstream} \\ 5 \text{ miles} &= \text{rate traveling downstream} \cdot \text{time traveling downstream} \end{aligned}$$

Since the return trip upstream followed the same route as the trip downstream, we know that the distance traveled upstream is also 5 miles.

$$\begin{aligned} \text{distance upstream} &= \text{rate traveling upstream} \cdot \text{time traveling upstream} \\ 5 \text{ miles} &= \text{rate traveling upstream} \cdot \text{time traveling upstream} \end{aligned}$$

We are told Carl can canoe at a rate of 6 miles per hour in still water. How does this figure into the rates traveling upstream and downstream? The speed the canoe travels in the river is a combination of the speed at which Carl can propel the canoe in still water, 6 miles per hour, and the speed of the river, which we're calling R . When traveling downstream, the river is helping Carl along, so we *add* these two speeds:

$$\begin{aligned} \text{rate traveling downstream} &= \text{rate Carl propels the canoe} + \text{speed of the river} \\ &= 6 \frac{\text{miles}}{\text{hour}} + R \frac{\text{miles}}{\text{hour}} \end{aligned}$$

So our downstream speed is $(6 + R) \frac{\text{miles}}{\text{hour}}$. Substituting this into our 'distance-rate-time' equation for the downstream part of the trip, we get:

$$\begin{aligned} 5 \text{ miles} &= \text{rate traveling downstream} \cdot \text{time traveling downstream} \\ 5 \text{ miles} &= (6 + R) \frac{\text{miles}}{\text{hour}} \cdot \text{time traveling downstream} \end{aligned}$$

When traveling upstream, Carl works against the current. Since the canoe manages to travel upstream, the speed Carl can canoe in still water is greater than the river's speed, so we *subtract* the river's speed *from* Carl's canoeing speed to get:

$$\begin{aligned} \text{rate traveling upstream} &= \text{rate Carl propels the canoe} - \text{river speed} \\ &= 6 \frac{\text{miles}}{\text{hour}} - R \frac{\text{miles}}{\text{hour}} \end{aligned}$$

Proceeding as before, we get

$$\begin{aligned} 5 \text{ miles} &= \text{rate traveling upstream} \cdot \text{time traveling upstream} \\ 5 \text{ miles} &= (6 - R) \frac{\text{miles}}{\text{hour}} \cdot \text{time traveling upstream} \end{aligned}$$

The last piece of information given to us is that the total trip lasted 3 hours. If we let t_{down} denote the time of the downstream trip and t_{up} the time of the upstream trip, we have: $t_{\text{down}} + t_{\text{up}} = 3$ hours. Substituting t_{down} and t_{up} into the ‘distance-rate-time’ equations, we get (suppressing the units) *three* equations in *three* unknowns:²

$$\begin{cases} E1 & (6 + R)t_{\text{down}} = 5 \\ E2 & (6 - R)t_{\text{up}} = 5 \\ E3 & t_{\text{down}} + t_{\text{up}} = 3 \end{cases}$$

Since we are ultimately after R , we need to use these three equations to get at least one equation involving only R . To that end, we solve *E1* for t_{down} by dividing both sides³ by the quantity $(6 + R)$ to get $t_{\text{down}} = \frac{5}{6+R}$. Similarly, we solve *E2* for t_{up} and get $t_{\text{up}} = \frac{5}{6-R}$. Substituting these into *E3*, we get:⁴

$$\frac{5}{6+R} + \frac{5}{6-R} = 3.$$

Clearing denominators, we get $5(6 - R) + 5(6 + R) = 3(6 + R)(6 - R)$ which reduces to $R^2 = 16$. We find $R = \pm 4$, and since R represents the speed of the river, we choose $R = 4$. On the day in question, the Meander River is flowing at a rate of 4 miles per hour. \square

One of the important lessons to learn from Example 4.3.2 is that speeds, and more generally, rates, are additive. As we see in our next example, the concept of rate and its associated principles can be applied to a wide variety of problems - not just ‘distance-rate-time’ scenarios.

Example 4.3.3. Working alone, Taylor can weed the garden in 4 hours. If Carl helps, they can weed the garden in 3 hours. How long would it take for Carl to weed the garden on his own?

Solution. The key relationship between work and time which we use in this problem is:

$$\text{amount of work done} = \text{rate of work} \cdot \text{time spent working}$$

We are told that, working alone, Taylor can weed the garden in 4 hours. In Taylor’s case then:

$$\begin{aligned} \text{amount of work Taylor does} &= \text{rate of Taylor working} \cdot \text{time Taylor spent working} \\ 1 \text{ garden} &= (\text{rate of Taylor working}) \cdot (4 \text{ hours}) \end{aligned}$$

So we have that the rate Taylor works is $\frac{1 \text{ garden}}{4 \text{ hours}} = \frac{1}{4} \frac{\text{garden}}{\text{hour}}$. We are also told that when working together, Taylor and Carl can weed the garden in just 3 hours. We have:

²This is called a *system* of equations. No doubt, you’ve had experience with these things before, and we will study systems in greater detail in Chapter 7.

³While we usually discourage dividing both sides of an equation by a variable expression, we know $(6 + R) \neq 0$ since otherwise we couldn’t possibly multiply it by t_{down} and get 5.

⁴The reader is encouraged to verify that the units in this equation are the same on both sides. To get you started, the units on the ‘3’ is ‘hours.’

$$\begin{aligned}\text{amount of work done together} &= \text{rate of working together} \cdot \text{time spent working together} \\ 1 \text{ garden} &= (\text{rate of working together}) \cdot (3 \text{ hours})\end{aligned}$$

From this, we find that the rate of Taylor and Carl working together is $\frac{1 \text{ garden}}{3 \text{ hours}} = \frac{1}{3} \frac{\text{garden}}{\text{hour}}$. We are asked to find out how long it would take for Carl to weed the garden on his own. Let us call this unknown t , measured in hours to be consistent with the other times given to us in the problem. Then:

$$\begin{aligned}\text{amount of work Carl does} &= \text{rate of Carl working} \cdot \text{time Carl spent working} \\ 1 \text{ garden} &= (\text{rate of Carl working}) \cdot (t \text{ hours})\end{aligned}$$

In order to find t , we need to find the rate of Carl working, so let's call this quantity R , with units $\frac{\text{garden}}{\text{hour}}$. Using the fact that rates are additive, we have:

$$\begin{aligned}\text{rate working together} &= \text{rate of Taylor working} + \text{rate of Carl working} \\ \frac{1}{3} \frac{\text{garden}}{\text{hour}} &= \frac{1}{4} \frac{\text{garden}}{\text{hour}} + R \frac{\text{garden}}{\text{hour}}\end{aligned}$$

so that $R = \frac{1}{12} \frac{\text{garden}}{\text{hour}}$. Substituting this into our 'work-rate-time' equation for Carl, we get:

$$\begin{aligned}1 \text{ garden} &= (\text{rate of Carl working}) \cdot (t \text{ hours}) \\ 1 \text{ garden} &= \left(\frac{1}{12} \frac{\text{garden}}{\text{hour}} \right) \cdot (t \text{ hours})\end{aligned}$$

Solving $1 = \frac{1}{12}t$, we get $t = 12$, so it takes Carl 12 hours to weed the garden on his own.⁵ \square

As is common with 'word problems' like Examples 4.3.2 and 4.3.3, there is no short-cut to the answer. We encourage the reader to carefully think through and apply the basic principles of rate to each (potentially different!) situation. It is time well spent. We also encourage the tracking of units, especially in the early stages of the problem. Not only does this promote uniformity in the units, it also serves as a quick means to check if an equation makes sense.⁶

Our next example deals with the average cost function, first introduced on page 216, as applied to PortaBoy Game systems from Example 2.1.5 in Section 2.1.

Example 4.3.4. Given a cost function $C(x)$, which returns the total cost of producing x items, recall that the average cost function, $\bar{C}(x) = \frac{C(x)}{x}$ computes the cost per item when x items are produced. Suppose the cost C , in dollars, to produce x PortaBoy game systems for a local retailer is $C(x) = 80x + 150$, $x \geq 0$.

1. Find an expression for the average cost function $\bar{C}(x)$.
2. Solve $\bar{C}(x) < 100$ and interpret.

⁵Carl would much rather spend his time writing open-source Mathematics texts than gardening anyway.

⁶In other words, make sure you don't try to add apples to oranges!

3. Determine the behavior of $\overline{C}(x)$ as $x \rightarrow \infty$ and interpret.

Solution.

1. From $\overline{C}(x) = \frac{C(x)}{x}$, we obtain $\overline{C}(x) = \frac{80x+150}{x}$. The domain of C is $x \geq 0$, but since $x = 0$ causes problems for $\overline{C}(x)$, we get our domain to be $x > 0$, or $(0, \infty)$.
2. Solving $\overline{C}(x) < 100$ means we solve $\frac{80x+150}{x} < 100$. We proceed as in the previous example.

$$\begin{aligned} \frac{80x + 150}{x} &< 100 \\ \frac{80x + 150}{x} - 100 &< 0 \\ \frac{80x + 150 - 100x}{x} &< 0 \quad \text{common denominator} \\ \frac{150 - 20x}{x} &< 0 \end{aligned}$$

If we take the left hand side to be a rational function $r(x)$, we need to keep in mind that the applied domain of the problem is $x > 0$. This means we consider only the positive half of the number line for our sign diagram. On $(0, \infty)$, r is defined everywhere so we need only look for zeros of r . Setting $r(x) = 0$ gives $150 - 20x = 0$, so that $x = \frac{15}{2} = 7.5$. The test intervals on our domain are $(0, 7.5)$ and $(7.5, \infty)$. We find $r(x) < 0$ on $(7.5, \infty)$.

$$\begin{array}{c} \text{?} \quad (+) \quad 0 \quad (-) \\ \hline 0 \qquad \qquad 7.5 \end{array}$$

In the context of the problem, x represents the number of PortaBoy games systems produced and $\overline{C}(x)$ is the average cost to produce each system. Solving $\overline{C}(x) < 100$ means we are trying to find how many systems we need to produce so that the average cost is less than \$100 per system. Our solution, $(7.5, \infty)$ tells us that we need to produce more than 7.5 systems to achieve this. Since it doesn't make sense to produce half a system, our final answer is $[8, \infty)$.

3. When we apply Theorem 4.2 to $\overline{C}(x)$ we find that $y = 80$ is a horizontal asymptote to the graph of $y = \overline{C}(x)$. To more precisely determine the behavior of $\overline{C}(x)$ as $x \rightarrow \infty$, we first use long division⁷ and rewrite $\overline{C}(x) = 80 + \frac{150}{x}$. As $x \rightarrow \infty$, $\frac{150}{x} \rightarrow 0^+$, which means $\overline{C}(x) \approx 80 + \text{very small } (+)$. Thus the average cost per system is getting closer to \$80 per system. If we set $\overline{C}(x) = 80$, we get $\frac{150}{x} = 0$, which is impossible, so we conclude that $\overline{C}(x) > 80$ for all $x > 0$. This means that the average cost per system is always greater than \$80 per system, but the average cost is approaching this amount as more and more systems are produced. Looking back at Example 2.1.5, we realize \$80 is the variable cost per system –

⁷In this case, long division amounts to term-by-term division.

the cost per system above and beyond the fixed initial cost of \$150. Another way to interpret our answer is that ‘infinitely’ many systems would need to be produced to effectively ‘zero out’ the fixed cost. \square

Our next example is another classic ‘box with no top’ problem.

Example 4.3.5. A box with a square base and no top is to be constructed so that it has a volume of 1000 cubic centimeters. Let x denote the width of the box, in centimeters as seen below.

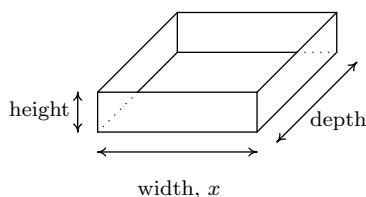

1. Express the height h in centimeters as a function of the width x and state the applied domain.
2. Solve $h(x) \geq x$ and interpret.
3. Find and interpret the behavior of $h(x)$ as $x \rightarrow 0^+$ and as $x \rightarrow \infty$.
4. Express the surface area S of the box as a function of x and state the applied domain.
5. Use a calculator to approximate (to two decimal places) the dimensions of the box which minimize the surface area.

Solution.

1. We are told that the volume of the box is 1000 cubic centimeters and that x represents the width, in centimeters. From geometry, we know $\text{Volume} = \text{width} \times \text{height} \times \text{depth}$. Since the base of the box is a square, the width and the depth are both x centimeters. Using h for the height, we have $1000 = x^2h$, so that $h = \frac{1000}{x^2}$. Using function notation,⁸ $h(x) = \frac{1000}{x^2}$. As for the applied domain, in order for there to be a box at all, $x > 0$, and since every such choice of x will return a positive number for the height h we have no other restrictions and conclude our domain is $(0, \infty)$.
2. To solve $h(x) \geq x$, we proceed as before and collect all nonzero terms on one side of the inequality in order to use a sign diagram.

⁸That is, $h(x)$ means ‘ h of x ’, not ‘ h times x ’ here.

$$\begin{aligned}
 h(x) &\geq x \\
 \frac{1000}{x^2} &\geq x \\
 \frac{1000}{x^2} - x &\geq 0 \\
 \frac{1000 - x^3}{x^2} &\geq 0 \quad \text{common denominator}
 \end{aligned}$$

We consider the left hand side of the inequality as our rational function $r(x)$. We see r is undefined at $x = 0$, but, as in the previous example, the applied domain of the problem is $x > 0$, so we are considering only the behavior of r on $(0, \infty)$. The sole zero of r comes when $1000 - x^3 = 0$, which is $x = 10$. Choosing test values in the intervals $(0, 10)$ and $(10, \infty)$ gives the following diagram.

$$\begin{array}{c}
 \text{? } (+) \quad 0 \quad (-) \\
 \hline
 0 \qquad \qquad 10 \qquad \rightarrow
 \end{array}$$

We see $r(x) > 0$ on $(0, 10)$, and since $r(x) = 0$ at $x = 10$, our solution is $(0, 10]$. In the context of the problem, h represents the height of the box while x represents the width (and depth) of the box. Solving $h(x) \geq x$ is tantamount to finding the values of x which result in a box where the height is at least as big as the width (and, in this case, depth.) Our answer tells us the width of the box can be at most 10 centimeters for this to happen.

- As $x \rightarrow 0^+$, $h(x) = \frac{1000}{x^2} \rightarrow \infty$. This means that the smaller the width x (and, in this case, depth), the larger the height h has to be in order to maintain a volume of 1000 cubic centimeters. As $x \rightarrow \infty$, we find $h(x) \rightarrow 0^+$, which means that in order to maintain a volume of 1000 cubic centimeters, the width and depth must get bigger as the height becomes smaller.
- Since the box has no top, the surface area can be found by adding the area of each of the sides to the area of the base. The base is a square of dimensions x by x , and each side has dimensions x by h . We get the surface area, $S = x^2 + 4xh$. To get S as a function of x , we substitute $h = \frac{1000}{x^2}$ to obtain $S = x^2 + 4x\left(\frac{1000}{x^2}\right)$. Hence, as a function of x , $S(x) = x^2 + \frac{4000}{x}$. The domain of S is the same as h , namely $(0, \infty)$, for the same reasons as above.
- A first attempt at the graph of $y = S(x)$ on the calculator may lead to frustration. Chances are good that the first window chosen to view the graph will suggest $y = S(x)$ has the x -axis as a horizontal asymptote. From the formula $S(x) = x^2 + \frac{4000}{x}$, however, we get $S(x) \approx x^2$ as $x \rightarrow \infty$, so $S(x) \rightarrow \infty$. Readjusting the window, we find S does possess a relative minimum at $x \approx 12.60$. As far as we can tell,⁹ this is the only relative extremum, so it is the absolute minimum as well. This means that the width and depth of the box should each measure

⁹without Calculus, that is...

approximately 12.60 centimeters. To determine the height, we find $h(12.60) \approx 6.30$, so the height of the box should be approximately 6.30 centimeters.

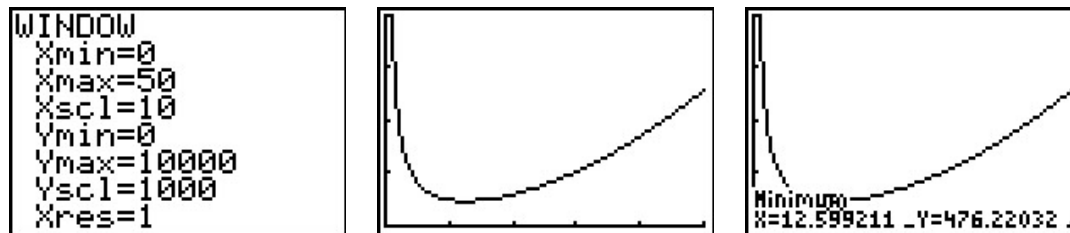

□

4.3.1 VARIATION

In many instances in the sciences, rational functions are encountered as a result of fundamental natural laws which are typically a result of assuming certain basic relationships between variables. These basic relationships are summarized in the definition below.

Definition 4.5. Suppose x , y and z are variable quantities. We say

- y **varies directly with** (or is **directly proportional to**) x if there is a constant k such that $y = kx$.
- y **varies inversely with** (or is **inversely proportional to**) x if there is a constant k such that $y = \frac{k}{x}$.
- z **varies jointly with** (or is **jointly proportional to**) x and y if there is a constant k such that $z = kxy$.

The constant k in the above definitions is called the **constant of proportionality**.

Example 4.3.6. Translate the following into mathematical equations using Definition 4.5.

1. [Hooke's Law](#): The force F exerted on a spring is directly proportional the extension x of the spring.
2. [Boyle's Law](#): At a constant temperature, the pressure P of an ideal gas is inversely proportional to its volume V .
3. The volume V of a right circular cone varies jointly with the height h of the cone and the square of the radius r of the base.
4. [Ohm's Law](#): The current I through a conductor between two points is directly proportional to the voltage V between the two points and inversely proportional to the resistance R between the two points.

5. [Newton's Law of Universal Gravitation](#): Suppose two objects, one of mass m and one of mass M , are positioned so that the distance between their centers of mass is r . The gravitational force F exerted on the two objects varies directly with the product of the two masses and inversely with the square of the distance between their centers of mass.

Solution.

1. Applying the definition of direct variation, we get $F = kx$ for some constant k .
2. Since P and V are inversely proportional, we write $P = \frac{k}{V}$.
3. There is a bit of ambiguity here. It's clear that the volume and the height of the cone are represented by the quantities V and h , respectively, but does r represent the radius of the base or the square of the radius of the base? It is the former. Usually, if an algebraic operation is specified (like squaring), it is meant to be expressed in the formula. We apply Definition 4.5 to get $V = khr^2$.
4. Even though the problem doesn't use the phrase 'varies jointly', it is implied by the fact that the current I is related to two different quantities. Since I varies directly with V but inversely with R , we write $I = \frac{kV}{R}$.
5. We write the product of the masses mM and the square of the distance as r^2 . We have that F varies directly with mM and inversely with r^2 , so $F = \frac{kmM}{r^2}$. \square

In many of the formulas in the previous example, more than two varying quantities are related. In practice, however, usually all but two quantities are held constant in an experiment and the data collected is used to relate just two of the variables. Comparing just two varying quantities allows us to view the relationship between them as functional, as the next example illustrates.

Example 4.3.7. According to this [website](#) the actual data relating the volume V of a gas and its pressure P used by Boyle and his assistant in 1662 to verify the gas law that bears his name is given below.

V	48	46	44	42	40	38	36	34	32	30	28	26	24
P	29.13	30.56	31.94	33.5	35.31	37	39.31	41.63	44.19	47.06	50.31	54.31	58.81

V	23	22	21	20	19	18	17	16	15	14	13	12
P	61.31	64.06	67.06	70.69	74.13	77.88	82.75	87.88	93.06	100.44	107.81	117.56

1. Use your calculator to generate a scatter diagram for these data using V as the independent variable and P as the dependent variable. Does it appear from the graph that P is inversely proportional to V ? Explain.
2. Assuming that P and V do vary inversely, use the data to approximate the constant of proportionality.

3. Use your calculator to determine a ‘Power Regression’ for this data¹⁰ and use it to verify your results in 1 and 2.

Solution.

1. If P really does vary inversely with V , then $P = \frac{k}{V}$ for some constant k . From the data plot, the points do seem to lie along a curve like $y = \frac{k}{x}$.
2. To determine the constant of proportionality, we note that from $P = \frac{k}{V}$, we get $k = PV$. Multiplying each of the volume numbers times each of the pressure numbers,¹¹ we produce a number which is always approximately 1400. We suspect that $P = \frac{1400}{V}$. Graphing $y = \frac{1400}{x}$ along with the data gives us good reason to believe our hypotheses that P and V are, in fact, inversely related.

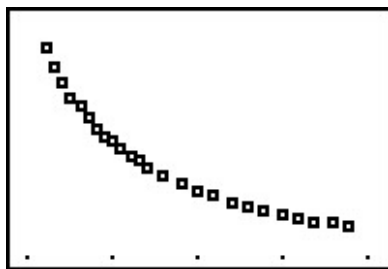

The graph of the data

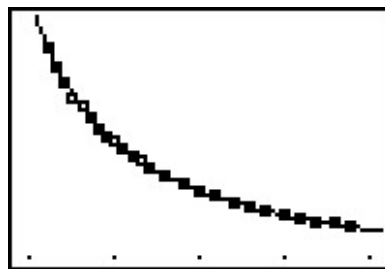

The data with $y = \frac{1400}{x}$

3. After performing a ‘Power Regression’, the calculator fits the data to the curve $y = ax^b$ where $a \approx 1400$ and $b \approx -1$ with a correlation coefficient which is darned near perfect.¹² In other words, $y = 1400x^{-1}$ or $y = \frac{1400}{x}$, as we guessed.

```

PwrReg
y=a*x^b
a=1400.874407
b=-.9984033692
r^2=.9999320488
r=-.9999660238

```

□

¹⁰We will talk more about this in the coming chapters.

¹¹You can use tell the calculator to do this arithmetic on the lists and save yourself some time.

¹²We will revisit this example once we have developed logarithms in Chapter 6 to see how we can actually ‘linearize’ this data and do a linear regression to obtain the same result.

4.3.2 EXERCISES

In Exercises 1 - 6, solve the rational equation. Be sure to check for extraneous solutions.

1. $\frac{x}{5x+4} = 3$

2. $\frac{3x-1}{x^2+1} = 1$

3. $\frac{1}{x+3} + \frac{1}{x-3} = \frac{x^2-3}{x^2-9}$

4. $\frac{2x+17}{x+1} = x+5$

5. $\frac{x^2-2x+1}{x^3+x^2-2x} = 1$

6. $\frac{-x^3+4x}{x^2-9} = 4x$

In Exercises 7 - 20, solve the rational inequality. Express your answer using interval notation.

7. $\frac{1}{x+2} \geq 0$

8. $\frac{x-3}{x+2} \leq 0$

9. $\frac{x}{x^2-1} > 0$

10. $\frac{4x}{x^2+4} \geq 0$

11. $\frac{x^2-x-12}{x^2+x-6} > 0$

12. $\frac{3x^2-5x-2}{x^2-9} < 0$

13. $\frac{x^3+2x^2+x}{x^2-x-2} \geq 0$

14. $\frac{x^2+5x+6}{x^2-1} > 0$

15. $\frac{3x-1}{x^2+1} \leq 1$

16. $\frac{2x+17}{x+1} > x+5$

17. $\frac{-x^3+4x}{x^2-9} \geq 4x$

18. $\frac{1}{x^2+1} < 0$

19. $\frac{x^4-4x^3+x^2-2x-15}{x^3-4x^2} \geq x$

20. $\frac{5x^3-12x^2+9x+10}{x^2-1} \geq 3x-1$

21. Carl and Mike start a 3 mile race at the same time. If Mike ran the race at 6 miles per hour and finishes the race 10 minutes before Carl, how fast does Carl run?
22. One day, Donnie observes that the wind is blowing at 6 miles per hour. A unladen swallow nesting near Donnie's house flies three quarters of a mile down the road (in the direction of the wind), turns around, and returns exactly 4 minutes later. What is the airspeed of the unladen swallow? (Here, 'airspeed' is the speed that the swallow can fly in still air.)
23. In order to remove water from a flooded basement, two pumps, each rated at 40 gallons per minute, are used. After half an hour, the one pump burns out, and the second pump finishes removing the water half an hour later. How many gallons of water were removed from the basement?
24. A faucet can fill a sink in 5 minutes while a drain will empty the same sink in 8 minutes. If the faucet is turned on and the drain is left open, how long will it take to fill the sink?
25. Working together, Daniel and Donnie can clean the llama pen in 45 minutes. On his own, Daniel can clean the pen in an hour. How long does it take Donnie to clean the llama pen on his own?

26. In Exercise 32, the function $C(x) = .03x^3 - 4.5x^2 + 225x + 250$, for $x \geq 0$ was used to model the cost (in dollars) to produce x PortaBoy game systems. Using this cost function, find the number of PortaBoys which should be produced to minimize the average cost \bar{C} . Round your answer to the nearest number of systems.
27. Suppose we are in the same situation as Example 4.3.5. If the volume of the box is to be 500 cubic centimeters, use your calculator to find the dimensions of the box which minimize the surface area. What is the minimum surface area? Round your answers to two decimal places.
28. The box for the new Sasquatch-themed cereal, ‘Crypt-Os’, is to have a volume of 140 cubic inches. For aesthetic reasons, the height of the box needs to be 1.62 times the width of the base of the box.¹³ Find the dimensions of the box which will minimize the surface area of the box. What is the minimum surface area? Round your answers to two decimal places.
29. Sally is Skippy’s neighbor from Exercise 19 in Section 2.3. Sally also wants to plant a vegetable garden along the side of her home. She doesn’t have any fencing, but wants to keep the size of the garden to 100 square feet. What are the dimensions of the garden which will minimize the amount of fencing she needs to buy? What is the minimum amount of fencing she needs to buy? Round your answers to the nearest foot. (Note: Since one side of the garden will border the house, Sally doesn’t need fencing along that side.)
30. Another Classic Problem: A can is made in the shape of a right circular cylinder and is to hold one pint. (For dry goods, one pint is equal to 33.6 cubic inches.)¹⁴
- Find an expression for the volume V of the can in terms of the height h and the base radius r .
 - Find an expression for the surface area S of the can in terms of the height h and the base radius r . (Hint: The top and bottom of the can are circles of radius r and the side of the can is really just a rectangle that has been bent into a cylinder.)
 - Using the fact that $V = 33.6$, write S as a function of r and state its applied domain.
 - Use your graphing calculator to find the dimensions of the can which has minimal surface area.
31. A right cylindrical drum is to hold 7.35 cubic feet of liquid. Find the dimensions (radius of the base and height) of the drum which would minimize the surface area. What is the minimum surface area? Round your answers to two decimal places.
32. In Exercise 71 in Section 1.4, the population of Sasquatch in Portage County was modeled by the function $P(t) = \frac{150t}{t+15}$, where $t = 0$ represents the year 1803. When were there fewer than 100 Sasquatch in Portage County?

¹³1.62 is a crude approximation of the so-called ‘Golden Ratio’ $\phi = \frac{1+\sqrt{5}}{2}$.

¹⁴According to www.dictionary.com, there are different values given for this conversion. We will stick with 33.6in^3 for this problem.

In Exercises 33 - 38, translate the following into mathematical equations.

33. At a constant pressure, the temperature T of an ideal gas is directly proportional to its volume V . (This is [Charles's Law](#))
34. The frequency of a wave f is inversely proportional to the wavelength of the wave λ .
35. The density d of a material is directly proportional to the mass of the object m and inversely proportional to its volume V .
36. The square of the orbital period of a planet P is directly proportional to the cube of the semi-major axis of its orbit a . (This is [Kepler's Third Law of Planetary Motion](#))
37. The drag of an object traveling through a fluid D varies jointly with the density of the fluid ρ and the square of the velocity of the object ν .
38. Suppose two electric point charges, one with charge q and one with charge Q , are positioned r units apart. The electrostatic force F exerted on the charges varies directly with the product of the two charges and inversely with the square of the distance between the charges. (This is [Coulomb's Law](#))
39. According to [this webpage](#), the frequency f of a vibrating string is given by $f = \frac{1}{2L} \sqrt{\frac{T}{\mu}}$ where T is the tension, μ is the linear mass¹⁵ of the string and L is the length of the vibrating part of the string. Express this relationship using the language of variation.
40. According to the Centers for Disease Control and Prevention www.cdc.gov, a person's Body Mass Index B is directly proportional to his weight W in pounds and inversely proportional to the square of his height h in inches.
 - (a) Express this relationship as a mathematical equation.
 - (b) If a person who was 5 feet, 10 inches tall weighed 235 pounds had a Body Mass Index of 33.7, what is the value of the constant of proportionality?
 - (c) Rewrite the mathematical equation found in part 40a to include the value of the constant found in part 40b and then find your Body Mass Index.
41. We know that the circumference of a circle varies directly with its radius with 2π as the constant of proportionality. (That is, we know $C = 2\pi r$.) With the help of your classmates, compile a list of other basic geometric relationships which can be seen as variations.

¹⁵Also known as the linear density. It is simply a measure of mass per unit length.

4.3.3 ANSWERS

1. $x = -\frac{6}{7}$
2. $x = 1, x = 2$
3. $x = -1$
4. $x = -6, x = 2$
5. No solution
6. $x = 0, x = \pm 2\sqrt{2}$
7. $(-2, \infty)$
8. $(-2, 3]$
9. $(-1, 0) \cup (1, \infty)$
10. $[0, \infty)$
11. $(-\infty, -3) \cup (-3, 2) \cup (4, \infty)$
12. $(-3, -\frac{1}{3}) \cup (2, 3)$
13. $(-1, 0] \cup (2, \infty)$
14. $(-\infty, -3) \cup (-2, -1) \cup (1, \infty)$
15. $(-\infty, 1] \cup [2, \infty)$
16. $(-\infty, -6) \cup (-1, 2)$
17. $(-\infty, -3) \cup [-2\sqrt{2}, 0] \cup [2\sqrt{2}, 3)$
18. No solution
19. $[-3, 0) \cup (0, 4) \cup [5, \infty)$
20. $(-1, -\frac{1}{2}] \cup (1, \infty)$
21. 4.5 miles per hour
22. 24 miles per hour
23. 3600 gallons
24. $\frac{40}{3} \approx 13.33$ minutes
25. 3 hours
26. The absolute minimum of $y = \bar{C}(x)$ occurs at $\approx (75.73, 59.57)$. Since x represents the number of game systems, we check $\bar{C}(75) \approx 59.58$ and $\bar{C}(76) \approx 59.57$. Hence, to minimize the average cost, 76 systems should be produced at an average cost of \$59.57 per system.
27. The width (and depth) should be 10.00 centimeters, the height should be 5.00 centimeters. The minimum surface area is 300.00 square centimeters.
28. The width of the base of the box should be ≈ 4.12 inches, the height of the box should be ≈ 6.67 inches, and the depth of the base of the box should be ≈ 5.09 inches; minimum surface area ≈ 164.91 square inches.
29. The dimensions are ≈ 7 feet by ≈ 14 feet; minimum amount of fencing required ≈ 28 feet.
30. (a) $V = \pi r^2 h$
- (b) $S = 2\pi r^2 + 2\pi r h$
- (c) $S(r) = 2\pi r^2 + \frac{67.2}{r}$, Domain $r > 0$
- (d) $r \approx 1.749$ in. and $h \approx 3.498$ in.
31. The radius of the drum should be ≈ 1.05 feet and the height of the drum should be ≈ 2.12 feet. The minimum surface area of the drum is ≈ 20.93 cubic feet.
32. $P(t) < 100$ on $(-15, 30)$, and the portion of this which lies in the applied domain is $[0, 30)$. Since $t = 0$ corresponds to the year 1803, from 1803 through the end of 1832, there were fewer than 100 Sasquatch in Portage County.

33. $T = kV$

34. ¹⁶ $f = \frac{k}{\lambda}$

35. $d = \frac{km}{V}$

36. $P^2 = ka^3$

37. ¹⁷ $D = k\rho\nu^2$

38. ¹⁸ $F = \frac{kqQ}{r^2}$

39. Rewriting $f = \frac{1}{2L}\sqrt{\frac{T}{\mu}}$ as $f = \frac{\frac{1}{2}\sqrt{T}}{L\sqrt{\mu}}$ we see that the frequency f varies directly with the square root of the tension and varies inversely with the length and the square root of the linear mass.

40. (a) $B = \frac{kW}{h^2}$

(b) ¹⁹ $k = 702.68$

(c) $B = \frac{702.68W}{h^2}$

¹⁶The character λ is the lower case Greek letter 'lambda.'

¹⁷The characters ρ and ν are the lower case Greek letters 'rho' and 'nu,' respectively.

¹⁸Note the similarity to this formula and Newton's Law of Universal Gravitation as discussed in Example 5.

¹⁹The CDC uses 703.

CHAPTER 5

FURTHER TOPICS IN FUNCTIONS

5.1 FUNCTION COMPOSITION

Before we embark upon any further adventures with functions, we need to take some time to gather our thoughts and gain some perspective. Chapter 1 first introduced us to functions in Section 1.3. At that time, functions were specific kinds of relations - sets of points in the plane which passed the Vertical Line Test, Theorem 1.1. In Section 1.4, we developed the idea that functions are processes - rules which match inputs to outputs - and this gave rise to the concepts of domain and range. We spoke about how functions could be combined in Section 1.5 using the four basic arithmetic operations, took a more detailed look at their graphs in Section 1.6 and studied how their graphs behaved under certain classes of transformations in Section 1.7. In Chapter 2, we took a closer look at three families of functions: linear functions (Section 2.1), absolute value functions¹ (Section 2.2), and quadratic functions (Section 2.3). Linear and quadratic functions were special cases of polynomial functions, which we studied in generality in Chapter 3. Chapter 3 culminated with the Real Factorization Theorem, Theorem 3.16, which says that all polynomial functions with real coefficients can be thought of as products of linear and quadratic functions. Our next step was to enlarge our field² of study to rational functions in Chapter 4. Being quotients of polynomials, we can ultimately view this family of functions as being built up of linear and quadratic functions as well. So in some sense, Chapters 2, 3, and 4 can be thought of as an exhaustive study of linear and quadratic³ functions and their arithmetic combinations as described in Section 1.5. We now wish to study other algebraic functions, such as $f(x) = \sqrt{x}$ and $g(x) = x^{2/3}$, and the purpose of the first two sections of this chapter is to see how these kinds of functions arise from polynomial and rational functions. To that end, we first study a new way to combine functions as defined below.

¹These were introduced, as you may recall, as piecewise-defined linear functions.

²This is a really bad math pun.

³If we broaden our concept of functions to allow for complex valued coefficients, the Complex Factorization Theorem, Theorem 3.14, tells us every function we have studied thus far is a combination of linear functions.

Definition 5.1. Suppose f and g are two functions. The **composite** of g with f , denoted $g \circ f$, is defined by the formula $(g \circ f)(x) = g(f(x))$, provided x is an element of the domain of f and $f(x)$ is an element of the domain of g .

The quantity $g \circ f$ is also read ‘ g composed with f ’ or, more simply ‘ g of f .’ At its most basic level, Definition 5.1 tells us to obtain the formula for $(g \circ f)(x)$, we replace every occurrence of x in the formula for $g(x)$ with the formula we have for $f(x)$. If we take a step back and look at this from a procedural, ‘inputs and outputs’ perspective, Definition 5.1 tells us the output from $g \circ f$ is found by taking the output from f , $f(x)$, and then making that the input to g . The result, $g(f(x))$, is the output from $g \circ f$. From this perspective, we see $g \circ f$ as a two step process taking an input x and first applying the procedure f then applying the procedure g . Abstractly, we have

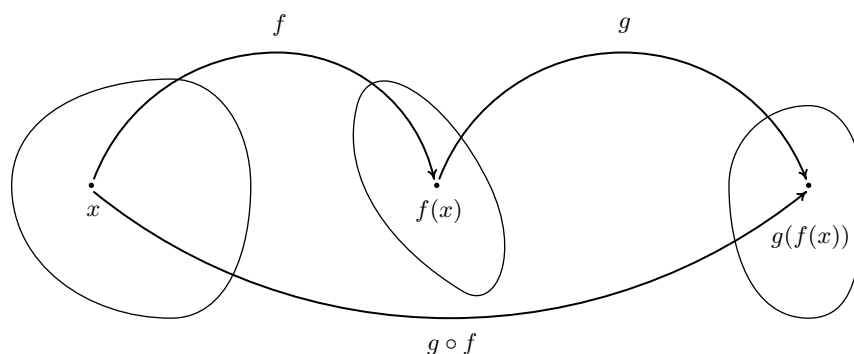

In the expression $g(f(x))$, the function f is often called the ‘inside’ function while g is often called the ‘outside’ function. There are two ways to go about evaluating composite functions - ‘inside out’ and ‘outside in’ - depending on which function we replace with its formula first. Both ways are demonstrated in the following example.

Example 5.1.1. Let $f(x) = x^2 - 4x$, $g(x) = 2 - \sqrt{x+3}$, and $h(x) = \frac{2x}{x+1}$.

In numbers 1 - 3, find the indicated function value.

1. $(g \circ f)(1)$
2. $(f \circ g)(1)$
3. $(g \circ g)(6)$

In numbers 4 - 10, find and simplify the indicated composite functions. State the domain of each.

4. $(g \circ f)(x)$
5. $(f \circ g)(x)$
6. $(g \circ h)(x)$
7. $(h \circ g)(x)$
8. $(h \circ h)(x)$
9. $(h \circ (g \circ f))(x)$
10. $((h \circ g) \circ f)(x)$

Solution.

1. Using Definition 5.1, $(g \circ f)(1) = g(f(1))$. We find $f(1) = -3$, so

$$(g \circ f)(1) = g(f(1)) = g(-3) = 2$$

2. As before, we use Definition 5.1 to write $(f \circ g)(1) = f(g(1))$. We find $g(1) = 0$, so

$$(f \circ g)(1) = f(g(1)) = f(0) = 0$$

3. Once more, Definition 5.1 tells us $(g \circ g)(6) = g(g(6))$. That is, we evaluate g at 6, then plug that result back into g . Since $g(6) = -1$,

$$(g \circ g)(6) = g(g(6)) = g(-1) = 2 - \sqrt{2}$$

4. By definition, $(g \circ f)(x) = g(f(x))$. We now illustrate *two* ways to approach this problem.

- *inside out*: We insert the expression $f(x)$ into g first to get

$$(g \circ f)(x) = g(f(x)) = g(x^2 - 4x) = 2 - \sqrt{(x^2 - 4x) + 3} = 2 - \sqrt{x^2 - 4x + 3}$$

Hence, $(g \circ f)(x) = 2 - \sqrt{x^2 - 4x + 3}$.

- *outside in*: We use the formula for g first to get

$$(g \circ f)(x) = g(f(x)) = 2 - \sqrt{f(x) + 3} = 2 - \sqrt{(x^2 - 4x) + 3} = 2 - \sqrt{x^2 - 4x + 3}$$

We get the same answer as before, $(g \circ f)(x) = 2 - \sqrt{x^2 - 4x + 3}$.

To find the domain of $g \circ f$, we need to find the elements in the domain of f whose outputs $f(x)$ are in the domain of g . We accomplish this by following the rule set forth in Section 1.4, that is, we find the domain *before* we simplify. To that end, we examine $(g \circ f)(x) = 2 - \sqrt{(x^2 - 4x) + 3}$. To keep the square root happy, we solve the inequality $x^2 - 4x + 3 \geq 0$ by creating a sign diagram. If we let $r(x) = x^2 - 4x + 3$, we find the zeros of r to be $x = 1$ and $x = 3$. We obtain

$$\begin{array}{ccccccc} & (+) & 0 & (-) & 0 & (+) & \\ & & | & & | & & \\ \leftarrow & & 1 & & 3 & & \rightarrow \end{array}$$

Our solution to $x^2 - 4x + 3 \geq 0$, and hence the domain of $g \circ f$, is $(-\infty, 1] \cup [3, \infty)$.

5. To find $(f \circ g)(x)$, we find $f(g(x))$.

- *inside out*: We insert the expression $g(x)$ into f first to get

$$\begin{aligned} (f \circ g)(x) &= f(g(x)) = f(2 - \sqrt{x + 3}) \\ &= (2 - \sqrt{x + 3})^2 - 4(2 - \sqrt{x + 3}) \\ &= 4 - 4\sqrt{x + 3} + (\sqrt{x + 3})^2 - 8 + 4\sqrt{x + 3} \\ &= 4 + x + 3 - 8 \\ &= x - 1 \end{aligned}$$

- *outside in*: We use the formula for $f(x)$ first to get

$$\begin{aligned}(f \circ g)(x) &= f(g(x)) = (g(x))^2 - 4(g(x)) \\ &= (2 - \sqrt{x+3})^2 - 4(2 - \sqrt{x+3}) \\ &= x - 1\end{aligned}$$

same algebra as before

Thus we get $(f \circ g)(x) = x - 1$. To find the domain of $(f \circ g)$, we look to the step before we did any simplification and find $(f \circ g)(x) = (2 - \sqrt{x+3})^2 - 4(2 - \sqrt{x+3})$. To keep the square root happy, we set $x + 3 \geq 0$ and find our domain to be $[-3, \infty)$.

6. To find $(g \circ h)(x)$, we compute $g(h(x))$.

- *inside out*: We insert the expression $h(x)$ into g first to get

$$\begin{aligned}(g \circ h)(x) &= g(h(x)) = g\left(\frac{2x}{x+1}\right) \\ &= 2 - \sqrt{\left(\frac{2x}{x+1}\right) + 3} \\ &= 2 - \sqrt{\frac{2x}{x+1} + \frac{3(x+1)}{x+1}} \quad \text{get common denominators} \\ &= 2 - \sqrt{\frac{5x+3}{x+1}}\end{aligned}$$

- *outside in*: We use the formula for $g(x)$ first to get

$$\begin{aligned}(g \circ h)(x) &= g(h(x)) = 2 - \sqrt{h(x) + 3} \\ &= 2 - \sqrt{\left(\frac{2x}{x+1}\right) + 3} \\ &= 2 - \sqrt{\frac{5x+3}{x+1}} \quad \text{get common denominators as before}\end{aligned}$$

To find the domain of $(g \circ h)$, we look to the step before we began to simplify:

$$(g \circ h)(x) = 2 - \sqrt{\left(\frac{2x}{x+1}\right) + 3}$$

To avoid division by zero, we need $x \neq -1$. To keep the radical happy, we need to solve

$$\frac{2x}{x+1} + 3 = \frac{5x+3}{x+1} \geq 0$$

Defining $r(x) = \frac{5x+3}{x+1}$, we see r is undefined at $x = -1$ and $r(x) = 0$ at $x = -\frac{3}{5}$. We get

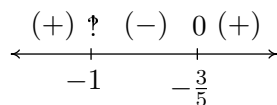

Our domain is $(-\infty, -1) \cup [-\frac{3}{5}, \infty)$.

7. We find $(h \circ g)(x)$ by finding $h(g(x))$.

- *inside out*: We insert the expression $g(x)$ into h first to get

$$\begin{aligned}(h \circ g)(x) &= h(g(x)) = h(2 - \sqrt{x+3}) \\ &= \frac{2(2 - \sqrt{x+3})}{(2 - \sqrt{x+3}) + 1} \\ &= \frac{4 - 2\sqrt{x+3}}{3 - \sqrt{x+3}}\end{aligned}$$

- *outside in*: We use the formula for $h(x)$ first to get

$$\begin{aligned}(h \circ g)(x) &= h(g(x)) = \frac{2(g(x))}{(g(x)) + 1} \\ &= \frac{2(2 - \sqrt{x+3})}{(2 - \sqrt{x+3}) + 1} \\ &= \frac{4 - 2\sqrt{x+3}}{3 - \sqrt{x+3}}\end{aligned}$$

To find the domain of $h \circ g$, we look to the step before any simplification:

$$(h \circ g)(x) = \frac{2(2 - \sqrt{x+3})}{(2 - \sqrt{x+3}) + 1}$$

To keep the square root happy, we require $x+3 \geq 0$ or $x \geq -3$. Setting the denominator equal to zero gives $(2 - \sqrt{x+3}) + 1 = 0$ or $\sqrt{x+3} = 3$. Squaring both sides gives us $x+3 = 9$, or $x = 6$. Since $x = 6$ checks in the original equation, $(2 - \sqrt{x+3}) + 1 = 0$, we know $x = 6$ is the only zero of the denominator. Hence, the domain of $h \circ g$ is $[-3, 6) \cup (6, \infty)$.

8. To find $(h \circ h)(x)$, we substitute the function h into itself, $h(h(x))$.

- *inside out*: We insert the expression $h(x)$ into h to get

$$(h \circ h)(x) = h(h(x)) = h\left(\frac{2x}{x+1}\right)$$

$$\begin{aligned}
&= \frac{2\left(\frac{2x}{x+1}\right)}{\left(\frac{2x}{x+1}\right) + 1} \\
&= \frac{\frac{4x}{x+1} \cdot (x+1)}{\frac{2x}{x+1} + 1 \cdot (x+1)} \\
&= \frac{\frac{4x}{x+1} \cdot (x+1)}{\left(\frac{2x}{x+1}\right) \cdot (x+1) + 1 \cdot (x+1)} \\
&= \frac{\cancel{(x+1)} \cdot 4x}{\cancel{(x+1)} \cdot 2x + \cancel{(x+1)} + x + 1} \\
&= \frac{4x}{3x+1}
\end{aligned}$$

- *outside in*: This approach yields

$$\begin{aligned}
(h \circ h)(x) &= h(h(x)) = \frac{2(h(x))}{h(x) + 1} \\
&= \frac{2\left(\frac{2x}{x+1}\right)}{\left(\frac{2x}{x+1}\right) + 1} \\
&= \frac{4x}{3x+1} \qquad \text{same algebra as before}
\end{aligned}$$

To find the domain of $h \circ h$, we analyze

$$(h \circ h)(x) = \frac{2\left(\frac{2x}{x+1}\right)}{\left(\frac{2x}{x+1}\right) + 1}$$

To keep the denominator $x+1$ happy, we need $x \neq -1$. Setting the denominator

$$\frac{2x}{x+1} + 1 = 0$$

gives $x = -\frac{1}{3}$. Our domain is $(-\infty, -1) \cup (-1, -\frac{1}{3}) \cup (-\frac{1}{3}, \infty)$.

9. The expression $(h \circ (g \circ f))(x)$ indicates that we first find the composite, $g \circ f$ and compose the function h with the result. We know from number 1 that $(g \circ f)(x) = 2 - \sqrt{x^2 - 4x + 3}$. We now proceed as usual.

- *inside out*: We insert the expression $(g \circ f)(x)$ into h first to get

$$\begin{aligned} (h \circ (g \circ f))(x) &= h((g \circ f)(x)) = h\left(2 - \sqrt{x^2 - 4x + 3}\right) \\ &= \frac{2\left(2 - \sqrt{x^2 - 4x + 3}\right)}{\left(2 - \sqrt{x^2 - 4x + 3}\right) + 1} \\ &= \frac{4 - 2\sqrt{x^2 - 4x + 3}}{3 - \sqrt{x^2 - 4x + 3}} \end{aligned}$$

- *outside in*: We use the formula for $h(x)$ first to get

$$\begin{aligned} (h \circ (g \circ f))(x) &= h((g \circ f)(x)) = \frac{2((g \circ f)(x))}{((g \circ f)(x)) + 1} \\ &= \frac{2\left(2 - \sqrt{x^2 - 4x + 3}\right)}{\left(2 - \sqrt{x^2 - 4x + 3}\right) + 1} \\ &= \frac{4 - 2\sqrt{x^2 - 4x + 3}}{3 - \sqrt{x^2 - 4x + 3}} \end{aligned}$$

To find the domain of $(h \circ (g \circ f))$, we look at the step before we began to simplify,

$$(h \circ (g \circ f))(x) = \frac{2\left(2 - \sqrt{x^2 - 4x + 3}\right)}{\left(2 - \sqrt{x^2 - 4x + 3}\right) + 1}$$

For the square root, we need $x^2 - 4x + 3 \geq 0$, which we determined in number 1 to be $(-\infty, 1] \cup [3, \infty)$. Next, we set the denominator to zero and solve: $\left(2 - \sqrt{x^2 - 4x + 3}\right) + 1 = 0$. We get $\sqrt{x^2 - 4x + 3} = 3$, and, after squaring both sides, we have $x^2 - 4x + 3 = 9$. To solve $x^2 - 4x - 6 = 0$, we use the quadratic formula and get $x = 2 \pm \sqrt{10}$. The reader is encouraged to check that both of these numbers satisfy the original equation, $\left(2 - \sqrt{x^2 - 4x + 3}\right) + 1 = 0$. Hence we must exclude these numbers from the domain of $h \circ (g \circ f)$. Our final domain for $h \circ (f \circ g)$ is $(-\infty, 2 - \sqrt{10}) \cup (2 - \sqrt{10}, 1] \cup [3, 2 + \sqrt{10}) \cup (2 + \sqrt{10}, \infty)$.

10. The expression $((h \circ g) \circ f)(x)$ indicates that we first find the composite $h \circ g$ and then compose that with f . From number 4, we have

$$(h \circ g)(x) = \frac{4 - 2\sqrt{x + 3}}{3 - \sqrt{x + 3}}$$

We now proceed as before.

- *inside out*: We insert the expression $f(x)$ into $h \circ g$ first to get

$$\begin{aligned} ((h \circ g) \circ f)(x) &= (h \circ g)(f(x)) = (h \circ g)(x^2 - 4x) \\ &= \frac{4 - 2\sqrt{(x^2 - 4x) + 3}}{3 - \sqrt{(x^2 - 4x) + 3}} \\ &= \frac{4 - 2\sqrt{x^2 - 4x + 3}}{3 - \sqrt{x^2 - 4x + 3}} \end{aligned}$$

- *outside in*: We use the formula for $(h \circ g)(x)$ first to get

$$\begin{aligned} ((h \circ g) \circ f)(x) &= (h \circ g)(f(x)) = \frac{4 - 2\sqrt{f(x) + 3}}{3 - \sqrt{f(x) + 3}} \\ &= \frac{4 - 2\sqrt{(x^2 - 4x) + 3}}{3 - \sqrt{(x^2 - 4x) + 3}} \\ &= \frac{4 - 2\sqrt{x^2 - 4x + 3}}{3 - \sqrt{x^2 - 4x + 3}} \end{aligned}$$

We note that the formula for $((h \circ g) \circ f)(x)$ before simplification is identical to that of $(h \circ (g \circ f))(x)$ before we simplified it. Hence, the two functions have the same domain, $h \circ (f \circ g)$ is $(-\infty, 2 - \sqrt{10}) \cup (2 - \sqrt{10}, 1] \cup [3, 2 + \sqrt{10}) \cup (2 + \sqrt{10}, \infty)$. \square

It should be clear from Example 5.1.1 that, in general, when you compose two functions, such as f and g above, the order matters.⁴ We found that the functions $f \circ g$ and $g \circ f$ were different as were $g \circ h$ and $h \circ g$. Thinking of functions as processes, this isn't all that surprising. If we think of one process as putting on our socks, and the other as putting on our shoes, the order in which we do these two tasks does matter.⁵ Also note the importance of finding the domain of the composite function *before* simplifying. For instance, the domain of $f \circ g$ is much different than its simplified formula would indicate. Composing a function with itself, as in the case of finding $(g \circ g)(6)$ and $(h \circ h)(x)$, may seem odd. Looking at this from a procedural perspective, however, this merely indicates performing a task h and then doing it again - like setting the washing machine to do a 'double rinse'. Composing a function with itself is called 'iterating' the function, and we could easily spend an entire course on just that. The last two problems in Example 5.1.1 serve to demonstrate the **associative** property of functions. That is, when composing three (or more) functions, as long as we keep the order the same, it doesn't matter which two functions we compose first. This property as well as another important property are listed in the theorem below.

⁴This shows us function composition isn't **commutative**. An example of an operation we perform on two functions which is commutative is function addition, which we defined in Section 1.5. In other words, the functions $f + g$ and $g + f$ are always equal. Which of the remaining operations on functions we have discussed are commutative?

⁵A more mathematical example in which the order of two processes matters can be found in Section 1.7. In fact, all of the transformations in that section can be viewed in terms of composing functions with linear functions.

Theorem 5.1. Properties of Function Composition: Suppose f , g , and h are functions.

- $h \circ (g \circ f) = (h \circ g) \circ f$, provided the composite functions are defined.
- If I is defined as $I(x) = x$ for all real numbers x , then $I \circ f = f \circ I = f$.

By repeated applications of Definition 5.1, we find $(h \circ (g \circ f))(x) = h((g \circ f)(x)) = h(g(f(x)))$. Similarly, $((h \circ g) \circ f)(x) = (h \circ g)(f(x)) = h(g(f(x)))$. This establishes that the formulas for the two functions are the same. We leave it to the reader to think about why the domains of these two functions are identical, too. These two facts establish the equality $h \circ (g \circ f) = (h \circ g) \circ f$. A consequence of the associativity of function composition is that there is no need for parentheses when we write $h \circ g \circ f$. The second property can also be verified using Definition 5.1. Recall that the function $I(x) = x$ is called the *identity function* and was introduced in Exercise 73 in Section 2.1. If we compose the function I with a function f , then we have $(I \circ f)(x) = I(f(x)) = f(x)$, and a similar computation shows $(f \circ I)(x) = f(x)$. This establishes that we have an identity for function composition much in the same way the real number 1 is an identity for real number multiplication. That is, just as for any real number x , $1 \cdot x = x \cdot 1 = x$, we have for any function f , $I \circ f = f \circ I = f$. We shall see the concept of an identity take on great significance in the next section. Out in the wild, function composition is often used to relate two quantities which may not be directly related, but have a variable in common, as illustrated in our next example.

Example 5.1.2. The surface area S of a sphere is a function of its radius r and is given by the formula $S(r) = 4\pi r^2$. Suppose the sphere is being inflated so that the radius of the sphere is increasing according to the formula $r(t) = 3t^2$, where t is measured in seconds, $t \geq 0$, and r is measured in inches. Find and interpret $(S \circ r)(t)$.

Solution. If we look at the functions $S(r)$ and $r(t)$ individually, we see the former gives the surface area of a sphere of a given radius while the latter gives the radius at a given time. So, given a specific time, t , we could find the radius at that time, $r(t)$ and feed that into $S(r)$ to find the surface area at that time. From this we see that the surface area S is ultimately a function of time t and we find $(S \circ r)(t) = S(r(t)) = 4\pi(r(t))^2 = 4\pi(3t^2)^2 = 36\pi t^4$. This formula allows us to compute the surface area directly given the time without going through the ‘middle man’ r . \square

A useful skill in Calculus is to be able to take a complicated function and break it down into a composition of easier functions which our last example illustrates.

Example 5.1.3. Write each of the following functions as a composition of two or more (non-identity) functions. Check your answer by performing the function composition.

$$1. F(x) = |3x - 1| \qquad 2. G(x) = \frac{2}{x^2 + 1} \qquad 3. H(x) = \frac{\sqrt{x} + 1}{\sqrt{x} - 1}$$

Solution. There are many approaches to this kind of problem, and we showcase a different methodology in each of the solutions below.

1. Our goal is to express the function F as $F = g \circ f$ for functions g and f . From Definition 5.1, we know $F(x) = g(f(x))$, and we can think of $f(x)$ as being the ‘inside’ function and g as being the ‘outside’ function. Looking at $F(x) = |3x - 1|$ from an ‘inside versus outside’ perspective, we can think of $3x - 1$ being inside the absolute value symbols. Taking this cue, we define $f(x) = 3x - 1$. At this point, we have $F(x) = |f(x)|$. What is the outside function? The function which takes the absolute value of its input, $g(x) = |x|$. Sure enough, $(g \circ f)(x) = g(f(x)) = |f(x)| = |3x - 1| = F(x)$, so we are done.
2. We attack deconstructing G from an operational approach. Given an input x , the first step is to square x , then add 1, then divide the result into 2. We will assign each of these steps a function so as to write G as a composite of three functions: f , g and h . Our first function, f , is the function that squares its input, $f(x) = x^2$. The next function is the function that adds 1 to its input, $g(x) = x + 1$. Our last function takes its input and divides it into 2, $h(x) = \frac{2}{x}$. The claim is that $G = h \circ g \circ f$. We find

$$(h \circ g \circ f)(x) = h(g(f(x))) = h(g(x^2)) = h(x^2 + 1) = \frac{2}{x^2 + 1} = G(x),$$

so we are done.

3. If we look $H(x) = \frac{\sqrt{x}+1}{\sqrt{x}-1}$ with an eye towards building a complicated function from simpler functions, we see the expression \sqrt{x} is a simple piece of the larger function. If we define $f(x) = \sqrt{x}$, we have $H(x) = \frac{f(x)+1}{f(x)-1}$. If we want to decompose $H = g \circ f$, then we can glean the formula for $g(x)$ by looking at what is being done to $f(x)$. We take $g(x) = \frac{x+1}{x-1}$, so

$$(g \circ f)(x) = g(f(x)) = \frac{f(x) + 1}{f(x) - 1} = \frac{\sqrt{x} + 1}{\sqrt{x} - 1} = H(x),$$

as required. □

5.1.1 EXERCISES

In Exercises 1 - 12, use the given pair of functions to find the following values if they exist.

- $(g \circ f)(0)$
 - $(f \circ g)(-1)$
 - $(f \circ f)(2)$
 - $(g \circ f)(-3)$
 - $(f \circ g)(\frac{1}{2})$
 - $(f \circ f)(-2)$
1. $f(x) = x^2, g(x) = 2x + 1$
 2. $f(x) = 4 - x, g(x) = 1 - x^2$
 3. $f(x) = 4 - 3x, g(x) = |x|$
 4. $f(x) = |x - 1|, g(x) = x^2 - 5$
 5. $f(x) = 4x + 5, g(x) = \sqrt{x}$
 6. $f(x) = \sqrt{3 - x}, g(x) = x^2 + 1$
 7. $f(x) = 6 - x - x^2, g(x) = x\sqrt{x + 10}$
 8. $f(x) = \sqrt[3]{x + 1}, g(x) = 4x^2 - x$
 9. $f(x) = \frac{3}{1 - x}, g(x) = \frac{4x}{x^2 + 1}$
 10. $f(x) = \frac{x}{x + 5}, g(x) = \frac{2}{7 - x^2}$
 11. $f(x) = \frac{2x}{5 - x^2}, g(x) = \sqrt{4x + 1}$
 12. $f(x) = \sqrt{2x + 5}, g(x) = \frac{10x}{x^2 + 1}$

In Exercises 13 - 24, use the given pair of functions to find and simplify expressions for the following functions and state the domain of each using interval notation.

- $(g \circ f)(x)$
 - $(f \circ g)(x)$
 - $(f \circ f)(x)$
13. $f(x) = 2x + 3, g(x) = x^2 - 9$
 14. $f(x) = x^2 - x + 1, g(x) = 3x - 5$
 15. $f(x) = x^2 - 4, g(x) = |x|$
 16. $f(x) = 3x - 5, g(x) = \sqrt{x}$
 17. $f(x) = |x + 1|, g(x) = \sqrt{x}$
 18. $f(x) = 3 - x^2, g(x) = \sqrt{x + 1}$
 19. $f(x) = |x|, g(x) = \sqrt{4 - x}$
 20. $f(x) = x^2 - x - 1, g(x) = \sqrt{x - 5}$
 21. $f(x) = 3x - 1, g(x) = \frac{1}{x + 3}$
 22. $f(x) = \frac{3x}{x - 1}, g(x) = \frac{x}{x - 3}$
 23. $f(x) = \frac{x}{2x + 1}, g(x) = \frac{2x + 1}{x}$
 24. $f(x) = \frac{2x}{x^2 - 4}, g(x) = \sqrt{1 - x}$

In Exercises 25 - 30, use $f(x) = -2x$, $g(x) = \sqrt{x}$ and $h(x) = |x|$ to find and simplify expressions for the following functions and state the domain of each using interval notation.

25. $(h \circ g \circ f)(x)$

26. $(h \circ f \circ g)(x)$

27. $(g \circ f \circ h)(x)$

28. $(g \circ h \circ f)(x)$

29. $(f \circ h \circ g)(x)$

30. $(f \circ g \circ h)(x)$

In Exercises 31 - 40, write the given function as a composition of two or more non-identity functions. (There are several correct answers, so check your answer using function composition.)

31. $p(x) = (2x + 3)^3$

32. $P(x) = (x^2 - x + 1)^5$

33. $h(x) = \sqrt{2x - 1}$

34. $H(x) = |7 - 3x|$

35. $r(x) = \frac{2}{5x + 1}$

36. $R(x) = \frac{7}{x^2 - 1}$

37. $q(x) = \frac{|x| + 1}{|x| - 1}$

38. $Q(x) = \frac{2x^3 + 1}{x^3 - 1}$

39. $v(x) = \frac{2x + 1}{3 - 4x}$

40. $w(x) = \frac{x^2}{x^4 + 1}$

41. Write the function $F(x) = \sqrt{\frac{x^3 + 6}{x^3 - 9}}$ as a composition of three or more non-identity functions.

42. Let $g(x) = -x$, $h(x) = x + 2$, $j(x) = 3x$ and $k(x) = x - 4$. In what order must these functions be composed with $f(x) = \sqrt{x}$ to create $F(x) = 3\sqrt{-x + 2} - 4$?

43. What linear functions could be used to transform $f(x) = x^3$ into $F(x) = -\frac{1}{2}(2x - 7)^3 + 1$? What is the proper order of composition?

In Exercises 44 - 55, let f be the function defined by

$$f = \{(-3, 4), (-2, 2), (-1, 0), (0, 1), (1, 3), (2, 4), (3, -1)\}$$

and let g be the function defined

$$g = \{(-3, -2), (-2, 0), (-1, -4), (0, 0), (1, -3), (2, 1), (3, 2)\}$$

. Find the value if it exists.

44. $(f \circ g)(3)$

45. $f(g(-1))$

46. $(f \circ f)(0)$

47. $(f \circ g)(-3)$

48. $(g \circ f)(3)$

49. $g(f(-3))$

50. $(g \circ g)(-2)$

51. $(g \circ f)(-2)$

52. $g(f(g(0)))$

53. $f(f(f(-1)))$

54. $f(f(f(f(f(1))))))$

55. $\underbrace{(g \circ g \circ \cdots \circ g)}_{n \text{ times}}(0)$

In Exercises 56 - 61, use the graphs of $y = f(x)$ and $y = g(x)$ below to find the function value.

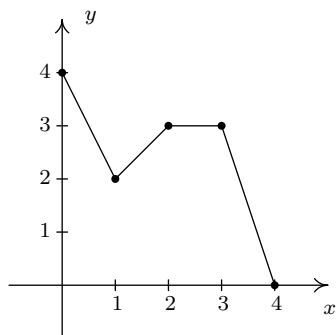
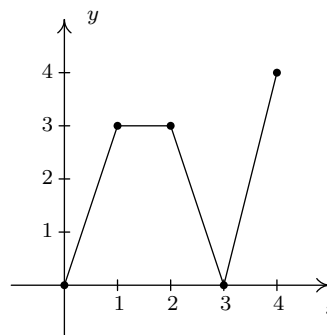
 $y = f(x)$  $y = g(x)$

56. $(g \circ f)(1)$

57. $(f \circ g)(3)$

58. $(g \circ f)(2)$

59. $(f \circ g)(0)$

60. $(f \circ f)(1)$

61. $(g \circ g)(1)$

62. The volume V of a cube is a function of its side length x . Let's assume that $x = t + 1$ is also a function of time t , where x is measured in inches and t is measured in minutes. Find a formula for V as a function of t .

63. Suppose a local vendor charges \$2 per hot dog and that the number of hot dogs sold per hour x is given by $x(t) = -4t^2 + 20t + 92$, where t is the number of hours since 10 AM, $0 \leq t \leq 4$.

(a) Find an expression for the revenue per hour R as a function of x .

(b) Find and simplify $(R \circ x)(t)$. What does this represent?

(c) What is the revenue per hour at noon?

64. Discuss with your classmates how 'real-world' processes such as filling out federal income tax forms or computing your final course grade could be viewed as a use of function composition. Find a process for which composition with itself (iteration) makes sense.

5.1.2 ANSWERS

1. For $f(x) = x^2$ and $g(x) = 2x + 1$,

- $(g \circ f)(0) = 1$
- $(f \circ g)(-1) = 1$
- $(f \circ f)(2) = 16$
- $(g \circ f)(-3) = 19$
- $(f \circ g)\left(\frac{1}{2}\right) = 4$
- $(f \circ f)(-2) = 16$

2. For $f(x) = 4 - x$ and $g(x) = 1 - x^2$,

- $(g \circ f)(0) = -15$
- $(f \circ g)(-1) = 4$
- $(f \circ f)(2) = 2$
- $(g \circ f)(-3) = -48$
- $(f \circ g)\left(\frac{1}{2}\right) = \frac{13}{4}$
- $(f \circ f)(-2) = -2$

3. For $f(x) = 4 - 3x$ and $g(x) = |x|$,

- $(g \circ f)(0) = 4$
- $(f \circ g)(-1) = 1$
- $(f \circ f)(2) = 10$
- $(g \circ f)(-3) = 13$
- $(f \circ g)\left(\frac{1}{2}\right) = \frac{5}{2}$
- $(f \circ f)(-2) = -26$

4. For $f(x) = |x - 1|$ and $g(x) = x^2 - 5$,

- $(g \circ f)(0) = -4$
- $(f \circ g)(-1) = 5$
- $(f \circ f)(2) = 0$
- $(g \circ f)(-3) = 11$
- $(f \circ g)\left(\frac{1}{2}\right) = \frac{23}{4}$
- $(f \circ f)(-2) = 2$

5. For $f(x) = 4x + 5$ and $g(x) = \sqrt{x}$,

- $(g \circ f)(0) = \sqrt{5}$
- $(f \circ g)(-1)$ is not real
- $(f \circ f)(2) = 57$
- $(g \circ f)(-3)$ is not real
- $(f \circ g)\left(\frac{1}{2}\right) = 5 + 2\sqrt{2}$
- $(f \circ f)(-2) = -7$

6. For $f(x) = \sqrt{3 - x}$ and $g(x) = x^2 + 1$,

- $(g \circ f)(0) = 4$
- $(f \circ g)(-1) = 1$
- $(f \circ f)(2) = \sqrt{2}$
- $(g \circ f)(-3) = 7$
- $(f \circ g)\left(\frac{1}{2}\right) = \frac{\sqrt{7}}{2}$
- $(f \circ f)(-2) = \sqrt{3 - \sqrt{5}}$

7. For $f(x) = 6 - x - x^2$ and $g(x) = x\sqrt{x+10}$,

- $(g \circ f)(0) = 24$
- $(f \circ g)(-1) = 0$
- $(f \circ f)(2) = 6$
- $(g \circ f)(-3) = 0$
- $(f \circ g)\left(\frac{1}{2}\right) = \frac{27-2\sqrt{42}}{8}$
- $(f \circ f)(-2) = -14$

8. For $f(x) = \sqrt[3]{x+1}$ and $g(x) = 4x^2 - x$,

- $(g \circ f)(0) = 3$
- $(f \circ g)(-1) = \sqrt[3]{6}$
- $(f \circ f)(2) = \sqrt[3]{\sqrt[3]{3}+1}$
- $(g \circ f)(-3) = 4\sqrt[3]{4} + \sqrt[3]{2}$
- $(f \circ g)\left(\frac{1}{2}\right) = \frac{\sqrt[3]{12}}{2}$
- $(f \circ f)(-2) = 0$

9. For $f(x) = \frac{3}{1-x}$ and $g(x) = \frac{4x}{x^2+1}$,

- $(g \circ f)(0) = \frac{6}{5}$
- $(f \circ g)(-1) = 1$
- $(f \circ f)(2) = \frac{3}{4}$
- $(g \circ f)(-3) = \frac{48}{25}$
- $(f \circ g)\left(\frac{1}{2}\right) = -5$
- $(f \circ f)(-2)$ is undefined

10. For $f(x) = \frac{x}{x+5}$ and $g(x) = \frac{2}{7-x^2}$,

- $(g \circ f)(0) = \frac{2}{7}$
- $(f \circ g)(-1) = \frac{1}{16}$
- $(f \circ f)(2) = \frac{2}{37}$
- $(g \circ f)(-3) = \frac{8}{19}$
- $(f \circ g)\left(\frac{1}{2}\right) = \frac{8}{143}$
- $(f \circ f)(-2) = -\frac{2}{13}$

11. For $f(x) = \frac{2x}{5-x^2}$ and $g(x) = \sqrt{4x+1}$,

- $(g \circ f)(0) = 1$
- $(f \circ g)(-1)$ is not real
- $(f \circ f)(2) = -\frac{8}{11}$
- $(g \circ f)(-3) = \sqrt{7}$
- $(f \circ g)\left(\frac{1}{2}\right) = \sqrt{3}$
- $(f \circ f)(-2) = \frac{8}{11}$

12. For $f(x) = \sqrt{2x+5}$ and $g(x) = \frac{10x}{x^2+1}$,

- $(g \circ f)(0) = \frac{5\sqrt{5}}{3}$
- $(f \circ g)(-1)$ is not real
- $(f \circ f)(2) = \sqrt{11}$
- $(g \circ f)(-3)$ is not real
- $(f \circ g)\left(\frac{1}{2}\right) = \sqrt{13}$
- $(f \circ f)(-2) = \sqrt{7}$

13. For $f(x) = 2x + 3$ and $g(x) = x^2 - 9$

- $(g \circ f)(x) = 4x^2 + 12x$, domain: $(-\infty, \infty)$
- $(f \circ g)(x) = 2x^2 - 15$, domain: $(-\infty, \infty)$
- $(f \circ f)(x) = 4x + 9$, domain: $(-\infty, \infty)$

14. For $f(x) = x^2 - x + 1$ and $g(x) = 3x - 5$

- $(g \circ f)(x) = 3x^2 - 3x - 2$, domain: $(-\infty, \infty)$
- $(f \circ g)(x) = 9x^2 - 33x + 31$, domain: $(-\infty, \infty)$
- $(f \circ f)(x) = x^4 - 2x^3 + 2x^2 - x + 1$, domain: $(-\infty, \infty)$

15. For $f(x) = x^2 - 4$ and $g(x) = |x|$

- $(g \circ f)(x) = |x^2 - 4|$, domain: $(-\infty, \infty)$
- $(f \circ g)(x) = |x|^2 - 4 = x^2 - 4$, domain: $(-\infty, \infty)$
- $(f \circ f)(x) = x^4 - 8x^2 + 12$, domain: $(-\infty, \infty)$

16. For $f(x) = 3x - 5$ and $g(x) = \sqrt{x}$

- $(g \circ f)(x) = \sqrt{3x - 5}$, domain: $[\frac{5}{3}, \infty)$
- $(f \circ g)(x) = 3\sqrt{x} - 5$, domain: $[0, \infty)$
- $(f \circ f)(x) = 9x - 20$, domain: $(-\infty, \infty)$

17. For $f(x) = |x + 1|$ and $g(x) = \sqrt{x}$

- $(g \circ f)(x) = \sqrt{|x + 1|}$, domain: $(-\infty, \infty)$
- $(f \circ g)(x) = |\sqrt{x} + 1| = \sqrt{x} + 1$, domain: $[0, \infty)$
- $(f \circ f)(x) = ||x + 1| + 1| = |x + 1| + 1$, domain: $(-\infty, \infty)$

18. For $f(x) = 3 - x^2$ and $g(x) = \sqrt{x + 1}$

- $(g \circ f)(x) = \sqrt{4 - x^2}$, domain: $[-2, 2]$
- $(f \circ g)(x) = 2 - x$, domain: $[-1, \infty)$
- $(f \circ f)(x) = -x^4 + 6x^2 - 6$, domain: $(-\infty, \infty)$

19. For $f(x) = |x|$ and $g(x) = \sqrt{4 - x}$

- $(g \circ f)(x) = \sqrt{4 - |x|}$, domain: $[-4, 4]$
- $(f \circ g)(x) = |\sqrt{4 - x}| = \sqrt{4 - x}$, domain: $(-\infty, 4]$
- $(f \circ f)(x) = ||x|| = |x|$, domain: $(-\infty, \infty)$

20. For $f(x) = x^2 - x - 1$ and $g(x) = \sqrt{x - 5}$

- $(g \circ f)(x) = \sqrt{x^2 - x - 6}$, domain: $(-\infty, -2] \cup [3, \infty)$
- $(f \circ g)(x) = x - 6 - \sqrt{x - 5}$, domain: $[5, \infty)$
- $(f \circ f)(x) = x^4 - 2x^3 - 2x^2 + 3x + 1$, domain: $(-\infty, \infty)$

21. For $f(x) = 3x - 1$ and $g(x) = \frac{1}{x+3}$

- $(g \circ f)(x) = \frac{1}{3x+2}$, domain: $(-\infty, -\frac{2}{3}) \cup (-\frac{2}{3}, \infty)$
- $(f \circ g)(x) = -\frac{x}{x+3}$, domain: $(-\infty, -3) \cup (-3, \infty)$
- $(f \circ f)(x) = 9x - 4$, domain: $(-\infty, \infty)$

22. For $f(x) = \frac{3x}{x-1}$ and $g(x) = \frac{x}{x-3}$

- $(g \circ f)(x) = x$, domain: $(-\infty, 1) \cup (1, \infty)$
- $(f \circ g)(x) = x$, domain: $(-\infty, 3) \cup (3, \infty)$
- $(f \circ f)(x) = \frac{9x}{2x+1}$, domain: $(-\infty, -\frac{1}{2}) \cup (-\frac{1}{2}, 1) \cup (1, \infty)$

23. For $f(x) = \frac{x}{2x+1}$ and $g(x) = \frac{2x+1}{x}$

- $(g \circ f)(x) = \frac{4x+1}{x}$, domain: $(-\infty, -\frac{1}{2}) \cup (-\frac{1}{2}, 0) \cup (0, \infty)$
- $(f \circ g)(x) = \frac{2x+1}{5x+2}$, domain: $(-\infty, -\frac{2}{5}) \cup (-\frac{2}{5}, 0) \cup (0, \infty)$
- $(f \circ f)(x) = \frac{x}{4x+1}$, domain: $(-\infty, -\frac{1}{2}) \cup (-\frac{1}{2}, -\frac{1}{4}) \cup (-\frac{1}{4}, \infty)$

24. For $f(x) = \frac{2x}{x^2-4}$ and $g(x) = \sqrt{1-x}$

- $(g \circ f)(x) = \sqrt{\frac{x^2-2x-4}{x^2-4}}$, domain: $(-\infty, -2) \cup [1 - \sqrt{5}, 2) \cup [1 + \sqrt{5}, \infty)$
- $(f \circ g)(x) = -\frac{2\sqrt{1-x}}{x+3}$, domain: $(-\infty, -3) \cup (-3, 1]$
- $(f \circ f)(x) = \frac{4x-x^3}{x^4-9x^2+16}$, domain: $(-\infty, -\frac{1+\sqrt{17}}{2}) \cup (-\frac{1+\sqrt{17}}{2}, -2) \cup (-2, \frac{1-\sqrt{17}}{2}) \cup (\frac{1-\sqrt{17}}{2}, -\frac{1+\sqrt{17}}{2}) \cup (-\frac{1+\sqrt{17}}{2}, 2) \cup (2, \frac{1+\sqrt{17}}{2}) \cup (\frac{1+\sqrt{17}}{2}, \infty)$

25. $(h \circ g \circ f)(x) = |\sqrt{-2x}| = \sqrt{-2x}$, domain: $(-\infty, 0]$

26. $(h \circ f \circ g)(x) = |-2\sqrt{x}| = 2\sqrt{x}$, domain: $[0, \infty)$

27. $(g \circ f \circ h)(x) = \sqrt{-2|x|}$, domain: $\{0\}$

28. $(g \circ h \circ f)(x) = \sqrt{|-2x|} = \sqrt{2|x|}$, domain: $(-\infty, \infty)$

29. $(f \circ h \circ g)(x) = -2|\sqrt{x}| = -2\sqrt{x}$, domain: $[0, \infty)$

30. $(f \circ g \circ h)(x) = -2\sqrt{|x|}$, domain: $(-\infty, \infty)$
31. Let $f(x) = 2x + 3$ and $g(x) = x^3$, then $p(x) = (g \circ f)(x)$.
32. Let $f(x) = x^2 - x + 1$ and $g(x) = x^5$, $P(x) = (g \circ f)(x)$.
33. Let $f(x) = 2x - 1$ and $g(x) = \sqrt{x}$, then $h(x) = (g \circ f)(x)$.
34. Let $f(x) = 7 - 3x$ and $g(x) = |x|$, then $H(x) = (g \circ f)(x)$.
35. Let $f(x) = 5x + 1$ and $g(x) = \frac{2}{x}$, then $r(x) = (g \circ f)(x)$.
36. Let $f(x) = x^2 - 1$ and $g(x) = \frac{7}{x}$, then $R(x) = (g \circ f)(x)$.
37. Let $f(x) = |x|$ and $g(x) = \frac{x+1}{x-1}$, then $q(x) = (g \circ f)(x)$.
38. Let $f(x) = x^3$ and $g(x) = \frac{2x+1}{x-1}$, then $Q(x) = (g \circ f)(x)$.
39. Let $f(x) = 2x$ and $g(x) = \frac{x+1}{3-2x}$, then $v(x) = (g \circ f)(x)$.
40. Let $f(x) = x^2$ and $g(x) = \frac{x}{x^2+1}$, then $w(x) = (g \circ f)(x)$.
41. $F(x) = \sqrt{\frac{x^3+6}{x^3-9}} = (h(g(f(x))))$ where $f(x) = x^3$, $g(x) = \frac{x+6}{x-9}$ and $h(x) = \sqrt{x}$.
42. $F(x) = 3\sqrt{-x+2} - 4 = k(j(f(h(g(x)))))$
43. One possible solution is $F(x) = -\frac{1}{2}(2x-7)^3 + 1 = k(j(f(h(g(x)))))$ where $g(x) = 2x$, $h(x) = x - 7$, $j(x) = -\frac{1}{2}x$ and $k(x) = x + 1$. You could also have $F(x) = H(f(G(x)))$ where $G(x) = 2x - 7$ and $H(x) = -\frac{1}{2}x + 1$.
44. $(f \circ g)(3) = f(g(3)) = f(2) = 4$
45. $f(g(-1)) = f(-4)$ which is undefined
46. $(f \circ f)(0) = f(f(0)) = f(1) = 3$
47. $(f \circ g)(-3) = f(g(-3)) = f(-2) = 2$
48. $(g \circ f)(3) = g(f(3)) = g(-1) = -4$
49. $g(f(-3)) = g(4)$ which is undefined
50. $(g \circ g)(-2) = g(g(-2)) = g(0) = 0$
51. $(g \circ f)(-2) = g(f(-2)) = g(2) = 1$
52. $g(f(g(0))) = g(f(0)) = g(1) = -3$
53. $f(f(f(-1))) = f(f(0)) = f(1) = 3$
54. $f(f(f(f(f(1)))))) = f(f(f(f(3)))) = f(f(f(-1))) = f(f(0)) = f(1) = 3$
55. $\underbrace{(g \circ g \circ \dots \circ g)}_{n \text{ times}}(0) = 0$

56. $(g \circ f)(1) = 3$

57. $(f \circ g)(3) = 4$

58. $(g \circ f)(2) = 0$

59. $(f \circ g)(0) = 4$

60. $(f \circ f)(1) = 3$

61. $(g \circ g)(1) = 0$

62. $V(x) = x^3$ so $V(x(t)) = (t + 1)^3$

63. (a) $R(x) = 2x$

(b) $(R \circ x)(t) = -8t^2 + 40t + 184$, $0 \leq t \leq 4$. This gives the revenue per hour as a function of time.

(c) Noon corresponds to $t = 2$, so $(R \circ x)(2) = 232$. The hourly revenue at noon is \$232 per hour.

5.2 INVERSE FUNCTIONS

Thinking of a function as a process like we did in Section 1.4, in this section we seek another function which might reverse that process. As in real life, we will find that some processes (like putting on socks and shoes) are reversible while some (like cooking a steak) are not. We start by discussing a very basic function which is reversible, $f(x) = 3x + 4$. Thinking of f as a process, we start with an input x and apply two steps, as we saw in Section 1.4

1. multiply by 3
2. add 4

To reverse this process, we seek a function g which will undo each of these steps and take the output from f , $3x + 4$, and return the input x . If we think of the real-world reversible two-step process of first putting on socks then putting on shoes, to reverse the process, we first take off the shoes, and then we take off the socks. In much the same way, the function g should undo the second step of f first. That is, the function g should

1. *subtract* 4
2. *divide* by 3

Following this procedure, we get $g(x) = \frac{x-4}{3}$. Let's check to see if the function g does the job. If $x = 5$, then $f(5) = 3(5) + 4 = 15 + 4 = 19$. Taking the output 19 from f , we substitute it into g to get $g(19) = \frac{19-4}{3} = \frac{15}{3} = 5$, which is our original input to f . To check that g does the job for all x in the domain of f , we take the generic output from f , $f(x) = 3x + 4$, and substitute that into g . That is, $g(f(x)) = g(3x + 4) = \frac{(3x+4)-4}{3} = \frac{3x}{3} = x$, which is our original input to f . If we carefully examine the arithmetic as we simplify $g(f(x))$, we actually see g first 'undoing' the addition of 4, and then 'undoing' the multiplication by 3. Not only does g undo f , but f also undoes g . That is, if we take the output from g , $g(x) = \frac{x-4}{3}$, and put that into f , we get $f(g(x)) = f\left(\frac{x-4}{3}\right) = 3\left(\frac{x-4}{3}\right) + 4 = (x-4) + 4 = x$. Using the language of function composition developed in Section 5.1, the statements $g(f(x)) = x$ and $f(g(x)) = x$ can be written as $(g \circ f)(x) = x$ and $(f \circ g)(x) = x$, respectively. Abstractly, we can visualize the relationship between f and g in the diagram below.

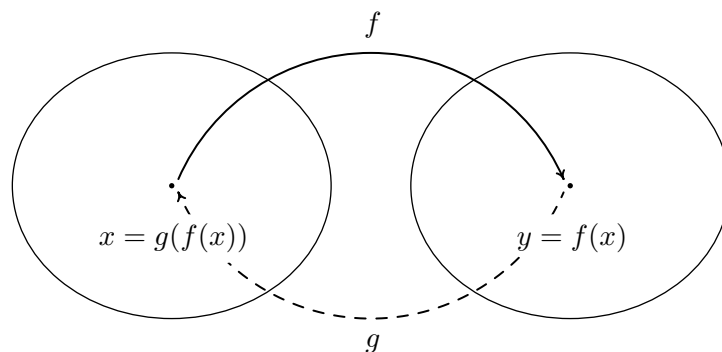

The main idea to get from the diagram is that g takes the outputs from f and returns them to their respective inputs, and conversely, f takes outputs from g and returns them to their respective inputs. We now have enough background to state the central definition of the section.

Definition 5.2. Suppose f and g are two functions such that

1. $(g \circ f)(x) = x$ for all x in the domain of f **and**
2. $(f \circ g)(x) = x$ for all x in the domain of g

then f and g are **inverses** of each other and the functions f and g are said to be **invertible**.

We now formalize the concept that inverse functions exchange inputs and outputs.

Theorem 5.2. Properties of Inverse Functions: Suppose f and g are inverse functions.

- The range^a of f is the domain of g and the domain of f is the range of g
- $f(a) = b$ if and only if $g(b) = a$
- (a, b) is on the graph of f if and only if (b, a) is on the graph of g

^aRecall this is the set of all outputs of a function.

Theorem 5.2 is a consequence of Definition 5.2 and the Fundamental Graphing Principle for Functions. We note the third property in Theorem 5.2 tells us that the graphs of inverse functions are reflections about the line $y = x$. For a proof of this, see Example 1.1.7 in Section 1.1 and Exercise 72 in Section 2.1. For example, we plot the inverse functions $f(x) = 3x + 4$ and $g(x) = \frac{x-4}{3}$ below.

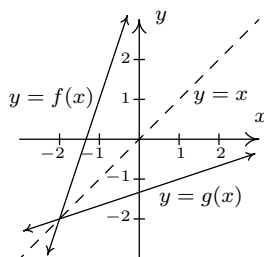

If we abstract one step further, we can express the sentiment in Definition 5.2 by saying that f and g are inverses if and only if $g \circ f = I_1$ and $f \circ g = I_2$ where I_1 is the identity function restricted¹ to the domain of f and I_2 is the identity function restricted to the domain of g . In other words, $I_1(x) = x$ for all x in the domain of f and $I_2(x) = x$ for all x in the domain of g . Using this description of inverses along with the properties of function composition listed in Theorem 5.1, we can show that function inverses are unique.² Suppose g and h are both inverses of a function

¹The identity function I , which was introduced in Section 2.1 and mentioned in Theorem 5.1, has a domain of all real numbers. Since the domains of f and g may not be all real numbers, we need the restrictions listed here.

²In other words, invertible functions have exactly one inverse.

f . By Theorem 5.2, the domain of g is equal to the domain of h , since both are the range of f . This means the identity function I_2 applies both to the domain of h and the domain of g . Thus $h = h \circ I_2 = h \circ (f \circ g) = (h \circ f) \circ g = I_1 \circ g = g$, as required.³ We summarize the discussion of the last two paragraphs in the following theorem.⁴

Theorem 5.3. Uniqueness of Inverse Functions and Their Graphs : Suppose f is an invertible function.

- There is exactly one inverse function for f , denoted f^{-1} (read f -inverse)
- The graph of $y = f^{-1}(x)$ is the reflection of the graph of $y = f(x)$ across the line $y = x$.

The notation f^{-1} is an unfortunate choice since you've been programmed since Elementary Algebra to think of this as $\frac{1}{f}$. This is most definitely *not* the case since, for instance, $f(x) = 3x + 4$ has as its inverse $f^{-1}(x) = \frac{x-4}{3}$, which is certainly different than $\frac{1}{f(x)} = \frac{1}{3x+4}$. Why does this confusing notation persist? As we mentioned in Section 5.1, the identity function I is to function composition what the real number 1 is to real number multiplication. The choice of notation f^{-1} alludes to the property that $f^{-1} \circ f = I_1$ and $f \circ f^{-1} = I_2$, in much the same way as $3^{-1} \cdot 3 = 1$ and $3 \cdot 3^{-1} = 1$.

Let's turn our attention to the function $f(x) = x^2$. Is f invertible? A likely candidate for the inverse is the function $g(x) = \sqrt{x}$. Checking the composition yields $(g \circ f)(x) = g(f(x)) = \sqrt{x^2} = |x|$, which is not equal to x for all x in the domain $(-\infty, \infty)$. For example, when $x = -2$, $f(-2) = (-2)^2 = 4$, but $g(4) = \sqrt{4} = 2$, which means g failed to return the input -2 from its output 4. What g did, however, is match the output 4 to a *different* input, namely 2, which satisfies $f(2) = 4$. This issue is presented schematically in the picture below.

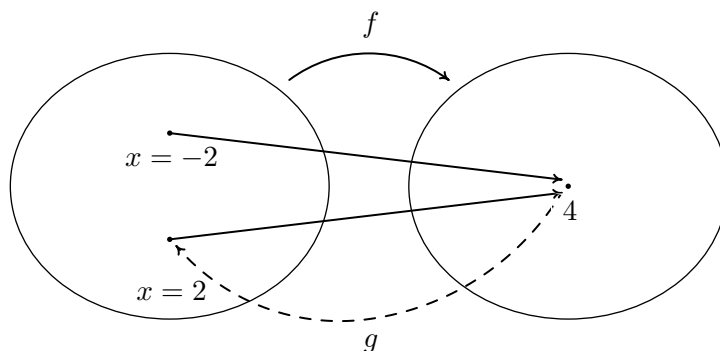

We see from the diagram that since both $f(-2)$ and $f(2)$ are 4, it is impossible to construct a *function* which takes 4 back to *both* $x = 2$ and $x = -2$. (By definition, a function matches a real number with exactly one other real number.) From a graphical standpoint, we know that if

³It is an excellent exercise to explain each step in this string of equalities.

⁴In the interests of full disclosure, the authors would like to admit that much of the discussion in the previous paragraphs could have easily been avoided had we appealed to the description of a function as a set of ordered pairs. We make no apology for our discussion from a function composition standpoint, however, since it exposes the reader to more abstract ways of thinking of functions and inverses. We will revisit this concept again in Chapter 7.

$y = f^{-1}(x)$ exists, its graph can be obtained by reflecting $y = x^2$ about the line $y = x$, in accordance with Theorem 5.3. Doing so produces

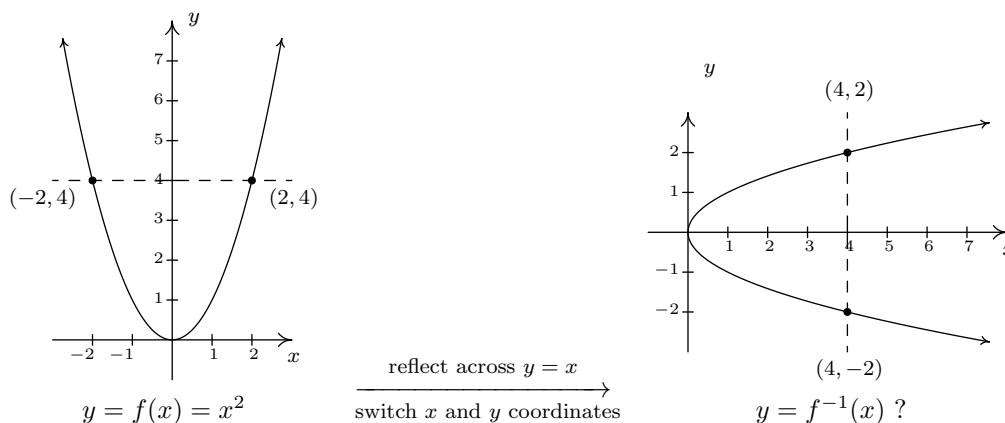

We see that the line $x = 4$ intersects the graph of the supposed inverse twice - meaning the graph fails the Vertical Line Test, Theorem 1.1, and as such, does not represent y as a function of x . The vertical line $x = 4$ on the graph on the right corresponds to the *horizontal line* $y = 4$ on the graph of $y = f(x)$. The fact that the horizontal line $y = 4$ intersects the graph of f twice means two *different* inputs, namely $x = -2$ and $x = 2$, are matched with the *same* output, 4, which is the cause of all of the trouble. In general, for a function to have an inverse, *different* inputs must go to *different* outputs, or else we will run into the same problem we did with $f(x) = x^2$. We give this property a name.

Definition 5.3. A function f is said to be **one-to-one** if f matches different inputs to different outputs. Equivalently, f is one-to-one if and only if whenever $f(c) = f(d)$, then $c = d$.

Graphically, we detect one-to-one functions using the test below.

Theorem 5.4. The Horizontal Line Test: A function f is one-to-one if and only if no horizontal line intersects the graph of f more than once.

We say that the graph of a function **passes** the Horizontal Line Test if no horizontal line intersects the graph more than once; otherwise, we say the graph of the function **fails** the Horizontal Line Test. We have argued that if f is invertible, then f must be one-to-one, otherwise the graph given by reflecting the graph of $y = f(x)$ about the line $y = x$ will fail the Vertical Line Test. It turns out that being one-to-one is also enough to guarantee invertibility. To see this, we think of f as the set of ordered pairs which constitute its graph. If switching the x - and y -coordinates of the points results in a function, then f is invertible and we have found f^{-1} . This is precisely what the Horizontal Line Test does for us: it checks to see whether or not a set of points describes x as a function of y . We summarize these results below.

Theorem 5.5. Equivalent Conditions for Invertibility: Suppose f is a function. The following statements are equivalent.

- f is invertible
- f is one-to-one
- The graph of f passes the Horizontal Line Test

We put this result to work in the next example.

Example 5.2.1. Determine if the following functions are one-to-one in two ways: (a) analytically using Definition 5.3 and (b) graphically using the Horizontal Line Test.

$$1. f(x) = \frac{1 - 2x}{5}$$

$$2. g(x) = \frac{2x}{1 - x}$$

$$3. h(x) = x^2 - 2x + 4$$

$$4. F = \{(-1, 1), (0, 2), (2, 1)\}$$

Solution.

1. (a) To determine if f is one-to-one analytically, we assume $f(c) = f(d)$ and attempt to deduce that $c = d$.

$$\begin{aligned} f(c) &= f(d) \\ \frac{1 - 2c}{5} &= \frac{1 - 2d}{5} \\ 1 - 2c &= 1 - 2d \\ -2c &= -2d \\ c &= d \checkmark \end{aligned}$$

Hence, f is one-to-one.

- (b) To check if f is one-to-one graphically, we look to see if the graph of $y = f(x)$ passes the Horizontal Line Test. We have that f is a non-constant linear function, which means its graph is a non-horizontal line. Thus the graph of f passes the Horizontal Line Test.

2. (a) We begin with the assumption that $g(c) = g(d)$ and try to show $c = d$.

$$\begin{aligned} g(c) &= g(d) \\ \frac{2c}{1 - c} &= \frac{2d}{1 - d} \\ 2c(1 - d) &= 2d(1 - c) \\ 2c - 2cd &= 2d - 2dc \\ 2c &= 2d \\ c &= d \checkmark \end{aligned}$$

We have shown that g is one-to-one.

- (b) We can graph g using the six step procedure outlined in Section 4.2. We get the sole intercept at $(0,0)$, a vertical asymptote $x = 1$ and a horizontal asymptote (which the graph never crosses) $y = -2$. We see from that the graph of g passes the Horizontal Line Test.

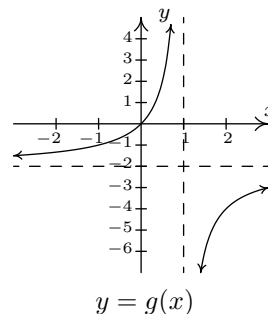
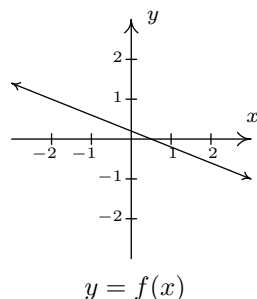

3. (a) We begin with $h(c) = h(d)$. As we work our way through the problem, we encounter a nonlinear equation. We move the non-zero terms to the left, leave a 0 on the right and factor accordingly.

$$\begin{aligned}
 h(c) &= h(d) \\
 c^2 - 2c + 4 &= d^2 - 2d + 4 \\
 c^2 - 2c &= d^2 - 2d \\
 c^2 - d^2 - 2c + 2d &= 0 \\
 (c + d)(c - d) - 2(c - d) &= 0 \\
 (c - d)((c + d) - 2) &= 0 && \text{factor by grouping} \\
 c - d = 0 &\text{ or } c + d - 2 = 0 \\
 c = d &\text{ or } c = 2 - d
 \end{aligned}$$

We get $c = d$ as one possibility, but we also get the possibility that $c = 2 - d$. This suggests that f may not be one-to-one. Taking $d = 0$, we get $c = 0$ or $c = 2$. With $f(0) = 4$ and $f(2) = 4$, we have produced two different inputs with the same output meaning f is not one-to-one.

- (b) We note that h is a quadratic function and we graph $y = h(x)$ using the techniques presented in Section 2.3. The vertex is $(1, 3)$ and the parabola opens upwards. We see immediately from the graph that h is not one-to-one, since there are several horizontal lines which cross the graph more than once.
4. (a) The function F is given to us as a set of ordered pairs. The condition $F(c) = F(d)$ means the outputs from the function (the y -coordinates of the ordered pairs) are the same. We see that the points $(-1, 1)$ and $(2, 1)$ are both elements of F with $F(-1) = 1$ and $F(2) = 1$. Since $-1 \neq 2$, we have established that F is *not* one-to-one.
- (b) Graphically, we see the horizontal line $y = 1$ crosses the graph more than once. Hence, the graph of F fails the Horizontal Line Test.

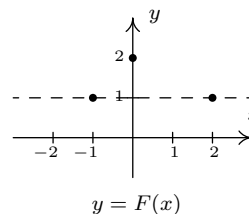
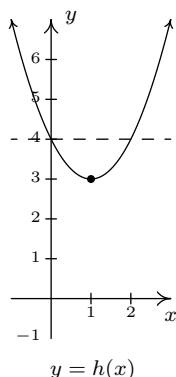

□

We have shown that the functions f and g in Example 5.2.1 are one-to-one. This means they are invertible, so it is natural to wonder what $f^{-1}(x)$ and $g^{-1}(x)$ would be. For $f(x) = \frac{1-2x}{5}$, we can think our way through the inverse since there is only one occurrence of x . We can track step-by-step what is done to x and reverse those steps as we did at the beginning of the chapter. The function $g(x) = \frac{2x}{1-x}$ is a bit trickier since x occurs in two places. When one evaluates $g(x)$ for a specific value of x , which is first, the $2x$ or the $1-x$? We can imagine functions more complicated than these so we need to develop a general methodology to attack this problem. Theorem 5.2 tells us equation $y = f^{-1}(x)$ is equivalent to $f(y) = x$ and this is the basis of our algorithm.

Steps for finding the Inverse of a One-to-one Function

1. Write $y = f(x)$
2. Interchange x and y
3. Solve $x = f(y)$ for y to obtain $y = f^{-1}(x)$

Note that we could have simply written ‘Solve $x = f(y)$ for y ’ and be done with it. The act of interchanging the x and y is there to remind us that we are finding the inverse function by switching the inputs and outputs.

Example 5.2.2. Find the inverse of the following one-to-one functions. Check your answers analytically using function composition and graphically.

1. $f(x) = \frac{1-2x}{5}$

2. $g(x) = \frac{2x}{1-x}$

Solution.

1. As we mentioned earlier, it is possible to think our way through the inverse of f by recording the steps we apply to x and the order in which we apply them and then reversing those steps in the reverse order. We encourage the reader to do this. We, on the other hand, will practice the algorithm. We write $y = f(x)$ and proceed to switch x and y

$$\begin{aligned}
 y &= f(x) \\
 y &= \frac{1-2x}{5} \\
 x &= \frac{1-2y}{5} && \text{switch } x \text{ and } y \\
 5x &= 1-2y \\
 5x-1 &= -2y \\
 \frac{5x-1}{-2} &= y \\
 y &= -\frac{5}{2}x + \frac{1}{2}
 \end{aligned}$$

We have $f^{-1}(x) = -\frac{5}{2}x + \frac{1}{2}$. To check this answer analytically, we first check that $(f^{-1} \circ f)(x) = x$ for all x in the domain of f , which is all real numbers.

$$\begin{aligned}
 (f^{-1} \circ f)(x) &= f^{-1}(f(x)) \\
 &= -\frac{5}{2}f(x) + \frac{1}{2} \\
 &= -\frac{5}{2}\left(\frac{1-2x}{5}\right) + \frac{1}{2} \\
 &= -\frac{1}{2}(1-2x) + \frac{1}{2} \\
 &= -\frac{1}{2} + x + \frac{1}{2} \\
 &= x \checkmark
 \end{aligned}$$

We now check that $(f \circ f^{-1})(x) = x$ for all x in the range of f which is also all real numbers. (Recall that the domain of f^{-1} is the range of f .)

$$\begin{aligned}
 (f \circ f^{-1})(x) &= f(f^{-1}(x)) \\
 &= \frac{1-2f^{-1}(x)}{5} \\
 &= \frac{1-2\left(-\frac{5}{2}x + \frac{1}{2}\right)}{5} \\
 &= \frac{1+5x-1}{5} \\
 &= \frac{5x}{5} \\
 &= x \checkmark
 \end{aligned}$$

To check our answer graphically, we graph $y = f(x)$ and $y = f^{-1}(x)$ on the same set of axes.⁵ They appear to be reflections across the line $y = x$.

⁵Note that if you perform your check on a calculator for more sophisticated functions, you'll need to take advantage of the 'ZoomSquare' feature to get the correct geometric perspective.

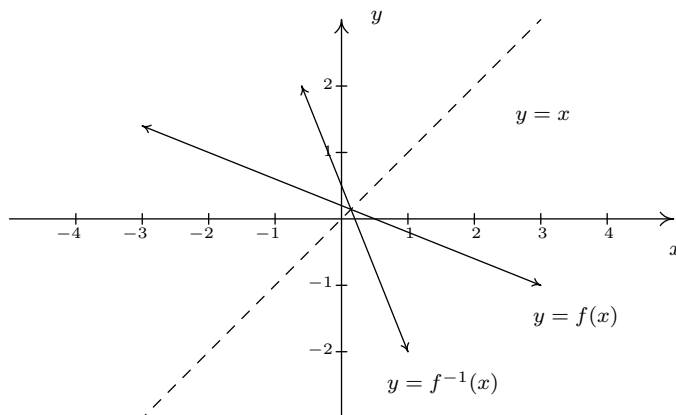

2. To find $g^{-1}(x)$, we start with $y = g(x)$. We note that the domain of g is $(-\infty, 1) \cup (1, \infty)$.

$$\begin{aligned}
 y &= g(x) \\
 y &= \frac{2x}{1-x} \\
 x &= \frac{2y}{1-y} && \text{switch } x \text{ and } y \\
 x(1-y) &= 2y \\
 x - xy &= 2y \\
 x &= xy + 2y \\
 x &= y(x+2) && \text{factor} \\
 y &= \frac{x}{x+2}
 \end{aligned}$$

We obtain $g^{-1}(x) = \frac{x}{x+2}$. To check this analytically, we first check $(g^{-1} \circ g)(x) = x$ for all x in the domain of g , that is, for all $x \neq 1$.

$$\begin{aligned}
 (g^{-1} \circ g)(x) &= g^{-1}(g(x)) \\
 &= g^{-1}\left(\frac{2x}{1-x}\right) \\
 &= \frac{\left(\frac{2x}{1-x}\right)}{\left(\frac{2x}{1-x}\right) + 2} \\
 &= \frac{\left(\frac{2x}{1-x}\right)}{\left(\frac{2x}{1-x}\right) + 2} \cdot \frac{(1-x)}{(1-x)} && \text{clear denominators}
 \end{aligned}$$

$$\begin{aligned}
&= \frac{2x}{2x + 2(1 - x)} \\
&= \frac{2x}{2x + 2 - 2x} \\
&= \frac{2x}{2} \\
&= x \checkmark
\end{aligned}$$

Next, we check $g(g^{-1}(x)) = x$ for all x in the range of g . From the graph of g in Example 5.2.1, we have that the range of g is $(-\infty, -2) \cup (-2, \infty)$. This matches the domain we get from the formula $g^{-1}(x) = \frac{x}{x+2}$, as it should.

$$\begin{aligned}
(g \circ g^{-1})(x) &= g(g^{-1}(x)) \\
&= g\left(\frac{x}{x+2}\right) \\
&= \frac{2\left(\frac{x}{x+2}\right)}{1 - \left(\frac{x}{x+2}\right)} \\
&= \frac{2\left(\frac{x}{x+2}\right)}{1 - \left(\frac{x}{x+2}\right)} \cdot \frac{(x+2)}{(x+2)} \quad \text{clear denominators} \\
&= \frac{2x}{(x+2) - x} \\
&= \frac{2x}{2} \\
&= x \checkmark
\end{aligned}$$

Graphing $y = g(x)$ and $y = g^{-1}(x)$ on the same set of axes is busy, but we can see the symmetric relationship if we thicken the curve for $y = g^{-1}(x)$. Note that the vertical asymptote $x = 1$ of the graph of g corresponds to the horizontal asymptote $y = 1$ of the graph of g^{-1} , as it should since x and y are switched. Similarly, the horizontal asymptote $y = -2$ of the graph of g corresponds to the vertical asymptote $x = -2$ of the graph of g^{-1} .

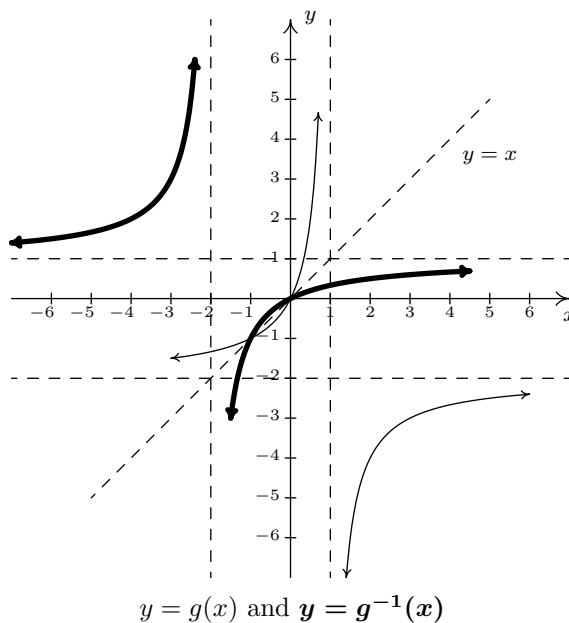

□

We now return to $f(x) = x^2$. We know that f is not one-to-one, and thus, is not invertible. However, if we restrict the domain of f , we can produce a new function g which is one-to-one. If we define $g(x) = x^2, x \geq 0$, then we have

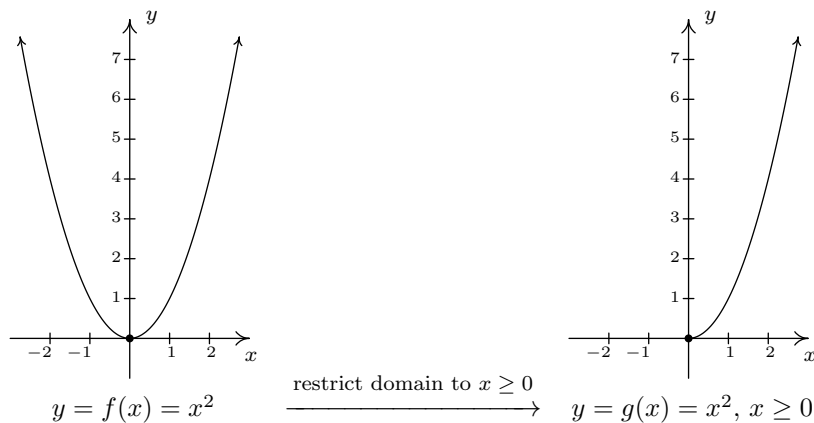

The graph of g passes the Horizontal Line Test. To find an inverse of g , we proceed as usual

$$\begin{aligned}
 y &= g(x) \\
 y &= x^2, \quad x \geq 0 \\
 x &= y^2, \quad y \geq 0 \quad \text{switch } x \text{ and } y \\
 y &= \pm\sqrt{x} \\
 y &= \sqrt{x} \qquad \qquad \qquad \text{since } y \geq 0
 \end{aligned}$$

We get $g^{-1}(x) = \sqrt{x}$. At first it looks like we'll run into the same trouble as before, but when we check the composition, the domain restriction on g saves the day. We get $(g^{-1} \circ g)(x) = g^{-1}(g(x)) = g^{-1}(x^2) = \sqrt{x^2} = |x| = x$, since $x \geq 0$. Checking $(g \circ g^{-1})(x) = g(g^{-1}(x)) = g(\sqrt{x}) = (\sqrt{x})^2 = x$. Graphing⁶ g and g^{-1} on the same set of axes shows that they are reflections about the line $y = x$.

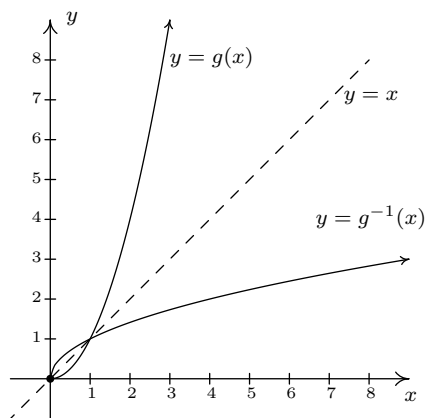

Our next example continues the theme of domain restriction.

Example 5.2.3. Graph the following functions to show they are one-to-one and find their inverses. Check your answers analytically using function composition and graphically.

1. $j(x) = x^2 - 2x + 4, x \leq 1$.

2. $k(x) = \sqrt{x+2} - 1$

Solution.

- The function j is a restriction of the function h from Example 5.2.1. Since the domain of j is restricted to $x \leq 1$, we are selecting only the 'left half' of the parabola. We see that the graph of j passes the Horizontal Line Test and thus j is invertible.

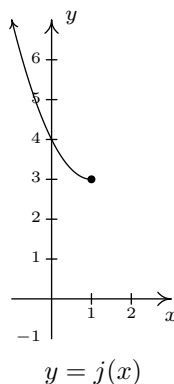

⁶We graphed $y = \sqrt{x}$ in Section 1.7.

We now use our algorithm⁷ to find $j^{-1}(x)$.

$$\begin{aligned}
 y &= j(x) \\
 y &= x^2 - 2x + 4, \quad x \leq 1 \\
 x &= y^2 - 2y + 4, \quad y \leq 1 && \text{switch } x \text{ and } y \\
 0 &= y^2 - 2y + 4 - x \\
 y &= \frac{2 \pm \sqrt{(-2)^2 - 4(1)(4-x)}}{2(1)} && \text{quadratic formula, } c = 4 - x \\
 y &= \frac{2 \pm \sqrt{4x - 12}}{2} \\
 y &= \frac{2 \pm \sqrt{4(x-3)}}{2} \\
 y &= \frac{2 \pm 2\sqrt{x-3}}{2} \\
 y &= \frac{2(1 \pm \sqrt{x-3})}{2} \\
 y &= 1 \pm \sqrt{x-3} \\
 y &= 1 - \sqrt{x-3} && \text{since } y \leq 1.
 \end{aligned}$$

We have $j^{-1}(x) = 1 - \sqrt{x-3}$. When we simplify $(j^{-1} \circ j)(x)$, we need to remember that the domain of j is $x \leq 1$.

$$\begin{aligned}
 (j^{-1} \circ j)(x) &= j^{-1}(j(x)) \\
 &= j^{-1}(x^2 - 2x + 4), \quad x \leq 1 \\
 &= 1 - \sqrt{(x^2 - 2x + 4) - 3} \\
 &= 1 - \sqrt{x^2 - 2x + 1} \\
 &= 1 - \sqrt{(x-1)^2} \\
 &= 1 - |x-1| \\
 &= 1 - (-(x-1)) && \text{since } x \leq 1 \\
 &= x \checkmark
 \end{aligned}$$

Checking $j \circ j^{-1}$, we get

$$\begin{aligned}
 (j \circ j^{-1})(x) &= j(j^{-1}(x)) \\
 &= j(1 - \sqrt{x-3}) \\
 &= (1 - \sqrt{x-3})^2 - 2(1 - \sqrt{x-3}) + 4 \\
 &= 1 - 2\sqrt{x-3} + (\sqrt{x-3})^2 - 2 + 2\sqrt{x-3} + 4 \\
 &= 3 + x - 3 \\
 &= x \checkmark
 \end{aligned}$$

⁷Here, we use the Quadratic Formula to solve for y . For ‘completeness,’ we note you can (and should!) also consider solving for y by ‘completing’ the square.

Using what we know from Section 1.7, we graph $y = j^{-1}(x)$ and $y = j(x)$ below.

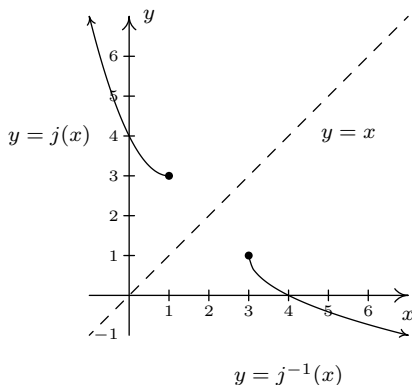

2. We graph $y = k(x) = \sqrt{x+2} - 1$ using what we learned in Section 1.7 and see k is one-to-one.

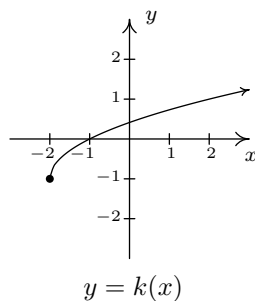

We now try to find k^{-1} .

$$\begin{aligned}
 y &= k(x) \\
 y &= \sqrt{x+2} - 1 \\
 x &= \sqrt{y+2} - 1 \quad \text{switch } x \text{ and } y \\
 x+1 &= \sqrt{y+2} \\
 (x+1)^2 &= (\sqrt{y+2})^2 \\
 x^2 + 2x + 1 &= y + 2 \\
 y &= x^2 + 2x - 1
 \end{aligned}$$

We have $k^{-1}(x) = x^2 + 2x - 1$. Based on our experience, we know something isn't quite right. We determined k^{-1} is a quadratic function, and we have seen several times in this section that these are not one-to-one unless their domains are suitably restricted. Theorem 5.2 tells us that the domain of k^{-1} is the range of k . From the graph of k , we see that the range is $[-1, \infty)$, which means we restrict the domain of k^{-1} to $x \geq -1$. We now check that this works in our compositions.

$$\begin{aligned}
(k^{-1} \circ k)(x) &= k^{-1}(k(x)) \\
&= k^{-1}(\sqrt{x+2}-1), \quad x \geq -2 \\
&= (\sqrt{x+2}-1)^2 + 2(\sqrt{x+2}-1) - 1 \\
&= (\sqrt{x+2})^2 - 2\sqrt{x+2} + 1 + 2\sqrt{x+2} - 2 - 1 \\
&= x + 2 - 2 \\
&= x \quad \checkmark
\end{aligned}$$

and

$$\begin{aligned}
(k \circ k^{-1})(x) &= k(x^2 + 2x - 1) \quad x \geq -1 \\
&= \sqrt{(x^2 + 2x - 1) + 2} - 1 \\
&= \sqrt{x^2 + 2x + 1} - 1 \\
&= \sqrt{(x+1)^2} - 1 \\
&= |x+1| - 1 \\
&= x + 1 - 1 \quad \text{since } x \geq -1 \\
&= x \quad \checkmark
\end{aligned}$$

Graphically, everything checks out as well, provided that we remember the domain restriction on k^{-1} means we take the right half of the parabola.

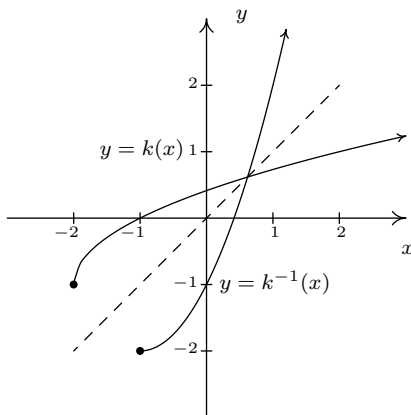

□

Our last example of the section gives an application of inverse functions.

Example 5.2.4. Recall from Section 2.1 that the price-demand equation for the PortaBoy game system is $p(x) = -1.5x + 250$ for $0 \leq x \leq 166$, where x represents the number of systems sold weekly and p is the price per system in dollars.

1. Explain why p is one-to-one and find a formula for $p^{-1}(x)$. State the restricted domain.
2. Find and interpret $p^{-1}(220)$.
3. Recall from Section 2.3 that the weekly profit P , in dollars, as a result of selling x systems is given by $P(x) = -1.5x^2 + 170x - 150$. Find and interpret $(P \circ p^{-1})(x)$.
4. Use your answer to part 3 to determine the price per PortaBoy which would yield the maximum profit. Compare with Example 2.3.3.

Solution.

1. We leave to the reader to show the graph of $p(x) = -1.5x + 250$, $0 \leq x \leq 166$, is a line segment from $(0, 250)$ to $(166, 1)$, and as such passes the Horizontal Line Test. Hence, p is one-to-one. We find the expression for $p^{-1}(x)$ as usual and get $p^{-1}(x) = \frac{500-2x}{3}$. The domain of p^{-1} should match the range of p , which is $[1, 250]$, and as such, we restrict the domain of p^{-1} to $1 \leq x \leq 250$.
2. We find $p^{-1}(220) = \frac{500-2(220)}{3} = 20$. Since the function p took as inputs the weekly sales and furnished the price per system as the output, p^{-1} takes the price per system and returns the weekly sales as its output. Hence, $p^{-1}(220) = 20$ means 20 systems will be sold in a week if the price is set at \$220 per system.
3. We compute $(P \circ p^{-1})(x) = P(p^{-1}(x)) = P\left(\frac{500-2x}{3}\right) = -1.5\left(\frac{500-2x}{3}\right)^2 + 170\left(\frac{500-2x}{3}\right) - 150$. After a hefty amount of Elementary Algebra,⁸ we obtain $(P \circ p^{-1})(x) = -\frac{2}{3}x^2 + 220x - \frac{40450}{3}$. To understand what this means, recall that the original profit function P gave us the weekly profit as a function of the weekly sales. The function p^{-1} gives us the weekly sales as a function of the price. Hence, $P \circ p^{-1}$ takes as its input a price. The function p^{-1} returns the weekly sales, which in turn is fed into P to return the weekly profit. Hence, $(P \circ p^{-1})(x)$ gives us the weekly profit (in dollars) as a function of the price per system, x , using the weekly sales $p^{-1}(x)$ as the ‘middle man’.
4. We know from Section 2.3 that the graph of $y = (P \circ p^{-1})(x)$ is a parabola opening downwards. The maximum profit is realized at the vertex. Since we are concerned only with the price per system, we need only find the x -coordinate of the vertex. Identifying $a = -\frac{2}{3}$ and $b = 220$, we get, by the Vertex Formula, Equation 2.4, $x = -\frac{b}{2a} = 165$. Hence, weekly profit is maximized if we set the price at \$165 per system. Comparing this with our answer from Example 2.3.3, there is a slight discrepancy to the tune of \$0.50. We leave it to the reader to balance the books appropriately. \square

⁸It is good review to actually do this!

5.2.1 EXERCISES

In Exercises 1 - 20, show that the given function is one-to-one and find its inverse. Check your answers algebraically and graphically. Verify that the range of f is the domain of f^{-1} and vice-versa.

1. $f(x) = 6x - 2$

2. $f(x) = 42 - x$

3. $f(x) = \frac{x-2}{3} + 4$

4. $f(x) = 1 - \frac{4+3x}{5}$

5. $f(x) = \sqrt{3x-1} + 5$

6. $f(x) = 2 - \sqrt{x-5}$

7. $f(x) = 3\sqrt{x-1} - 4$

8. $f(x) = 1 - 2\sqrt{2x+5}$

9. $f(x) = \sqrt[5]{3x-1}$

10. $f(x) = 3 - \sqrt[3]{x-2}$

11. $f(x) = x^2 - 10x, x \geq 5$

12. $f(x) = 3(x+4)^2 - 5, x \leq -4$

13. $f(x) = x^2 - 6x + 5, x \leq 3$

14. $f(x) = 4x^2 + 4x + 1, x < -1$

15. $f(x) = \frac{3}{4-x}$

16. $f(x) = \frac{x}{1-3x}$

17. $f(x) = \frac{2x-1}{3x+4}$

18. $f(x) = \frac{4x+2}{3x-6}$

19. $f(x) = \frac{-3x-2}{x+3}$

20. $f(x) = \frac{x-2}{2x-1}$

With help from your classmates, find the inverses of the functions in Exercises 21 - 24.

21. $f(x) = ax + b, a \neq 0$

22. $f(x) = a\sqrt{x-h} + k, a \neq 0, x \geq h$

23. $f(x) = ax^2 + bx + c$ where $a \neq 0, x \geq -\frac{b}{2a}$.

24. $f(x) = \frac{ax+b}{cx+d}$, (See Exercise 33 below.)

25. In Example 1.5.3, the price of a dOpi media player, in dollars per dOpi, is given as a function of the weekly sales x according to the formula $p(x) = 450 - 15x$ for $0 \leq x \leq 30$.

(a) Find $p^{-1}(x)$ and state its domain.

(b) Find and interpret $p^{-1}(105)$.

(c) In Example 1.5.3, we determined that the profit (in dollars) made from producing and selling x dOpis per week is $P(x) = -15x^2 + 350x - 2000$, for $0 \leq x \leq 30$. Find $(P \circ p^{-1})(x)$ and determine what price per dOpi would yield the maximum profit. What is the maximum profit? How many dOpis need to be produced and sold to achieve the maximum profit?

26. Show that the Fahrenheit to Celsius conversion function found in Exercise 35 in Section 2.1 is invertible and that its inverse is the Celsius to Fahrenheit conversion function.
27. Analytically show that the function $f(x) = x^3 + 3x + 1$ is one-to-one. Since finding a formula for its inverse is beyond the scope of this textbook, use Theorem 5.2 to help you compute $f^{-1}(1)$, $f^{-1}(5)$, and $f^{-1}(-3)$.
28. Let $f(x) = \frac{2x}{x^2-1}$. Using the techniques in Section 4.2, graph $y = f(x)$. Verify that f is one-to-one on the interval $(-1, 1)$. Use the procedure outlined on Page 518 and your graphing calculator to find the formula for $f^{-1}(x)$. Note that since $f(0) = 0$, it should be the case that $f^{-1}(0) = 0$. What goes wrong when you attempt to substitute $x = 0$ into $f^{-1}(x)$? Discuss with your classmates how this problem arose and possible remedies.
29. With the help of your classmates, explain why a function which is either strictly increasing or strictly decreasing on its entire domain would have to be one-to-one, hence invertible.
30. If f is odd and invertible, prove that f^{-1} is also odd.
31. Let f and g be invertible functions. With the help of your classmates show that $(f \circ g)$ is one-to-one, hence invertible, and that $(f \circ g)^{-1}(x) = (g^{-1} \circ f^{-1})(x)$.
32. What graphical feature must a function f possess for it to be its own inverse?
33. What conditions must you place on the values of a, b, c and d in Exercise 24 in order to guarantee that the function is invertible?

5.2.2 ANSWERS

1. $f^{-1}(x) = \frac{x+2}{6}$

2. $f^{-1}(x) = 42 - x$

3. $f^{-1}(x) = 3x - 10$

4. $f^{-1}(x) = -\frac{5}{3}x + \frac{1}{3}$

5. $f^{-1}(x) = \frac{1}{3}(x-5)^2 + \frac{1}{3}, x \geq 5$

6. $f^{-1}(x) = (x-2)^2 + 5, x \leq 2$

7. $f^{-1}(x) = \frac{1}{9}(x+4)^2 + 1, x \geq -4$

8. $f^{-1}(x) = \frac{1}{8}(x-1)^2 - \frac{5}{2}, x \leq 1$

9. $f^{-1}(x) = \frac{1}{3}x^5 + \frac{1}{3}$

10. $f^{-1}(x) = -(x-3)^3 + 2$

11. $f^{-1}(x) = 5 + \sqrt{x+25}$

12. $f^{-1}(x) = -\sqrt{\frac{x+5}{3}} - 4$

13. $f^{-1}(x) = 3 - \sqrt{x+4}$

14. $f^{-1}(x) = -\frac{\sqrt{x+1}}{2}, x > 1$

15. $f^{-1}(x) = \frac{4x-3}{x}$

16. $f^{-1}(x) = \frac{x}{3x+1}$

17. $f^{-1}(x) = \frac{4x+1}{2-3x}$

18. $f^{-1}(x) = \frac{6x+2}{3x-4}$

19. $f^{-1}(x) = \frac{-3x-2}{x+3}$

20. $f^{-1}(x) = \frac{x-2}{2x-1}$

25. (a) $p^{-1}(x) = \frac{450-x}{15}$. The domain of p^{-1} is the range of p which is $[0, 450]$ (b) $p^{-1}(105) = 23$. This means that if the price is set to \$105 then 23 dOpis will be sold.(c) $(P \circ p^{-1})(x) = -\frac{1}{15}x^2 + \frac{110}{3}x - 5000, 0 \leq x \leq 450$. The graph of $y = (P \circ p^{-1})(x)$ is a parabola opening downwards with vertex $(275, \frac{125}{3}) \approx (275, 41.67)$. This means that the maximum profit is a whopping \$41.67 when the price per dOpi is set to \$275. At this price, we can produce and sell $p^{-1}(275) = 11.\bar{6}$ dOpis. Since we cannot sell part of a system, we need to adjust the price to sell either 11 dOpis or 12 dOpis. We find $p(11) = 285$ and $p(12) = 270$, which means we set the price per dOpi at either \$285 or \$270, respectively. The profits at these prices are $(P \circ p^{-1})(285) = 35$ and $(P \circ p^{-1})(270) = 40$, so it looks as if the maximum profit is \$40 and it is made by producing and selling 12 dOpis a week at a price of \$270 per dOpi.27. Given that $f(0) = 1$, we have $f^{-1}(1) = 0$. Similarly $f^{-1}(5) = 1$ and $f^{-1}(-3) = -1$

5.3 OTHER ALGEBRAIC FUNCTIONS

This section serves as a watershed for functions which are combinations of polynomial, and more generally, rational functions, with the operations of radicals. It is business of Calculus to discuss these functions in all the detail they demand so our aim in this section is to help shore up the requisite skills needed so that the reader can answer Calculus's call when the time comes. We briefly recall the definition and some of the basic properties of radicals from Intermediate Algebra.¹

Definition 5.4. Let x be a real number and n a natural number.^a If n is odd, the **principal n^{th} root** of x , denoted $\sqrt[n]{x}$ is the unique real number satisfying $(\sqrt[n]{x})^n = x$. If n is even, $\sqrt[n]{x}$ is defined similarly^b provided $x \geq 0$ and $\sqrt[n]{x} \geq 0$. The **index** is the number n and the **radicand** is the number x . For $n = 2$, we write \sqrt{x} instead of $\sqrt[2]{x}$.

^aRecall this means $n = 1, 2, 3, \dots$

^bRecall both $x = -2$ and $x = 2$ satisfy $x^4 = 16$, but $\sqrt[4]{16} = 2$, not -2 .

It is worth remarking that, in light of Section 5.2, we could define $f(x) = \sqrt[n]{x}$ functionally as the inverse of $g(x) = x^n$ with the stipulation that when n is even, the domain of g is restricted to $[0, \infty)$. From what we know about $g(x) = x^n$ from Section 3.1 along with Theorem 5.3, we can produce the graphs of $f(x) = \sqrt[n]{x}$ by reflecting the graphs of $g(x) = x^n$ across the line $y = x$. Below are the graphs of $y = \sqrt{x}$, $y = \sqrt[4]{x}$ and $y = \sqrt[6]{x}$. The point $(0, 0)$ is indicated as a reference. The axes are hidden so we can see the vertical steepening near $x = 0$ and the horizontal flattening as $x \rightarrow \infty$.

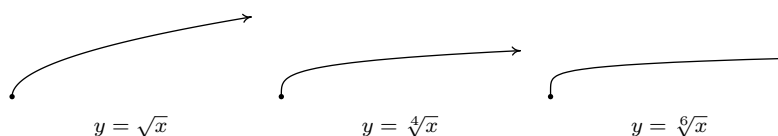

The odd-indexed radical functions also follow a predictable trend - steepening near $x = 0$ and flattening as $x \rightarrow \pm\infty$. In the exercises, you'll have a chance to graph some basic radical functions using the techniques presented in Section 1.7.

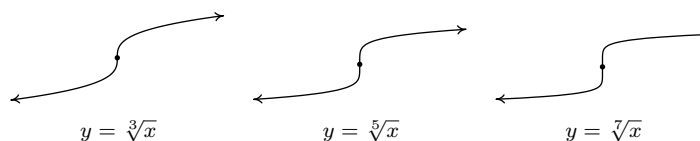

We have used all of the following properties at some point in the textbook for the case $n = 2$ (the square root), but we list them here in generality for completeness.

¹Although we discussed imaginary numbers in Section 3.4, we restrict our attention to real numbers in this section. See the epilogue on page 428 for more details.

Theorem 5.6. Properties of Radicals: Let x and y be real numbers and m and n be natural numbers. If $\sqrt[n]{x}$, $\sqrt[n]{y}$ are real numbers, then

- **Product Rule:** $\sqrt[n]{xy} = \sqrt[n]{x} \sqrt[n]{y}$
- **Powers of Radicals:** $\sqrt[n]{x^m} = (\sqrt[n]{x})^m$
- **Quotient Rule:** $\sqrt[n]{\frac{x}{y}} = \frac{\sqrt[n]{x}}{\sqrt[n]{y}}$, provided $y \neq 0$.
- If n is odd, $\sqrt[n]{x^n} = x$; if n is even, $\sqrt[n]{x^n} = |x|$.

The proof of Theorem 5.6 is based on the definition of the principal roots and properties of exponents. To establish the product rule, consider the following. If n is odd, then by definition $\sqrt[n]{xy}$ is the unique real number such that $(\sqrt[n]{xy})^n = xy$. Given that $(\sqrt[n]{x} \sqrt[n]{y})^n = (\sqrt[n]{x})^n (\sqrt[n]{y})^n = xy$, it must be the case that $\sqrt[n]{xy} = \sqrt[n]{x} \sqrt[n]{y}$. If n is even, then $\sqrt[n]{xy}$ is the unique non-negative real number such that $(\sqrt[n]{xy})^n = xy$. Also note that since n is even, $\sqrt[n]{x}$ and $\sqrt[n]{y}$ are also non-negative and hence so is $\sqrt[n]{x} \sqrt[n]{y}$. Proceeding as above, we find that $\sqrt[n]{xy} = \sqrt[n]{x} \sqrt[n]{y}$. The quotient rule is proved similarly and is left as an exercise. The power rule results from repeated application of the product rule, so long as $\sqrt[n]{x}$ is a real number to start with.² The last property is an application of the power rule when n is odd, and the occurrence of the absolute value when n is even is due to the requirement that $\sqrt[n]{x} \geq 0$ in Definition 5.4. For instance, $\sqrt[4]{(-2)^4} = \sqrt[4]{16} = 2 = |-2|$, not -2 . It's this last property which makes compositions of roots and powers delicate. This is especially true when we use exponential notation for radicals. Recall the following definition.

Definition 5.5. Let x be a real number, m an integer^a and n a natural number.

- $x^{\frac{1}{n}} = \sqrt[n]{x}$ and is defined whenever $\sqrt[n]{x}$ is defined.
- $x^{\frac{m}{n}} = (\sqrt[n]{x})^m = \sqrt[n]{x^m}$, whenever $(\sqrt[n]{x})^m$ is defined.

^aRecall this means $m = 0, \pm 1, \pm 2, \dots$

The rational exponents defined in Definition 5.5 behave very similarly to the usual integer exponents from Elementary Algebra with one critical exception. Consider the expression $(x^{2/3})^{3/2}$. Applying the usual laws of exponents, we'd be tempted to simplify this as $(x^{2/3})^{3/2} = x^{\frac{2}{3} \cdot \frac{3}{2}} = x^1 = x$. However, if we substitute $x = -1$ and apply Definition 5.5, we find $(-1)^{2/3} = (\sqrt[3]{-1})^2 = (-1)^2 = 1$ so that $((-1)^{2/3})^{3/2} = 1^{3/2} = (\sqrt{1})^3 = 1^3 = 1$. We see in this case that $(x^{2/3})^{3/2} \neq x$. If we take the time to rewrite $(x^{2/3})^{3/2}$ with radicals, we see

$$(x^{2/3})^{3/2} = ((\sqrt[3]{x})^2)^{3/2} = \left(\sqrt{(\sqrt[3]{x})^2}\right)^3 = (|\sqrt[3]{x}|)^3 = |(\sqrt[3]{x})^3| = |x|$$

²Otherwise we'd run into the same paradox we did in Section 3.4.

In the play-by-play analysis, we see that when we canceled the 2's in multiplying $\frac{2}{3} \cdot \frac{3}{2}$, we were, in fact, attempting to cancel a square with a square root. The fact that $\sqrt{x^2} = |x|$ and not simply x is the root³ of the trouble. It may amuse the reader to know that $(x^{3/2})^{2/3} = x$, and this verification is left as an exercise. The moral of the story is that when simplifying fractional exponents, it's usually best to rewrite them as radicals.⁴ The last major property we will state, and leave to Calculus to prove, is that radical functions are continuous on their domains, so the Intermediate Value Theorem, Theorem 3.1, applies. This means that if we take combinations of radical functions with polynomial and rational functions to form what the authors consider the **algebraic functions**,⁵ we can make sign diagrams using the procedure set forth in Section 4.2.

Steps for Constructing a Sign Diagram for an Algebraic Function

Suppose f is an algebraic function.

1. Place any values excluded from the domain of f on the number line with an ‘?’ above them.
2. Find the zeros of f and place them on the number line with the number 0 above them.
3. Choose a test value in each of the intervals determined in steps 1 and 2.
4. Determine the sign of $f(x)$ for each test value in step 3, and write that sign above the corresponding interval.

Our next example reviews quite a bit of Intermediate Algebra and demonstrates some of the new features of these graphs.

Example 5.3.1. For the following functions, state their domains and create sign diagrams. Check your answer graphically using your calculator.

$$1. f(x) = 3x\sqrt[3]{2-x}$$

$$2. g(x) = \sqrt{2 - \sqrt[4]{x+3}}$$

$$3. h(x) = \sqrt[3]{\frac{8x}{x+1}}$$

$$4. k(x) = \frac{2x}{\sqrt{x^2-1}}$$

Solution.

1. As far as domain is concerned, $f(x)$ has no denominators and no even roots, which means its domain is $(-\infty, \infty)$. To create the sign diagram, we find the zeros of f .

³Did you like that pun?

⁴In most other cases, though, rational exponents are preferred.

⁵As mentioned in Section 2.2, $f(x) = \sqrt{x^2} = |x|$ so that absolute value is also considered an algebraic function.

$$\begin{aligned}
 f(x) &= 0 \\
 3x\sqrt[3]{2-x} &= 0 \\
 3x = 0 &\text{ or } \sqrt[3]{2-x} = 0 \\
 x = 0 &\text{ or } (\sqrt[3]{2-x})^3 = 0^3 \\
 x = 0 &\text{ or } 2-x = 0 \\
 x = 0 &\text{ or } x = 2
 \end{aligned}$$

The zeros 0 and 2 divide the real number line into three test intervals. The sign diagram and accompanying graph are below. Note that the intervals on which f is (+) correspond to where the graph of f is above the x -axis, and where the graph of f is below the x -axis we have that f is (-). The calculator suggests something mysterious happens near $x = 2$. Zooming in shows the graph becomes nearly vertical there. You'll have to wait until Calculus to fully understand this phenomenon.

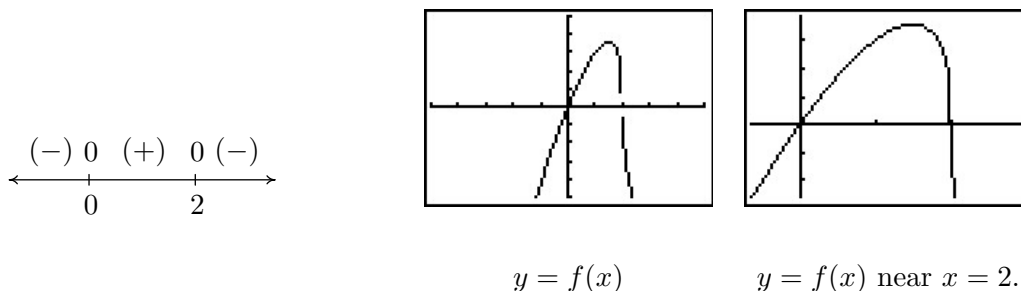

2. In $g(x) = \sqrt{2 - \sqrt[4]{x+3}}$, we have two radicals both of which are even indexed. To satisfy $\sqrt[4]{x+3}$, we require $x+3 \geq 0$ or $x \geq -3$. To satisfy $\sqrt{2 - \sqrt[4]{x+3}}$, we need $2 - \sqrt[4]{x+3} \geq 0$. While it may be tempting to write this as $2 \geq \sqrt[4]{x+3}$ and take both sides to the fourth power, there are times when this technique will produce erroneous results.⁶ Instead, we solve $2 - \sqrt[4]{x+3} \geq 0$ using a sign diagram. If we let $r(x) = 2 - \sqrt[4]{x+3}$, we know $x \geq -3$, so we concern ourselves with only this portion of the number line. To find the zeros of r we set $r(x) = 0$ and solve $2 - \sqrt[4]{x+3} = 0$. We get $\sqrt[4]{x+3} = 2$ so that $(\sqrt[4]{x+3})^4 = 2^4$ from which we obtain $x+3 = 16$ or $x = 13$. Since we raised both sides of an equation to an even power, we need to check to see if $x = 13$ is an extraneous solution.⁷ We find $x = 13$ does check since $2 - \sqrt[4]{x+3} = 2 - \sqrt[4]{13+3} = 2 - \sqrt[4]{16} = 2 - 2 = 0$. Below is our sign diagram for r .

$$\begin{array}{c}
 (+) \quad 0 \quad (-) \\
 \hline
 -3 \qquad 13
 \end{array}$$

We find $2 - \sqrt[4]{x+3} \geq 0$ on $[-3, 13]$ so this is the domain of g . To find a sign diagram for g , we look for the zeros of g . Setting $g(x) = 0$ is equivalent to $\sqrt{2 - \sqrt[4]{x+3}} = 0$. After squaring

⁶For instance, $-2 \geq \sqrt[4]{x+3}$, which has no solution or $-2 \leq \sqrt[4]{x+3}$ whose solution is $[-3, \infty)$.

⁷Recall, this means we have produced a candidate which doesn't satisfy the original equation. Do you remember how raising both sides of an equation to an even power could cause this?

both sides, we get $2 - \sqrt[4]{x+3} = 0$, whose solution we have found to be $x = 13$. Since we squared both sides, we double check and find $g(13)$ is, in fact, 0. Our sign diagram and graph of g are below. Since the domain of g is $[-3, 13]$, what we have below is not just a *portion* of the graph of g , but the *complete* graph. It is always above or on the x -axis, which verifies our sign diagram.

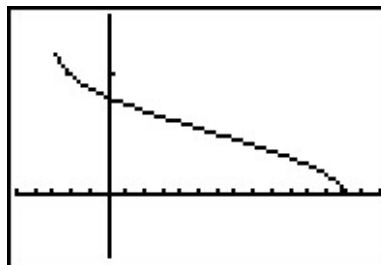
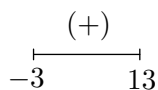

The complete graph of $y = g(x)$.

3. The radical in $h(x)$ is odd, so our only concern is the denominator. Setting $x + 1 = 0$ gives $x = -1$, so our domain is $(-\infty, -1) \cup (-1, \infty)$. To find the zeros of h , we set $h(x) = 0$. To solve $\sqrt[3]{\frac{8x}{x+1}} = 0$, we cube both sides to get $\frac{8x}{x+1} = 0$. We get $8x = 0$, or $x = 0$. Below is the resulting sign diagram and corresponding graph. From the graph, it appears as though $x = -1$ is a vertical asymptote. Carrying out an analysis as $x \rightarrow -1$ as in Section 4.2 confirms this. (We leave the details to the reader.) Near $x = 0$, we have a situation similar to $x = 2$ in the graph of f in number 1 above. Finally, it appears as if the graph of h has a horizontal asymptote $y = 2$. Using techniques from Section 4.2, we find as $x \rightarrow \pm\infty$, $\frac{8x}{x+1} \rightarrow 8$. From this, it is hardly surprising that as $x \rightarrow \pm\infty$, $h(x) = \sqrt[3]{\frac{8x}{x+1}} \approx \sqrt[3]{8} = 2$.

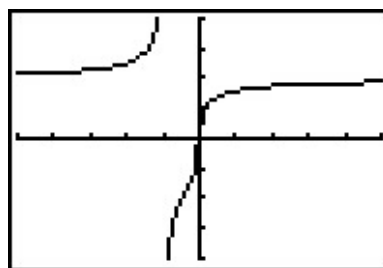
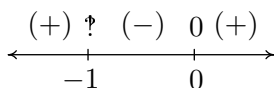

$y = h(x)$

4. To find the domain of k , we have both an even root and a denominator to concern ourselves with. To satisfy the square root, $x^2 - 1 \geq 0$. Setting $r(x) = x^2 - 1$, we find the zeros of r to be $x = \pm 1$, and we find the sign diagram of r to be

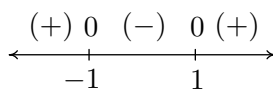

We find $x^2 - 1 \geq 0$ for $(-\infty, -1] \cup [1, \infty)$. To keep the denominator of $k(x)$ away from zero, we set $\sqrt{x^2 - 1} = 0$. We leave it to the reader to verify the solutions are $x = \pm 1$, both of which must be excluded from the domain. Hence, the domain of k is $(-\infty, -1) \cup (1, \infty)$. To build the sign diagram for k , we need the zeros of k . Setting $k(x) = 0$ results in $\frac{2x}{\sqrt{x^2 - 1}} = 0$. We get $2x = 0$ or $x = 0$. However, $x = 0$ isn't in the domain of k , which means k has no zeros. We construct our sign diagram on the domain of k below alongside the graph of k . It appears that the graph of k has two vertical asymptotes, one at $x = -1$ and one at $x = 1$. The gap in the graph between the asymptotes is because of the gap in the domain of k . Concerning end behavior, there appear to be two horizontal asymptotes, $y = 2$ and $y = -2$. To see why this is the case, we think of $x \rightarrow \pm\infty$. The radicand of the denominator $x^2 - 1 \approx x^2$, and as such, $k(x) = \frac{2x}{\sqrt{x^2 - 1}} \approx \frac{2x}{\sqrt{x^2}} = \frac{2x}{|x|}$. As $x \rightarrow \infty$, we have $|x| = x$ so $k(x) \approx \frac{2x}{x} = 2$. On the other hand, as $x \rightarrow -\infty$, $|x| = -x$, and as such $k(x) \approx \frac{2x}{-x} = -2$. Finally, it appears as though the graph of k passes the Horizontal Line Test which means k is one to one and k^{-1} exists. Computing k^{-1} is left as an exercise.

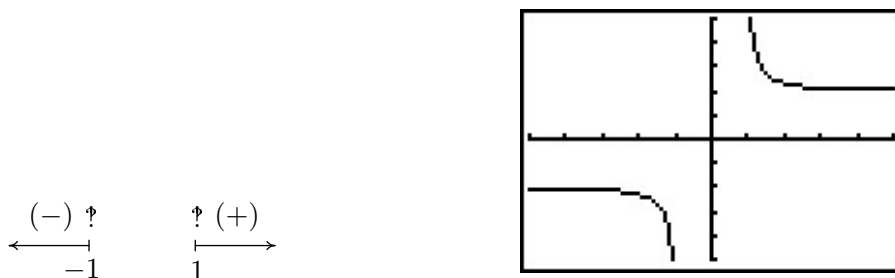

$$y = k(x)$$

□

As the previous example illustrates, the graphs of general algebraic functions can have features we've seen before, like vertical and horizontal asymptotes, but they can occur in new and exciting ways. For example, $k(x) = \frac{2x}{\sqrt{x^2 - 1}}$ had two distinct horizontal asymptotes. You'll recall that rational functions could have at most one horizontal asymptote. Also some new characteristics like 'unusual steepness'⁸ and cusps⁹ can appear in the graphs of arbitrary algebraic functions. Our next example first demonstrates how we can use sign diagrams to solve nonlinear inequalities. (Don't panic. The technique is very similar to the ones used in Chapters 2, 3 and 4.) We then check our answers graphically with a calculator and see some of the new graphical features of the functions in this extended family.

Example 5.3.2. Solve the following inequalities. Check your answers graphically with a calculator.

⁸The proper Calculus term for this is 'vertical tangent', but for now we'll be okay calling it 'unusual steepness'.

⁹See page 375 for the first reference to this feature.

1. $x^{2/3} < x^{4/3} - 6$

2. $3(2-x)^{1/3} \leq x(2-x)^{-2/3}$

Solution.

1. To solve $x^{2/3} < x^{4/3} - 6$, we get 0 on one side and attempt to solve $x^{4/3} - x^{2/3} - 6 > 0$. We set $r(x) = x^{4/3} - x^{2/3} - 6$ and note that since the denominators in the exponents are 3, they correspond to cube roots, which means the domain of r is $(-\infty, \infty)$. To find the zeros for the sign diagram, we set $r(x) = 0$ and attempt to solve $x^{4/3} - x^{2/3} - 6 = 0$. At this point, it may be unclear how to proceed. We could always try as a last resort converting back to radical notation, but in this case we can take a cue from Example 3.3.4. Since there are three terms, and the exponent on one of the variable terms, $x^{4/3}$, is exactly twice that of the other, $x^{2/3}$, we have ourselves a ‘quadratic in disguise’ and we can rewrite $x^{4/3} - x^{2/3} - 6 = 0$ as $(x^{2/3})^2 - x^{2/3} - 6 = 0$. If we let $u = x^{2/3}$, then in terms of u , we get $u^2 - u - 6 = 0$. Solving for u , we obtain $u = -2$ or $u = 3$. Replacing $x^{2/3}$ back in for u , we get $x^{2/3} = -2$ or $x^{2/3} = 3$. To avoid the trouble we encountered in the discussion following Definition 5.5, we now convert back to radical notation. By interpreting $x^{2/3}$ as $\sqrt[3]{x^2}$ we have $\sqrt[3]{x^2} = -2$ or $\sqrt[3]{x^2} = 3$. Cubing both sides of these equations results in $x^2 = -8$, which admits no real solution, or $x^2 = 27$, which gives $x = \pm 3\sqrt{3}$. We construct a sign diagram and find $x^{4/3} - x^{2/3} - 6 > 0$ on $(-\infty, -3\sqrt{3}) \cup (3\sqrt{3}, \infty)$. To check our answer graphically, we set $f(x) = x^{2/3}$ and $g(x) = x^{4/3} - 6$. The solution to $x^{2/3} < x^{4/3} - 6$ corresponds to the inequality $f(x) < g(x)$, which means we are looking for the x values for which the graph of f is below the graph of g . Using the ‘Intersect’ command we confirm¹⁰ that the graphs cross at $x = \pm 3\sqrt{3}$. We see that the graph of f is below the graph of g (the thicker curve) on $(-\infty, -3\sqrt{3}) \cup (3\sqrt{3}, \infty)$.

$$\begin{array}{ccccccc} (+) & 0 & (-) & 0 & (+) \\ \leftarrow & | & | & | & | & \rightarrow \\ & -3\sqrt{3} & & 3\sqrt{3} & & \end{array}$$

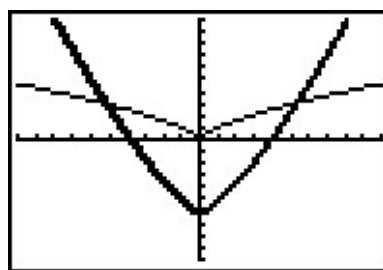

$$y = f(x) \text{ and } y = g(x)$$

As a point of interest, if we take a closer look at the graphs of f and g near $x = 0$ with the axes off, we see that despite the fact they both involve cube roots, they exhibit different behavior near $x = 0$. The graph of f has a sharp turn, or cusp, while g does not.¹¹

¹⁰Or at least confirm to several decimal places

¹¹Again, we introduced this feature on page 375 as a feature which makes the graph of a function ‘not smooth’.

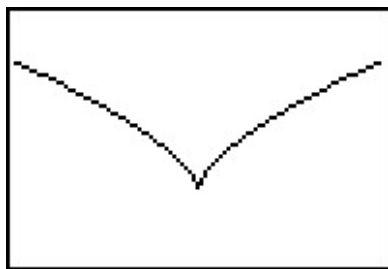
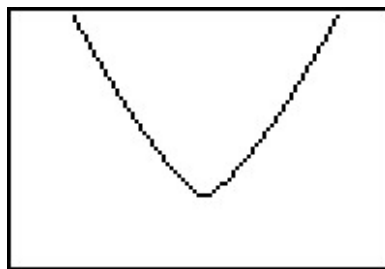
 $y = f(x)$ near $x = 0$  $y = g(x)$ near $x = 0$

2. To solve $3(2-x)^{1/3} \leq x(2-x)^{-2/3}$, we gather all the nonzero terms on one side and obtain $3(2-x)^{1/3} - x(2-x)^{-2/3} \leq 0$. We set $r(x) = 3(2-x)^{1/3} - x(2-x)^{-2/3}$. As in number 1, the denominators of the rational exponents are odd, which means there are no domain concerns there. However, the negative exponent on the second term indicates a denominator. Rewriting $r(x)$ with positive exponents, we obtain

$$r(x) = 3(2-x)^{1/3} - \frac{x}{(2-x)^{2/3}}$$

Setting the denominator equal to zero we get $(2-x)^{2/3} = 0$, or $\sqrt[3]{(2-x)^2} = 0$. After cubing both sides, and subsequently taking square roots, we get $2-x = 0$, or $x = 2$. Hence, the domain of r is $(-\infty, 2) \cup (2, \infty)$. To find the zeros of r , we set $r(x) = 0$. There are two school of thought on how to proceed and we demonstrate both.

- *Factoring Approach.* From $r(x) = 3(2-x)^{1/3} - x(2-x)^{-2/3}$, we note that the quantity $(2-x)$ is common to both terms. When we factor out common factors, we factor out the quantity with the *smaller* exponent. In this case, since $-\frac{2}{3} < \frac{1}{3}$, we factor $(2-x)^{-2/3}$ from both quantities. While it may seem odd to do so, we need to factor $(2-x)^{-2/3}$ from $(2-x)^{1/3}$, which results in subtracting the exponent $-\frac{2}{3}$ from $\frac{1}{3}$. We proceed using the usual properties of exponents.¹²

$$\begin{aligned} r(x) &= 3(2-x)^{1/3} - x(2-x)^{-2/3} \\ &= (2-x)^{-2/3} \left[3(2-x)^{\frac{1}{3}-(-\frac{2}{3})} - x \right] \\ &= (2-x)^{-2/3} [3(2-x)^{3/3} - x] \\ &= (2-x)^{-2/3} [3(2-x)^1 - x] && \text{since } \sqrt[3]{u^3} = (\sqrt[3]{u})^3 = u \\ &= (2-x)^{-2/3} (6-4x) \\ &= (2-x)^{-2/3} (6-4x) \end{aligned}$$

To solve $r(x) = 0$, we set $(2-x)^{-2/3} (6-4x) = 0$, or $\frac{6-4x}{(2-x)^{2/3}} = 0$. We have $6-4x = 0$ or $x = \frac{3}{2}$.

¹²And we exercise special care when reducing the $\frac{3}{3}$ power to 1.

- *Common Denominator Approach.* We rewrite

$$\begin{aligned}
 r(x) &= 3(2-x)^{1/3} - x(2-x)^{-2/3} \\
 &= 3(2-x)^{1/3} - \frac{x}{(2-x)^{2/3}} \\
 &= \frac{3(2-x)^{1/3}(2-x)^{2/3}}{(2-x)^{2/3}} - \frac{x}{(2-x)^{2/3}} && \text{common denominator} \\
 &= \frac{3(2-x)^{\frac{1}{3}+\frac{2}{3}}}{(2-x)^{2/3}} - \frac{x}{(2-x)^{2/3}} \\
 &= \frac{3(2-x)^{3/3}}{(2-x)^{2/3}} - \frac{x}{(2-x)^{2/3}} \\
 &= \frac{3(2-x)^1}{(2-x)^{2/3}} - \frac{x}{(2-x)^{2/3}} && \text{since } \sqrt[3]{u^3} = (\sqrt[3]{u})^3 = u \\
 &= \frac{3(2-x) - x}{(2-x)^{2/3}} \\
 &= \frac{6-4x}{(2-x)^{2/3}}
 \end{aligned}$$

As before, when we set $r(x) = 0$ we obtain $x = \frac{3}{2}$.

We now create our sign diagram and find $3(2-x)^{1/3} - x(2-x)^{-2/3} \leq 0$ on $[\frac{3}{2}, 2) \cup (2, \infty)$. To check this graphically, we set $f(x) = 3(2-x)^{1/3}$ and $g(x) = x(2-x)^{-2/3}$ (the thicker curve). We confirm that the graphs intersect at $x = \frac{3}{2}$ and the graph of f is below the graph of g for $x \geq \frac{3}{2}$, with the exception of $x = 2$ where it appears the graph of g has a vertical asymptote.

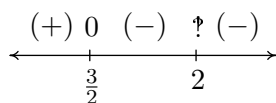

$$y = f(x) \text{ and } y = g(x) \quad \square$$

One application of algebraic functions was given in Example 1.6.6 in Section 1.1. Our last example is a more sophisticated application of distance.

Example 5.3.3. Carl wishes to get high speed internet service installed in his remote Sasquatch observation post located 30 miles from Route 117. The nearest junction box is located 50 miles downroad from the post, as indicated in the diagram below. Suppose it costs \$15 per mile to run cable along the road and \$20 per mile to run cable off of the road.

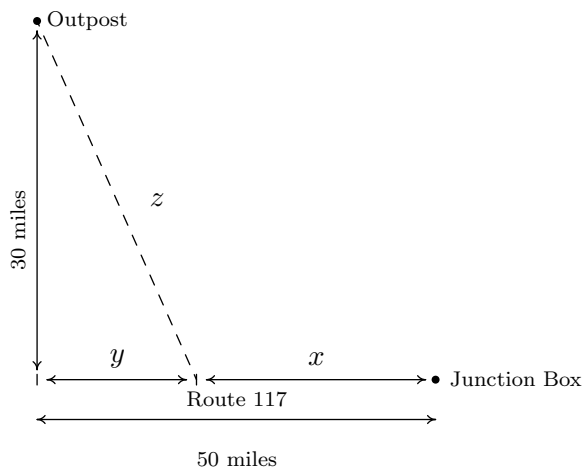

1. Express the total cost C of connecting the Junction Box to the Outpost as a function of x , the number of miles the cable is run along Route 117 before heading off road directly towards the Outpost. Determine a reasonable applied domain for the problem.
2. Use your calculator to graph $y = C(x)$ on its domain. What is the minimum cost? How far along Route 117 should the cable be run before turning off of the road?

Solution.

1. The cost is broken into two parts: the cost to run cable along Route 117 at \$15 per mile, and the cost to run it off road at \$20 per mile. Since x represents the miles of cable run along Route 117, the cost for that portion is $15x$. From the diagram, we see that the number of miles the cable is run off road is z , so the cost of that portion is $20z$. Hence, the total cost is $C = 15x + 20z$. Our next goal is to determine z as a function of x . The diagram suggests we can use the Pythagorean Theorem to get $y^2 + 30^2 = z^2$. But we also see $x + y = 50$ so that $y = 50 - x$. Hence, $z^2 = (50 - x)^2 + 900$. Solving for z , we obtain $z = \pm\sqrt{(50 - x)^2 + 900}$. Since z represents a distance, we choose $z = \sqrt{(50 - x)^2 + 900}$ so that our cost as a function of x only is given by

$$C(x) = 15x + 20\sqrt{(50 - x)^2 + 900}$$

From the context of the problem, we have $0 \leq x \leq 50$.

2. Graphing $y = C(x)$ on a calculator and using the 'Minimum' feature, we find the relative minimum (which is also the absolute minimum in this case) to two decimal places to be (15.98, 1146.86). Here the x -coordinate tells us that in order to minimize cost, we should run 15.98 miles of cable along Route 117 and then turn off of the road and head towards the outpost. The y -coordinate tells us that the minimum cost, in dollars, to do so is \$1146.86. The ability to stream live SasquatchCasts? Priceless. \square

5.3.1 EXERCISES

For each function in Exercises 1 - 10 below

- Find its domain.
- Create a sign diagram.
- Use your calculator to help you sketch its graph and identify any vertical or horizontal asymptotes, ‘unusual steepness’ or cusps.

1. $f(x) = \sqrt{1 - x^2}$

2. $f(x) = \sqrt{x^2 - 1}$

3. $f(x) = x\sqrt{1 - x^2}$

4. $f(x) = x\sqrt{x^2 - 1}$

5. $f(x) = \sqrt[4]{\frac{16x}{x^2 - 9}}$

6. $f(x) = \frac{5x}{\sqrt[3]{x^3 + 8}}$

7. $f(x) = x^{\frac{2}{3}}(x - 7)^{\frac{1}{3}}$

8. $f(x) = x^{\frac{3}{2}}(x - 7)^{\frac{1}{3}}$

9. $f(x) = \sqrt{x(x + 5)(x - 4)}$

10. $f(x) = \sqrt[3]{x^3 + 3x^2 - 6x - 8}$

In Exercises 11 - 16, sketch the graph of $y = g(x)$ by starting with the graph of $y = f(x)$ and using the transformations presented in Section 1.7.

11. $f(x) = \sqrt[3]{x}, g(x) = \sqrt[3]{x - 1} - 2$

12. $f(x) = \sqrt[3]{x}, g(x) = -2\sqrt[3]{x + 1} + 4$

13. $f(x) = \sqrt[4]{x}, g(x) = \sqrt[4]{x - 1} - 2$

14. $f(x) = \sqrt[4]{x}, g(x) = 3\sqrt[4]{x - 7} - 1$

15. $f(x) = \sqrt[5]{x}, g(x) = \sqrt[5]{x + 2} + 3$

16. $f(x) = \sqrt[8]{x}, g(x) = \sqrt[8]{-x} - 2$

In Exercises 17 - 35, solve the equation or inequality.

17. $x + 1 = \sqrt{3x + 7}$

18. $2x + 1 = \sqrt{3 - 3x}$

19. $x + \sqrt{3x + 10} = -2$

20. $3x + \sqrt{6 - 9x} = 2$

21. $2x - 1 = \sqrt{x + 3}$

22. $x^{\frac{3}{2}} = 8$

23. $x^{\frac{2}{3}} = 4$

24. $\sqrt{x - 2} + \sqrt{x - 5} = 3$

25. $\sqrt{2x + 1} = 3 + \sqrt{4 - x}$

26. $5 - (4 - 2x)^{\frac{2}{3}} = 1$

27. $10 - \sqrt{x - 2} \leq 11$

28. $\sqrt[3]{x} \leq x$

29. $2(x-2)^{-\frac{1}{3}} - \frac{2}{3}x(x-2)^{-\frac{4}{3}} \leq 0$
30. $-\frac{4}{3}(x-2)^{-\frac{4}{3}} + \frac{8}{9}x(x-2)^{-\frac{7}{3}} \geq 0$
31. $2x^{-\frac{1}{3}}(x-3)^{\frac{1}{3}} + x^{\frac{2}{3}}(x-3)^{-\frac{2}{3}} \geq 0$
32. $\sqrt[3]{x^3 + 3x^2 - 6x - 8} > x + 1$
33. $\frac{1}{3}x^{\frac{3}{4}}(x-3)^{-\frac{2}{3}} + \frac{3}{4}x^{-\frac{1}{4}}(x-3)^{\frac{1}{3}} < 0$
34. $x^{-\frac{1}{3}}(x-3)^{-\frac{2}{3}} - x^{-\frac{4}{3}}(x-3)^{-\frac{5}{3}}(x^2 - 3x + 2) \geq 0$
35. $\frac{2}{3}(x+4)^{\frac{3}{5}}(x-2)^{-\frac{1}{3}} + \frac{3}{5}(x+4)^{-\frac{2}{5}}(x-2)^{\frac{2}{3}} \geq 0$
36. Rework Example 5.3.3 so that the outpost is 10 miles from Route 117 and the nearest junction box is 30 miles down the road for the post.
37. The volume V of a right cylindrical cone depends on the radius of its base r and its height h and is given by the formula $V = \frac{1}{3}\pi r^2 h$. The surface area S of a right cylindrical cone also depends on r and h according to the formula $S = \pi r\sqrt{r^2 + h^2}$. Suppose a cone is to have a volume of 100 cubic centimeters.
- Use the formula for volume to find the height h as a function of r .
 - Use the formula for surface area and your answer to 37a to find the surface area S as a function of r .
 - Use your calculator to find the values of r and h which minimize the surface area. What is the minimum surface area? Round your answers to two decimal places.
38. The [National Weather Service](#) uses the following formula to calculate the wind chill:

$$W = 35.74 + 0.6215 T_a - 35.75 V^{0.16} + 0.4275 T_a V^{0.16}$$

where W is the wind chill temperature in °F, T_a is the air temperature in °F, and V is the wind speed in miles per hour. Note that W is defined only for air temperatures at or lower than 50°F and wind speeds above 3 miles per hour.

- Suppose the air temperature is 42° and the wind speed is 7 miles per hour. Find the wind chill temperature. Round your answer to two decimal places.
 - Suppose the air temperature is 37°F and the wind chill temperature is 30°F. Find the wind speed. Round your answer to two decimal places.
39. As a follow-up to Exercise 38, suppose the air temperature is 28°F.
- Use the formula from Exercise 38 to find an expression for the wind chill temperature as a function of the wind speed, $W(V)$.
 - Solve $W(V) = 0$, round your answer to two decimal places, and interpret.
 - Graph the function W using your calculator and check your answer to part 39b.

40. The period of a pendulum in seconds is given by

$$T = 2\pi\sqrt{\frac{L}{g}}$$

(for small displacements) where L is the length of the pendulum in meters and $g = 9.8$ meters per second per second is the acceleration due to gravity. My Seth-Thomas antique schoolhouse clock needs $T = \frac{1}{2}$ second and I can adjust the length of the pendulum via a small dial on the bottom of the bob. At what length should I set the pendulum?

41. The Cobb-Douglas production model states that the yearly total dollar value of the production output P in an economy is a function of labor x (the total number of hours worked in a year) and capital y (the total dollar value of all of the stuff purchased in order to make things). Specifically, $P = ax^by^{1-b}$. By fixing P , we create what's known as an 'isoquant' and we can then solve for y as a function of x . Let's assume that the Cobb-Douglas production model for the country of Sasquatchia is $P = 1.23x^{0.4}y^{0.6}$.

- (a) Let $P = 300$ and solve for y in terms of x . If $x = 100$, what is y ?
- (b) Graph the isoquant $300 = 1.23x^{0.4}y^{0.6}$. What information does an ordered pair (x, y) which makes $P = 300$ give you? With the help of your classmates, find several different combinations of labor and capital all of which yield $P = 300$. Discuss any patterns you may see.

42. According to Einstein's Theory of Special Relativity, the observed mass m of an object is a function of how fast the object is traveling. Specifically,

$$m(x) = \frac{m_r}{\sqrt{1 - \frac{x^2}{c^2}}}$$

where $m(0) = m_r$ is the mass of the object at rest, x is the speed of the object and c is the speed of light.

- (a) Find the applied domain of the function.
- (b) Compute $m(.1c)$, $m(.5c)$, $m(.9c)$ and $m(.999c)$.
- (c) As $x \rightarrow c^-$, what happens to $m(x)$?
- (d) How slowly must the object be traveling so that the observed mass is no greater than 100 times its mass at rest?
43. Find the inverse of $k(x) = \frac{2x}{\sqrt{x^2 - 1}}$.

44. Suppose Fritzy the Fox, positioned at a point (x, y) in the first quadrant, spots Chewbacca the Bunny at $(0, 0)$. Chewbacca begins to run along a fence (the positive y -axis) towards his warren. Fritzy, of course, takes chase and constantly adjusts his direction so that he is always running directly at Chewbacca. If Chewbacca's speed is v_1 and Fritzy's speed is v_2 , the path Fritzy will take to intercept Chewbacca, provided v_2 is directly proportional to, but not equal to, v_1 is modeled by

$$y = \frac{1}{2} \left(\frac{x^{1+v_1/v_2}}{1+v_1/v_2} - \frac{x^{1-v_1/v_2}}{1-v_1/v_2} \right) + \frac{v_1 v_2}{v_2^2 - v_1^2}$$

- (a) Determine the path that Fritzy will take if he runs exactly twice as fast as Chewbacca; that is, $v_2 = 2v_1$. Use your calculator to graph this path for $x \geq 0$. What is the significance of the y -intercept of the graph?
- (b) Determine the path Fritzy will take if Chewbacca runs exactly twice as fast as he does; that is, $v_1 = 2v_2$. Use your calculator to graph this path for $x > 0$. Describe the behavior of y as $x \rightarrow 0^+$ and interpret this physically.
- (c) With the help of your classmates, generalize parts (a) and (b) to two cases: $v_2 > v_1$ and $v_2 < v_1$. We will discuss the case of $v_1 = v_2$ in Exercise 32 in Section 6.5.
45. Verify the Quotient Rule for Radicals in Theorem 5.6.
46. Show that $\left(x^{\frac{3}{2}}\right)^{\frac{2}{3}} = x$ for all $x \geq 0$.
47. Show that $\sqrt[3]{2}$ is an irrational number by first showing that it is a zero of $p(x) = x^3 - 2$ and then showing p has no rational zeros. (You'll need the Rational Zeros Theorem, Theorem 3.9, in order to show this last part.)
48. With the help of your classmates, generalize Exercise 47 to show that $\sqrt[n]{c}$ is an irrational number for any natural numbers $c \geq 2$ and $n \geq 2$ provided that $c \neq p^n$ for some natural number p .

5.3.2 ANSWERS

1. $f(x) = \sqrt{1 - x^2}$

Domain: $[-1, 1]$

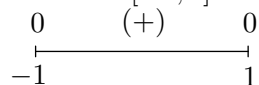

No asymptotes

Unusual steepness at $x = -1$ and $x = 1$

No cusps

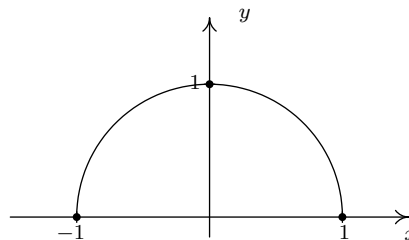

2. $f(x) = \sqrt{x^2 - 1}$

Domain: $(-\infty, -1] \cup [1, \infty)$

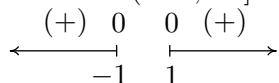

No asymptotes

Unusual steepness at $x = -1$ and $x = 1$

No cusps

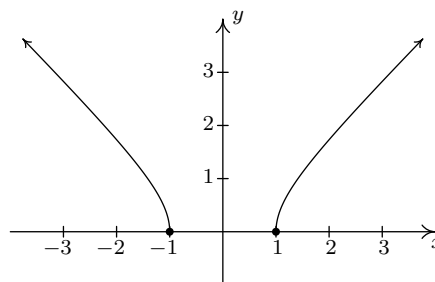

3. $f(x) = x\sqrt{1 - x^2}$

Domain: $[-1, 1]$

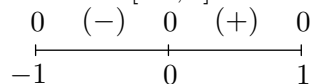

No asymptotes

Unusual steepness at $x = -1$ and $x = 1$

No cusps

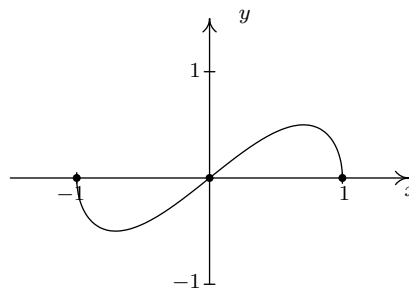

4. $f(x) = x\sqrt{x^2 - 1}$

Domain: $(-\infty, -1] \cup [1, \infty)$

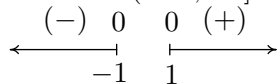

No asymptotes

Unusual steepness at $x = -1$ and $x = 1$

No cusps

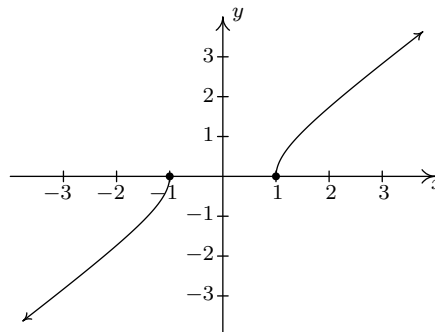

$$5. f(x) = \sqrt[4]{\frac{16x}{x^2 - 9}}$$

Domain: $(-3, 0] \cup (3, \infty)$

‡ (+) 0 ‡ (+)

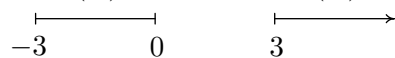

Vertical asymptotes: $x = -3$ and $x = 3$

Horizontal asymptote: $y = 0$

Unusual steepness at $x = 0$

No cusps

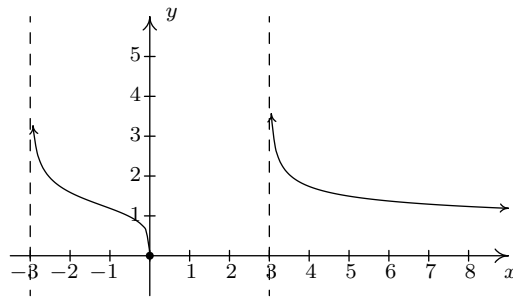

$$6. f(x) = \frac{5x}{\sqrt[3]{x^3 + 8}}$$

Domain: $(-\infty, -2) \cup (-2, \infty)$

(+) ‡ (-) 0 (+)

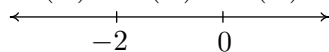

Vertical asymptote $x = -2$

Horizontal asymptote $y = 5$

No unusual steepness or cusps

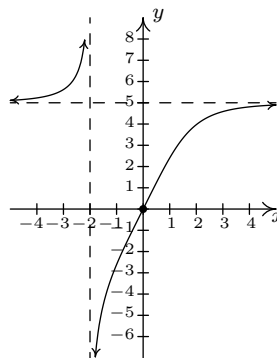

$$7. f(x) = x^{\frac{2}{3}}(x - 7)^{\frac{1}{3}}$$

Domain: $(-\infty, \infty)$

(-) 0 (-) 0 (+)

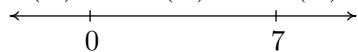

No vertical or horizontal asymptotes¹³

Unusual steepness at $x = 7$

Cusp at $x = 0$

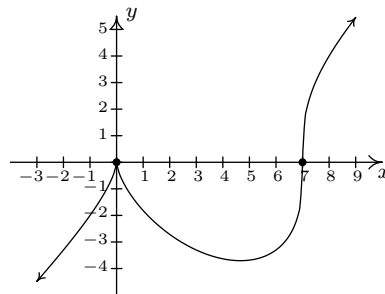

$$8. f(x) = x^{\frac{3}{2}}(x - 7)^{\frac{1}{3}}$$

Domain: $[0, \infty)$

0 (-) 0 (+)

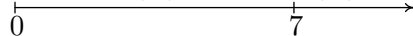

No asymptotes

Unusual steepness at $x = 7$

No cusps

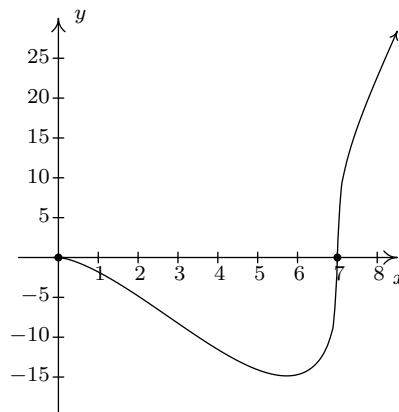

¹³Using Calculus it can be shown that $y = x - \frac{7}{3}$ is a slant asymptote of this graph.

9. $f(x) = \sqrt{x(x+5)(x-4)}$

Domain: $[-5, 0] \cup [4, \infty)$

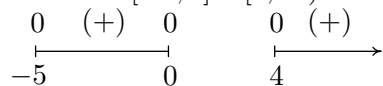

No asymptotes

Unusual steepness at $x = -5, x = 0$ and $x = 4$

No cusps

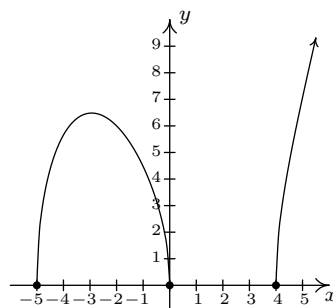

10. $f(x) = \sqrt[3]{x^3 + 3x^2 - 6x - 8}$

Domain: $(-\infty, \infty)$

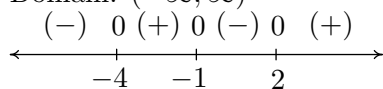

No vertical or horizontal asymptotes¹⁴

Unusual steepness at $x = -4, x = -1$ and $x = 2$

No cusps

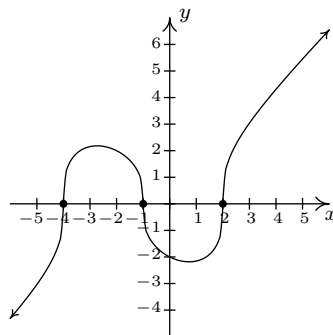

11. $g(x) = \sqrt[3]{x-1} - 2$

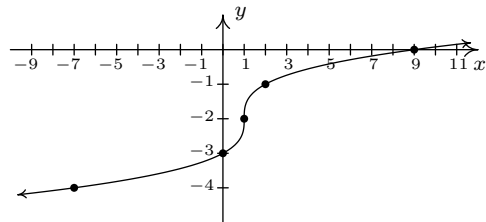

12. $g(x) = -2\sqrt[3]{x+1} + 4$

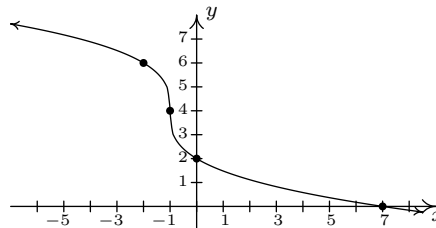

13. $g(x) = \sqrt[4]{x-1} - 2$

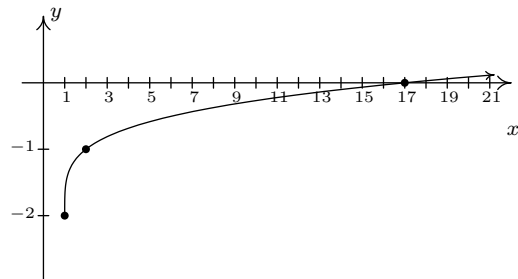

14. $g(x) = 3\sqrt[4]{x-7} - 1$

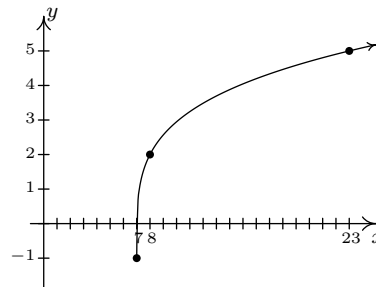

¹⁴Using Calculus it can be shown that $y = x + 1$ is a slant asymptote of this graph.

15. $g(x) = \sqrt[5]{x+2} + 3$

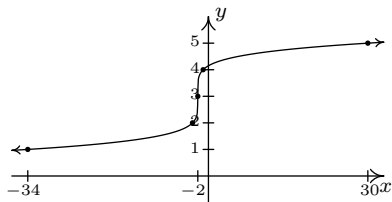

16. $g(x) = \sqrt[8]{-x} - 2$

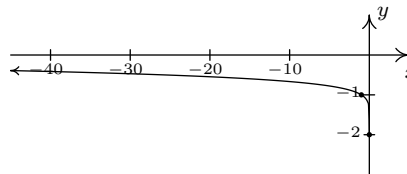

17. $x = 3$

18. $x = \frac{1}{4}$

19. $x = -3$

20. $x = -\frac{1}{3}, \frac{2}{3}$

21. $x = \frac{5+\sqrt{57}}{8}$

22. $x = 4$

23. $x = \pm 8$

24. $x = 6$

25. $x = 4$

26. $x = -2, 6$

27. $[2, \infty)$

28. $[-1, 0] \cup [1, \infty)$

29. $(-\infty, 2) \cup (2, 3]$

30. $(2, 6]$

31. $(-\infty, 0) \cup [2, 3) \cup (3, \infty)$

32. $(-\infty, -1)$

33. $(0, \frac{27}{13})$

34. $(-\infty, 0) \cup (0, 3)$

35. $(-\infty, -4) \cup (-4, -\frac{22}{19}] \cup (2, \infty)$

36. $C(x) = 15x + 20\sqrt{100 + (30 - x)^2}$, $0 \leq x \leq 30$. The calculator gives the absolute minimum at $\approx (18.66, 582.29)$. This means to minimize the cost, approximately 18.66 miles of cable should be run along Route 117 before turning off the road and heading towards the outpost. The minimum cost to run the cable is approximately \$582.29.

37. (a) $h(r) = \frac{300}{\pi r^2}$, $r > 0$.

(b) $S(r) = \pi r \sqrt{r^2 + \left(\frac{300}{\pi r^2}\right)^2} = \frac{\sqrt{\pi^2 r^6 + 90000}}{r}$, $r > 0$

(c) The calculator gives the absolute minimum at the point $\approx (4.07, 90.23)$. This means the radius should be (approximately) 4.07 centimeters and the height should be 5.76 centimeters to give a minimum surface area of 90.23 square centimeters.

38. (a) $W \approx 37.55^\circ\text{F}$.

(b) $V \approx 9.84$ miles per hour.

39. (a) $W(V) = 53.142 - 23.78V^{0.16}$. Since we are told in Exercise 38 that wind chill is only effect for wind speeds of more than 3 miles per hour, we restrict the domain to $V > 3$.

(b) $W(V) = 0$ when $V \approx 152.29$. This means, according to the model, for the wind chill temperature to be 0°F , the wind speed needs to be 152.29 miles per hour.

(c) The graph is below.

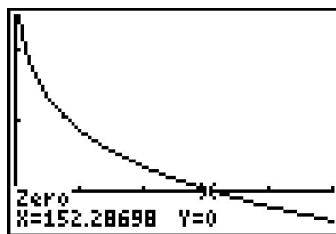

40. $9.8 \left(\frac{1}{4\pi} \right)^2 \approx 0.062$ meters or 6.2 centimeters

41. (a) First rewrite the model as $P = 1.23x^{\frac{2}{5}}y^{\frac{3}{5}}$. Then $300 = 1.23x^{\frac{2}{5}}y^{\frac{3}{5}}$ yields $y = \left(\frac{300}{1.23x^{\frac{2}{5}}} \right)^{\frac{5}{3}}$.
If $x = 100$ then $y \approx 441.93687$.

42. (a) $[0, c)$

(b)

$$m(.1c) = \frac{m_r}{\sqrt{.99}} \approx 1.005m_r \quad m(.5c) = \frac{m_r}{\sqrt{.75}} \approx 1.155m_r$$

$$m(.9c) = \frac{m_r}{\sqrt{.19}} \approx 2.294m_r \quad m(.999c) = \frac{m_r}{\sqrt{.001999}} \approx 22.366m_r$$

(c) As $x \rightarrow c^-$, $m(x) \rightarrow \infty$

(d) If the object is traveling no faster than approximately 0.99995 times the speed of light, then its observed mass will be no greater than $100m_r$.

43. $k^{-1}(x) = \frac{x}{\sqrt{x^2 - 4}}$

44. (a) $y = \frac{1}{3}x^{3/2} - \sqrt{x} + \frac{2}{3}$. The point $(0, \frac{2}{3})$ is when Fritzy's path crosses Chewbacca's path - in other words, where Fritzy catches Chewbacca.

(b) $y = \frac{1}{6}x^3 + \frac{1}{2x} - \frac{2}{3}$. Using the techniques from Chapter 4, we find as $x \rightarrow 0^+$, $y \rightarrow \infty$ which means, in this case, Fritzy's pursuit never ends; he never catches Chewbacca. This makes sense since Chewbacca has a head start and is running faster than Fritzy.

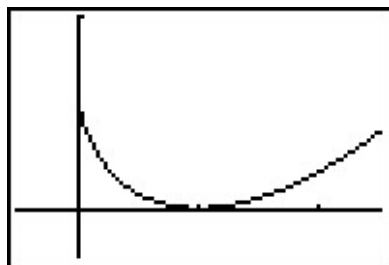

$$y = \frac{1}{3}x^{3/2} - \sqrt{x} + \frac{2}{3}$$

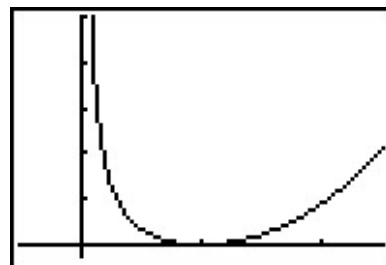

$$y = \frac{1}{6}x^3 + \frac{1}{2x} - \frac{2}{3}$$

CHAPTER 6

EXPONENTIAL AND LOGARITHMIC FUNCTIONS

6.1 INTRODUCTION TO EXPONENTIAL AND LOGARITHMIC FUNCTIONS

Of all of the functions we study in this text, exponential and logarithmic functions are possibly the ones which impact everyday life the most.¹ This section introduces us to these functions while the rest of the chapter will more thoroughly explore their properties. Up to this point, we have dealt with functions which involve terms like x^2 or $x^{2/3}$, in other words, terms of the form x^p where the base of the term, x , varies but the exponent of each term, p , remains constant. In this chapter, we study functions of the form $f(x) = b^x$ where the base b is a constant and the exponent x is the variable. We start our exploration of these functions with $f(x) = 2^x$. (Apparently this is a tradition. Every College Algebra book we have ever read starts with $f(x) = 2^x$.) We make a table of values, plot the points and connect the dots in a pleasing fashion.

x	$f(x)$	$(x, f(x))$
-3	$2^{-3} = \frac{1}{8}$	$(-3, \frac{1}{8})$
-2	$2^{-2} = \frac{1}{4}$	$(-2, \frac{1}{4})$
-1	$2^{-1} = \frac{1}{2}$	$(-1, \frac{1}{2})$
0	$2^0 = 1$	$(0, 1)$
1	$2^1 = 2$	$(1, 2)$
2	$2^2 = 4$	$(2, 4)$
3	$2^3 = 8$	$(3, 8)$

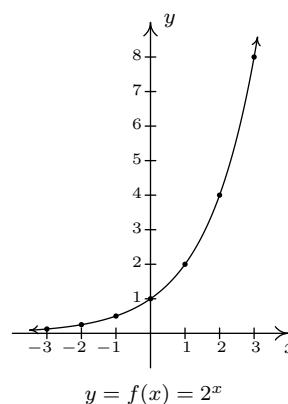

A few remarks about the graph of $f(x) = 2^x$ which we have constructed are in order. As $x \rightarrow -\infty$

¹Take a class in Differential Equations and you'll see why.

and attains values like $x = -100$ or $x = -1000$, the function $f(x) = 2^x$ takes on values like $f(-100) = 2^{-100} = \frac{1}{2^{100}}$ or $f(-1000) = 2^{-1000} = \frac{1}{2^{1000}}$. In other words, as $x \rightarrow -\infty$,

$$2^x \approx \frac{1}{\text{very big (+)}} \approx \text{very small (+)}$$

So as $x \rightarrow -\infty$, $2^x \rightarrow 0^+$. This is represented graphically using the x -axis (the line $y = 0$) as a horizontal asymptote. On the flip side, as $x \rightarrow \infty$, we find $f(100) = 2^{100}$, $f(1000) = 2^{1000}$, and so on, thus $2^x \rightarrow \infty$. As a result, our graph suggests the range of f is $(0, \infty)$. The graph of f passes the Horizontal Line Test which means f is one-to-one and hence invertible. We also note that when we ‘connected the dots in a pleasing fashion’, we have made the implicit assumption that $f(x) = 2^x$ is continuous² and has a domain of all real numbers. In particular, we have suggested that things like $2^{\sqrt{3}}$ exist as real numbers. We should take a moment to discuss what something like $2^{\sqrt{3}}$ might mean, and refer the interested reader to a solid course in Calculus for a more rigorous explanation. The number $\sqrt{3} = 1.73205\dots$ is an irrational number³ and as such, its decimal representation neither repeats nor terminates. We can, however, approximate $\sqrt{3}$ by terminating decimals, and it stands to reason⁴ we can use these to approximate $2^{\sqrt{3}}$. For example, if we approximate $\sqrt{3}$ by 1.73, we can approximate $2^{\sqrt{3}} \approx 2^{1.73} = 2^{\frac{173}{100}} = \sqrt[100]{2^{173}}$. It is not, by any means, a pleasant number, but it is at least a number that we understand in terms of powers and roots. It also stands to reason that better and better approximations of $\sqrt{3}$ yield better and better approximations of $2^{\sqrt{3}}$, so the value of $2^{\sqrt{3}}$ should be the result of this sequence of approximations.⁵

Suppose we wish to study the family of functions $f(x) = b^x$. Which bases b make sense to study? We find that we run into difficulty if $b < 0$. For example, if $b = -2$, then the function $f(x) = (-2)^x$ has trouble, for instance, at $x = \frac{1}{2}$ since $(-2)^{1/2} = \sqrt{-2}$ is not a real number. In general, if x is any rational number with an even denominator, then $(-2)^x$ is not defined, so we must restrict our attention to bases $b \geq 0$. What about $b = 0$? The function $f(x) = 0^x$ is undefined for $x \leq 0$ because we cannot divide by 0 and 0^0 is an indeterminate form. For $x > 0$, $0^x = 0$ so the function $f(x) = 0^x$ is the same as the function $f(x) = 0$, $x > 0$. We know everything we can possibly know about this function, so we exclude it from our investigations. The only other base we exclude is $b = 1$, since the function $f(x) = 1^x = 1$ is, once again, a function we have already studied. We are now ready for our definition of exponential functions.

Definition 6.1. A function of the form $f(x) = b^x$ where b is a fixed real number, $b > 0$, $b \neq 1$ is called a **base b exponential function**.

We leave it to the reader to verify⁶ that if $b > 1$, then the exponential function $f(x) = b^x$ will share the same basic shape and characteristics as $f(x) = 2^x$. What if $0 < b < 1$? Consider $g(x) = (\frac{1}{2})^x$. We could certainly build a table of values and connect the points, or we could take a step back and

²Recall that this means there are no holes or other kinds of breaks in the graph.

³You can actually prove this by considering the polynomial $p(x) = x^2 - 3$ and showing it has no rational zeros by applying Theorem 3.9.

⁴This is where Calculus and continuity come into play.

⁵Want more information? Look up ‘convergent sequences’ on the Internet.

⁶Meaning, graph some more examples on your own.

note that $g(x) = \left(\frac{1}{2}\right)^x = (2^{-1})^x = 2^{-x} = f(-x)$, where $f(x) = 2^x$. Thinking back to Section 1.7, the graph of $f(-x)$ is obtained from the graph of $f(x)$ by reflecting it across the y -axis. We get

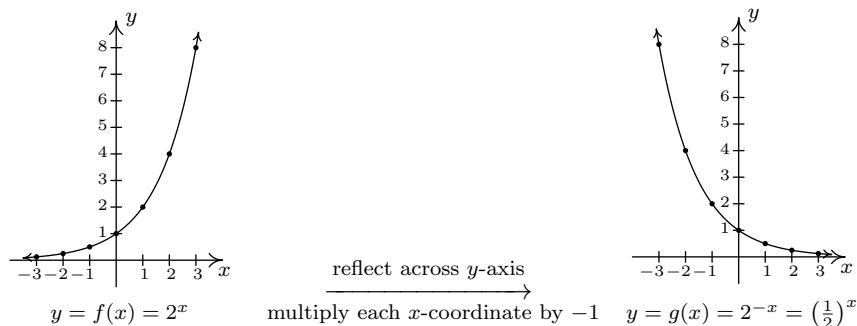

We see that the domain and range of g match that of f , namely $(-\infty, \infty)$ and $(0, \infty)$, respectively. Like f , g is also one-to-one. Whereas f is always increasing, g is always decreasing. As a result, as $x \rightarrow -\infty$, $g(x) \rightarrow \infty$, and on the flip side, as $x \rightarrow \infty$, $g(x) \rightarrow 0^+$. It shouldn't be too surprising that for all choices of the base $0 < b < 1$, the graph of $y = b^x$ behaves similarly to the graph of g . We summarize the basic properties of exponential functions in the following theorem.⁷

Theorem 6.1. Properties of Exponential Functions: Suppose $f(x) = b^x$.

- The domain of f is $(-\infty, \infty)$ and the range of f is $(0, \infty)$.
 - $(0, 1)$ is on the graph of f and $y = 0$ is a horizontal asymptote to the graph of f .
 - f is one-to-one, continuous and smooth^a
- | | |
|--|---|
| <ul style="list-style-type: none"> • If $b > 1$: <ul style="list-style-type: none"> – f is always increasing – As $x \rightarrow -\infty$, $f(x) \rightarrow 0^+$ – As $x \rightarrow \infty$, $f(x) \rightarrow \infty$ – The graph of f resembles: | <ul style="list-style-type: none"> • If $0 < b < 1$: <ul style="list-style-type: none"> – f is always decreasing – As $x \rightarrow -\infty$, $f(x) \rightarrow \infty$ – As $x \rightarrow \infty$, $f(x) \rightarrow 0^+$ – The graph of f resembles: |
|--|---|

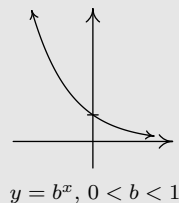
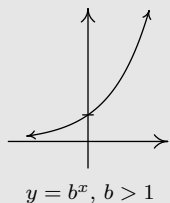

^aRecall that this means the graph of f has no sharp turns or corners.

⁷The proof of which, like many things discussed in the text, requires Calculus.

Of all of the bases for exponential functions, two occur the most often in scientific circles. The first, base 10, is often called the **common base**. The second base is an irrational number, $e \approx 2.718$, called the **natural base**. We will more formally discuss the origins of this number in Section 6.5. For now, it is enough to know that since $e > 1$, $f(x) = e^x$ is an increasing exponential function. The following examples give us an idea how these functions are used in the wild.

Example 6.1.1. The value of a car can be modeled by $V(x) = 25 \left(\frac{4}{5}\right)^x$, where $x \geq 0$ is age of the car in years and $V(x)$ is the value in thousands of dollars.

1. Find and interpret $V(0)$.
2. Sketch the graph of $y = V(x)$ using transformations.
3. Find and interpret the horizontal asymptote of the graph you found in 2.

Solution.

1. To find $V(0)$, we replace x with 0 to obtain $V(0) = 25 \left(\frac{4}{5}\right)^0 = 25$. Since x represents the age of the car in years, $x = 0$ corresponds to the car being brand new. Since $V(x)$ is measured in thousands of dollars, $V(0) = 25$ corresponds to a value of \$25,000. Putting it all together, we interpret $V(0) = 25$ to mean the purchase price of the car was \$25,000.
2. To graph $y = 25 \left(\frac{4}{5}\right)^x$, we start with the basic exponential function $f(x) = \left(\frac{4}{5}\right)^x$. Since the base $b = \frac{4}{5}$ is between 0 and 1, the graph of $y = f(x)$ is decreasing. We plot the y -intercept $(0, 1)$ and two other points, $(-1, \frac{5}{4})$ and $(1, \frac{4}{5})$, and label the horizontal asymptote $y = 0$. To obtain $V(x) = 25 \left(\frac{4}{5}\right)^x$, $x \geq 0$, we multiply the output from f by 25, in other words, $V(x) = 25f(x)$. In accordance with Theorem 1.5, this results in a vertical stretch by a factor of 25. We multiply all of the y values in the graph by 25 (including the y value of the horizontal asymptote) and obtain the points $(-1, \frac{125}{4})$, $(0, 25)$ and $(1, 20)$. The horizontal asymptote remains $y = 0$. Finally, we restrict the domain to $[0, \infty)$ to fit with the applied domain given to us. We have the result below.

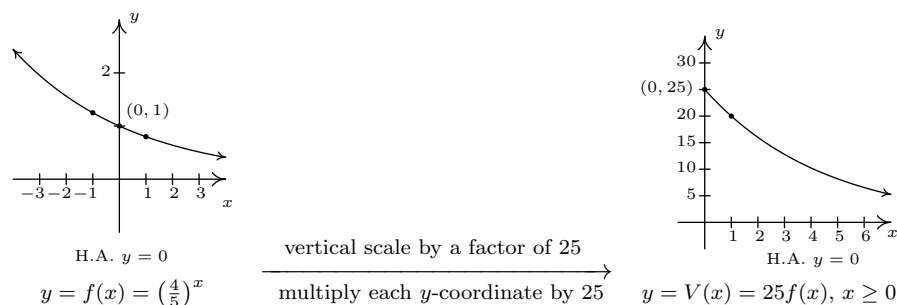

3. We see from the graph of V that its horizontal asymptote is $y = 0$. (We leave it to reader to verify this analytically by thinking about what happens as we take larger and larger powers of $\frac{4}{5}$.) This means as the car gets older, its value diminishes to 0. \square

The function in the previous example is often called a ‘decay curve’. Increasing exponential functions are used to model ‘growth curves’ and we shall see several different examples of those in Section 6.5. For now, we present another common decay curve which will serve as the basis for further study of exponential functions. Although it may look more complicated than the previous example, it is actually just a basic exponential function which has been modified by a few transformations from Section 1.7.

Example 6.1.2. According to [Newton’s Law of Cooling](#)⁸ the temperature of coffee T (in degrees Fahrenheit) t minutes after it is served can be modeled by $T(t) = 70 + 90e^{-0.1t}$.

1. Find and interpret $T(0)$.
2. Sketch the graph of $y = T(t)$ using transformations.
3. Find and interpret the horizontal asymptote of the graph.

Solution.

1. To find $T(0)$, we replace every occurrence of the independent variable t with 0 to obtain $T(0) = 70 + 90e^{-0.1(0)} = 160$. This means that the coffee was served at 160°F.
2. To graph $y = T(t)$ using transformations, we start with the basic function, $f(t) = e^t$. As we have already remarked, $e \approx 2.718 > 1$ so the graph of f is an increasing exponential with y -intercept $(0, 1)$ and horizontal asymptote $y = 0$. The points $(-1, e^{-1}) \approx (-1, 0.37)$ and $(1, e) \approx (1, 2.72)$ are also on the graph. Since the formula $T(t)$ looks rather complicated, we rewrite $T(t)$ in the form presented in Theorem 1.7 and use that result to track the changes to our three points and the horizontal asymptote. We have

$$T(t) = 70 + 90e^{-0.1t} = 90e^{-0.1t} + 70 = 90f(-0.1t) + 70$$

Multiplication of the input to f , t , by -0.1 results in a horizontal expansion by a factor of 10 as well as a reflection about the y -axis. We divide each of the x values of our points by -0.1 (which amounts to multiplying them by -10) to obtain $(10, e^{-1})$, $(0, 1)$, and $(-10, e)$. Since none of these changes affected the y values, the horizontal asymptote remains $y = 0$. Next, we see that the output from f is being multiplied by 90. This results in a vertical stretch by a factor of 90. We multiply the y -coordinates by 90 to obtain $(10, 90e^{-1})$, $(0, 90)$, and $(-10, 90e)$. We also multiply the y value of the horizontal asymptote $y = 0$ by 90, and it remains $y = 0$. Finally, we add 70 to all of the y -coordinates, which shifts the graph upwards to obtain $(10, 90e^{-1} + 70) \approx (10, 103.11)$, $(0, 160)$, and $(-10, 90e + 70) \approx (-10, 314.64)$. Adding 70 to the horizontal asymptote shifts it upwards as well to $y = 70$. We connect these three points using the same shape in the same direction as in the graph of f and, last but not least, we restrict the domain to match the applied domain $[0, \infty)$. The result is below.

⁸We will discuss this in greater detail in Section 6.5.

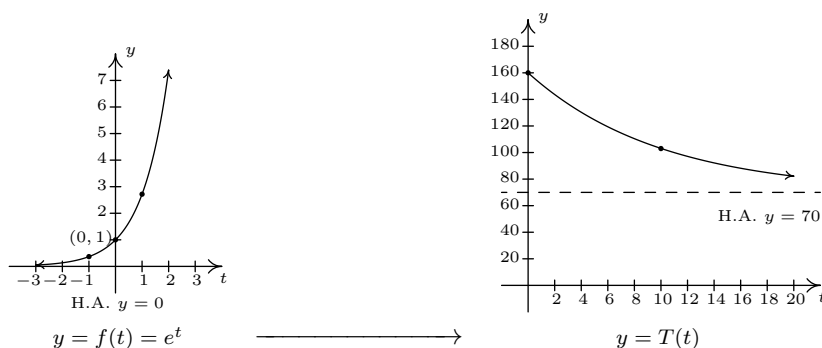

3. From the graph, we see that the horizontal asymptote is $y = 70$. It is worth a moment or two of our time to see how this happens analytically and to review some of the ‘number sense’ developed in Chapter 4. As $t \rightarrow \infty$, We get $T(t) = 70 + 90e^{-0.1t} \approx 70 + 90e^{\text{very big } (-)}$. Since $e > 1$,

$$e^{\text{very big } (-)} = \frac{1}{e^{\text{very big } (+)}} \approx \frac{1}{\text{very big } (+)} \approx \text{very small } (+)$$

The larger t becomes, the smaller $e^{-0.1t}$ becomes, so the term $90e^{-0.1t} \approx \text{very small } (+)$. Hence, $T(t) \approx 70 + \text{very small } (+)$ which means the graph is approaching the horizontal line $y = 70$ from above. This means that as time goes by, the temperature of the coffee is cooling to 70°F , presumably room temperature. \square

As we have already remarked, the graphs of $f(x) = b^x$ all pass the Horizontal Line Test. Thus the exponential functions are invertible. We now turn our attention to these inverses, the logarithmic functions, which are called ‘logs’ for short.

Definition 6.2. The inverse of the exponential function $f(x) = b^x$ is called the **base b logarithm function**, and is denoted $f^{-1}(x) = \log_b(x)$. We read ‘ $\log_b(x)$ ’ as ‘log base b of x .’

We have special notations for the common base, $b = 10$, and the natural base, $b = e$.

Definition 6.3. The **common logarithm** of a real number x is $\log_{10}(x)$ and is usually written $\log(x)$. The **natural logarithm** of a real number x is $\log_e(x)$ and is usually written $\ln(x)$.

Since logs are defined as the inverses of exponential functions, we can use Theorems 5.2 and 5.3 to tell us about logarithmic functions. For example, we know that the domain of a log function is the range of an exponential function, namely $(0, \infty)$, and that the range of a log function is the domain of an exponential function, namely $(-\infty, \infty)$. Since we know the basic shapes of $y = f(x) = b^x$ for the different cases of b , we can obtain the graph of $y = f^{-1}(x) = \log_b(x)$ by reflecting the graph of f across the line $y = x$ as shown below. The y -intercept $(0, 1)$ on the graph of f corresponds to an x -intercept of $(1, 0)$ on the graph of f^{-1} . The horizontal asymptotes $y = 0$ on the graphs of the exponential functions become vertical asymptotes $x = 0$ on the log graphs.

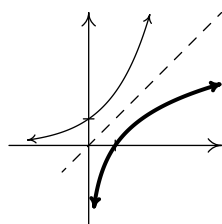

$$y = b^x, b > 1$$

$$y = \log_b(x), b > 1$$

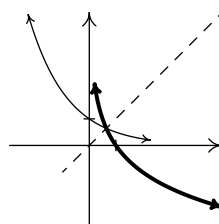

$$y = b^x, 0 < b < 1$$

$$y = \log_b(x), 0 < b < 1$$

On a procedural level, logs undo the exponentials. Consider the function $f(x) = 2^x$. When we evaluate $f(3) = 2^3 = 8$, the input 3 becomes the exponent on the base 2 to produce the real number 8. The function $f^{-1}(x) = \log_2(x)$ then takes the number 8 as its input and returns the exponent 3 as its output. In symbols, $\log_2(8) = 3$. More generally, $\log_2(x)$ is the exponent you put on 2 to get x . Thus, $\log_2(16) = 4$, because $2^4 = 16$. The following theorem summarizes the basic properties of logarithmic functions, all of which come from the fact that they are inverses of exponential functions.

Theorem 6.2. Properties of Logarithmic Functions: Suppose $f(x) = \log_b(x)$.

- The domain of f is $(0, \infty)$ and the range of f is $(-\infty, \infty)$.
 - $(1, 0)$ is on the graph of f and $x = 0$ is a vertical asymptote of the graph of f .
 - f is one-to-one, continuous and smooth
 - $b^a = c$ if and only if $\log_b(c) = a$. That is, $\log_b(c)$ is the exponent you put on b to obtain c .
 - $\log_b(b^x) = x$ for all x and $b^{\log_b(x)} = x$ for all $x > 0$
- | | |
|--|---|
| <ul style="list-style-type: none"> • If $b > 1$: <ul style="list-style-type: none"> – f is always increasing – As $x \rightarrow 0^+$, $f(x) \rightarrow -\infty$ – As $x \rightarrow \infty$, $f(x) \rightarrow \infty$ – The graph of f resembles: | <ul style="list-style-type: none"> • If $0 < b < 1$: <ul style="list-style-type: none"> – f is always decreasing – As $x \rightarrow 0^+$, $f(x) \rightarrow \infty$ – As $x \rightarrow \infty$, $f(x) \rightarrow -\infty$ – The graph of f resembles: |
|--|---|

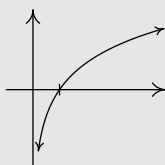

$$y = \log_b(x), b > 1$$

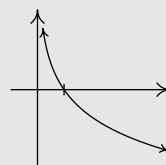

$$y = \log_b(x), 0 < b < 1$$

As we have mentioned, Theorem 6.2 is a consequence of Theorems 5.2 and 5.3. However, it is worth the reader's time to understand Theorem 6.2 from an exponential perspective. For instance, we know that the domain of $g(x) = \log_2(x)$ is $(0, \infty)$. Why? Because the range of $f(x) = 2^x$ is $(0, \infty)$. In a way, this says everything, but at the same time, it doesn't. For example, if we try to find $\log_2(-1)$, we are trying to find the exponent we put on 2 to give us -1 . In other words, we are looking for x that satisfies $2^x = -1$. There is no such real number, since all powers of 2 are positive. While what we have said is exactly the same thing as saying 'the domain of $g(x) = \log_2(x)$ is $(0, \infty)$ because the range of $f(x) = 2^x$ is $(0, \infty)$ ', we feel it is in a student's best interest to understand the statements in Theorem 6.2 at this level instead of just merely memorizing the facts.

Example 6.1.3. Simplify the following.

- | | | | |
|------------------|-------------------------------------|---------------------------|------------------------------------|
| 1. $\log_3(81)$ | 2. $\log_2\left(\frac{1}{8}\right)$ | 3. $\log_{\sqrt{5}}(25)$ | 4. $\ln\left(\sqrt[3]{e^2}\right)$ |
| 5. $\log(0.001)$ | 6. $2^{\log_2(8)}$ | 7. $117^{-\log_{117}(6)}$ | |

Solution.

- The number $\log_3(81)$ is the exponent we put on 3 to get 81. As such, we want to write 81 as a power of 3. We find $81 = 3^4$, so that $\log_3(81) = 4$.
- To find $\log_2\left(\frac{1}{8}\right)$, we need rewrite $\frac{1}{8}$ as a power of 2. We find $\frac{1}{8} = \frac{1}{2^3} = 2^{-3}$, so $\log_2\left(\frac{1}{8}\right) = -3$.
- To determine $\log_{\sqrt{5}}(25)$, we need to express 25 as a power of $\sqrt{5}$. We know $25 = 5^2$, and $5 = (\sqrt{5})^2$, so we have $25 = \left((\sqrt{5})^2\right)^2 = (\sqrt{5})^4$. We get $\log_{\sqrt{5}}(25) = 4$.
- First, recall that the notation $\ln\left(\sqrt[3]{e^2}\right)$ means $\log_e\left(\sqrt[3]{e^2}\right)$, so we are looking for the exponent to put on e to obtain $\sqrt[3]{e^2}$. Rewriting $\sqrt[3]{e^2} = e^{2/3}$, we find $\ln\left(\sqrt[3]{e^2}\right) = \ln\left(e^{2/3}\right) = \frac{2}{3}$.
- Rewriting $\log(0.001)$ as $\log_{10}(0.001)$, we see that we need to write 0.001 as a power of 10. We have $0.001 = \frac{1}{1000} = \frac{1}{10^3} = 10^{-3}$. Hence, $\log(0.001) = \log(10^{-3}) = -3$.
- We can use Theorem 6.2 directly to simplify $2^{\log_2(8)} = 8$. We can also understand this problem by first finding $\log_2(8)$. By definition, $\log_2(8)$ is the exponent we put on 2 to get 8. Since $8 = 2^3$, we have $\log_2(8) = 3$. We now substitute to find $2^{\log_2(8)} = 2^3 = 8$.
- From Theorem 6.2, we know $117^{\log_{117}(6)} = 6$, but we cannot directly apply this formula to the expression $117^{-\log_{117}(6)}$. (Can you see why?) At this point, we use a property of exponents followed by Theorem 6.2 to get⁹

$$117^{-\log_{117}(6)} = \frac{1}{117^{\log_{117}(6)}} = \frac{1}{6}$$

□

⁹It is worth a moment of your time to think your way through why $117^{\log_{117}(6)} = 6$. By definition, $\log_{117}(6)$ is the exponent we put on 117 to get 6. What are we doing with this exponent? We are putting it on 117. By definition we get 6. In other words, the exponential function $f(x) = 117^x$ undoes the logarithmic function $g(x) = \log_{117}(x)$.

Up until this point, restrictions on the domains of functions came from avoiding division by zero and keeping negative numbers from beneath even radicals. With the introduction of logs, we now have another restriction. Since the domain of $f(x) = \log_b(x)$ is $(0, \infty)$, the argument¹⁰ of the log must be strictly positive.

Example 6.1.4. Find the domain of the following functions. Check your answers graphically using the calculator.

1. $f(x) = 2\log(3 - x) - 1$

2. $g(x) = \ln\left(\frac{x}{x-1}\right)$

Solution.

- We set $3 - x > 0$ to obtain $x < 3$, or $(-\infty, 3)$. The graph from the calculator below verifies this. Note that we could have graphed f using transformations. Taking a cue from Theorem 1.7, we rewrite $f(x) = 2\log_{10}(-x + 3) - 1$ and find the main function involved is $y = h(x) = \log_{10}(x)$. We select three points to track, $(\frac{1}{10}, -1)$, $(1, 0)$ and $(10, 1)$, along with the vertical asymptote $x = 0$. Since $f(x) = 2h(-x + 3) - 1$, Theorem 1.7 tells us that to obtain the destinations of these points, we first subtract 3 from the x -coordinates (shifting the graph left 3 units), then divide (multiply) by the x -coordinates by -1 (causing a reflection across the y -axis). These transformations apply to the vertical asymptote $x = 0$ as well. Subtracting 3 gives us $x = -3$ as our asymptote, then multiplying by -1 gives us the vertical asymptote $x = 3$. Next, we multiply the y -coordinates by 2 which results in a vertical stretch by a factor of 2, then we finish by subtracting 1 from the y -coordinates which shifts the graph down 1 unit. We leave it to the reader to perform the indicated arithmetic on the points themselves and to verify the graph produced by the calculator below.
- To find the domain of g , we need to solve the inequality $\frac{x}{x-1} > 0$. As usual, we proceed using a sign diagram. If we define $r(x) = \frac{x}{x-1}$, we find r is undefined at $x = 1$ and $r(x) = 0$ when $x = 0$. Choosing some test values, we generate the sign diagram below.

$$\begin{array}{ccccccc} & (+) & 0 & (-) & ? & (+) & \\ & & | & & | & & \\ \leftarrow & & \frac{x}{x-1} & & & & \rightarrow \\ & & 0 & & 1 & & \end{array}$$

We find $\frac{x}{x-1} > 0$ on $(-\infty, 0) \cup (1, \infty)$ to get the domain of g . The graph of $y = g(x)$ confirms this. We can tell from the graph of g that it is not the result of Section 1.7 transformations being applied to the graph $y = \ln(x)$, so barring a more detailed analysis using Calculus, the calculator graph is the best we can do. One thing worthy of note, however, is the end behavior of g . The graph suggests that as $x \rightarrow \pm\infty$, $g(x) \rightarrow 0$. We can verify this analytically. Using results from Chapter 4 and continuity, we know that as $x \rightarrow \pm\infty$, $\frac{x}{x-1} \approx 1$. Hence, it makes sense that $g(x) = \ln\left(\frac{x}{x-1}\right) \approx \ln(1) = 0$.

¹⁰See page 189 if you've forgotten what this term means.

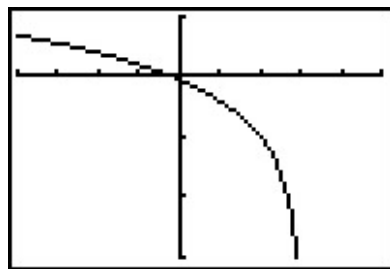

$$y = f(x) = 2 \log(3 - x) - 1$$

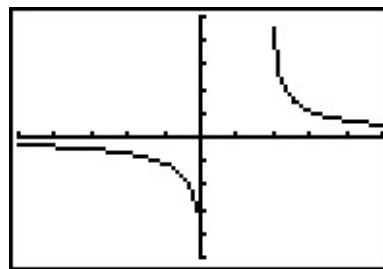

$$y = g(x) = \ln \left(\frac{x}{x-1} \right)$$

□

While logarithms have some interesting applications of their own which you'll explore in the exercises, their primary use to us will be to undo exponential functions. (This is, after all, how they were defined.) Our last example solidifies this and reviews all of the material in the section.

Example 6.1.5. Let $f(x) = 2^{x-1} - 3$.

1. Graph f using transformations and state the domain and range of f .
2. Explain why f is invertible and find a formula for $f^{-1}(x)$.
3. Graph f^{-1} using transformations and state the domain and range of f^{-1} .
4. Verify $(f^{-1} \circ f)(x) = x$ for all x in the domain of f and $(f \circ f^{-1})(x) = x$ for all x in the domain of f^{-1} .
5. Graph f and f^{-1} on the same set of axes and check the symmetry about the line $y = x$.

Solution.

1. If we identify $g(x) = 2^x$, we see $f(x) = g(x-1) - 3$. We pick the points $(-1, \frac{1}{2})$, $(0, 1)$ and $(1, 2)$ on the graph of g along with the horizontal asymptote $y = 0$ to track through the transformations. By Theorem 1.7 we first add 1 to the x -coordinates of the points on the graph of g (shifting g to the right 1 unit) to get $(0, \frac{1}{2})$, $(1, 1)$ and $(2, 2)$. The horizontal asymptote remains $y = 0$. Next, we subtract 3 from the y -coordinates, shifting the graph down 3 units. We get the points $(0, -\frac{5}{2})$, $(1, -2)$ and $(2, -1)$ with the horizontal asymptote now at $y = -3$. Connecting the dots in the order and manner as they were on the graph of g , we get the graph below. We see that the domain of f is the same as g , namely $(-\infty, \infty)$, but that the range of f is $(-3, \infty)$.

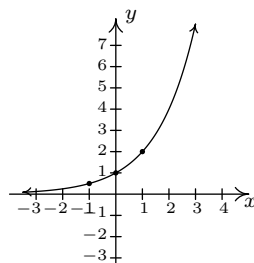

$$y = h(x) = 2^x$$

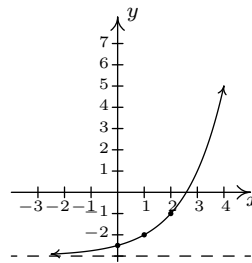

$$y = f(x) = 2^{x-1} - 3$$

2. The graph of f passes the Horizontal Line Test so f is one-to-one, hence invertible. To find a formula for $f^{-1}(x)$, we normally set $y = f(x)$, interchange the x and y , then proceed to solve for y . Doing so in this situation leads us to the equation $x = 2^{y-1} - 3$. We have yet to discuss how to solve this kind of equation, so we will attempt to find the formula for f^{-1} from a procedural perspective. If we break $f(x) = 2^{x-1} - 3$ into a series of steps, we find f takes an input x and applies the steps

- (a) subtract 1
- (b) put as an exponent on 2
- (c) subtract 3

Clearly, to undo subtracting 1, we will add 1, and similarly we undo subtracting 3 by adding 3. How do we undo the second step? The answer is we use the logarithm. By definition, $\log_2(x)$ undoes exponentiation by 2. Hence, f^{-1} should

- (a) add 3
- (b) take the logarithm base 2
- (c) add 1

In symbols, $f^{-1}(x) = \log_2(x + 3) + 1$.

3. To graph $f^{-1}(x) = \log_2(x + 3) + 1$ using transformations, we start with $j(x) = \log_2(x)$. We track the points $(\frac{1}{2}, -1)$, $(1, 0)$ and $(2, 1)$ on the graph of j along with the vertical asymptote $x = 0$ through the transformations using Theorem 1.7. Since $f^{-1}(x) = j(x + 3) + 1$, we first subtract 3 from each of the x values (including the vertical asymptote) to obtain $(-\frac{5}{2}, -1)$, $(-2, 0)$ and $(-1, 1)$ with a vertical asymptote $x = -3$. Next, we add 1 to the y values on the graph and get $(-\frac{5}{2}, 0)$, $(-2, 1)$ and $(-1, 2)$. If you are experiencing *déjà vu*, there is a good reason for it but we leave it to the reader to determine the source of this uncanny familiarity. We obtain the graph below. The domain of f^{-1} is $(-3, \infty)$, which matches the range of f , and the range of f^{-1} is $(-\infty, \infty)$, which matches the domain of f .

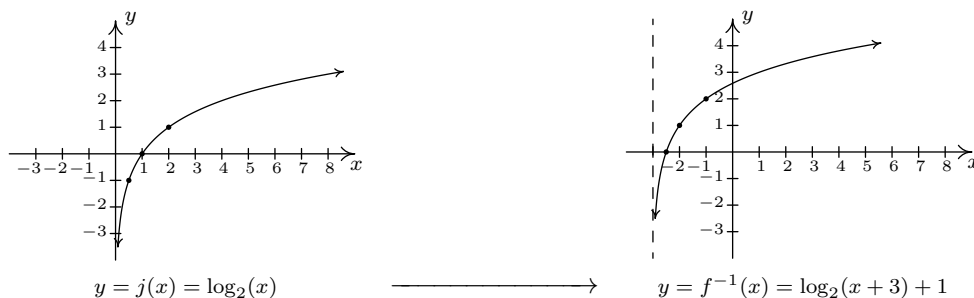

4. We now verify that $f(x) = 2^{x-1} - 3$ and $f^{-1}(x) = \log_2(x + 3) + 1$ satisfy the composition requirement for inverses. For all real numbers x ,

$$\begin{aligned}
(f^{-1} \circ f)(x) &= f^{-1}(f(x)) \\
&= f^{-1}(2^{x-1} - 3) \\
&= \log_2([2^{x-1} - 3] + 3) + 1 \\
&= \log_2(2^{x-1}) + 1 \\
&= (x - 1) + 1 && \text{Since } \log_2(2^u) = u \text{ for all real numbers } u \\
&= x \checkmark
\end{aligned}$$

For all real numbers $x > -3$, we have¹¹

$$\begin{aligned}
(f \circ f^{-1})(x) &= f(f^{-1}(x)) \\
&= f(\log_2(x + 3) + 1) \\
&= 2^{(\log_2(x+3)+1)-1} - 3 \\
&= 2^{\log_2(x+3)} - 3 \\
&= (x + 3) - 3 && \text{Since } 2^{\log_2(u)} = u \text{ for all real numbers } u > 0 \\
&= x \checkmark
\end{aligned}$$

5. Last, but certainly not least, we graph $y = f(x)$ and $y = f^{-1}(x)$ on the same set of axes and see the symmetry about the line $y = x$.

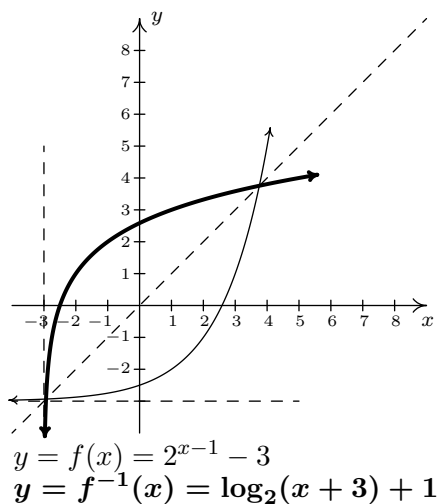

□

¹¹Pay attention - can you spot in which step below we need $x > -3$?

6.1.1 EXERCISES

In Exercises 1 - 15, use the property: $b^a = c$ if and only if $\log_b(c) = a$ from Theorem 6.2 to rewrite the given equation in the other form. That is, rewrite the exponential equations as logarithmic equations and rewrite the logarithmic equations as exponential equations.

1. $2^3 = 8$

2. $5^{-3} = \frac{1}{125}$

3. $4^{5/2} = 32$

4. $\left(\frac{1}{3}\right)^{-2} = 9$

5. $\left(\frac{4}{25}\right)^{-1/2} = \frac{5}{2}$

6. $10^{-3} = 0.001$

7. $e^0 = 1$

8. $\log_5(25) = 2$

9. $\log_{25}(5) = \frac{1}{2}$

10. $\log_3\left(\frac{1}{81}\right) = -4$

11. $\log_{\frac{4}{3}}\left(\frac{3}{4}\right) = -1$

12. $\log(100) = 2$

13. $\log(0.1) = -1$

14. $\ln(e) = 1$

15. $\ln\left(\frac{1}{\sqrt{e}}\right) = -\frac{1}{2}$

In Exercises 16 - 42, evaluate the expression.

16. $\log_3(27)$

17. $\log_6(216)$

18. $\log_2(32)$

19. $\log_6\left(\frac{1}{36}\right)$

20. $\log_8(4)$

21. $\log_{36}(216)$

22. $\log_{\frac{1}{5}}(625)$

23. $\log_{\frac{1}{6}}(216)$

24. $\log_{36}(36)$

25. $\log\left(\frac{1}{1000000}\right)$

26. $\log(0.01)$

27. $\ln(e^3)$

28. $\log_4(8)$

29. $\log_6(1)$

30. $\log_{13}(\sqrt{13})$

31. $\log_{36}\left(\sqrt[4]{36}\right)$

32. $7^{\log_7(3)}$

33. $36^{\log_{36}(216)}$

34. $\log_{36}\left(36^{216}\right)$

35. $\ln(e^5)$

36. $\log\left(\sqrt[9]{10^{11}}\right)$

37. $\log\left(\sqrt[3]{10^5}\right)$

38. $\ln\left(\frac{1}{\sqrt{e}}\right)$

39. $\log_5\left(3^{\log_3(5)}\right)$

40. $\log\left(e^{\ln(100)}\right)$

41. $\log_2\left(3^{-\log_3(2)}\right)$

42. $\ln\left(42^{6\log(1)}\right)$

In Exercises 43 - 57, find the domain of the function.

43. $f(x) = \ln(x^2 + 1)$

44. $f(x) = \log_7(4x + 8)$

45. $f(x) = \ln(4x - 20)$

46. $f(x) = \log(x^2 + 9x + 18)$

47. $f(x) = \log\left(\frac{x+2}{x^2-1}\right)$

48. $f(x) = \log\left(\frac{x^2+9x+18}{4x-20}\right)$

49. $f(x) = \ln(7-x) + \ln(x-4)$

50. $f(x) = \ln(4x-20) + \ln(x^2+9x+18)$

51. $f(x) = \log(x^2+x+1)$

52. $f(x) = \sqrt[4]{\log_4(x)}$

53. $f(x) = \log_9(|x+3|-4)$

54. $f(x) = \ln(\sqrt{x-4}-3)$

55. $f(x) = \frac{1}{3 - \log_5(x)}$

56. $f(x) = \frac{\sqrt{-1-x}}{\log_{\frac{1}{2}}(x)}$

57. $f(x) = \ln(-2x^3 - x^2 + 13x - 6)$

In Exercises 58 - 63, sketch the graph of $y = g(x)$ by starting with the graph of $y = f(x)$ and using transformations. Track at least three points of your choice and the horizontal asymptote through the transformations. State the domain and range of g .

58. $f(x) = 2^x, g(x) = 2^x - 1$

59. $f(x) = \left(\frac{1}{3}\right)^x, g(x) = \left(\frac{1}{3}\right)^{x-1}$

60. $f(x) = 3^x, g(x) = 3^{-x} + 2$

61. $f(x) = 10^x, g(x) = 10^{\frac{x+1}{2}} - 20$

62. $f(x) = e^x, g(x) = 8 - e^{-x}$

63. $f(x) = e^x, g(x) = 10e^{-0.1x}$

In Exercises 64 - 69, sketch the graph of $y = g(x)$ by starting with the graph of $y = f(x)$ and using transformations. Track at least three points of your choice and the vertical asymptote through the transformations. State the domain and range of g .

64. $f(x) = \log_2(x), g(x) = \log_2(x+1)$

65. $f(x) = \log_{\frac{1}{3}}(x), g(x) = \log_{\frac{1}{3}}(x) + 1$

66. $f(x) = \log_3(x), g(x) = -\log_3(x-2)$

67. $f(x) = \log(x), g(x) = 2\log(x+20) - 1$

68. $f(x) = \ln(x), g(x) = -\ln(8-x)$

69. $f(x) = \ln(x), g(x) = -10\ln\left(\frac{x}{10}\right)$

70. Verify that each function in Exercises 64 - 69 is the inverse of the corresponding function in Exercises 58 - 63. (Match up #58 and #64, and so on.)

In Exercises 71 - 74, find the inverse of the function from the 'procedural perspective' discussed in Example 6.1.5 and graph the function and its inverse on the same set of axes.

71. $f(x) = 3^{x+2} - 4$

72. $f(x) = \log_4(x-1)$

73. $f(x) = -2^{-x} + 1$

74. $f(x) = 5\log(x) - 2$

(Logarithmic Scales) In Exercises 75 - 77, we introduce three widely used measurement scales which involve common logarithms: the Richter scale, the decibel scale and the pH scale. The computations involved in all three scales are nearly identical so pay attention to the subtle differences.

75. Earthquakes are complicated events and it is not our intent to provide a complete discussion of the science involved in them. Instead, we refer the interested reader to a solid course in Geology¹² or the U.S. Geological Survey's Earthquake Hazards Program found [here](#) and present only a simplified version of the [Richter scale](#). The Richter scale measures the magnitude of an earthquake by comparing the amplitude of the seismic waves of the given earthquake to those of a "magnitude 0 event", which was chosen to be a seismograph reading of 0.001 millimeters recorded on a seismometer 100 kilometers from the earthquake's epicenter. Specifically, the magnitude of an earthquake is given by

$$M(x) = \log\left(\frac{x}{0.001}\right)$$

where x is the seismograph reading in millimeters of the earthquake recorded 100 kilometers from the epicenter.

- (a) Show that $M(0.001) = 0$.
 - (b) Compute $M(80,000)$.
 - (c) Show that an earthquake which registered 6.7 on the Richter scale had a seismograph reading ten times larger than one which measured 5.7.
 - (d) Find two news stories about recent earthquakes which give their magnitudes on the Richter scale. How many times larger was the seismograph reading of the earthquake with larger magnitude?
76. While the decibel scale can be used in many disciplines,¹³ we shall restrict our attention to its use in acoustics, specifically its use in measuring the intensity level of sound.¹⁴ The Sound Intensity Level L (measured in decibels) of a sound intensity I (measured in watts per square meter) is given by

$$L(I) = 10 \log\left(\frac{I}{10^{-12}}\right).$$

Like the Richter scale, this scale compares I to baseline: $10^{-12} \frac{W}{m^2}$ is the threshold of human hearing.

- (a) Compute $L(10^{-6})$.

¹²Rock-solid, perhaps?

¹³See this [webpage](#) for more information.

¹⁴As of the writing of this exercise, the Wikipedia page given [here](#) states that it may not meet the "general notability guideline" nor does it cite any references or sources. I find this odd because it is this very usage of the decibel scale which shows up in every College Algebra book I have read. Perhaps those other books have been wrong all along and we're just blindly following tradition.

- (b) Damage to your hearing can start with short term exposure to sound levels around 115 decibels. What intensity I is needed to produce this level?
- (c) Compute $L(1)$. How does this compare with the threshold of pain which is around 140 decibels?
77. The pH of a solution is a measure of its acidity or alkalinity. Specifically, $\text{pH} = -\log[\text{H}^+]$ where $[\text{H}^+]$ is the hydrogen ion concentration in moles per liter. A solution with a pH less than 7 is an acid, one with a pH greater than 7 is a base (alkaline) and a pH of 7 is regarded as neutral.
- (a) The hydrogen ion concentration of pure water is $[\text{H}^+] = 10^{-7}$. Find its pH.
- (b) Find the pH of a solution with $[\text{H}^+] = 6.3 \times 10^{-13}$.
- (c) The pH of gastric acid (the acid in your stomach) is about 0.7. What is the corresponding hydrogen ion concentration?
78. Show that $\log_b 1 = 0$ and $\log_b b = 1$ for every $b > 0$, $b \neq 1$.
79. (Crazy bonus question) Without using your calculator, determine which is larger: e^π or π^e .

6.1.2 ANSWERS

1. $\log_2(8) = 3$
2. $\log_5\left(\frac{1}{125}\right) = -3$
3. $\log_4(32) = \frac{5}{2}$
4. $\log_{\frac{1}{3}}(9) = -2$
5. $\log_{\frac{4}{25}}\left(\frac{5}{2}\right) = -\frac{1}{2}$
6. $\log(0.001) = -3$
7. $\ln(1) = 0$
8. $5^2 = 25$
9. $(25)^{\frac{1}{2}} = 5$
10. $3^{-4} = \frac{1}{81}$
11. $\left(\frac{4}{3}\right)^{-1} = \frac{3}{4}$
12. $10^2 = 100$
13. $10^{-1} = 0.1$
14. $e^1 = e$
15. $e^{-\frac{1}{2}} = \frac{1}{\sqrt{e}}$
16. $\log_3(27) = 3$
17. $\log_6(216) = 3$
18. $\log_2(32) = 5$
19. $\log_6\left(\frac{1}{36}\right) = -2$
20. $\log_8(4) = \frac{2}{3}$
21. $\log_{36}(216) = \frac{3}{2}$
22. $\log_{\frac{1}{5}}(625) = -4$
23. $\log_{\frac{1}{6}}(216) = -3$
24. $\log_{36}(36) = 1$
25. $\log\frac{1}{1000000} = -6$
26. $\log(0.01) = -2$
27. $\ln(e^3) = 3$
28. $\log_4(8) = \frac{3}{2}$
29. $\log_6(1) = 0$
30. $\log_{13}(\sqrt{13}) = \frac{1}{2}$
31. $\log_{36}(\sqrt[4]{36}) = \frac{1}{4}$
32. $7^{\log_7(3)} = 3$
33. $36^{\log_{36}(216)} = 216$
34. $\log_{36}(36^{216}) = 216$
35. $\ln(e^5) = 5$
36. $\log\left(\sqrt[9]{10^{11}}\right) = \frac{11}{9}$
37. $\log\left(\sqrt[3]{10^5}\right) = \frac{5}{3}$
38. $\ln\left(\frac{1}{\sqrt{e}}\right) = -\frac{1}{2}$
39. $\log_5(3^{\log_3 5}) = 1$
40. $\log(e^{\ln(100)}) = 2$
41. $\log_2(3^{-\log_3(2)}) = -1$
42. $\ln(42^{6\log(1)}) = 0$
43. $(-\infty, \infty)$
44. $(-2, \infty)$
45. $(5, \infty)$
46. $(-\infty, -6) \cup (-3, \infty)$
47. $(-2, -1) \cup (1, \infty)$
48. $(-6, -3) \cup (5, \infty)$
49. $(4, 7)$
50. $(5, \infty)$
51. $(-\infty, \infty)$
52. $[1, \infty)$
53. $(-\infty, -7) \cup (1, \infty)$
54. $(13, \infty)$
55. $(0, 125) \cup (125, \infty)$
56. No domain
57. $(-\infty, -3) \cup \left(\frac{1}{2}, 2\right)$

58. Domain of g : $(-\infty, \infty)$
Range of g : $(-1, \infty)$

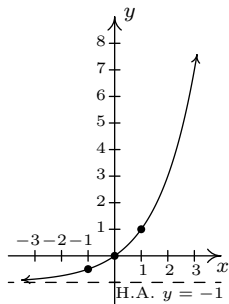

$$y = g(x) = 2^x - 1$$

59. Domain of g : $(-\infty, \infty)$
Range of g : $(0, \infty)$

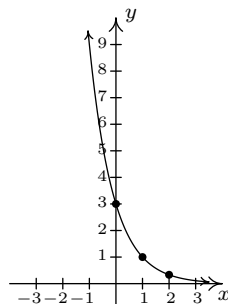

$$y = g(x) = \left(\frac{1}{3}\right)^{x-1}$$

60. Domain of g : $(-\infty, \infty)$
Range of g : $(2, \infty)$

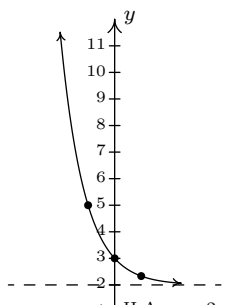

$$y = g(x) = 3^{-x} + 2$$

61. Domain of g : $(-\infty, \infty)$
Range of g : $(-20, \infty)$

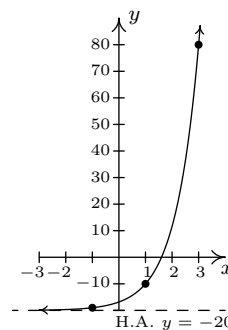

$$y = g(x) = 10^{\frac{x+1}{2}} - 20$$

62. Domain of g : $(-\infty, \infty)$
Range of g : $(-\infty, 8)$

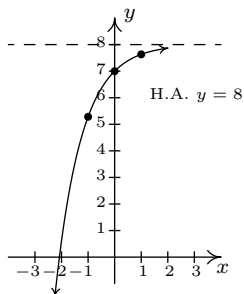

$$y = g(x) = 8 - e^{-x}$$

63. Domain of g : $(-\infty, \infty)$
Range of g : $(0, \infty)$

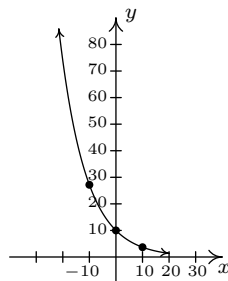

$$y = g(x) = 10e^{-0.1x}$$

64. Domain of g : $(-1, \infty)$
 Range of g : $(-\infty, \infty)$

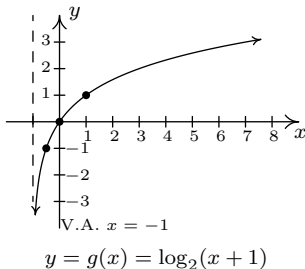

65. Domain of g : $(0, \infty)$
 Range of g : $(-\infty, \infty)$

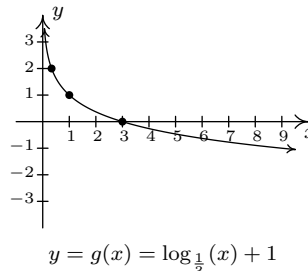

66. Domain of g : $(2, \infty)$
 Range of g : $(-\infty, \infty)$

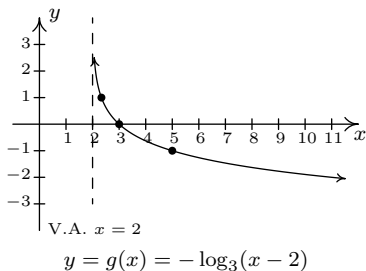

67. Domain of g : $(-20, \infty)$
 Range of g : $(-\infty, \infty)$

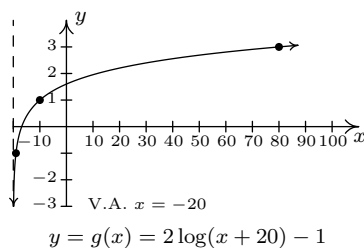

68. Domain of g : $(-\infty, 8)$
 Range of g : $(-\infty, \infty)$

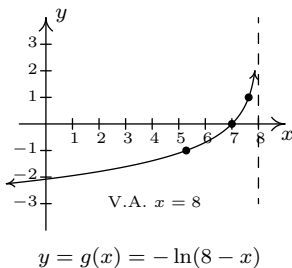

69. Domain of g : $(0, \infty)$
 Range of g : $(-\infty, \infty)$

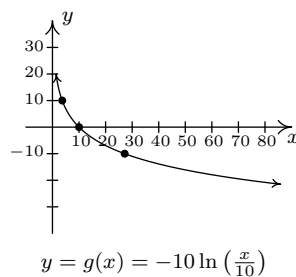

$$71. \quad f(x) = 3^{x+2} - 4$$

$$f^{-1}(x) = \log_3(x+4) - 2$$

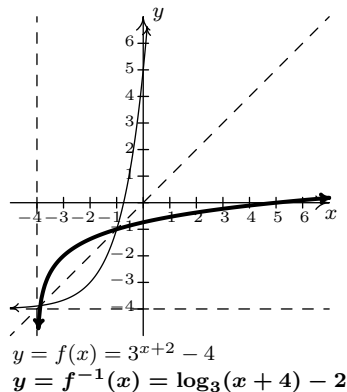

$$72. \quad f(x) = \log_4(x-1)$$

$$f^{-1}(x) = 4^x + 1$$

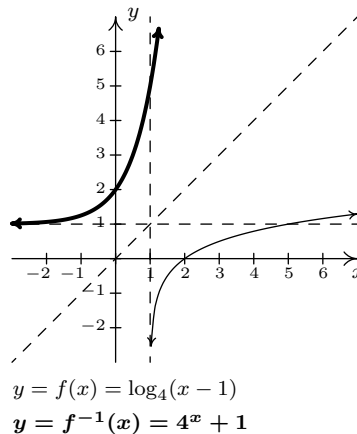

$$73. \quad f(x) = -2^{-x} + 1$$

$$f^{-1}(x) = -\log_2(1-x)$$

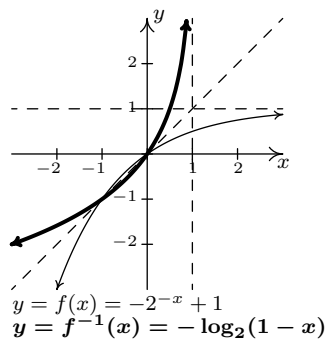

$$74. \quad f(x) = 5 \log(x) - 2$$

$$f^{-1}(x) = 10^{\frac{x+2}{5}}$$

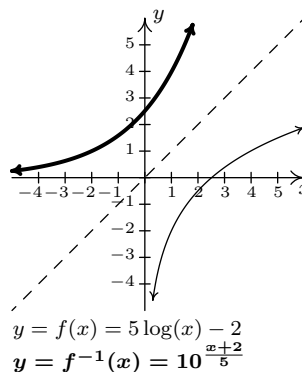

$$75. \quad (a) \quad M(0.001) = \log\left(\frac{0.001}{0.001}\right) = \log(1) = 0.$$

$$(b) \quad M(80,000) = \log\left(\frac{80,000}{0.001}\right) = \log(80,000,000) \approx 7.9.$$

$$76. \quad (a) \quad L(10^{-6}) = 60 \text{ decibels.}$$

$$(b) \quad I = 10^{-5} \approx 0.316 \text{ watts per square meter.}$$

(c) Since $L(1) = 120$ decibels and $L(100) = 140$ decibels, a sound with intensity level 140 decibels has an intensity 100 times greater than a sound with intensity level 120 decibels.

$$77. \quad (a) \quad \text{The pH of pure water is 7.}$$

$$(b) \quad \text{If } [H^+] = 6.3 \times 10^{-13} \text{ then the solution has a pH of 12.2.}$$

$$(c) \quad [H^+] = 10^{-0.7} \approx .1995 \text{ moles per liter.}$$

6.2 PROPERTIES OF LOGARITHMS

In Section 6.1, we introduced the logarithmic functions as inverses of exponential functions and discussed a few of their functional properties from that perspective. In this section, we explore the algebraic properties of logarithms. Historically, these have played a huge role in the scientific development of our society since, among other things, they were used to develop analog computing devices called [slide rules](#) which enabled scientists and engineers to perform accurate calculations leading to such things as space travel and the [moon landing](#). As we shall see shortly, logs inherit analogs of all of the properties of exponents you learned in Elementary and Intermediate Algebra. We first extract two properties from Theorem 6.2 to remind us of the definition of a logarithm as the inverse of an exponential function.

Theorem 6.3. (Inverse Properties of Exponential and Logarithmic Functions)

Let $b > 0$, $b \neq 1$.

- $b^a = c$ if and only if $\log_b(c) = a$
- $\log_b(b^x) = x$ for all x and $b^{\log_b(x)} = x$ for all $x > 0$

Next, we spell out what it means for exponential and logarithmic functions to be one-to-one.

Theorem 6.4. (One-to-one Properties of Exponential and Logarithmic Functions)

Let $f(x) = b^x$ and $g(x) = \log_b(x)$ where $b > 0$, $b \neq 1$. Then f and g are one-to-one and

- $b^u = b^w$ if and only if $u = w$ for all real numbers u and w .
- $\log_b(u) = \log_b(w)$ if and only if $u = w$ for all real numbers $u > 0$, $w > 0$.

We now state the algebraic properties of exponential functions which will serve as a basis for the properties of logarithms. While these properties may look identical to the ones you learned in Elementary and Intermediate Algebra, they apply to real number exponents, not just rational exponents. Note that in the theorem that follows, we are interested in the properties of exponential functions, so the base b is restricted to $b > 0$, $b \neq 1$. An added benefit of this restriction is that it eliminates the pathologies discussed in Section 5.3 when, for example, we simplified $(x^{2/3})^{3/2}$ and obtained $|x|$ instead of what we had expected from the arithmetic in the exponents, $x^1 = x$.

Theorem 6.5. (Algebraic Properties of Exponential Functions) Let $f(x) = b^x$ be an exponential function ($b > 0$, $b \neq 1$) and let u and w be real numbers.

- **Product Rule:** $f(u + w) = f(u)f(w)$. In other words, $b^{u+w} = b^u b^w$
- **Quotient Rule:** $f(u - w) = \frac{f(u)}{f(w)}$. In other words, $b^{u-w} = \frac{b^u}{b^w}$
- **Power Rule:** $(f(u))^w = f(uw)$. In other words, $(b^u)^w = b^{uw}$

While the properties listed in Theorem 6.5 are certainly believable based on similar properties of integer and rational exponents, the full proofs require Calculus. To each of these properties of

exponential functions corresponds an analogous property of logarithmic functions. We list these below in our next theorem.

Theorem 6.6. (Algebraic Properties of Logarithmic Functions) Let $g(x) = \log_b(x)$ be a logarithmic function ($b > 0$, $b \neq 1$) and let $u > 0$ and $w > 0$ be real numbers.

- **Product Rule:** $g(uw) = g(u) + g(w)$. In other words, $\log_b(uw) = \log_b(u) + \log_b(w)$
- **Quotient Rule:** $g\left(\frac{u}{w}\right) = g(u) - g(w)$. In other words, $\log_b\left(\frac{u}{w}\right) = \log_b(u) - \log_b(w)$
- **Power Rule:** $g(u^w) = wg(u)$. In other words, $\log_b(u^w) = w \log_b(u)$

There are a couple of different ways to understand why Theorem 6.6 is true. Consider the product rule: $\log_b(uw) = \log_b(u) + \log_b(w)$. Let $a = \log_b(uw)$, $c = \log_b(u)$, and $d = \log_b(w)$. Then, by definition, $b^a = uw$, $b^c = u$ and $b^d = w$. Hence, $b^a = uw = b^c b^d = b^{c+d}$, so that $b^a = b^{c+d}$. By the one-to-one property of b^x , we have $a = c + d$. In other words, $\log_b(uw) = \log_b(u) + \log_b(w)$. The remaining properties are proved similarly. From a purely functional approach, we can see the properties in Theorem 6.6 as an example of how inverse functions interchange the roles of inputs in outputs. For instance, the Product Rule for exponential functions given in Theorem 6.5, $f(u+w) = f(u)f(w)$, says that adding inputs results in multiplying outputs. Hence, whatever f^{-1} is, it must take the products of outputs from f and return them to the sum of their respective inputs. Since the outputs from f are the inputs to f^{-1} and vice-versa, we have that that f^{-1} must take products of its inputs to the sum of their respective outputs. This is precisely what the Product Rule for Logarithmic functions states in Theorem 6.6: $g(uw) = g(u) + g(w)$. The reader is encouraged to view the remaining properties listed in Theorem 6.6 similarly. The following examples help build familiarity with these properties. In our first example, we are asked to ‘expand’ the logarithms. This means that we read the properties in Theorem 6.6 from left to right and rewrite products inside the log as sums outside the log, quotients inside the log as differences outside the log, and powers inside the log as factors outside the log.¹

Example 6.2.1. Expand the following using the properties of logarithms and simplify. Assume when necessary that all quantities represent positive real numbers.

1. $\log_2\left(\frac{8}{x}\right)$

2. $\log_{0.1}(10x^2)$

3. $\ln\left(\frac{3}{ex}\right)^2$

4. $\log\sqrt[3]{\frac{100x^2}{yz^5}}$

5. $\log_{117}(x^2 - 4)$

Solution.

1. To expand $\log_2\left(\frac{8}{x}\right)$, we use the Quotient Rule identifying $u = 8$ and $w = x$ and simplify.

¹Interestingly enough, it is the exact *opposite* process (which we will practice later) that is most useful in Algebra, the utility of expanding logarithms becomes apparent in Calculus.

$$\begin{aligned}
 \log_2\left(\frac{8}{x}\right) &= \log_2(8) - \log_2(x) && \text{Quotient Rule} \\
 &= 3 - \log_2(x) && \text{Since } 2^3 = 8 \\
 &= -\log_2(x) + 3
 \end{aligned}$$

2. In the expression $\log_{0.1}(10x^2)$, we have a power (the x^2) and a product. In order to use the Product Rule, the *entire* quantity inside the logarithm must be raised to the same exponent. Since the exponent 2 applies only to the x , we first apply the Product Rule with $u = 10$ and $w = x^2$. Once we get the x^2 by itself inside the log, we may apply the Power Rule with $u = x$ and $w = 2$ and simplify.

$$\begin{aligned}
 \log_{0.1}(10x^2) &= \log_{0.1}(10) + \log_{0.1}(x^2) && \text{Product Rule} \\
 &= \log_{0.1}(10) + 2\log_{0.1}(x) && \text{Power Rule} \\
 &= -1 + 2\log_{0.1}(x) && \text{Since } (0.1)^{-1} = 10 \\
 &= 2\log_{0.1}(x) - 1
 \end{aligned}$$

3. We have a power, quotient and product occurring in $\ln\left(\frac{3}{ex}\right)^2$. Since the exponent 2 applies to the entire quantity inside the logarithm, we begin with the Power Rule with $u = \frac{3}{ex}$ and $w = 2$. Next, we see the Quotient Rule is applicable, with $u = 3$ and $w = ex$, so we replace $\ln\left(\frac{3}{ex}\right)$ with the quantity $\ln(3) - \ln(ex)$. Since $\ln\left(\frac{3}{ex}\right)$ is being multiplied by 2, the entire quantity $\ln(3) - \ln(ex)$ is multiplied by 2. Finally, we apply the Product Rule with $u = e$ and $w = x$, and replace $\ln(ex)$ with the quantity $\ln(e) + \ln(x)$, and simplify, keeping in mind that the natural log is log base e .

$$\begin{aligned}
 \ln\left(\frac{3}{ex}\right)^2 &= 2\ln\left(\frac{3}{ex}\right) && \text{Power Rule} \\
 &= 2[\ln(3) - \ln(ex)] && \text{Quotient Rule} \\
 &= 2\ln(3) - 2\ln(ex) \\
 &= 2\ln(3) - 2[\ln(e) + \ln(x)] && \text{Product Rule} \\
 &= 2\ln(3) - 2\ln(e) - 2\ln(x) \\
 &= 2\ln(3) - 2 - 2\ln(x) && \text{Since } e^1 = e \\
 &= -2\ln(x) + 2\ln(3) - 2
 \end{aligned}$$

4. In Theorem 6.6, there is no mention of how to deal with radicals. However, thinking back to Definition 5.5, we can rewrite the cube root as a $\frac{1}{3}$ exponent. We begin by using the Power

Rule², and we keep in mind that the common log is log base 10.

$$\begin{aligned}
 \log \sqrt[3]{\frac{100x^2}{yz^5}} &= \log \left(\frac{100x^2}{yz^5} \right)^{1/3} \\
 &= \frac{1}{3} \log \left(\frac{100x^2}{yz^5} \right) && \text{Power Rule} \\
 &= \frac{1}{3} [\log(100x^2) - \log(yz^5)] && \text{Quotient Rule} \\
 &= \frac{1}{3} \log(100x^2) - \frac{1}{3} \log(yz^5) \\
 &= \frac{1}{3} [\log(100) + \log(x^2)] - \frac{1}{3} [\log(y) + \log(z^5)] && \text{Product Rule} \\
 &= \frac{1}{3} \log(100) + \frac{1}{3} \log(x^2) - \frac{1}{3} \log(y) - \frac{1}{3} \log(z^5) \\
 &= \frac{1}{3} \log(100) + \frac{2}{3} \log(x) - \frac{1}{3} \log(y) - \frac{5}{3} \log(z) && \text{Power Rule} \\
 &= \frac{2}{3} + \frac{2}{3} \log(x) - \frac{1}{3} \log(y) - \frac{5}{3} \log(z) && \text{Since } 10^2 = 100 \\
 &= \frac{2}{3} \log(x) - \frac{1}{3} \log(y) - \frac{5}{3} \log(z) + \frac{2}{3}
 \end{aligned}$$

5. At first it seems as if we have no means of simplifying $\log_{117}(x^2 - 4)$, since none of the properties of logs addresses the issue of expanding a difference *inside* the logarithm. However, we may factor $x^2 - 4 = (x + 2)(x - 2)$ thereby introducing a product which gives us license to use the Product Rule.

$$\begin{aligned}
 \log_{117}(x^2 - 4) &= \log_{117}[(x + 2)(x - 2)] && \text{Factor} \\
 &= \log_{117}(x + 2) + \log_{117}(x - 2) && \text{Product Rule}
 \end{aligned}$$

□

A couple of remarks about Example 6.2.1 are in order. First, while not explicitly stated in the above example, a general rule of thumb to determine which log property to apply first to a complicated problem is ‘reverse order of operations.’ For example, if we were to substitute a number for x into the expression $\log_{0.1}(10x^2)$, we would first square the x , then multiply by 10. The last step is the multiplication, which tells us the first log property to apply is the Product Rule. In a multi-step problem, this rule can give the required guidance on which log property to apply at each step. The reader is encouraged to look through the solutions to Example 6.2.1 to see this rule in action. Second, while we were instructed to assume when necessary that all quantities represented positive real numbers, the authors would be committing a sin of omission if we failed to point out that, for instance, the functions $f(x) = \log_{117}(x^2 - 4)$ and $g(x) = \log_{117}(x + 2) + \log_{117}(x - 2)$ have different domains, and, hence, are different functions. We leave it to the reader to verify the domain of f is $(-\infty, -2) \cup (2, \infty)$ whereas the domain of g is $(2, \infty)$. In general, when using log properties to

²At this point in the text, the reader is encouraged to carefully read through each step and think of which quantity is playing the role of u and which is playing the role of w as we apply each property.

expand a logarithm, we may very well be restricting the domain as we do so. One last comment before we move to reassembling logs from their various bits and pieces. The authors are well aware of the propensity for some students to become overexcited and invent their own properties of logs like $\log_{117}(x^2 - 4) = \log_{117}(x^2) - \log_{117}(4)$, which simply isn't true, in general. The unwritten³ property of logarithms is that if it isn't written in a textbook, it probably isn't true.

Example 6.2.2. Use the properties of logarithms to write the following as a single logarithm.

1. $\log_3(x - 1) - \log_3(x + 1)$
2. $\log(x) + 2 \log(y) - \log(z)$
3. $4 \log_2(x) + 3$
4. $-\ln(x) - \frac{1}{2}$

Solution. Whereas in Example 6.2.1 we read the properties in Theorem 6.6 from left to right to expand logarithms, in this example we read them from right to left.

1. The difference of logarithms requires the Quotient Rule: $\log_3(x - 1) - \log_3(x + 1) = \log_3\left(\frac{x-1}{x+1}\right)$.
2. In the expression, $\log(x) + 2 \log(y) - \log(z)$, we have both a sum and difference of logarithms. However, before we use the product rule to combine $\log(x) + 2 \log(y)$, we note that we need to somehow deal with the coefficient 2 on $\log(y)$. This can be handled using the Power Rule. We can then apply the Product and Quotient Rules as we move from left to right. Putting it all together, we have

$$\begin{aligned} \log(x) + 2 \log(y) - \log(z) &= \log(x) + \log(y^2) - \log(z) && \text{Power Rule} \\ &= \log(xy^2) - \log(z) && \text{Product Rule} \\ &= \log\left(\frac{xy^2}{z}\right) && \text{Quotient Rule} \end{aligned}$$

3. We can certainly get started rewriting $4 \log_2(x) + 3$ by applying the Power Rule to $4 \log_2(x)$ to obtain $\log_2(x^4)$, but in order to use the Product Rule to handle the addition, we need to rewrite 3 as a logarithm base 2. From Theorem 6.3, we know $3 = \log_2(2^3)$, so we get

$$\begin{aligned} 4 \log_2(x) + 3 &= \log_2(x^4) + 3 && \text{Power Rule} \\ &= \log_2(x^4) + \log_2(2^3) && \text{Since } 3 = \log_2(2^3) \\ &= \log_2(x^4) + \log_2(8) \\ &= \log_2(8x^4) && \text{Product Rule} \end{aligned}$$

³The authors relish the irony involved in writing what follows.

4. To get started with $-\ln(x) - \frac{1}{2}$, we rewrite $-\ln(x)$ as $(-1)\ln(x)$. We can then use the Power Rule to obtain $(-1)\ln(x) = \ln(x^{-1})$. In order to use the Quotient Rule, we need to write $\frac{1}{2}$ as a natural logarithm. Theorem 6.3 gives us $\frac{1}{2} = \ln(e^{1/2}) = \ln(\sqrt{e})$. We have

$$\begin{aligned}
 -\ln(x) - \frac{1}{2} &= (-1)\ln(x) - \frac{1}{2} \\
 &= \ln(x^{-1}) - \frac{1}{2} && \text{Power Rule} \\
 &= \ln(x^{-1}) - \ln(e^{1/2}) && \text{Since } \frac{1}{2} = \ln(e^{1/2}) \\
 &= \ln(x^{-1}) - \ln(\sqrt{e}) \\
 &= \ln\left(\frac{x^{-1}}{\sqrt{e}}\right) && \text{Quotient Rule} \\
 &= \ln\left(\frac{1}{x\sqrt{e}}\right)
 \end{aligned}$$

□

As we would expect, the rule of thumb for re-assembling logarithms is the opposite of what it was for dismantling them. That is, if we are interested in rewriting an expression as a single logarithm, we apply log properties following the usual order of operations: deal with multiples of logs first with the Power Rule, then deal with addition and subtraction using the Product and Quotient Rules, respectively. Additionally, we find that using log properties in this fashion can increase the domain of the expression. For example, we leave it to the reader to verify the domain of $f(x) = \log_3(x-1) - \log_3(x+1)$ is $(1, \infty)$ but the domain of $g(x) = \log_3\left(\frac{x-1}{x+1}\right)$ is $(-\infty, -1) \cup (1, \infty)$. We will need to keep this in mind when we solve equations involving logarithms in Section 6.4 - it is precisely for this reason we will have to check for extraneous solutions.

The two logarithm buttons commonly found on calculators are the ‘LOG’ and ‘LN’ buttons which correspond to the common and natural logs, respectively. Suppose we wanted an approximation to $\log_2(7)$. The answer should be a little less than 3, (Can you explain why?) but how do we coerce the calculator into telling us a more accurate answer? We need the following theorem.

Theorem 6.7. (Change of Base Formulas) Let $a, b > 0$, $a, b \neq 1$.

- $a^x = b^{x \log_b(a)}$ for all real numbers x .
- $\log_a(x) = \frac{\log_b(x)}{\log_b(a)}$ for all real numbers $x > 0$.

The proofs of the Change of Base formulas are a result of the other properties studied in this section. If we start with $b^{x \log_b(a)}$ and use the Power Rule in the exponent to rewrite $x \log_b(a)$ as $\log_b(a^x)$ and then apply one of the Inverse Properties in Theorem 6.3, we get

$$b^{x \log_b(a)} = b^{\log_b(a^x)} = a^x,$$

as required. To verify the logarithmic form of the property, we also use the Power Rule and an Inverse Property. We note that

$$\log_a(x) \cdot \log_b(a) = \log_b\left(a^{\log_a(x)}\right) = \log_b(x),$$

and we get the result by dividing through by $\log_b(a)$. Of course, the authors can't help but point out the inverse relationship between these two change of base formulas. To change the base of an exponential expression, we *multiply* the *input* by the factor $\log_b(a)$. To change the base of a logarithmic expression, we *divide* the *output* by the factor $\log_b(a)$. While, in the grand scheme of things, both change of base formulas are really saying the same thing, the logarithmic form is the one usually encountered in Algebra while the exponential form isn't usually introduced until Calculus.⁴ What Theorem 6.7 really tells us is that all exponential and logarithmic functions are just scalings of one another. Not only does this explain why their graphs have similar shapes, but it also tells us that we could do all of mathematics with a single base - be it 10, e , 42, or 117. Your Calculus teacher will have more to say about this when the time comes.

Example 6.2.3. Use an appropriate change of base formula to convert the following expressions to ones with the indicated base. Verify your answers using a calculator, as appropriate.

- | | |
|----------------------------|------------------------|
| 1. 3^2 to base 10 | 2. 2^x to base e |
| 3. $\log_4(5)$ to base e | 4. $\ln(x)$ to base 10 |

Solution.

1. We apply the Change of Base formula with $a = 3$ and $b = 10$ to obtain $3^2 = 10^{2\log(3)}$. Typing the latter in the calculator produces an answer of 9 as required.
2. Here, $a = 2$ and $b = e$ so we have $2^x = e^{x\ln(2)}$. To verify this on our calculator, we can graph $f(x) = 2^x$ and $g(x) = e^{x\ln(2)}$. Their graphs are indistinguishable which provides evidence that they are the same function.

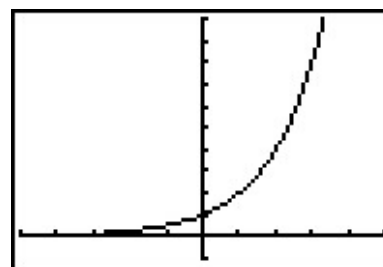
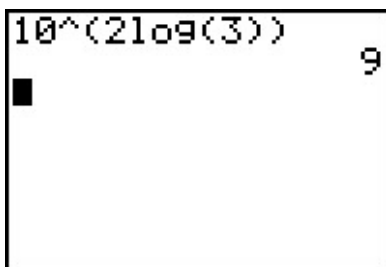

$$y = f(x) = 2^x \text{ and } y = g(x) = e^{x\ln(2)}$$

⁴The authors feel so strongly about showing students that every property of logarithms comes from and corresponds to a property of exponents that we have broken tradition with the vast majority of other authors in this field. This isn't the first time this happened, and it certainly won't be the last.

3. Applying the change of base with $a = 4$ and $b = e$ leads us to write $\log_4(5) = \frac{\ln(5)}{\ln(4)}$. Evaluating this in the calculator gives $\frac{\ln(5)}{\ln(4)} \approx 1.16$. How do we check this really is the value of $\log_4(5)$? By definition, $\log_4(5)$ is the exponent we put on 4 to get 5. The calculator confirms this.⁵
4. We write $\ln(x) = \log_e(x) = \frac{\log(x)}{\log(e)}$. We graph both $f(x) = \ln(x)$ and $g(x) = \frac{\log(x)}{\log(e)}$ and find both graphs appear to be identical.

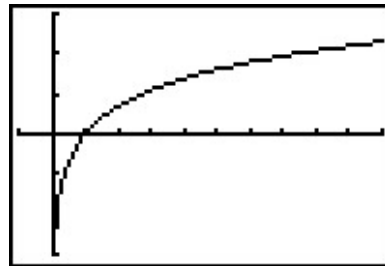

$$y = f(x) = \ln(x) \text{ and } y = g(x) = \frac{\log(x)}{\log(e)} \quad \square$$

⁵Which means if it is lying to us about the first answer it gave us, at least it is being consistent.

6.2.1 EXERCISES

In Exercises 1 - 15, expand the given logarithm and simplify. Assume when necessary that all quantities represent positive real numbers.

1. $\ln(x^3y^2)$

2. $\log_2\left(\frac{128}{x^2+4}\right)$

3. $\log_5\left(\frac{z}{25}\right)^3$

4. $\log(1.23 \times 10^{37})$

5. $\ln\left(\frac{\sqrt{z}}{xy}\right)$

6. $\log_5(x^2 - 25)$

7. $\log_{\sqrt{2}}(4x^3)$

8. $\log_{\frac{1}{3}}(9x(y^3 - 8))$

9. $\log(1000x^3y^5)$

10. $\log_3\left(\frac{x^2}{81y^4}\right)$

11. $\ln\left(\sqrt[4]{\frac{xy}{ez}}\right)$

12. $\log_6\left(\frac{216}{x^3y}\right)^4$

13. $\log\left(\frac{100x\sqrt{y}}{\sqrt[3]{10}}\right)$

14. $\log_{\frac{1}{2}}\left(\frac{4\sqrt[3]{x^2}}{y\sqrt{z}}\right)$

15. $\ln\left(\frac{\sqrt[3]{x}}{10\sqrt{yz}}\right)$

In Exercises 16 - 29, use the properties of logarithms to write the expression as a single logarithm.

16. $4\ln(x) + 2\ln(y)$

17. $\log_2(x) + \log_2(y) - \log_2(z)$

18. $\log_3(x) - 2\log_3(y)$

19. $\frac{1}{2}\log_3(x) - 2\log_3(y) - \log_3(z)$

20. $2\ln(x) - 3\ln(y) - 4\ln(z)$

21. $\log(x) - \frac{1}{3}\log(z) + \frac{1}{2}\log(y)$

22. $-\frac{1}{3}\ln(x) - \frac{1}{3}\ln(y) + \frac{1}{3}\ln(z)$

23. $\log_5(x) - 3$

24. $3 - \log(x)$

25. $\log_7(x) + \log_7(x - 3) - 2$

26. $\ln(x) + \frac{1}{2}$

27. $\log_2(x) + \log_4(x)$

28. $\log_2(x) + \log_4(x - 1)$

29. $\log_2(x) + \log_{\frac{1}{2}}(x - 1)$

In Exercises 30 - 33, use the appropriate change of base formula to convert the given expression to an expression with the indicated base.

30. 7^{x-1} to base e

31. $\log_3(x+2)$ to base 10

32. $\left(\frac{2}{3}\right)^x$ to base e

33. $\log(x^2+1)$ to base e

In Exercises 34 - 39, use the appropriate change of base formula to approximate the logarithm.

34. $\log_3(12)$

35. $\log_5(80)$

36. $\log_6(72)$

37. $\log_4\left(\frac{1}{10}\right)$

38. $\log_{\frac{3}{5}}(1000)$

39. $\log_{\frac{2}{3}}(50)$

40. Compare and contrast the graphs of $y = \ln(x^2)$ and $y = 2\ln(x)$.

41. Prove the Quotient Rule and Power Rule for Logarithms.

42. Give numerical examples to show that, in general,

(a) $\log_b(x+y) \neq \log_b(x) + \log_b(y)$

(b) $\log_b(x-y) \neq \log_b(x) - \log_b(y)$

(c) $\log_b\left(\frac{x}{y}\right) \neq \frac{\log_b(x)}{\log_b(y)}$

43. The Henderson-Hasselbalch Equation: Suppose HA represents a weak acid. Then we have a reversible chemical reaction



The acid disassociation constant, K_a , is given by

$$K_a = \frac{[H^+][A^-]}{[HA]} = [H^+] \frac{[A^-]}{[HA]},$$

where the square brackets denote the concentrations just as they did in Exercise 77 in Section 6.1. The symbol pK_a is defined similarly to pH in that $pK_a = -\log(K_a)$. Using the definition of pH from Exercise 77 and the properties of logarithms, derive the Henderson-Hasselbalch Equation which states

$$\text{pH} = pK_a + \log \frac{[A^-]}{[HA]}$$

44. Research the history of logarithms including the origin of the word 'logarithm' itself. Why is the abbreviation of natural log 'ln' and not 'nl'?

45. There is a scene in the movie 'Apollo 13' in which several people at Mission Control use slide rules to verify a computation. Was that scene accurate? Look for other pop culture references to logarithms and slide rules.

6.2.2 ANSWERS

1. $3 \ln(x) + 2 \ln(y)$
2. $7 - \log_2(x^2 + 4)$
3. $3 \log_5(z) - 6$
4. $\log(1.23) + 37$
5. $\frac{1}{2} \ln(z) - \ln(x) - \ln(y)$
6. $\log_5(x - 5) + \log_5(x + 5)$
7. $3 \log_{\sqrt{2}}(x) + 4$
8. $-2 + \log_{\frac{1}{3}}(x) + \log_{\frac{1}{3}}(y - 2) + \log_{\frac{1}{3}}(y^2 + 2y + 4)$
9. $3 + 3 \log(x) + 5 \log(y)$
10. $2 \log_3(x) - 4 - 4 \log_3(y)$
11. $\frac{1}{4} \ln(x) + \frac{1}{4} \ln(y) - \frac{1}{4} - \frac{1}{4} \ln(z)$
12. $12 - 12 \log_6(x) - 4 \log_6(y)$
13. $\frac{5}{3} + \log(x) + \frac{1}{2} \log(y)$
14. $-2 + \frac{2}{3} \log_{\frac{1}{2}}(x) - \log_{\frac{1}{2}}(y) - \frac{1}{2} \log_{\frac{1}{2}}(z)$
15. $\frac{1}{3} \ln(x) - \ln(10) - \frac{1}{2} \ln(y) - \frac{1}{2} \ln(z)$
16. $\ln(x^4 y^2)$
17. $\log_2\left(\frac{xy}{z}\right)$
18. $\log_3\left(\frac{x}{y^2}\right)$
19. $\log_3\left(\frac{\sqrt{x}}{y^2 z}\right)$
20. $\ln\left(\frac{x^2}{y^3 z^4}\right)$
21. $\log\left(\frac{x\sqrt{y}}{\sqrt[3]{z}}\right)$
22. $\ln\left(\sqrt[3]{\frac{z}{xy}}\right)$
23. $\log_5\left(\frac{x}{125}\right)$
24. $\log\left(\frac{1000}{x}\right)$
25. $\log_7\left(\frac{x(x-3)}{49}\right)$
26. $\ln(x\sqrt{e})$
27. $\log_2(x^{3/2})$
28. $\log_2(x\sqrt{x-1})$
29. $\log_2\left(\frac{x}{x-1}\right)$
30. $7^{x-1} = e^{(x-1)\ln(7)}$
31. $\log_3(x+2) = \frac{\log(x+2)}{\log(3)}$
32. $\left(\frac{2}{3}\right)^x = e^{x \ln(\frac{2}{3})}$
33. $\log(x^2 + 1) = \frac{\ln(x^2+1)}{\ln(10)}$
34. $\log_3(12) \approx 2.26186$
35. $\log_5(80) \approx 2.72271$
36. $\log_6(72) \approx 2.38685$
37. $\log_4\left(\frac{1}{10}\right) \approx -1.66096$
38. $\log_{\frac{3}{5}}(1000) \approx -13.52273$
39. $\log_{\frac{2}{3}}(50) \approx -9.64824$

6.3 EXPONENTIAL EQUATIONS AND INEQUALITIES

In this section we will develop techniques for solving equations involving exponential functions. Suppose, for instance, we wanted to solve the equation $2^x = 128$. After a moment's calculation, we find $128 = 2^7$, so we have $2^x = 2^7$. The one-to-one property of exponential functions, detailed in Theorem 6.4, tells us that $2^x = 2^7$ if and only if $x = 7$. This means that not only is $x = 7$ a solution to $2^x = 2^7$, it is the *only* solution. Now suppose we change the problem ever so slightly to $2^x = 129$. We could use one of the inverse properties of exponentials and logarithms listed in Theorem 6.3 to write $129 = 2^{\log_2(129)}$. We'd then have $2^x = 2^{\log_2(129)}$, which means our solution is $x = \log_2(129)$. This makes sense because, after all, the definition of $\log_2(129)$ is 'the exponent we put on 2 to get 129.' Indeed we could have obtained this solution directly by rewriting the equation $2^x = 129$ in its logarithmic form $\log_2(129) = x$. Either way, in order to get a reasonable decimal approximation to this number, we'd use the change of base formula, Theorem 6.7, to give us something more calculator friendly,¹ say $\log_2(129) = \frac{\ln(129)}{\ln(2)}$. Another way to arrive at this answer is as follows

$$\begin{aligned} 2^x &= 129 \\ \ln(2^x) &= \ln(129) && \text{Take the natural log of both sides.} \\ x \ln(2) &= \ln(129) && \text{Power Rule} \\ x &= \frac{\ln(129)}{\ln(2)} \end{aligned}$$

'Taking the natural log' of both sides is akin to squaring both sides: since $f(x) = \ln(x)$ is a *function*, as long as two quantities are equal, their natural logs are equal.² Also note that we treat $\ln(2)$ as any other non-zero real number and divide it through³ to isolate the variable x . We summarize below the two common ways to solve exponential equations, motivated by our examples.

Steps for Solving an Equation involving Exponential Functions

1. Isolate the exponential function.
2. (a) If convenient, express both sides with a common base and equate the exponents.
(b) Otherwise, take the natural log of both sides of the equation and use the Power Rule.

Example 6.3.1. Solve the following equations. Check your answer graphically using a calculator.

1. $2^{3x} = 16^{1-x}$
2. $2000 = 1000 \cdot 3^{-0.1t}$
3. $9 \cdot 3^x = 7^{2x}$
4. $75 = \frac{100}{1+3e^{-2t}}$
5. $25^x = 5^x + 6$
6. $\frac{e^x - e^{-x}}{2} = 5$

Solution.

¹You can use natural logs or common logs. We choose natural logs. (In Calculus, you'll learn these are the most 'mathy' of the logarithms.)

²This is also the 'if' part of the statement $\log_b(u) = \log_b(w)$ if and only if $u = w$ in Theorem 6.4.

³Please resist the temptation to divide both sides by 'ln' instead of $\ln(2)$. Just like it wouldn't make sense to divide both sides by the square root symbol ' $\sqrt{\quad}$ ' when solving $x\sqrt{2} = 5$, it makes no sense to divide by 'ln'.

- Since 16 is a power of 2, we can rewrite $2^{3x} = 16^{1-x}$ as $2^{3x} = (2^4)^{1-x}$. Using properties of exponents, we get $2^{3x} = 2^{4(1-x)}$. Using the one-to-one property of exponential functions, we get $3x = 4(1-x)$ which gives $x = \frac{4}{7}$. To check graphically, we set $f(x) = 2^{3x}$ and $g(x) = 16^{1-x}$ and see that they intersect at $x = \frac{4}{7} \approx 0.5714$.
- We begin solving $2000 = 1000 \cdot 3^{-0.1t}$ by dividing both sides by 1000 to isolate the exponential which yields $3^{-0.1t} = 2$. Since it is inconvenient to write 2 as a power of 3, we use the natural log to get $\ln(3^{-0.1t}) = \ln(2)$. Using the Power Rule, we get $-0.1t \ln(3) = \ln(2)$, so we divide both sides by $-0.1 \ln(3)$ to get $t = -\frac{\ln(2)}{0.1 \ln(3)} = -\frac{10 \ln(2)}{\ln(3)}$. On the calculator, we graph $f(x) = 2000$ and $g(x) = 1000 \cdot 3^{-0.1x}$ and find that they intersect at $x = -\frac{10 \ln(2)}{\ln(3)} \approx -6.3093$.

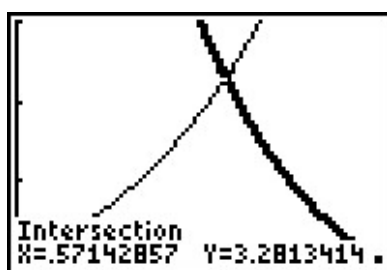

$$y = f(x) = 2^{3x} \text{ and}$$

$$y = g(x) = 16^{1-x}$$

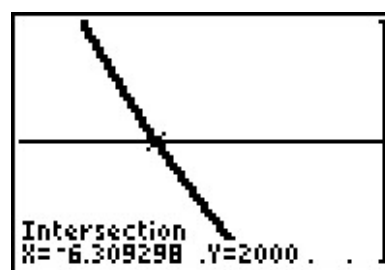

$$y = f(x) = 2000 \text{ and}$$

$$y = g(x) = 1000 \cdot 3^{-0.1x}$$

- We first note that we can rewrite the equation $9 \cdot 3^x = 7^{2x}$ as $3^2 \cdot 3^x = 7^{2x}$ to obtain $3^{x+2} = 7^{2x}$. Since it is not convenient to express both sides as a power of 3 (or 7 for that matter) we use the natural log: $\ln(3^{x+2}) = \ln(7^{2x})$. The power rule gives $(x+2) \ln(3) = 2x \ln(7)$. Even though this equation appears very complicated, keep in mind that $\ln(3)$ and $\ln(7)$ are just constants. The equation $(x+2) \ln(3) = 2x \ln(7)$ is actually a linear equation and as such we gather all of the terms with x on one side, and the constants on the other. We then divide both sides by the coefficient of x , which we obtain by factoring.

$$\begin{aligned} (x+2) \ln(3) &= 2x \ln(7) \\ x \ln(3) + 2 \ln(3) &= 2x \ln(7) \\ 2 \ln(3) &= 2x \ln(7) - x \ln(3) \\ 2 \ln(3) &= x(2 \ln(7) - \ln(3)) \quad \text{Factor.} \\ x &= \frac{2 \ln(3)}{2 \ln(7) - \ln(3)} \end{aligned}$$

Graphing $f(x) = 9 \cdot 3^x$ and $g(x) = 7^{2x}$ on the calculator, we see that these two graphs intersect at $x = \frac{2 \ln(3)}{2 \ln(7) - \ln(3)} \approx 0.7866$.

- Our objective in solving $75 = \frac{100}{1+3e^{-2t}}$ is to first isolate the exponential. To that end, we clear denominators and get $75(1+3e^{-2t}) = 100$. From this we get $75 + 225e^{-2t} = 100$, which leads to $225e^{-2t} = 25$, and finally, $e^{-2t} = \frac{1}{9}$. Taking the natural log of both sides

gives $\ln(e^{-2t}) = \ln(\frac{1}{9})$. Since natural log is log base e , $\ln(e^{-2t}) = -2t$. We can also use the Power Rule to write $\ln(\frac{1}{9}) = -\ln(9)$. Putting these two steps together, we simplify $\ln(e^{-2t}) = \ln(\frac{1}{9})$ to $-2t = -\ln(9)$. We arrive at our solution, $t = \frac{\ln(9)}{2}$ which simplifies to $t = \ln(3)$. (Can you explain why?) The calculator confirms the graphs of $f(x) = 75$ and $g(x) = \frac{100}{1+3e^{-2x}}$ intersect at $x = \ln(3) \approx 1.099$.

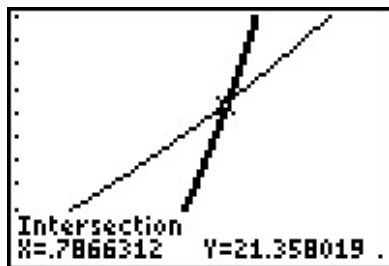

$$y = f(x) = 9 \cdot 3^x \text{ and}$$

$$y = g(x) = 7^{2x}$$

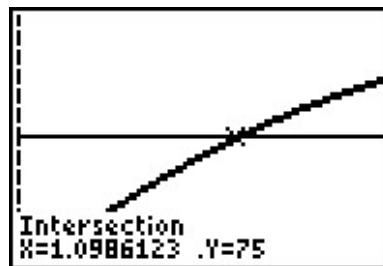

$$y = f(x) = 75 \text{ and}$$

$$y = g(x) = \frac{100}{1+3e^{-2x}}$$

5. We start solving $25^x = 5^x + 6$ by rewriting $25 = 5^2$ so that we have $(5^2)^x = 5^x + 6$, or $5^{2x} = 5^x + 6$. Even though we have a common base, having two terms on the right hand side of the equation foils our plan of equating exponents or taking logs. If we stare at this long enough, we notice that we have three terms with the exponent on one term exactly twice that of another. To our surprise and delight, we have a 'quadratic in disguise'. Letting $u = 5^x$, we have $u^2 = (5^x)^2 = 5^{2x}$ so the equation $5^{2x} = 5^x + 6$ becomes $u^2 = u + 6$. Solving this as $u^2 - u - 6 = 0$ gives $u = -2$ or $u = 3$. Since $u = 5^x$, we have $5^x = -2$ or $5^x = 3$. Since $5^x = -2$ has no real solution, (Why not?) we focus on $5^x = 3$. Since it isn't convenient to express 3 as a power of 5, we take natural logs and get $\ln(5^x) = \ln(3)$ so that $x \ln(5) = \ln(3)$ or $x = \frac{\ln(3)}{\ln(5)}$. On the calculator, we see the graphs of $f(x) = 25^x$ and $g(x) = 5^x + 6$ intersect at $x = \frac{\ln(3)}{\ln(5)} \approx 0.6826$.
6. At first, it's unclear how to proceed with $\frac{e^x - e^{-x}}{2} = 5$, besides clearing the denominator to obtain $e^x - e^{-x} = 10$. Of course, if we rewrite $e^{-x} = \frac{1}{e^x}$, we see we have another denominator lurking in the problem: $e^x - \frac{1}{e^x} = 10$. Clearing this denominator gives us $e^{2x} - 1 = 10e^x$, and once again, we have an equation with three terms where the exponent on one term is exactly twice that of another - a 'quadratic in disguise.' If we let $u = e^x$, then $u^2 = e^{2x}$ so the equation $e^{2x} - 1 = 10e^x$ can be viewed as $u^2 - 1 = 10u$. Solving $u^2 - 10u - 1 = 0$, we obtain by the quadratic formula $u = 5 \pm \sqrt{26}$. From this, we have $e^x = 5 \pm \sqrt{26}$. Since $5 - \sqrt{26} < 0$, we get no real solution to $e^x = 5 - \sqrt{26}$, but for $e^x = 5 + \sqrt{26}$, we take natural logs to obtain $x = \ln(5 + \sqrt{26})$. If we graph $f(x) = \frac{e^x - e^{-x}}{2}$ and $g(x) = 5$, we see that the graphs intersect at $x = \ln(5 + \sqrt{26}) \approx 2.312$

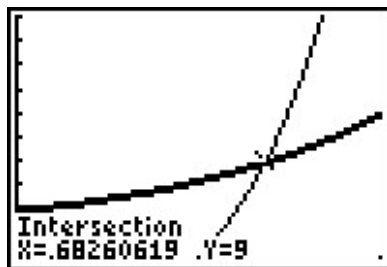

$$y = f(x) = 25^x \text{ and}$$

$$y = g(x) = 5^x + 6$$

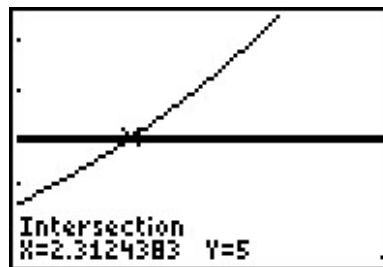

$$y = f(x) = \frac{e^x - e^{-x}}{2} \text{ and}$$

$$y = g(x) = 5$$

□

The authors would be remiss not to mention that Example 6.3.1 still holds great educational value. Much can be learned about logarithms and exponentials by verifying the solutions obtained in Example 6.3.1 analytically. For example, to verify our solution to $2000 = 1000 \cdot 3^{-0.1t}$, we substitute $t = -\frac{10 \ln(2)}{\ln(3)}$ and obtain

$$\begin{aligned} 2000 &\stackrel{?}{=} 1000 \cdot 3^{-0.1 \left(-\frac{10 \ln(2)}{\ln(3)} \right)} \\ 2000 &\stackrel{?}{=} 1000 \cdot 3^{\frac{\ln(2)}{\ln(3)}} \\ 2000 &\stackrel{?}{=} 1000 \cdot 3^{\log_3(2)} && \text{Change of Base} \\ 2000 &\stackrel{?}{=} 1000 \cdot 2 && \text{Inverse Property} \\ 2000 &\stackrel{\checkmark}{=} 2000 \end{aligned}$$

The other solutions can be verified by using a combination of log and inverse properties. Some fall out quite quickly, while others are more involved. We leave them to the reader.

Since exponential functions are continuous on their domains, the Intermediate Value Theorem 3.1 applies. As with the algebraic functions in Section 5.3, this allows us to solve inequalities using sign diagrams as demonstrated below.

Example 6.3.2. Solve the following inequalities. Check your answer graphically using a calculator.

1. $2^{x^2-3x} - 16 \geq 0$

2. $\frac{e^x}{e^x - 4} \leq 3$

3. $xe^{2x} < 4x$

Solution.

1. Since we already have 0 on one side of the inequality, we set $r(x) = 2^{x^2-3x} - 16$. The domain of r is all real numbers, so in order to construct our sign diagram, we need to find the zeros of r . Setting $r(x) = 0$ gives $2^{x^2-3x} - 16 = 0$ or $2^{x^2-3x} = 16$. Since $16 = 2^4$ we have $2^{x^2-3x} = 2^4$, so by the one-to-one property of exponential functions, $x^2 - 3x = 4$. Solving $x^2 - 3x - 4 = 0$ gives $x = 4$ and $x = -1$. From the sign diagram, we see $r(x) \geq 0$ on $(-\infty, -1] \cup [4, \infty)$, which corresponds to where the graph of $y = r(x) = 2^{x^2-3x} - 16$, is on or above the x -axis.

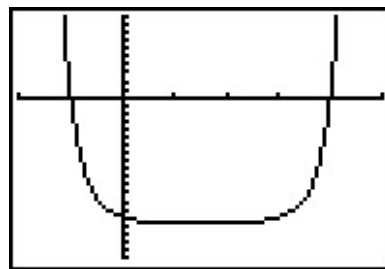
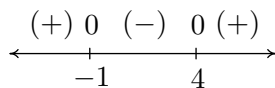

$$y = r(x) = 2^{x^2-3x} - 16$$

2. The first step we need to take to solve $\frac{e^x}{e^x-4} \leq 3$ is to get 0 on one side of the inequality. To that end, we subtract 3 from both sides and get a common denominator

$$\begin{aligned} \frac{e^x}{e^x-4} &\leq 3 \\ \frac{e^x}{e^x-4} - 3 &\leq 0 \\ \frac{e^x}{e^x-4} - \frac{3(e^x-4)}{e^x-4} &\leq 0 \quad \text{Common denominators.} \\ \frac{12-2e^x}{e^x-4} &\leq 0 \end{aligned}$$

We set $r(x) = \frac{12-2e^x}{e^x-4}$ and we note that r is undefined when its denominator $e^x - 4 = 0$, or when $e^x = 4$. Solving this gives $x = \ln(4)$, so the domain of r is $(-\infty, \ln(4)) \cup (\ln(4), \infty)$. To find the zeros of r , we solve $r(x) = 0$ and obtain $12 - 2e^x = 0$. Solving for e^x , we find $e^x = 6$, or $x = \ln(6)$. When we build our sign diagram, finding test values may be a little tricky since we need to check values around $\ln(4)$ and $\ln(6)$. Recall that the function $\ln(x)$ is increasing⁴ which means $\ln(3) < \ln(4) < \ln(5) < \ln(6) < \ln(7)$. While the prospect of determining the sign of $r(\ln(3))$ may be very unsettling, remember that $e^{\ln(3)} = 3$, so

$$r(\ln(3)) = \frac{12 - 2e^{\ln(3)}}{e^{\ln(3)} - 4} = \frac{12 - 2(3)}{3 - 4} = -6$$

We determine the signs of $r(\ln(5))$ and $r(\ln(7))$ similarly.⁵ From the sign diagram, we find our answer to be $(-\infty, \ln(4)) \cup [\ln(6), \infty)$. Using the calculator, we see the graph of $f(x) = \frac{e^x}{e^x-4}$ is below the graph of $g(x) = 3$ on $(-\infty, \ln(4)) \cup (\ln(6), \infty)$, and they intersect at $x = \ln(6) \approx 1.792$.

⁴This is because the base of $\ln(x)$ is $e > 1$. If the base b were in the interval $0 < b < 1$, then $\log_b(x)$ would decrease.

⁵We could, of course, use the calculator, but what fun would that be?

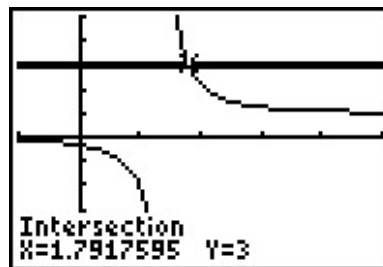
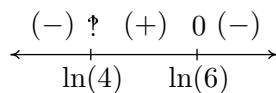

$$y = f(x) = \frac{e^x}{e^x - 4}$$

$$y = g(x) = 3$$

3. As before, we start solving $xe^{2x} < 4x$ by getting 0 on one side of the inequality, $xe^{2x} - 4x < 0$. We set $r(x) = xe^{2x} - 4x$ and since there are no denominators, even-indexed radicals, or logs, the domain of r is all real numbers. Setting $r(x) = 0$ produces $xe^{2x} - 4x = 0$. We factor to get $x(e^{2x} - 4) = 0$ which gives $x = 0$ or $e^{2x} - 4 = 0$. To solve the latter, we isolate the exponential and take logs to get $2x = \ln(4)$, or $x = \frac{\ln(4)}{2} = \ln(2)$. (Can you explain the last equality using properties of logs?) As in the previous example, we need to be careful about choosing test values. Since $\ln(1) = 0$, we choose $\ln(\frac{1}{2})$, $\ln(\frac{3}{2})$ and $\ln(3)$. Evaluating,⁶ we get

$$\begin{aligned} r\left(\ln\left(\frac{1}{2}\right)\right) &= \ln\left(\frac{1}{2}\right) e^{2\ln\left(\frac{1}{2}\right)} - 4\ln\left(\frac{1}{2}\right) \\ &= \ln\left(\frac{1}{2}\right) e^{\ln\left(\frac{1}{2}\right)^2} - 4\ln\left(\frac{1}{2}\right) && \text{Power Rule} \\ &= \ln\left(\frac{1}{2}\right) e^{\ln\left(\frac{1}{4}\right)} - 4\ln\left(\frac{1}{2}\right) \\ &= \frac{1}{4}\ln\left(\frac{1}{2}\right) - 4\ln\left(\frac{1}{2}\right) = -\frac{15}{4}\ln\left(\frac{1}{2}\right) \end{aligned}$$

Since $\frac{1}{2} < 1$, $\ln(\frac{1}{2}) < 0$ and we get $r(\ln(\frac{1}{2}))$ is (+), so $r(x) < 0$ on $(0, \ln(2))$. The calculator confirms that the graph of $f(x) = xe^{2x}$ is below the graph of $g(x) = 4x$ on these intervals.⁷

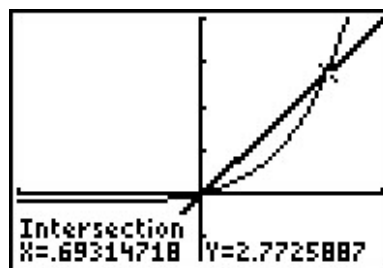
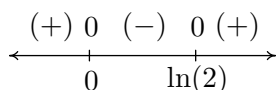

$$y = f(x) = xe^{2x} \text{ and } y = g(x) = 4x$$

□

⁶A calculator can be used at this point. As usual, we proceed without apologies, with the analytical method.

⁷Note: $\ln(2) \approx 0.693$.

Example 6.3.3. Recall from Example 6.1.2 that the temperature of coffee T (in degrees Fahrenheit) t minutes after it is served can be modeled by $T(t) = 70 + 90e^{-0.1t}$. When will the coffee be warmer than 100°F ?

Solution. We need to find when $T(t) > 100$, or in other words, we need to solve the inequality $70 + 90e^{-0.1t} > 100$. Getting 0 on one side of the inequality, we have $90e^{-0.1t} - 30 > 0$, and we set $r(t) = 90e^{-0.1t} - 30$. The domain of r is artificially restricted due to the context of the problem to $[0, \infty)$, so we proceed to find the zeros of r . Solving $90e^{-0.1t} - 30 = 0$ results in $e^{-0.1t} = \frac{1}{3}$ so that $t = -10 \ln\left(\frac{1}{3}\right)$ which, after a quick application of the Power Rule leaves us with $t = 10 \ln(3)$. If we wish to avoid using the calculator to choose test values, we note that since $1 < 3$, $0 = \ln(1) < \ln(3)$ so that $10 \ln(3) > 0$. So we choose $t = 0$ as a test value in $[0, 10 \ln(3))$. Since $3 < 4$, $10 \ln(3) < 10 \ln(4)$, so the latter is our choice of a test value for the interval $(10 \ln(3), \infty)$. Our sign diagram is below, and next to it is our graph of $y = T(t)$ from Example 6.1.2 with the horizontal line $y = 100$.

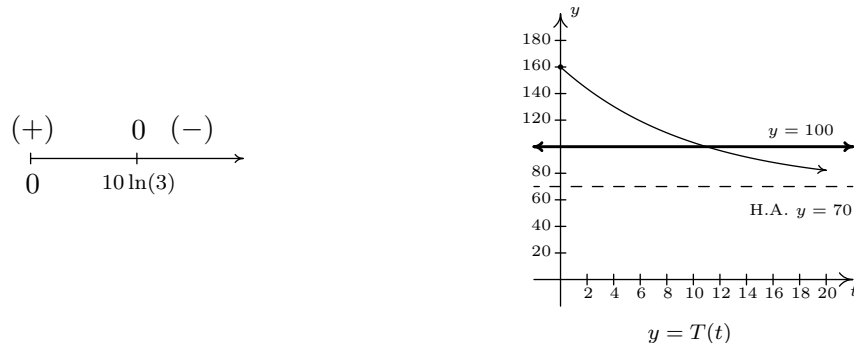

In order to interpret what this means in the context of the real world, we need a reasonable approximation of the number $10 \ln(3) \approx 10.986$. This means it takes approximately 11 minutes for the coffee to cool to 100°F . Until then, the coffee is warmer than that.⁸ \square

We close this section by finding the inverse of a function which is a composition of a rational function with an exponential function.

Example 6.3.4. The function $f(x) = \frac{5e^x}{e^x + 1}$ is one-to-one. Find a formula for $f^{-1}(x)$ and check your answer graphically using your calculator.

Solution. We start by writing $y = f(x)$, and interchange the roles of x and y . To solve for y , we first clear denominators and then isolate the exponential function.

⁸Critics may point out that since we needed to use the calculator to interpret our answer anyway, why not use it earlier to simplify the computations? It is a fair question which we answer unfairly: it's our book.

$$\begin{aligned}
 y &= \frac{5e^x}{e^x + 1} \\
 x &= \frac{5e^y}{e^y + 1} && \text{Switch } x \text{ and } y \\
 x(e^y + 1) &= 5e^y \\
 xe^y + x &= 5e^y \\
 x &= 5e^y - xe^y \\
 x &= e^y(5 - x) \\
 e^y &= \frac{x}{5 - x} \\
 \ln(e^y) &= \ln\left(\frac{x}{5 - x}\right) \\
 y &= \ln\left(\frac{x}{5 - x}\right)
 \end{aligned}$$

We claim $f^{-1}(x) = \ln\left(\frac{x}{5-x}\right)$. To verify this analytically, we would need to verify the compositions $(f^{-1} \circ f)(x) = x$ for all x in the domain of f and that $(f \circ f^{-1})(x) = x$ for all x in the domain of f^{-1} . We leave this to the reader. To verify our solution graphically, we graph $y = f(x) = \frac{5e^x}{e^x + 1}$ and $y = g(x) = \ln\left(\frac{x}{5-x}\right)$ on the same set of axes and observe the symmetry about the line $y = x$. Note the domain of f is the range of g and vice-versa.

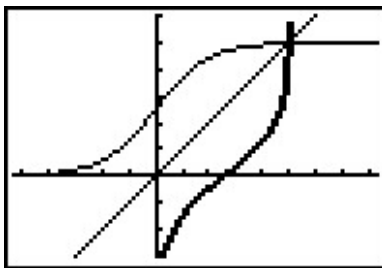

$$y = f(x) = \frac{5e^x}{e^x + 1} \text{ and } y = g(x) = \ln\left(\frac{x}{5-x}\right)$$

□

6.3.1 EXERCISES

In Exercises 1 - 33, solve the equation analytically.

- | | | |
|---|---|--|
| 1. $2^{4x} = 8$ | 2. $3^{(x-1)} = 27$ | 3. $5^{2x-1} = 125$ |
| 4. $4^{2x} = \frac{1}{2}$ | 5. $8^x = \frac{1}{128}$ | 6. $2^{(x^3-x)} = 1$ |
| 7. $3^{7x} = 81^{4-2x}$ | 8. $9 \cdot 3^{7x} = \left(\frac{1}{9}\right)^{2x}$ | 9. $3^{2x} = 5$ |
| 10. $5^{-x} = 2$ | 11. $5^x = -2$ | 12. $3^{(x-1)} = 29$ |
| 13. $(1.005)^{12x} = 3$ | 14. $e^{-5730k} = \frac{1}{2}$ | 15. $2000e^{0.1t} = 4000$ |
| 16. $500(1 - e^{2x}) = 250$ | 17. $70 + 90e^{-0.1t} = 75$ | 18. $30 - 6e^{-0.1x} = 20$ |
| 19. $\frac{100e^x}{e^x + 2} = 50$ | 20. $\frac{5000}{1 + 2e^{-3t}} = 2500$ | 21. $\frac{150}{1 + 29e^{-0.8t}} = 75$ |
| 22. $25\left(\frac{4}{5}\right)^x = 10$ | 23. $e^{2x} = 2e^x$ | 24. $7e^{2x} = 28e^{-6x}$ |
| 25. $3^{(x-1)} = 2^x$ | 26. $3^{(x-1)} = \left(\frac{1}{2}\right)^{(x+5)}$ | 27. $7^{3+7x} = 3^{4-2x}$ |
| 28. $e^{2x} - 3e^x - 10 = 0$ | 29. $e^{2x} = e^x + 6$ | 30. $4^x + 2^x = 12$ |
| 31. $e^x - 3e^{-x} = 2$ | 32. $e^x + 15e^{-x} = 8$ | 33. $3^x + 25 \cdot 3^{-x} = 10$ |

In Exercises 34 - 39, solve the inequality analytically.

- | | |
|--|--|
| 34. $e^x > 53$ | 35. $1000(1.005)^{12t} \geq 3000$ |
| 36. $2^{(x^3-x)} < 1$ | 37. $25\left(\frac{4}{5}\right)^x \geq 10$ |
| 38. $\frac{150}{1 + 29e^{-0.8t}} \leq 130$ | 39. $70 + 90e^{-0.1t} \leq 75$ |

In Exercises 40 - 45, use your calculator to help you solve the equation or inequality.

- | | | |
|-------------------------------|------------------------|----------------------------|
| 40. $2^x = x^2$ | 41. $e^x = \ln(x) + 5$ | 42. $e^{\sqrt{x}} = x + 1$ |
| 43. $e^{-x} - xe^{-x} \geq 0$ | 44. $3^{(x-1)} < 2^x$ | 45. $e^x < x^3 - x$ |
46. Since $f(x) = \ln(x)$ is a strictly increasing function, if $0 < a < b$ then $\ln(a) < \ln(b)$. Use this fact to solve the inequality $e^{(3x-1)} > 6$ without a sign diagram. Use this technique to solve the inequalities in Exercises 34 - 39. (NOTE: Isolate the exponential function first!)
47. Compute the inverse of $f(x) = \frac{e^x - e^{-x}}{2}$. State the domain and range of both f and f^{-1} .

48. In Example 6.3.4, we found that the inverse of $f(x) = \frac{5e^x}{e^x + 1}$ was $f^{-1}(x) = \ln\left(\frac{x}{5-x}\right)$ but we left a few loose ends for you to tie up.
- (a) Show that $(f^{-1} \circ f)(x) = x$ for all x in the domain of f and that $(f \circ f^{-1})(x) = x$ for all x in the domain of f^{-1} .
 - (b) Find the range of f by finding the domain of f^{-1} .
 - (c) Let $g(x) = \frac{5x}{x+1}$ and $h(x) = e^x$. Show that $f = g \circ h$ and that $(g \circ h)^{-1} = h^{-1} \circ g^{-1}$. (We know this is true in general by Exercise 31 in Section 5.2, but it's nice to see a specific example of the property.)
49. With the help of your classmates, solve the inequality $e^x > x^n$ for a variety of natural numbers n . What might you conjecture about the “speed” at which $f(x) = e^x$ grows versus any polynomial?

6.3.2 ANSWERS

1. $x = \frac{3}{4}$
2. $x = 4$
3. $x = 2$
4. $x = -\frac{1}{4}$
5. $x = -\frac{7}{3}$
6. $x = -1, 0, 1$
7. $x = \frac{16}{15}$
8. $x = -\frac{2}{11}$
9. $x = \frac{\ln(5)}{2\ln(3)}$
10. $x = -\frac{\ln(2)}{\ln(5)}$
11. No solution.
12. $x = \frac{\ln(29)+\ln(3)}{\ln(3)}$
13. $x = \frac{\ln(3)}{12\ln(1.005)}$
14. $k = \frac{\ln(\frac{1}{2})}{-5730} = \frac{\ln(2)}{5730}$
15. $t = \frac{\ln(2)}{0.1} = 10\ln(2)$
16. $x = \frac{1}{2}\ln\left(\frac{1}{2}\right) = -\frac{1}{2}\ln(2)$
17. $t = \frac{\ln(\frac{1}{18})}{-0.1} = 10\ln(18)$
18. $x = -10\ln\left(\frac{5}{3}\right) = 10\ln\left(\frac{3}{5}\right)$
19. $x = \ln(2)$
20. $t = \frac{1}{3}\ln(2)$
21. $t = \frac{\ln(\frac{1}{29})}{-0.8} = \frac{5}{4}\ln(29)$
22. $x = \frac{\ln(\frac{2}{5})}{\ln(\frac{4}{5})} = \frac{\ln(2)-\ln(5)}{\ln(4)-\ln(5)}$
23. $x = \ln(2)$
24. $x = -\frac{1}{8}\ln\left(\frac{1}{4}\right) = \frac{1}{4}\ln(2)$
25. $x = \frac{\ln(3)}{\ln(3)-\ln(2)}$
26. $x = \frac{\ln(3)+5\ln(\frac{1}{2})}{\ln(3)-\ln(\frac{1}{2})} = \frac{\ln(3)-5\ln(2)}{\ln(3)+\ln(2)}$
27. $x = \frac{4\ln(3)-3\ln(7)}{7\ln(7)+2\ln(3)}$
28. $x = \ln(5)$
29. $x = \ln(3)$
30. $x = \frac{\ln(3)}{\ln(2)}$
31. $x = \ln(3)$
32. $x = \ln(3), \ln(5)$
33. $x = \frac{\ln(5)}{\ln(3)}$
34. $(\ln(53), \infty)$
35. $\left[\frac{\ln(3)}{12\ln(1.005)}, \infty\right)$
36. $(-\infty, -1) \cup (0, 1)$
37. $\left(-\infty, \frac{\ln(\frac{2}{5})}{\ln(\frac{4}{5})}\right] = \left(-\infty, \frac{\ln(2)-\ln(5)}{\ln(4)-\ln(5)}\right]$
38. $\left(-\infty, \frac{\ln(\frac{2}{377})}{-0.8}\right] = \left(-\infty, \frac{5}{4}\ln\left(\frac{377}{2}\right)\right]$
39. $\left[\frac{\ln(\frac{1}{18})}{-0.1}, \infty\right) = [10\ln(18), \infty)$
40. $x \approx -0.76666, x = 2, x = 4$
41. $x \approx 0.01866, x \approx 1.7115$
42. $x = 0$
43. $(-\infty, 1]$
44. $\approx (-\infty, 2.7095)$
45. $\approx (2.3217, 4.3717)$
46. $x > \frac{1}{3}(\ln(6) + 1)$
47. $f^{-1} = \ln\left(x + \sqrt{x^2 + 1}\right)$. Both f and f^{-1} have domain $(-\infty, \infty)$ and range $(-\infty, \infty)$.

6.4 LOGARITHMIC EQUATIONS AND INEQUALITIES

In Section 6.3 we solved equations and inequalities involving exponential functions using one of two basic strategies. We now turn our attention to equations and inequalities involving logarithmic functions, and not surprisingly, there are two basic strategies to choose from. For example, suppose we wish to solve $\log_2(x) = \log_2(5)$. Theorem 6.4 tells us that the *only* solution to this equation is $x = 5$. Now suppose we wish to solve $\log_2(x) = 3$. If we want to use Theorem 6.4, we need to rewrite 3 as a logarithm base 2. We can use Theorem 6.3 to do just that: $3 = \log_2(2^3) = \log_2(8)$. Our equation then becomes $\log_2(x) = \log_2(8)$ so that $x = 8$. However, we could have arrived at the same answer, in fewer steps, by using Theorem 6.3 to rewrite the equation $\log_2(x) = 3$ as $2^3 = x$, or $x = 8$. We summarize the two common ways to solve log equations below.

Steps for Solving an Equation involving Logarithmic Functions

1. Isolate the logarithmic function.
2. (a) If convenient, express both sides as logs with the same base and equate the arguments of the log functions.
 - (b) Otherwise, rewrite the log equation as an exponential equation.

Example 6.4.1. Solve the following equations. Check your solutions graphically using a calculator.

1. $\log_{117}(1 - 3x) = \log_{117}(x^2 - 3)$
2. $2 - \ln(x - 3) = 1$
3. $\log_6(x + 4) + \log_6(3 - x) = 1$
4. $\log_7(1 - 2x) = 1 - \log_7(3 - x)$
5. $\log_2(x + 3) = \log_2(6 - x) + 3$
6. $1 + 2\log_4(x + 1) = 2\log_2(x)$

Solution.

1. Since we have the same base on both sides of the equation $\log_{117}(1 - 3x) = \log_{117}(x^2 - 3)$, we equate what's inside the logs to get $1 - 3x = x^2 - 3$. Solving $x^2 + 3x - 4 = 0$ gives $x = -4$ and $x = 1$. To check these answers using the calculator, we make use of the change of base formula and graph $f(x) = \frac{\ln(1-3x)}{\ln(117)}$ and $g(x) = \frac{\ln(x^2-3)}{\ln(117)}$ and we see they intersect only at $x = -4$. To see what happened to the solution $x = 1$, we substitute it into our original equation to obtain $\log_{117}(-2) = \log_{117}(-2)$. While these expressions look identical, neither is a real number,¹ which means $x = 1$ is not in the domain of the original equation, and is not a solution.
2. Our first objective in solving $2 - \ln(x - 3) = 1$ is to isolate the logarithm. We get $\ln(x - 3) = 1$, which, as an exponential equation, is $e^1 = x - 3$. We get our solution $x = e + 3$. On the calculator, we see the graph of $f(x) = 2 - \ln(x - 3)$ intersects the graph of $g(x) = 1$ at $x = e + 3 \approx 5.718$.

¹They do, however, represent the same **family** of complex numbers. We stop ourselves at this point and refer the reader to a good course in Complex Variables.

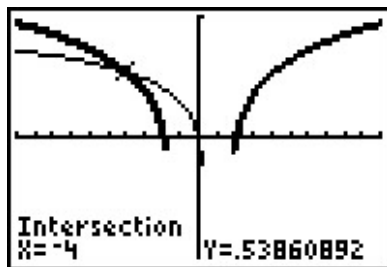

$$y = f(x) = \log_{117}(1 - 3x) \text{ and}$$

$$y = g(x) = \log_{117}(x^2 - 3)$$

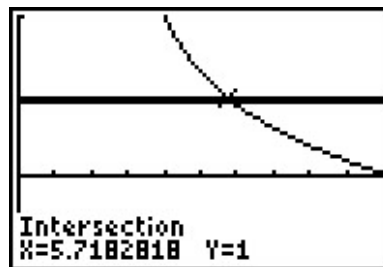

$$y = f(x) = 2 - \ln(x - 3) \text{ and}$$

$$y = g(x) = 1$$

3. We can start solving $\log_6(x+4) + \log_6(3-x) = 1$ by using the Product Rule for logarithms to rewrite the equation as $\log_6[(x+4)(3-x)] = 1$. Rewriting this as an exponential equation, we get $6^1 = (x+4)(3-x)$. This reduces to $x^2 + x - 6 = 0$, which gives $x = -3$ and $x = 2$. Graphing $y = f(x) = \frac{\ln(x+4)}{\ln(6)} + \frac{\ln(3-x)}{\ln(6)}$ and $y = g(x) = 1$, we see they intersect twice, at $x = -3$ and $x = 2$.

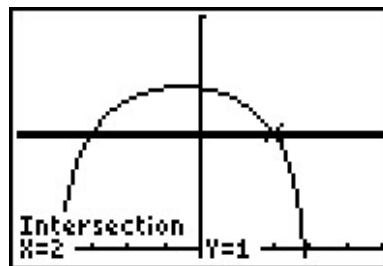
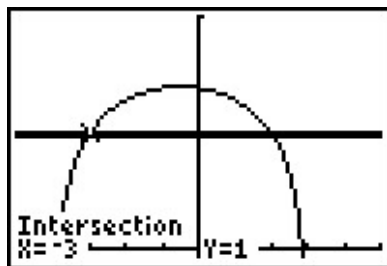

$$y = f(x) = \log_6(x + 4) + \log_6(3 - x) \text{ and } y = g(x) = 1$$

4. Taking a cue from the previous problem, we begin solving $\log_7(1 - 2x) = 1 - \log_7(3 - x)$ by first collecting the logarithms on the same side, $\log_7(1 - 2x) + \log_7(3 - x) = 1$, and then using the Product Rule to get $\log_7[(1 - 2x)(3 - x)] = 1$. Rewriting this as an exponential equation gives $7^1 = (1 - 2x)(3 - x)$ which gives the quadratic equation $2x^2 - 7x - 4 = 0$. Solving, we find $x = -\frac{1}{2}$ and $x = 4$. Graphing, we find $y = f(x) = \frac{\ln(1-2x)}{\ln(7)}$ and $y = g(x) = 1 - \frac{\ln(3-x)}{\ln(7)}$ intersect only at $x = -\frac{1}{2}$. Checking $x = 4$ in the original equation produces $\log_7(-7) = 1 - \log_7(-1)$, which is a clear domain violation.
5. Starting with $\log_2(x + 3) = \log_2(6 - x) + 3$, we gather the logarithms to one side and get $\log_2(x + 3) - \log_2(6 - x) = 3$. We then use the Quotient Rule and convert to an exponential equation

$$\log_2\left(\frac{x+3}{6-x}\right) = 3 \iff 2^3 = \frac{x+3}{6-x}$$

This reduces to the linear equation $8(6 - x) = x + 3$, which gives us $x = 5$. When we graph $f(x) = \frac{\ln(x+3)}{\ln(2)}$ and $g(x) = \frac{\ln(6-x)}{\ln(2)} + 3$, we find they intersect at $x = 5$.

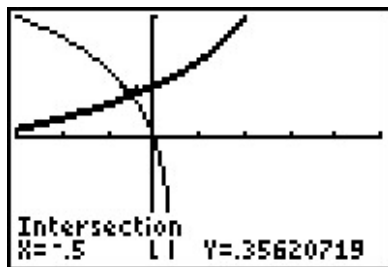

$$y = f(x) = \log_7(1 - 2x) \text{ and}$$

$$y = g(x) = 1 - \log_7(3 - x)$$

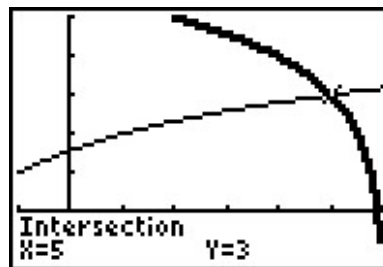

$$y = f(x) = \log_2(x + 3) \text{ and}$$

$$y = g(x) = \log_2(6 - x) + 3$$

6. Starting with $1 + 2 \log_4(x + 1) = 2 \log_2(x)$, we gather the logs to one side to get the equation $1 = 2 \log_2(x) - 2 \log_4(x + 1)$. Before we can combine the logarithms, however, we need a common base. Since 4 is a power of 2, we use change of base to convert

$$\log_4(x + 1) = \frac{\log_2(x + 1)}{\log_2(4)} = \frac{1}{2} \log_2(x + 1)$$

Hence, our original equation becomes

$$1 = 2 \log_2(x) - 2 \left(\frac{1}{2} \log_2(x + 1) \right)$$

$$1 = 2 \log_2(x) - \log_2(x + 1)$$

$$1 = \log_2(x^2) - \log_2(x + 1) \quad \text{Power Rule}$$

$$1 = \log_2 \left(\frac{x^2}{x + 1} \right) \quad \text{Quotient Rule}$$

Rewriting this in exponential form, we get $\frac{x^2}{x+1} = 2$ or $x^2 - 2x - 2 = 0$. Using the quadratic formula, we get $x = 1 \pm \sqrt{3}$. Graphing $f(x) = 1 + \frac{2 \ln(x+1)}{\ln(4)}$ and $g(x) = \frac{2 \ln(x)}{\ln(2)}$, we see the graphs intersect only at $x = 1 + \sqrt{3} \approx 2.732$. The solution $x = 1 - \sqrt{3} < 0$, which means if substituted into the original equation, the term $2 \log_2(1 - \sqrt{3})$ is undefined.

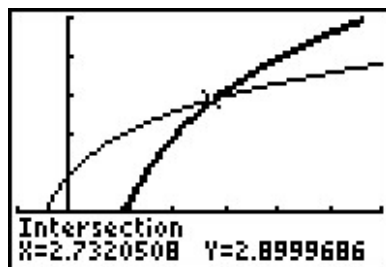

$$y = f(x) = 1 + 2 \log_4(x + 1) \text{ and } y = g(x) = 2 \log_2(x)$$

□

If nothing else, Example 6.4.1 demonstrates the importance of checking for extraneous solutions² when solving equations involving logarithms. Even though we checked our answers graphically, extraneous solutions are easy to spot - any supposed solution which causes a negative number inside a logarithm needs to be discarded. As with the equations in Example 6.3.1, much can be learned from checking all of the answers in Example 6.4.1 analytically. We leave this to the reader and turn our attention to inequalities involving logarithmic functions. Since logarithmic functions are continuous on their domains, we can use sign diagrams.

Example 6.4.2. Solve the following inequalities. Check your answer graphically using a calculator.

$$1. \frac{1}{\ln(x)+1} \leq 1 \qquad 2. (\log_2(x))^2 < 2\log_2(x) + 3 \qquad 3. x \log(x+1) \geq x$$

Solution.

1. We start solving $\frac{1}{\ln(x)+1} \leq 1$ by getting 0 on one side of the inequality: $\frac{1}{\ln(x)+1} - 1 \leq 0$. Getting a common denominator yields $\frac{1}{\ln(x)+1} - \frac{\ln(x)+1}{\ln(x)+1} \leq 0$ which reduces to $\frac{-\ln(x)}{\ln(x)+1} \leq 0$, or $\frac{\ln(x)}{\ln(x)+1} \geq 0$. We define $r(x) = \frac{\ln(x)}{\ln(x)+1}$ and set about finding the domain and the zeros of r . Due to the appearance of the term $\ln(x)$, we require $x > 0$. In order to keep the denominator away from zero, we solve $\ln(x) + 1 = 0$ so $\ln(x) = -1$, so $x = e^{-1} = \frac{1}{e}$. Hence, the domain of r is $(0, \frac{1}{e}) \cup (\frac{1}{e}, \infty)$. To find the zeros of r , we set $r(x) = \frac{\ln(x)}{\ln(x)+1} = 0$ so that $\ln(x) = 0$, and we find $x = e^0 = 1$. In order to determine test values for r without resorting to the calculator, we need to find numbers between $0, \frac{1}{e}$, and 1 which have a base of e . Since $e \approx 2.718 > 1$, $0 < \frac{1}{e^2} < \frac{1}{e} < \frac{1}{\sqrt{e}} < 1 < e$. To determine the sign of $r(\frac{1}{e^2})$, we use the fact that $\ln(\frac{1}{e^2}) = \ln(e^{-2}) = -2$, and find $r(\frac{1}{e^2}) = \frac{-2}{-2+1} = 2$, which is (+). The rest of the test values are determined similarly. From our sign diagram, we find the solution to be $(0, \frac{1}{e}) \cup [1, \infty)$. Graphing $f(x) = \frac{1}{\ln(x)+1}$ and $g(x) = 1$, we see the graph of f is below the graph of g on the solution intervals, and that the graphs intersect at $x = 1$.

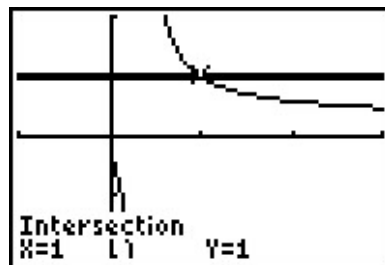
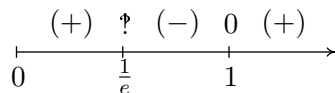

$$y = f(x) = \frac{1}{\ln(x)+1} \text{ and } y = g(x) = 1$$

²Recall that an extraneous solution is an answer obtained analytically which does not satisfy the original equation.

2. Moving all of the nonzero terms of $(\log_2(x))^2 < 2\log_2(x) + 3$ to one side of the inequality, we have $(\log_2(x))^2 - 2\log_2(x) - 3 < 0$. Defining $r(x) = (\log_2(x))^2 - 2\log_2(x) - 3$, we get the domain of r is $(0, \infty)$, due to the presence of the logarithm. To find the zeros of r , we set $r(x) = (\log_2(x))^2 - 2\log_2(x) - 3 = 0$ which results in a ‘quadratic in disguise.’ We set $u = \log_2(x)$ so our equation becomes $u^2 - 2u - 3 = 0$ which gives us $u = -1$ and $u = 3$. Since $u = \log_2(x)$, we get $\log_2(x) = -1$, which gives us $x = 2^{-1} = \frac{1}{2}$, and $\log_2(x) = 3$, which yields $x = 2^3 = 8$. We use test values which are powers of 2: $0 < \frac{1}{4} < \frac{1}{2} < 1 < 8 < 16$, and from our sign diagram, we see $r(x) < 0$ on $(\frac{1}{2}, 8)$. Geometrically, we see the graph of $f(x) = \left(\frac{\ln(x)}{\ln(2)}\right)^2$ is below the graph of $y = g(x) = \frac{2\ln(x)}{\ln(2)} + 3$ on the solution interval.

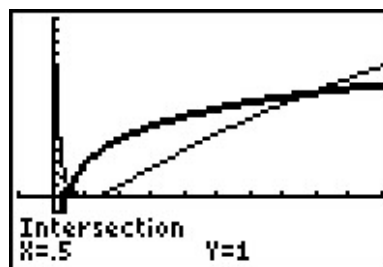
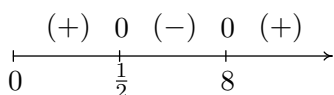

$$y = f(x) = (\log_2(x))^2 \text{ and } y = g(x) = 2\log_2(x) + 3$$

3. We begin to solve $x \log(x+1) \geq x$ by subtracting x from both sides to get $x \log(x+1) - x \geq 0$. We define $r(x) = x \log(x+1) - x$ and due to the presence of the logarithm, we require $x+1 > 0$, or $x > -1$. To find the zeros of r , we set $r(x) = x \log(x+1) - x = 0$. Factoring, we get $x(\log(x+1) - 1) = 0$, which gives $x = 0$ or $\log(x+1) - 1 = 0$. The latter gives $\log(x+1) = 1$, or $x+1 = 10^1$, which admits $x = 9$. We select test values x so that $x+1$ is a power of 10, and we obtain $-1 < -0.9 < 0 < \sqrt{10} - 1 < 9 < 99$. Our sign diagram gives the solution to be $(-1, 0] \cup [9, \infty)$. The calculator indicates the graph of $y = f(x) = x \log(x+1)$ is above $y = g(x) = x$ on the solution intervals, and the graphs intersect at $x = 0$ and $x = 9$.

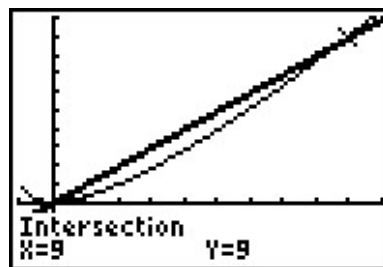
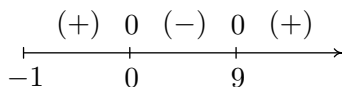

$$y = f(x) = x \log(x+1) \text{ and } y = g(x) = x$$

□

Our next example revisits the concept of pH first seen in Exercise 77 in Section 6.1.

Example 6.4.3. In order to successfully breed Ippizuti fish the pH of a freshwater tank must be at least 7.8 but can be no more than 8.5. Determine the corresponding range of hydrogen ion concentration, and check your answer using a calculator.

Solution. Recall from Exercise 77 in Section 6.1 that $\text{pH} = -\log[\text{H}^+]$ where $[\text{H}^+]$ is the hydrogen ion concentration in moles per liter. We require $7.8 \leq -\log[\text{H}^+] \leq 8.5$ or $-7.8 \geq \log[\text{H}^+] \geq -8.5$. To solve this compound inequality we solve $-7.8 \geq \log[\text{H}^+]$ and $\log[\text{H}^+] \geq -8.5$ and take the intersection of the solution sets.³ The former inequality yields $0 < [\text{H}^+] \leq 10^{-7.8}$ and the latter yields $[\text{H}^+] \geq 10^{-8.5}$. Taking the intersection gives us our final answer $10^{-8.5} \leq [\text{H}^+] \leq 10^{-7.8}$. (Your Chemistry professor may want the answer written as $3.16 \times 10^{-9} \leq [\text{H}^+] \leq 1.58 \times 10^{-8}$.) After carefully adjusting the viewing window on the graphing calculator we see that the graph of $f(x) = -\log(x)$ lies between the lines $y = 7.8$ and $y = 8.5$ on the interval $[3.16 \times 10^{-9}, 1.58 \times 10^{-8}]$.

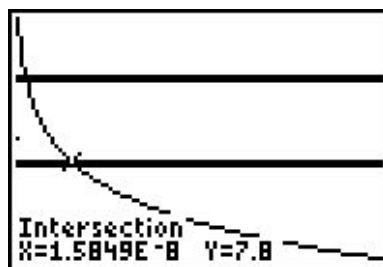
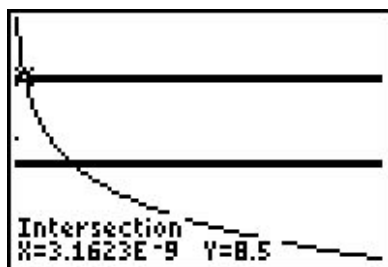

The graphs of $y = f(x) = -\log(x)$, $y = 7.8$ and $y = 8.5$

□

We close this section by finding an inverse of a one-to-one function which involves logarithms.

Example 6.4.4. The function $f(x) = \frac{\log(x)}{1 - \log(x)}$ is one-to-one. Find a formula for $f^{-1}(x)$ and check your answer graphically using your calculator.

Solution. We first write $y = f(x)$ then interchange the x and y and solve for y .

$$\begin{aligned}
 y &= f(x) \\
 y &= \frac{\log(x)}{1 - \log(x)} \\
 x &= \frac{\log(y)}{1 - \log(y)} && \text{Interchange } x \text{ and } y. \\
 x(1 - \log(y)) &= \log(y) \\
 x - x \log(y) &= \log(y) \\
 x &= x \log(y) + \log(y) \\
 x &= (x + 1) \log(y) \\
 \frac{x}{x + 1} &= \log(y) \\
 y &= 10^{\frac{x}{x+1}} && \text{Rewrite as an exponential equation.}
 \end{aligned}$$

³Refer to page 138 for a discussion of what this means.

We have $f^{-1}(x) = 10^{\frac{x}{x+1}}$. Graphing f and f^{-1} on the same viewing window yields

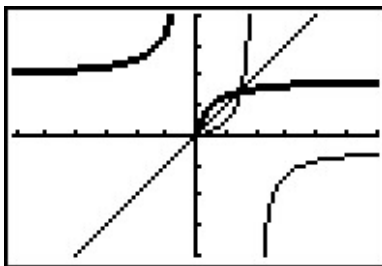

$$y = f(x) = \frac{\log(x)}{1 - \log(x)} \text{ and } y = g(x) = 10^{\frac{x}{x+1}}$$

□

6.4.1 EXERCISES

In Exercises 1 - 24, solve the equation analytically.

1. $\log(3x - 1) = \log(4 - x)$

2. $\log_2(x^3) = \log_2(x)$

3. $\ln(8 - x^2) = \ln(2 - x)$

4. $\log_5(18 - x^2) = \log_5(6 - x)$

5. $\log_3(7 - 2x) = 2$

6. $\log_{\frac{1}{2}}(2x - 1) = -3$

7. $\ln(x^2 - 99) = 0$

8. $\log(x^2 - 3x) = 1$

9. $\log_{125}\left(\frac{3x - 2}{2x + 3}\right) = \frac{1}{3}$

10. $\log\left(\frac{x}{10^{-3}}\right) = 4.7$

11. $-\log(x) = 5.4$

12. $10 \log\left(\frac{x}{10^{-12}}\right) = 150$

13. $6 - 3 \log_5(2x) = 0$

14. $3 \ln(x) - 2 = 1 - \ln(x)$

15. $\log_3(x - 4) + \log_3(x + 4) = 2$

16. $\log_5(2x + 1) + \log_5(x + 2) = 1$

17. $\log_{169}(3x + 7) - \log_{169}(5x - 9) = \frac{1}{2}$

18. $\ln(x + 1) - \ln(x) = 3$

19. $2 \log_7(x) = \log_7(2) + \log_7(x + 12)$

20. $\log(x) - \log(2) = \log(x + 8) - \log(x + 2)$

21. $\log_3(x) = \log_{\frac{1}{3}}(x) + 8$

22. $\ln(\ln(x)) = 3$

23. $(\log(x))^2 = 2 \log(x) + 15$

24. $\ln(x^2) = (\ln(x))^2$

In Exercises 25 - 30, solve the inequality analytically.

25. $\frac{1 - \ln(x)}{x^2} < 0$

26. $x \ln(x) - x > 0$

27. $10 \log\left(\frac{x}{10^{-12}}\right) \geq 90$

28. $5.6 \leq \log\left(\frac{x}{10^{-3}}\right) \leq 7.1$

29. $2.3 < -\log(x) < 5.4$

30. $\ln(x^2) \leq (\ln(x))^2$

In Exercises 31 - 34, use your calculator to help you solve the equation or inequality.

31. $\ln(x) = e^{-x}$

32. $\ln(x) = \sqrt[4]{x}$

33. $\ln(x^2 + 1) \geq 5$

34. $\ln(-2x^3 - x^2 + 13x - 6) < 0$

35. Since $f(x) = e^x$ is a strictly increasing function, if $a < b$ then $e^a < e^b$. Use this fact to solve the inequality $\ln(2x + 1) < 3$ without a sign diagram. Use this technique to solve the inequalities in Exercises 27 - 29. (Compare this to Exercise 46 in Section 6.3.)
36. Solve $\ln(3 - y) - \ln(y) = 2x + \ln(5)$ for y .
37. In Example 6.4.4 we found the inverse of $f(x) = \frac{\log(x)}{1 - \log(x)}$ to be $f^{-1}(x) = 10^{\frac{x}{x+1}}$.
- (a) Show that $(f^{-1} \circ f)(x) = x$ for all x in the domain of f and that $(f \circ f^{-1})(x) = x$ for all x in the domain of f^{-1} .
- (b) Find the range of f by finding the domain of f^{-1} .
- (c) Let $g(x) = \frac{x}{1-x}$ and $h(x) = \log(x)$. Show that $f = g \circ h$ and $(g \circ h)^{-1} = h^{-1} \circ g^{-1}$. (We know this is true in general by Exercise 31 in Section 5.2, but it's nice to see a specific example of the property.)
38. Let $f(x) = \frac{1}{2} \ln\left(\frac{1+x}{1-x}\right)$. Compute $f^{-1}(x)$ and find its domain and range.
39. Explain the equation in Exercise 10 and the inequality in Exercise 28 above in terms of the Richter scale for earthquake magnitude. (See Exercise 75 in Section 6.1.)
40. Explain the equation in Exercise 12 and the inequality in Exercise 27 above in terms of sound intensity level as measured in decibels. (See Exercise 76 in Section 6.1.)
41. Explain the equation in Exercise 11 and the inequality in Exercise 29 above in terms of the pH of a solution. (See Exercise 77 in Section 6.1.)
42. With the help of your classmates, solve the inequality $\sqrt[n]{x} > \ln(x)$ for a variety of natural numbers n . What might you conjecture about the “speed” at which $f(x) = \ln(x)$ grows versus any principal n^{th} root function?

6.4.2 ANSWERS

1. $x = \frac{5}{4}$
2. $x = 1$
3. $x = -2$
4. $x = -3, 4$
5. $x = -1$
6. $x = \frac{9}{2}$
7. $x = \pm 10$
8. $x = -2, 5$
9. $x = -\frac{17}{7}$
10. $x = 10^{1.7}$
11. $x = 10^{-5.4}$
12. $x = 10^3$
13. $x = \frac{25}{2}$
14. $x = e^{3/4}$
15. $x = 5$
16. $x = \frac{1}{2}$
17. $x = 2$
18. $x = \frac{1}{e^3 - 1}$
19. $x = 6$
20. $x = 4$
21. $x = 81$
22. $x = e^{e^3}$
23. $x = 10^{-3}, 10^5$
24. $x = 1, x = e^2$
25. (e, ∞)
26. (e, ∞)
27. $[10^{-3}, \infty)$
28. $[10^{2.6}, 10^{4.1}]$
29. $(10^{-5.4}, 10^{-2.3})$
30. $(0, 1] \cup [e^2, \infty)$
31. $x \approx 1.3098$
32. $x \approx 4.177, x \approx 5503.665$
33. $\approx (-\infty, -12.1414) \cup (12.1414, \infty)$
34. $\approx (-3.0281, -3) \cup (0.5, 0.5991) \cup (1.9299, 2)$
35. $-\frac{1}{2} < x < \frac{e^3 - 1}{2}$
36. $y = \frac{3}{5e^{2x} + 1}$
38. $f^{-1}(x) = \frac{e^{2x} - 1}{e^{2x} + 1} = \frac{e^x - e^{-x}}{e^x + e^{-x}}$. The domain of f^{-1} is $(-\infty, \infty)$ and its range is the same as the domain of f , namely $(-1, 1)$.

6.5 APPLICATIONS OF EXPONENTIAL AND LOGARITHMIC FUNCTIONS

As we mentioned in Section 6.1, exponential and logarithmic functions are used to model a wide variety of behaviors in the real world. In the examples that follow, note that while the applications are drawn from many different disciplines, the mathematics remains essentially the same. Due to the applied nature of the problems we will examine in this section, the calculator is often used to express our answers as decimal approximations.

6.5.1 APPLICATIONS OF EXPONENTIAL FUNCTIONS

Perhaps the most well-known application of exponential functions comes from the financial world. Suppose you have \$100 to invest at your local bank and they are offering a whopping 5% annual percentage interest rate. This means that after one year, the bank will pay *you* 5% of that \$100, or $\$100(0.05) = \5 in interest, so you now have \$105.¹ This is in accordance with the formula for *simple interest* which you have undoubtedly run across at some point before.

Equation 6.1. Simple Interest The amount of interest I accrued at an annual rate r on an investment^a P after t years is

$$I = Prt$$

The amount A in the account after t years is given by

$$A = P + I = P + Prt = P(1 + rt)$$

^aCalled the **principal**

Suppose, however, that six months into the year, you hear of a better deal at a rival bank.² Naturally, you withdraw your money and try to invest it at the higher rate there. Since six months is one half of a year, that initial \$100 yields $\$100(0.05) \left(\frac{1}{2}\right) = \2.50 in interest. You take your \$102.50 off to the competitor and find out that those restrictions which *may* apply actually do apply to you, and you return to your bank which happily accepts your \$102.50 for the remaining six months of the year. To your surprise and delight, at the end of the year your statement reads \$105.06, not \$105 as you had expected.³ Where did those extra six cents come from? For the first six months of the year, interest was earned on the original principal of \$100, but for the second six months, interest was earned on \$102.50, that is, you earned interest on your interest. This is the basic concept behind **compound interest**. In the previous discussion, we would say that the interest was compounded twice, or semiannually.⁴ If more money can be earned by earning interest on interest already earned, a natural question to ask is what happens if the interest is compounded more often, say 4 times a year, which is every three months, or ‘quarterly.’ In this case, the money is in the account for three months, or $\frac{1}{4}$ of a year, at a time. After the first quarter, we have $A = P(1 + rt) = \$100 \left(1 + 0.05 \cdot \frac{1}{4}\right) = \101.25 . We now invest the \$101.25 for the next three

¹How generous of them!

²Some restrictions may apply.

³Actually, the final balance should be \$105.0625.

⁴Using this convention, simple interest after one year is the same as compounding the interest only once.

months and find that at the end of the second quarter, we have $A = \$101.25 \left(1 + 0.05 \cdot \frac{1}{4}\right) \approx \102.51 . Continuing in this manner, the balance at the end of the third quarter is \$103.79, and, at last, we obtain \$105.08. The extra two cents hardly seems worth it, but we see that we do in fact get more money the more often we compound. In order to develop a formula for this phenomenon, we need to do some abstract calculations. Suppose we wish to invest our principal P at an annual rate r and compound the interest n times per year. This means the money sits in the account $\frac{1}{n}$ of a year between compoundings. Let A_k denote the amount in the account after the k^{th} compounding. Then $A_1 = P \left(1 + r \left(\frac{1}{n}\right)\right)$ which simplifies to $A_1 = P \left(1 + \frac{r}{n}\right)$. After the second compounding, we use A_1 as our new principal and get $A_2 = A_1 \left(1 + \frac{r}{n}\right) = \left[P \left(1 + \frac{r}{n}\right)\right] \left(1 + \frac{r}{n}\right) = P \left(1 + \frac{r}{n}\right)^2$. Continuing in this fashion, we get $A_3 = P \left(1 + \frac{r}{n}\right)^3$, $A_4 = P \left(1 + \frac{r}{n}\right)^4$, and so on, so that $A_k = P \left(1 + \frac{r}{n}\right)^k$. Since we compound the interest n times per year, after t years, we have nt compoundings. We have just derived the general formula for compound interest below.

Equation 6.2. Compounded Interest: If an initial principal P is invested at an annual rate r and the interest is compounded n times per year, the amount A in the account after t years is

$$A(t) = P \left(1 + \frac{r}{n}\right)^{nt}$$

If we take $P = 100$, $r = 0.05$, and $n = 4$, Equation 6.2 becomes $A(t) = 100 \left(1 + \frac{0.05}{4}\right)^{4t}$ which reduces to $A(t) = 100(1.0125)^{4t}$. To check this new formula against our previous calculations, we find $A\left(\frac{1}{4}\right) = 100(1.0125)^{4\left(\frac{1}{4}\right)} = 101.25$, $A\left(\frac{1}{2}\right) \approx \102.51 , $A\left(\frac{3}{4}\right) \approx \103.79 , and $A(1) \approx \$105.08$.

Example 6.5.1. Suppose \$2000 is invested in an account which offers 7.125% compounded monthly.

1. Express the amount A in the account as a function of the term of the investment t in years.
2. How much is in the account after 5 years?
3. How long will it take for the initial investment to double?
4. Find and interpret the average rate of change⁵ of the amount in the account from the end of the fourth year to the end of the fifth year, and from the end of the thirty-fourth year to the end of the thirty-fifth year.

Solution.

1. Substituting $P = 2000$, $r = 0.07125$, and $n = 12$ (since interest is compounded *monthly*) into Equation 6.2 yields $A(t) = 2000 \left(1 + \frac{0.07125}{12}\right)^{12t} = 2000(1.0059375)^{12t}$.
2. Since t represents the length of the investment in years, we substitute $t = 5$ into $A(t)$ to find $A(5) = 2000(1.0059375)^{12(5)} \approx 2852.92$. After 5 years, we have approximately \$2852.92.

⁵See Definition 2.3 in Section 2.1.

3. Our initial investment is \$2000, so to find the time it takes this to double, we need to find t when $A(t) = 4000$. We get $2000(1.0059375)^{12t} = 4000$, or $(1.0059375)^{12t} = 2$. Taking natural logs as in Section 6.3, we get $t = \frac{\ln(2)}{12 \ln(1.0059375)} \approx 9.75$. Hence, it takes approximately 9 years 9 months for the investment to double.
4. To find the average rate of change of A from the end of the fourth year to the end of the fifth year, we compute $\frac{A(5)-A(4)}{5-4} \approx 195.63$. Similarly, the average rate of change of A from the end of the thirty-fourth year to the end of the thirty-fifth year is $\frac{A(35)-A(34)}{35-34} \approx 1648.21$. This means that the value of the investment is increasing at a rate of approximately \$195.63 per year between the end of the fourth and fifth years, while that rate jumps to \$1648.21 per year between the end of the thirty-fourth and thirty-fifth years. So, not only is it true that the longer you wait, the more money you have, but also the longer you wait, the faster the money increases.⁶ \square

We have observed that the more times you compound the interest per year, the more money you will earn in a year. Let's push this notion to the limit.⁷ Consider an investment of \$1 invested at 100% interest for 1 year compounded n times a year. Equation 6.2 tells us that the amount of money in the account after 1 year is $A = (1 + \frac{1}{n})^n$. Below is a table of values relating n and A .

n	A
1	2
2	2.25
4	≈ 2.4414
12	≈ 2.6130
360	≈ 2.7145
1000	≈ 2.7169
10000	≈ 2.7181
100000	≈ 2.7182

As promised, the more compoundings per year, the more money there is in the account, but we also observe that the increase in money is greatly diminishing. We are witnessing a mathematical 'tug of war'. While we are compounding more times per year, and hence getting interest on our interest more often, the amount of time between compoundings is getting smaller and smaller, so there is less time to build up additional interest. With Calculus, we can show⁸ that as $n \rightarrow \infty$, $A = (1 + \frac{1}{n})^n \rightarrow e$, where e is the natural base first presented in Section 6.1. Taking the number of compoundings per year to infinity results in what is called **continuously** compounded interest.

Theorem 6.8. If you invest \$1 at 100% interest compounded continuously, then you will have \$ e at the end of one year.

⁶In fact, the rate of increase of the amount in the account is exponential as well. This is the quality that really defines exponential functions and we refer the reader to a course in Calculus.

⁷Once you've had a semester of Calculus, you'll be able to fully appreciate this very lame pun.

⁸Or define, depending on your point of view.

Using this definition of e and a little Calculus, we can take Equation 6.2 and produce a formula for continuously compounded interest.

Equation 6.3. Continuously Compounded Interest: If an initial principal P is invested at an annual rate r and the interest is compounded continuously, the amount A in the account after t years is

$$A(t) = Pe^{rt}$$

If we take the scenario of Example 6.5.1 and compare monthly compounding to continuous compounding over 35 years, we find that monthly compounding yields $A(35) = 2000(1.0059375)^{12(35)}$ which is about \$24,035.28, whereas continuously compounding gives $A(35) = 2000e^{0.07125(35)}$ which is about \$24,213.18 - a difference of less than 1%.

Equations 6.2 and 6.3 both use exponential functions to describe the growth of an investment. Curiously enough, the same principles which govern compound interest are also used to model short term growth of populations. In Biology, **The Law of Uninhibited Growth** states as its premise that the *instantaneous* rate at which a population increases at any time is directly proportional to the population at that time.⁹ In other words, the more organisms there are at a given moment, the faster they reproduce. Formulating the law as stated results in a differential equation, which requires Calculus to solve. Its solution is stated below.

Equation 6.4. Uninhibited Growth: If a population increases according to The Law of Uninhibited Growth, the number of organisms N at time t is given by the formula

$$N(t) = N_0e^{kt},$$

where $N(0) = N_0$ (read ‘ N nought’) is the initial number of organisms and $k > 0$ is the constant of proportionality which satisfies the equation

$$(\text{instantaneous rate of change of } N(t) \text{ at time } t) = kN(t)$$

It is worth taking some time to compare Equations 6.3 and 6.4. In Equation 6.3, we use P to denote the initial investment; in Equation 6.4, we use N_0 to denote the initial population. In Equation 6.3, r denotes the annual interest rate, and so it shouldn’t be too surprising that the k in Equation 6.4 corresponds to a growth rate as well. While Equations 6.3 and 6.4 look entirely different, they both represent the same mathematical concept.

Example 6.5.2. In order to perform arthrosclerosis research, epithelial cells are harvested from discarded umbilical tissue and grown in the laboratory. A technician observes that a culture of twelve thousand cells grows to five million cells in one week. Assuming that the cells follow The Law of Uninhibited Growth, find a formula for the number of cells, N , in thousands, after t days.

Solution. We begin with $N(t) = N_0e^{kt}$. Since N is to give the number of cells *in thousands*, we have $N_0 = 12$, so $N(t) = 12e^{kt}$. In order to complete the formula, we need to determine the

⁹The average rate of change of a function over an interval was first introduced in Section 2.1. *Instantaneous* rates of change are the business of Calculus, as is mentioned on Page 295.

growth rate k . We know that after one week, the number of cells has grown to five million. Since t measures days and the units of N are in thousands, this translates mathematically to $N(7) = 5000$. We get the equation $12e^{7k} = 5000$ which gives $k = \frac{1}{7} \ln\left(\frac{1250}{3}\right)$. Hence, $N(t) = 12e^{\frac{t}{7} \ln\left(\frac{1250}{3}\right)}$. Of course, in practice, we would approximate k to some desired accuracy, say $k \approx 0.8618$, which we can interpret as an 86.18% daily growth rate for the cells. \square

Whereas Equations 6.3 and 6.4 model the growth of quantities, we can use equations like them to describe the decline of quantities. One example we've seen already is Example 6.1.1 in Section 6.1. There, the value of a car declined from its purchase price of \$25,000 to nothing at all. Another real world phenomenon which follows suit is radioactive decay. There are elements which are unstable and emit energy spontaneously. In doing so, the amount of the element itself diminishes. The assumption behind this model is that the rate of decay of an element at a particular time is directly proportional to the amount of the element present at that time. In other words, the more of the element there is, the faster the element decays. This is precisely the same kind of hypothesis which drives The Law of Uninhibited Growth, and as such, the equation governing radioactive decay is hauntingly similar to Equation 6.4 with the exception that the rate constant k is negative.

Equation 6.5. Radioactive Decay The amount of a radioactive element A at time t is given by the formula

$$A(t) = A_0 e^{kt},$$

where $A(0) = A_0$ is the initial amount of the element and $k < 0$ is the constant of proportionality which satisfies the equation

$$(\text{instantaneous rate of change of } A(t) \text{ at time } t) = k A(t)$$

Example 6.5.3. Iodine-131 is a commonly used radioactive isotope used to help detect how well the thyroid is functioning. Suppose the decay of Iodine-131 follows the model given in Equation 6.5, and that the half-life¹⁰ of Iodine-131 is approximately 8 days. If 5 grams of Iodine-131 is present initially, find a function which gives the amount of Iodine-131, A , in grams, t days later.

Solution. Since we start with 5 grams initially, Equation 6.5 gives $A(t) = 5e^{kt}$. Since the half-life is 8 days, it takes 8 days for half of the Iodine-131 to decay, leaving half of it behind. Hence, $A(8) = 2.5$ which means $5e^{8k} = 2.5$. Solving, we get $k = \frac{1}{8} \ln\left(\frac{1}{2}\right) = -\frac{\ln(2)}{8} \approx -0.08664$, which we can interpret as a loss of material at a rate of 8.664% daily. Hence, $A(t) = 5e^{-\frac{t \ln(2)}{8}} \approx 5e^{-0.08664t}$. \square

We now turn our attention to some more mathematically sophisticated models. One such model is Newton's Law of Cooling, which we first encountered in Example 6.1.2 of Section 6.1. In that example we had a cup of coffee cooling from 160°F to room temperature 70°F according to the formula $T(t) = 70 + 90e^{-0.1t}$, where t was measured in minutes. In this situation, we know the physical limit of the temperature of the coffee is room temperature,¹¹ and the differential equation

¹⁰The time it takes for half of the substance to decay.

¹¹The Second Law of Thermodynamics states that heat can spontaneously flow from a hotter object to a colder one, but not the other way around. Thus, the coffee could not continue to release heat into the air so as to cool below room temperature.

which gives rise to our formula for $T(t)$ takes this into account. Whereas the radioactive decay model had a rate of decay at time t directly proportional to the amount of the element which remained at time t , Newton's Law of Cooling states that the rate of cooling of the coffee at a given time t is directly proportional to how much of a temperature gap exists between the coffee at time t and room temperature, not the temperature of the coffee itself. In other words, the coffee cools faster when it is first served, and as its temperature nears room temperature, the coffee cools ever more slowly. Of course, if we take an item from the refrigerator and let it sit out in the kitchen, the object's temperature will rise to room temperature, and since the physics behind warming and cooling is the same, we combine both cases in the equation below.

Equation 6.6. Newton's Law of Cooling (Warming): The temperature T of an object at time t is given by the formula

$$T(t) = T_a + (T_0 - T_a)e^{-kt},$$

where $T(0) = T_0$ is the initial temperature of the object, T_a is the ambient temperature^a and $k > 0$ is the constant of proportionality which satisfies the equation

$$(\text{instantaneous rate of change of } T(t) \text{ at time } t) = k(T(t) - T_a)$$

^aThat is, the temperature of the surroundings.

If we re-examine the situation in Example 6.1.2 with $T_0 = 160$, $T_a = 70$, and $k = 0.1$, we get, according to Equation 6.6, $T(t) = 70 + (160 - 70)e^{-0.1t}$ which reduces to the original formula given. The rate constant $k = 0.1$ indicates the coffee is cooling at a rate equal to 10% of the difference between the temperature of the coffee and its surroundings. Note in Equation 6.6 that the constant k is positive for both the cooling and warming scenarios. What determines if the function $T(t)$ is increasing or decreasing is if T_0 (the initial temperature of the object) is greater than T_a (the ambient temperature) or vice-versa, as we see in our next example.

Example 6.5.4. A 40°F roast is cooked in a 350°F oven. After 2 hours, the temperature of the roast is 125°F.

1. Assuming the temperature of the roast follows Newton's Law of Warming, find a formula for the temperature of the roast T as a function of its time in the oven, t , in hours.
2. The roast is done when the internal temperature reaches 165°F. When will the roast be done?

Solution.

1. The initial temperature of the roast is 40°F, so $T_0 = 40$. The environment in which we are placing the roast is the 350°F oven, so $T_a = 350$. Newton's Law of Warming tells us $T(t) = 350 + (40 - 350)e^{-kt}$, or $T(t) = 350 - 310e^{-kt}$. To determine k , we use the fact that after 2 hours, the roast is 125°F, which means $T(2) = 125$. This gives rise to the equation $350 - 310e^{-2k} = 125$ which yields $k = -\frac{1}{2} \ln\left(\frac{45}{62}\right) \approx 0.1602$. The temperature function is

$$T(t) = 350 - 310e^{\frac{t}{2} \ln\left(\frac{45}{62}\right)} \approx 350 - 310e^{-0.1602t}.$$

2. To determine when the roast is done, we set $T(t) = 165$. This gives $350 - 310e^{-0.1602t} = 165$ whose solution is $t = -\frac{1}{0.1602} \ln\left(\frac{37}{62}\right) \approx 3.22$. It takes roughly 3 hours and 15 minutes to cook the roast completely. \square

If we had taken the time to graph $y = T(t)$ in Example 6.5.4, we would have found the horizontal asymptote to be $y = 350$, which corresponds to the temperature of the oven. We can also arrive at this conclusion by applying a bit of ‘number sense’. As $t \rightarrow \infty$, $-0.1602t \approx$ very big ($-$) so that $e^{-0.1602t} \approx$ very small ($+$). The larger the value of t , the smaller $e^{-0.1602t}$ becomes so that $T(t) \approx 350 -$ very small ($+$), which indicates the graph of $y = T(t)$ is approaching its horizontal asymptote $y = 350$ from below. Physically, this means the roast will eventually warm up to 350°F .¹² The function T is sometimes called a **limited** growth model, since the function T remains bounded as $t \rightarrow \infty$. If we apply the principles behind Newton’s Law of Cooling to a biological example, it says the growth rate of a population is directly proportional to how much room the population has to grow. In other words, the more room for expansion, the faster the growth rate. The **logistic** growth model combines The Law of Uninhibited Growth with limited growth and states that the rate of growth of a population varies jointly with the population itself as well as the room the population has to grow.

Equation 6.7. Logistic Growth: If a population behaves according to the assumptions of logistic growth, the number of organisms N at time t is given by the equation

$$N(t) = \frac{L}{1 + Ce^{-kLt}},$$

where $N(0) = N_0$ is the initial population, L is the limiting population,^a C is a measure of how much room there is to grow given by

$$C = \frac{L}{N_0} - 1.$$

and $k > 0$ is the constant of proportionality which satisfies the equation

$$(\text{instantaneous rate of change of } N(t) \text{ at time } t) = kN(t)(L - N(t))$$

^aThat is, as $t \rightarrow \infty$, $N(t) \rightarrow L$

The logistic function is used not only to model the growth of organisms, but is also often used to model the spread of disease and rumors.¹³

Example 6.5.5. The number of people N , in hundreds, at a local community college who have heard the rumor ‘Carl is afraid of Virginia Woolf’ can be modeled using the logistic equation

$$N(t) = \frac{84}{1 + 2799e^{-t}},$$

¹²at which point it would be more toast than roast.

¹³Which can be just as damaging as diseases.

where $t \geq 0$ is the number of days after April 1, 2009.

1. Find and interpret $N(0)$.
2. Find and interpret the end behavior of $N(t)$.
3. How long until 4200 people have heard the rumor?
4. Check your answers to 2 and 3 using your calculator.

Solution.

1. We find $N(0) = \frac{84}{1+2799e^0} = \frac{84}{2800} = \frac{3}{100}$. Since $N(t)$ measures the number of people who have heard the rumor in hundreds, $N(0)$ corresponds to 3 people. Since $t = 0$ corresponds to April 1, 2009, we may conclude that on that day, 3 people have heard the rumor.¹⁴
2. We could simply note that $N(t)$ is written in the form of Equation 6.7, and identify $L = 84$. However, to see why the answer is 84, we proceed analytically. Since the domain of N is restricted to $t \geq 0$, the only end behavior of significance is $t \rightarrow \infty$. As we've seen before,¹⁵ as $t \rightarrow \infty$, we have $1997e^{-t} \rightarrow 0^+$ and so $N(t) \approx \frac{84}{1+\text{very small } (+)} \approx 84$. Hence, as $t \rightarrow \infty$, $N(t) \rightarrow 84$. This means that as time goes by, the number of people who will have heard the rumor approaches 8400.
3. To find how long it takes until 4200 people have heard the rumor, we set $N(t) = 42$. Solving $\frac{84}{1+2799e^{-t}} = 42$ gives $t = \ln(2799) \approx 7.937$. It takes around 8 days until 4200 people have heard the rumor.
4. We graph $y = N(x)$ using the calculator and see that the line $y = 84$ is the horizontal asymptote of the graph, confirming our answer to part 2, and the graph intersects the line $y = 42$ at $x = \ln(2799) \approx 7.937$, which confirms our answer to part 3.

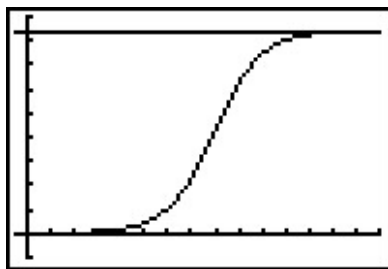

$$y = f(x) = \frac{84}{1+2799e^{-x}} \text{ and } y = 84$$

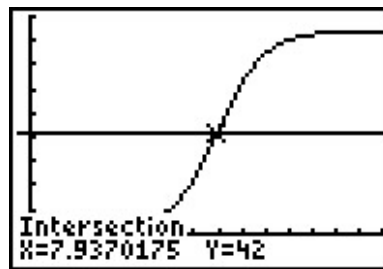

$$y = f(x) = \frac{84}{1+2799e^{-x}} \text{ and } y = 42$$

¹⁴Or, more likely, three people started the rumor. I'd wager Jeff, Jamie, and Jason started it. So much for telling your best friends something in confidence!

¹⁵See, for example, Example 6.1.2.

□

If we take the time to analyze the graph of $y = N(x)$ above, we can see graphically how logistic growth combines features of uninhibited and limited growth. The curve seems to rise steeply, then at some point, begins to level off. The point at which this happens is called an **inflection point** or is sometimes called the ‘point of diminishing returns’. At this point, even though the function is still increasing, the rate at which it does so begins to decline. It turns out the point of diminishing returns always occurs at half the limiting population. (In our case, when $y = 42$.) While these concepts are more precisely quantified using Calculus, below are two views of the graph of $y = N(x)$, one on the interval $[0, 8]$, the other on $[8, 15]$. The former looks strikingly like uninhibited growth; the latter like limited growth.

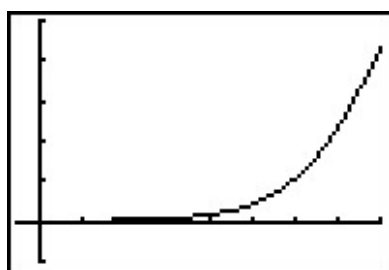

$$y = f(x) = \frac{84}{1+2799e^{-x}} \text{ for } 0 \leq x \leq 8$$

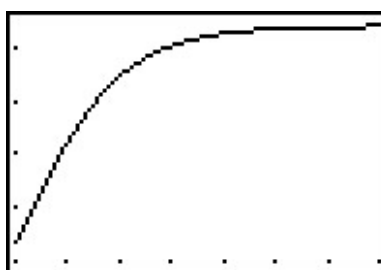

$$y = f(x) = \frac{84}{1+2799e^{-x}} \text{ for } 8 \leq x \leq 16$$

6.5.2 APPLICATIONS OF LOGARITHMS

Just as many physical phenomena can be modeled by exponential functions, the same is true of logarithmic functions. In Exercises 75, 76 and 77 of Section 6.1, we showed that logarithms are useful in measuring the intensities of earthquakes (the Richter scale), sound (decibels) and acids and bases (pH). We now present yet a different use of the a basic logarithm function, [password strength](#).

Example 6.5.6. The [information entropy](#) H , in bits, of a randomly generated password consisting of L characters is given by $H = L \log_2(N)$, where N is the number of possible symbols for each character in the password. In general, the higher the entropy, the stronger the password.

1. If a 7 character case-sensitive¹⁶ password is comprised of letters and numbers only, find the associated information entropy.
2. How many possible symbol options per character is required to produce a 7 character password with an information entropy of 50 bits?

Solution.

1. There are 26 letters in the alphabet, 52 if upper and lower case letters are counted as different. There are 10 digits (0 through 9) for a total of $N = 62$ symbols. Since the password is to be 7 characters long, $L = 7$. Thus, $H = 7 \log_2(62) = \frac{7 \ln(62)}{\ln(2)} \approx 41.68$.

¹⁶That is, upper and lower case letters are treated as different characters.

2. We have $L = 7$ and $H = 50$ and we need to find N . Solving the equation $50 = 7 \log_2(N)$ gives $N = 2^{50/7} \approx 141.323$, so we would need 142 different symbols to choose from.¹⁷ \square

Chemical systems known as [buffer solutions](#) have the ability to adjust to small changes in acidity to maintain a range of pH values. Buffer solutions have a wide variety of applications from maintaining a healthy fish tank to regulating the pH levels in blood. Our next example shows how the pH in a buffer solution is a little more complicated than the pH we first encountered in Exercise 77 in Section 6.1.

Example 6.5.7. Blood is a buffer solution. When carbon dioxide is absorbed into the bloodstream it produces carbonic acid and lowers the pH. The body compensates by producing bicarbonate, a weak base to partially neutralize the acid. The equation¹⁸ which models blood pH in this situation is $\text{pH} = 6.1 + \log\left(\frac{800}{x}\right)$, where x is the partial pressure of carbon dioxide in arterial blood, measured in torr. Find the partial pressure of carbon dioxide in arterial blood if the pH is 7.4.

Solution. We set $\text{pH} = 7.4$ and get $7.4 = 6.1 + \log\left(\frac{800}{x}\right)$, or $\log\left(\frac{800}{x}\right) = 1.3$. Solving, we find $x = \frac{800}{10^{1.3}} \approx 40.09$. Hence, the partial pressure of carbon dioxide in the blood is about 40 torr. \square

Another place logarithms are used is in data analysis. Suppose, for instance, we wish to model the spread of influenza A (H1N1), the so-called ‘Swine Flu’. Below is data taken from the World Health Organization ([WHO](#)) where t represents the number of days since April 28, 2009, and N represents the number of confirmed cases of H1N1 virus worldwide.

t	1	2	3	4	5	6	7	8	9	10	11	12	13
N	148	257	367	658	898	1085	1490	1893	2371	2500	3440	4379	4694

t	14	15	16	17	18	19	20
N	5251	5728	6497	7520	8451	8480	8829

Making a scatter plot of the data treating t as the independent variable and N as the dependent variable gives

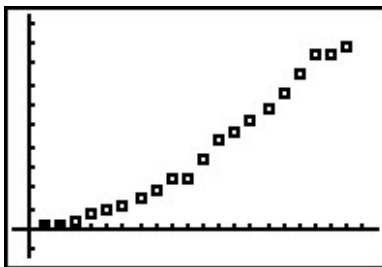

Which models are suggested by the shape of the data? Thinking back Section 2.5, we try a Quadratic Regression, with pretty good results.

¹⁷Since there are only 94 distinct ASCII keyboard characters, to achieve this strength, the number of characters in the password should be increased.

¹⁸Derived from the [Henderson-Hasselbalch Equation](#). See Exercise 43 in Section 6.2. Hasselbalch himself was studying carbon dioxide dissolving in blood - a process called [metabolic acidosis](#).

```

QuadReg
y=ax2+bx+c
a=16.71303258
b=149.6789474
c=-223.1491228
R2=.9917669998

```

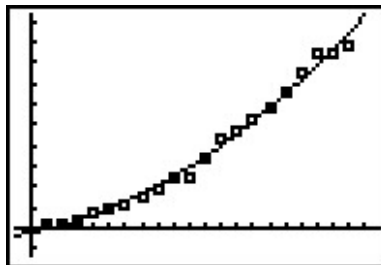

However, is there any scientific reason for the data to be quadratic? Are there other models which fit the data equally well, or better? Scientists often use logarithms in an attempt to ‘linearize’ data sets - in other words, transform the data sets to produce ones which result in straight lines. To see how this could work, suppose we guessed the relationship between N and t was some kind of power function, not necessarily quadratic, say $N = Bt^A$. To try to determine the A and B , we can take the natural log of both sides and get $\ln(N) = \ln(Bt^A)$. Using properties of logs to expand the right hand side of this equation, we get $\ln(N) = A \ln(t) + \ln(B)$. If we set $X = \ln(t)$ and $Y = \ln(N)$, this equation becomes $Y = AX + \ln(B)$. In other words, we have a line with slope A and Y -intercept $\ln(B)$. So, instead of plotting N versus t , we plot $\ln(N)$ versus $\ln(t)$.

$\ln(t)$	0	0.693	1.099	1.386	1.609	1.792	1.946	2.079	2.197	2.302	2.398	2.485	2.565
$\ln(N)$	4.997	5.549	5.905	6.489	6.800	6.989	7.306	7.546	7.771	7.824	8.143	8.385	8.454

$\ln(t)$	2.639	2.708	2.773	2.833	2.890	2.944	2.996
$\ln(N)$	8.566	8.653	8.779	8.925	9.042	9.045	9.086

Running a linear regression on the data gives

```

LinReg
y=ax+b
a=1.511621138
b=4.513068438
r2=.9814139399
r=.9906633837

```

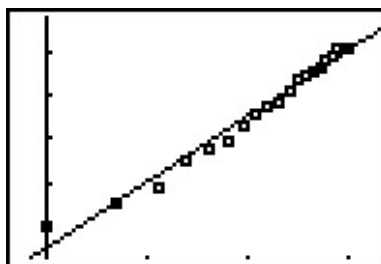

The slope of the regression line is $a \approx 1.512$ which corresponds to our exponent A . The y -intercept $b \approx 4.513$ corresponds to $\ln(B)$, so that $B \approx 91.201$. Hence, we get the model $N = 91.201t^{1.512}$, something from Section 5.3. Of course, the calculator has a built-in ‘Power Regression’ feature. If we apply this to our original data set, we get the same model we arrived at before.¹⁹

¹⁹Critics may question why the authors of the book have chosen to even discuss linearization of data when the calculator has a Power Regression built-in and ready to go. Our response: talk to your science faculty.

```

PwrReg
y=a*x^b
a=91.20123492
b=1.511621138
r^2=.9814139399
r=.9906633837

```

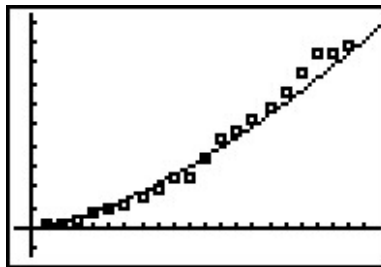

This is all well and good, but the quadratic model appears to fit the data better, and we've yet to mention any scientific principle which would lead us to believe the actual spread of the flu follows any kind of power function at all. If we are to attack this data from a scientific perspective, it does seem to make sense that, at least in the early stages of the outbreak, the more people who have the flu, the faster it will spread, which leads us to proposing an uninhibited growth model. If we assume $N = Be^{At}$ then, taking logs as before, we get $\ln(N) = At + \ln(B)$. If we set $X = t$ and $Y = \ln(N)$, then, once again, we get $Y = AX + \ln(B)$, a line with slope A and Y -intercept $\ln(B)$. Plotting $\ln(N)$ versus t gives the following linear regression.

```

LinReg
y=ax+b
a=.2015800733
b=5.596248304
r^2=.9248161731
r=.9616736313

```

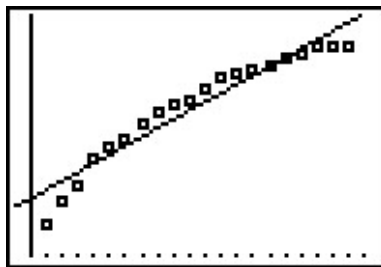

We see the slope is $a \approx 0.202$ and which corresponds to A in our model, and the y -intercept is $b \approx 5.596$ which corresponds to $\ln(B)$. We get $B \approx 269.414$, so that our model is $N = 269.414e^{0.202t}$. Of course, the calculator has a built-in 'Exponential Regression' feature which produces what appears to be a different model $N = 269.414(1.22333419)^t$. Using properties of exponents, we write $e^{0.202t} = (e^{0.202})^t \approx (1.223848)^t$, which, had we carried more decimal places, would have matched the base of the calculator model exactly.

```

ExpReg
y=a*b^x
a=269.4137506
b=1.22333419
r^2=.9248161731
r=.9616736313

```

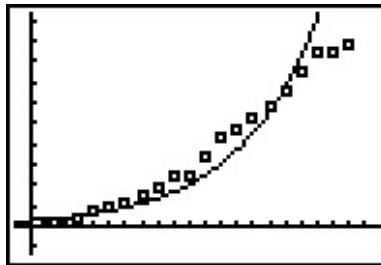

The exponential model didn't fit the data as well as the quadratic or power function model, but it stands to reason that, perhaps, the spread of the flu is not unlike that of the spread of a rumor

and that a logistic model can be used to model the data. The calculator does have a ‘Logistic Regression’ feature, and using it produces the model $N = \frac{10739.147}{1+42.416e^{0.268t}}$.

```

Logistic
y=c/(1+ae^(-bx))
a=42.41647582
b=.267807066
c=10739.14742

```

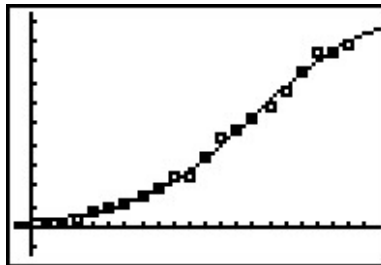

This appears to be an excellent fit, but there is no friendly coefficient of determination, R^2 , by which to judge this numerically. There are good reasons for this, but they are far beyond the scope of the text. Which of the models, quadratic, power, exponential, or logistic is the ‘best model’? If by ‘best’ we mean ‘fits closest to the data,’ then the quadratic and logistic models are arguably the winners with the power function model a close second. However, if we think about the science behind the spread of the flu, the logistic model gets an edge. For one thing, it takes into account that only a finite number of people will ever get the flu (according to our model, 10,739), whereas the quadratic model predicts no limit to the number of cases. As we have stated several times before in the text, mathematical models, regardless of their sophistication, are just that: models, and they all have their limitations.²⁰

²⁰Speaking of limitations, as of June 3, 2009, there were 19,273 confirmed cases of influenza A (H1N1). This is well above our prediction of 10,739. Each time a new report is issued, the data set increases and the model must be recalculated. We leave this recalculation to the reader.

6.5.3 EXERCISES

For each of the scenarios given in Exercises 1 - 6,

- Find the amount A in the account as a function of the term of the investment t in years.
 - Determine how much is in the account after 5 years, 10 years, 30 years and 35 years. Round your answers to the nearest cent.
 - Determine how long will it take for the initial investment to double. Round your answer to the nearest year.
 - Find and interpret the average rate of change of the amount in the account from the end of the fourth year to the end of the fifth year, and from the end of the thirty-fourth year to the end of the thirty-fifth year. Round your answer to two decimal places.
1. \$500 is invested in an account which offers 0.75%, compounded monthly.
 2. \$500 is invested in an account which offers 0.75%, compounded continuously.
 3. \$1000 is invested in an account which offers 1.25%, compounded monthly.
 4. \$1000 is invested in an account which offers 1.25%, compounded continuously.
 5. \$5000 is invested in an account which offers 2.125%, compounded monthly.
 6. \$5000 is invested in an account which offers 2.125%, compounded continuously.
 7. Look back at your answers to Exercises 1 - 6. What can be said about the difference between monthly compounding and continuously compounding the interest in those situations? With the help of your classmates, discuss scenarios where the difference between monthly and continuously compounded interest would be more dramatic. Try varying the interest rate, the term of the investment and the principal. Use computations to support your answer.
 8. How much money needs to be invested now to obtain \$2000 in 3 years if the interest rate in a savings account is 0.25%, compounded continuously? Round your answer to the nearest cent.
 9. How much money needs to be invested now to obtain \$5000 in 10 years if the interest rate in a CD is 2.25%, compounded monthly? Round your answer to the nearest cent.
 10. On May, 31, 2009, the Annual Percentage Rate listed at Jeff's bank for regular savings accounts was 0.25% compounded monthly. Use Equation 6.2 to answer the following.
 - (a) If $P = 2000$ what is $A(8)$?
 - (b) Solve the equation $A(t) = 4000$ for t .
 - (c) What principal P should be invested so that the account balance is \$2000 in three years?

11. Jeff's bank also offers a 36-month Certificate of Deposit (CD) with an APR of 2.25%.
- If $P = 2000$ what is $A(8)$?
 - Solve the equation $A(t) = 4000$ for t .
 - What principal P should be invested so that the account balance is \$2000 in three years?
 - The Annual Percentage Yield is the simple interest rate that returns the same amount of interest after one year as the compound interest does. With the help of your classmates, compute the APY for this investment.
12. A finance company offers a promotion on \$5000 loans. The borrower does not have to make any payments for the first three years, however interest will continue to be charged to the loan at 29.9% compounded continuously. What amount will be due at the end of the three year period, assuming no payments are made? If the promotion is extended an additional three years, and no payments are made, what amount would be due?
13. Use Equation 6.2 to show that the time it takes for an investment to double in value does not depend on the principal P , but rather, depends only on the APR and the number of compoundings per year. Let $n = 12$ and with the help of your classmates compute the doubling time for a variety of rates r . Then look up the Rule of 72 and compare your answers to what that rule says. If you're really interested²¹ in Financial Mathematics, you could also compare and contrast the Rule of 72 with the Rule of 70 and the Rule of 69.

In Exercises 14 - 18, we list some radioactive isotopes and their associated half-lives. Assume that each decays according to the formula $A(t) = A_0 e^{kt}$ where A_0 is the initial amount of the material and k is the decay constant. For each isotope:

- Find the decay constant k . Round your answer to four decimal places.
 - Find a function which gives the amount of isotope A which remains after time t . (Keep the units of A and t the same as the given data.)
 - Determine how long it takes for 90% of the material to decay. Round your answer to two decimal places. (HINT: If 90% of the material decays, how much is left?)
14. Cobalt 60, used in food irradiation, initial amount 50 grams, half-life of 5.27 years.
15. Phosphorus 32, used in agriculture, initial amount 2 milligrams, half-life 14 days.
16. Chromium 51, used to track red blood cells, initial amount 75 milligrams, half-life 27.7 days.
17. Americium 241, used in smoke detectors, initial amount 0.29 micrograms, half-life 432.7 years.
18. Uranium 235, used for nuclear power, initial amount 1 kg grams, half-life 704 million years.

²¹Awesome pun!

19. With the help of your classmates, show that the time it takes for 90% of each isotope listed in Exercises 14 - 18 to decay does not depend on the initial amount of the substance, but rather, on only the decay constant k . Find a formula, in terms of k only, to determine how long it takes for 90% of a radioactive isotope to decay.
20. In Example 6.1.1 in Section 6.1, the exponential function $V(x) = 25 \left(\frac{4}{5}\right)^x$ was used to model the value of a car over time. Use the properties of logs and/or exponents to rewrite the model in the form $V(t) = 25e^{kt}$.
21. The Gross Domestic Product (GDP) of the US (in billions of dollars) t years after the year 2000 can be modeled by:

$$G(t) = 9743.77e^{0.0514t}$$

- (a) Find and interpret $G(0)$.
- (b) According to the model, what should have been the GDP in 2007? In 2010? (According to the [US Department of Commerce](#), the 2007 GDP was \$14,369.1 billion and the 2010 GDP was \$14,657.8 billion.)
22. The diameter D of a tumor, in millimeters, t days after it is detected is given by:

$$D(t) = 15e^{0.0277t}$$

- (a) What was the diameter of the tumor when it was originally detected?
- (b) How long until the diameter of the tumor doubles?
23. Under optimal conditions, the growth of a certain strain of *E. Coli* is modeled by the Law of Uninhibited Growth $N(t) = N_0e^{kt}$ where N_0 is the initial number of bacteria and t is the elapsed time, measured in minutes. From numerous experiments, it has been determined that the doubling time of this organism is 20 minutes. Suppose 1000 bacteria are present initially.
- (a) Find the growth constant k . Round your answer to four decimal places.
- (b) Find a function which gives the number of bacteria $N(t)$ after t minutes.
- (c) How long until there are 9000 bacteria? Round your answer to the nearest minute.
24. Yeast is often used in biological experiments. A research technician estimates that a sample of yeast suspension contains 2.5 million organisms per cubic centimeter (cc). Two hours later, she estimates the population density to be 6 million organisms per cc. Let t be the time elapsed since the first observation, measured in hours. Assume that the yeast growth follows the Law of Uninhibited Growth $N(t) = N_0e^{kt}$.
- (a) Find the growth constant k . Round your answer to four decimal places.
- (b) Find a function which gives the number of yeast (in millions) per cc $N(t)$ after t hours.
- (c) What is the doubling time for this strain of yeast?

25. The Law of Uninhibited Growth also applies to situations where an animal is re-introduced into a suitable environment. Such a case is the reintroduction of wolves to Yellowstone National Park. According to the [National Park Service](#), the wolf population in Yellowstone National Park was 52 in 1996 and 118 in 1999. Using these data, find a function of the form $N(t) = N_0e^{kt}$ which models the number of wolves t years after 1996. (Use $t = 0$ to represent the year 1996. Also, round your value of k to four decimal places.) According to the model, how many wolves were in Yellowstone in 2002? (The recorded number is 272.)
26. During the early years of a community, it is not uncommon for the population to grow according to the Law of Uninhibited Growth. According to the Painesville Wikipedia entry, in 1860, the Village of Painesville had a population of 2649. In 1920, the population was 7272. Use these two data points to fit a model of the form $N(t) = N_0e^{kt}$ where $N(t)$ is the number of Painesville Residents t years after 1860. (Use $t = 0$ to represent the year 1860. Also, round the value of k to four decimal places.) According to this model, what was the population of Painesville in 2010? (The 2010 census gave the population as 19,563) What could be some causes for such a vast discrepancy? For more on this, see Exercise 37.
27. The population of Sasquatch in Bigfoot county is modeled by

$$P(t) = \frac{120}{1 + 3.167e^{-0.05t}}$$

where $P(t)$ is the population of Sasquatch t years after 2010.

- Find and interpret $P(0)$.
 - Find the population of Sasquatch in Bigfoot county in 2013. Round your answer to the nearest Sasquatch.
 - When will the population of Sasquatch in Bigfoot county reach 60? Round your answer to the nearest year.
 - Find and interpret the end behavior of the graph of $y = P(t)$. Check your answer using a graphing utility.
28. The half-life of the radioactive isotope Carbon-14 is about 5730 years.
- Use Equation 6.5 to express the amount of Carbon-14 left from an initial N milligrams as a function of time t in years.
 - What percentage of the original amount of Carbon-14 is left after 20,000 years?
 - If an old wooden tool is found in a cave and the amount of Carbon-14 present in it is estimated to be only 42% of the original amount, approximately how old is the tool?
 - Radiocarbon dating is not as easy as these exercises might lead you to believe. With the help of your classmates, research radiocarbon dating and discuss why our model is somewhat over-simplified.

29. Carbon-14 cannot be used to date inorganic material such as rocks, but there are many other methods of radiometric dating which estimate the age of rocks. One of them, Rubidium-Strontium dating, uses Rubidium-87 which decays to Strontium-87 with a half-life of 50 billion years. Use Equation 6.5 to express the amount of Rubidium-87 left from an initial 2.3 micrograms as a function of time t in *billions* of years. Research this and other radiometric techniques and discuss the margins of error for various methods with your classmates.
30. Use Equation 6.5 to show that $k = -\frac{\ln(2)}{h}$ where h is the half-life of the radioactive isotope.
31. A pork roast²² was taken out of a hardwood smoker when its internal temperature had reached 180°F and it was allowed to rest in a 75°F house for 20 minutes after which its internal temperature had dropped to 170°F. Assuming that the temperature of the roast follows Newton's Law of Cooling (Equation 6.6),
- Express the temperature T (in °F) as a function of time t (in minutes).
 - Find the time at which the roast would have dropped to 140°F had it not been carved and eaten.
32. In reference to Exercise 44 in Section 5.3, if Fritzy the Fox's speed is the same as Chewbacca the Bunny's speed, Fritzy's pursuit curve is given by

$$y(x) = \frac{1}{4}x^2 - \frac{1}{4}\ln(x) - \frac{1}{4}$$

Use your calculator to graph this path for $x > 0$. Describe the behavior of y as $x \rightarrow 0^+$ and interpret this physically.

33. The current i measured in amps in a certain electronic circuit with a constant impressed voltage of 120 volts is given by $i(t) = 2 - 2e^{-10t}$ where $t \geq 0$ is the number of seconds after the circuit is switched on. Determine the value of i as $t \rightarrow \infty$. (This is called the **steady state** current.)
34. If the voltage in the circuit in Exercise 33 above is switched off after 30 seconds, the current is given by the piecewise-defined function

$$i(t) = \begin{cases} 2 - 2e^{-10t} & \text{if } 0 \leq t < 30 \\ (2 - 2e^{-300})e^{-10t+300} & \text{if } t \geq 30 \end{cases}$$

With the help of your calculator, graph $y = i(t)$ and discuss with your classmates the physical significance of the two parts of the graph $0 \leq t < 30$ and $t \geq 30$.

²²This roast was enjoyed by Jeff and his family on June 10, 2009. This is real data, folks!

35. In Exercise 26 in Section 2.3, we stated that the cable of a suspension bridge formed a parabola but that a free hanging cable did not. A free hanging cable forms a catenary and its basic shape is given by $y = \frac{1}{2}(e^x + e^{-x})$. Use your calculator to graph this function. What are its domain and range? What is its end behavior? Is it invertible? How do you think it is related to the function given in Exercise 47 in Section 6.3 and the one given in the answer to Exercise 38 in Section 6.4? When flipped upside down, the catenary makes an arch. The Gateway Arch in St. Louis, Missouri has the shape

$$y = 757.7 - \frac{127.7}{2} \left(e^{\frac{x}{127.7}} + e^{-\frac{x}{127.7}} \right)$$

where x and y are measured in feet and $-315 \leq x \leq 315$. Find the highest point on the arch.

36. In Exercise 6a in Section 2.5, we examined the data set given below which showed how two cats and their surviving offspring can produce over 80 million cats in just ten years. It is virtually impossible to see this data plotted on your calculator, so plot x versus $\ln(x)$ as was done on page 614. Find a linear model for this new data and comment on its goodness of fit. Find an exponential model for the original data and comment on its goodness of fit.

Year x	1	2	3	4	5	6	7	8	9	10
Number of Cats $N(x)$	12	66	382	2201	12680	73041	420715	2423316	13968290	80399780

37. This exercise is a follow-up to Exercise 26 which more thoroughly explores the population growth of Painesville, Ohio. According to [Wikipedia](#), the population of Painesville, Ohio is given by

Year t	1860	1870	1880	1890	1900	1910	1920	1930	1940	1950
Population	2649	3728	3841	4755	5024	5501	7272	10944	12235	14432

Year t	1960	1970	1980	1990	2000
Population	16116	16536	16351	15699	17503

- (a) Use a graphing utility to perform an exponential regression on the data from 1860 through 1920 only, letting $t = 0$ represent the year 1860 as before. How does this calculator model compare with the model you found in Exercise 26? Use the calculator's exponential model to predict the population in 2010. (The 2010 census gave the population as 19,563)
- (b) The logistic model fit to *all* of the given data points for the population of Painesville t years after 1860 (again, using $t = 0$ as 1860) is

$$P(t) = \frac{18691}{1 + 9.8505e^{-0.03617t}}$$

According to this model, what should the population of Painesville have been in 2010? (The 2010 census gave the population as 19,563.) What is the population limit of Painesville?

38. According to [OhioBiz](#), the census data for Lake County, Ohio is as follows:

Year t	1860	1870	1880	1890	1900	1910	1920	1930	1940	1950
Population	15576	15935	16326	18235	21680	22927	28667	41674	50020	75979

Year t	1960	1970	1980	1990	2000
Population	148700	197200	212801	215499	227511

- (a) Use your calculator to fit a logistic model to these data, using $x = 0$ to represent the year 1860.
- (b) Graph these data and your logistic function on your calculator to judge the reasonableness of the fit.
- (c) Use this model to estimate the population of Lake County in 2010. (The 2010 census gave the population to be 230,041.)
- (d) According to your model, what is the population limit of Lake County, Ohio?
39. According to [facebook](#), the number of active users of facebook has grown significantly since its initial launch from a Harvard dorm room in February 2004. The chart below has the approximate number $U(x)$ of active users, in millions, x months after February 2004. For example, the first entry (10, 1) means that there were 1 million active users in December 2004 and the last entry (77, 500) means that there were 500 million active users in July 2010.

Month x	10	22	34	38	44	54	59	60	62	65	67	70	72	77
Active Users in Millions $U(x)$	1	5.5	12	20	50	100	150	175	200	250	300	350	400	500

With the help of your classmates, find a model for this data.

40. Each Monday during the registration period before the Fall Semester at LCCC, the Enrollment Planning Council gets a report prepared by the data analysts in Institutional Effectiveness and Planning.²³ While the ongoing enrollment data is analyzed in many different ways, we shall focus only on the overall headcount. Below is a chart of the enrollment data for Fall Semester 2008. It starts 21 weeks before “Opening Day” and ends on “Day 15” of the semester, but we have relabeled the top row to be $x = 1$ through $x = 24$ so that the math is easier. (Thus, $x = 22$ is Opening Day.)

Week x	1	2	3	4	5	6	7	8
Total Headcount	1194	1564	2001	2475	2802	3141	3527	3790

Week x	9	10	11	12	13	14	15	16
Total Headcount	4065	4371	4611	4945	5300	5657	6056	6478

²³The authors thank Dr. Wendy Marley and her staff for this data and Dr. Marcia Ballinger for the permission to use it in this problem.

Week x	17	18	19	20	21	22	23	24
Total Headcount	7161	7772	8505	9256	10201	10743	11102	11181

With the help of your classmates, find a model for this data. Unlike most of the phenomena we have studied in this section, there is no single differential equation which governs the enrollment growth. Thus there is no scientific reason to rely on a logistic function even though the data plot may lead us to that model. What are some factors which influence enrollment at a community college and how can you take those into account mathematically?

41. When we wrote this exercise, the Enrollment Planning Report for Fall Semester 2009 had only 10 data points for the first 10 weeks of the registration period. Those numbers are given below.

Week x	1	2	3	4	5	6	7	8	9	10
Total Headcount	1380	2000	2639	3153	3499	3831	4283	4742	5123	5398

With the help of your classmates, find a model for this data and make a prediction for the Opening Day enrollment as well as the Day 15 enrollment. (WARNING: The registration period for 2009 was one week shorter than it was in 2008 so Opening Day would be $x = 21$ and Day 15 is $x = 23$.)

6.5.4 ANSWERS

1.
 - $A(t) = 500 \left(1 + \frac{0.0075}{12}\right)^{12t}$
 - $A(5) \approx \$519.10$, $A(10) \approx \$538.93$, $A(30) \approx \$626.12$, $A(35) \approx \$650.03$
 - It will take approximately 92 years for the investment to double.
 - The average rate of change from the end of the fourth year to the end of the fifth year is approximately 3.88. This means that the investment is growing at an average rate of \$3.88 per year at this point. The average rate of change from the end of the thirty-fourth year to the end of the thirty-fifth year is approximately 4.85. This means that the investment is growing at an average rate of \$4.85 per year at this point.
2.
 - $A(t) = 500e^{0.0075t}$
 - $A(5) \approx \$519.11$, $A(10) \approx \$538.94$, $A(30) \approx \$626.16$, $A(35) \approx \$650.09$
 - It will take approximately 92 years for the investment to double.
 - The average rate of change from the end of the fourth year to the end of the fifth year is approximately 3.88. This means that the investment is growing at an average rate of \$3.88 per year at this point. The average rate of change from the end of the thirty-fourth year to the end of the thirty-fifth year is approximately 4.86. This means that the investment is growing at an average rate of \$4.86 per year at this point.
3.
 - $A(t) = 1000 \left(1 + \frac{0.0125}{12}\right)^{12t}$
 - $A(5) \approx \$1064.46$, $A(10) \approx \$1133.07$, $A(30) \approx \$1454.71$, $A(35) \approx \$1548.48$
 - It will take approximately 55 years for the investment to double.
 - The average rate of change from the end of the fourth year to the end of the fifth year is approximately 13.22. This means that the investment is growing at an average rate of \$13.22 per year at this point. The average rate of change from the end of the thirty-fourth year to the end of the thirty-fifth year is approximately 19.23. This means that the investment is growing at an average rate of \$19.23 per year at this point.
4.
 - $A(t) = 1000e^{0.0125t}$
 - $A(5) \approx \$1064.49$, $A(10) \approx \$1133.15$, $A(30) \approx \$1454.99$, $A(35) \approx \$1548.83$
 - It will take approximately 55 years for the investment to double.
 - The average rate of change from the end of the fourth year to the end of the fifth year is approximately 13.22. This means that the investment is growing at an average rate of \$13.22 per year at this point. The average rate of change from the end of the thirty-fourth year to the end of the thirty-fifth year is approximately 19.24. This means that the investment is growing at an average rate of \$19.24 per year at this point.
5.
 - $A(t) = 5000 \left(1 + \frac{0.02125}{12}\right)^{12t}$
 - $A(5) \approx \$5559.98$, $A(10) \approx \$6182.67$, $A(30) \approx \$9453.40$, $A(35) \approx \$10512.13$
 - It will take approximately 33 years for the investment to double.

- The average rate of change from the end of the fourth year to the end of the fifth year is approximately 116.80. This means that the investment is growing at an average rate of \$116.80 per year at this point. The average rate of change from the end of the thirty-fourth year to the end of the thirty-fifth year is approximately 220.83. This means that the investment is growing at an average rate of \$220.83 per year at this point.
6. • $A(t) = 5000e^{0.02125t}$
- $A(5) \approx \$5560.50$, $A(10) \approx \$6183.83$, $A(30) \approx \$9458.73$, $A(35) \approx \$10519.05$
 - It will take approximately 33 years for the investment to double.
 - The average rate of change from the end of the fourth year to the end of the fifth year is approximately 116.91. This means that the investment is growing at an average rate of \$116.91 per year at this point. The average rate of change from the end of the thirty-fourth year to the end of the thirty-fifth year is approximately 221.17. This means that the investment is growing at an average rate of \$221.17 per year at this point.
8. $P = \frac{2000}{e^{0.0025 \cdot 3}} \approx \1985.06
9. $P = \frac{5000}{\left(1 + \frac{0.0225}{12}\right)^{12 \cdot 10}} \approx \3993.42
10. (a) $A(8) = 2000 \left(1 + \frac{0.0025}{12}\right)^{12 \cdot 8} \approx \2040.40
- (b) $t = \frac{\ln(2)}{12 \ln \left(1 + \frac{0.0025}{12}\right)} \approx 277.29$ years
- (c) $P = \frac{2000}{\left(1 + \frac{0.0025}{12}\right)^{36}} \approx \1985.06
11. (a) $A(8) = 2000 \left(1 + \frac{0.0225}{12}\right)^{12 \cdot 8} \approx \2394.03
- (b) $t = \frac{\ln(2)}{12 \ln \left(1 + \frac{0.0225}{12}\right)} \approx 30.83$ years
- (c) $P = \frac{2000}{\left(1 + \frac{0.0225}{12}\right)^{36}} \approx \1869.57
- (d) $\left(1 + \frac{0.0225}{12}\right)^{12} \approx 1.0227$ so the APY is 2.27%
12. $A(3) = 5000e^{0.299 \cdot 3} \approx \$12,226.18$, $A(6) = 5000e^{0.299 \cdot 6} \approx \$30,067.29$
14. • $k = \frac{\ln(1/2)}{5.27} \approx -0.1315$
- $A(t) = 50e^{-0.1315t}$
 - $t = \frac{\ln(0.1)}{-0.1315} \approx 17.51$ years.
15. • $k = \frac{\ln(1/2)}{14} \approx -0.0495$
- $A(t) = 2e^{-0.0495t}$
 - $t = \frac{\ln(0.1)}{-0.0495} \approx 46.52$ days.

16. • $k = \frac{\ln(1/2)}{27.7} \approx -0.0250$
 • $A(t) = 75e^{-0.0250t}$
 • $t = \frac{\ln(0.1)}{-0.025} \approx 92.10$ days.
17. • $k = \frac{\ln(1/2)}{432.7} \approx -0.0016$
 • $A(t) = 0.29e^{-0.0016t}$
 • $t = \frac{\ln(0.1)}{-0.0016} \approx 1439.11$ years.
18. • $k = \frac{\ln(1/2)}{704} \approx -0.0010$
 • $A(t) = e^{-0.0010t}$
 • $t = \frac{\ln(0.1)}{-0.0010} \approx 2302.58$ million years, or 2.30 billion years.
19. $t = \frac{\ln(0.1)}{k} = -\frac{\ln(10)}{k}$
20. $V(t) = 25e^{\ln(\frac{4}{5})t} \approx 25e^{-0.22314355t}$
21. (a) $G(0) = 9743.77$ This means that the GDP of the US in 2000 was \$9743.77 billion dollars.
 (b) $G(7) = 13963.24$ and $G(10) = 16291.25$, so the model predicted a GDP of \$13,963.24 billion in 2007 and \$16,291.25 billion in 2010.
22. (a) $D(0) = 15$, so the tumor was 15 millimeters in diameter when it was first detected.
 (b) $t = \frac{\ln(2)}{0.0277} \approx 25$ days.
23. (a) $k = \frac{\ln(2)}{20} \approx 0.0346$
 (b) $N(t) = 1000e^{0.0346t}$
 (c) $t = \frac{\ln(9)}{0.0346} \approx 63$ minutes
24. (a) $k = \frac{1}{2} \frac{\ln(6)}{2.5} \approx 0.4377$
 (b) $N(t) = 2.5e^{0.4377t}$
 (c) $t = \frac{\ln(2)}{0.4377} \approx 1.58$ hours
25. $N_0 = 52$, $k = \frac{1}{3} \ln\left(\frac{118}{52}\right) \approx 0.2731$, $N(t) = 52e^{0.2731t}$. $N(6) \approx 268$.
26. $N_0 = 2649$, $k = \frac{1}{60} \ln\left(\frac{7272}{2649}\right) \approx 0.0168$, $N(t) = 2649e^{0.0168t}$. $N(150) \approx 32923$, so the population of Painesville in 2010 based on this model would have been 32,923.
27. (a) $P(0) = \frac{120}{4.167} \approx 29$. There are 29 Sasquatch in Bigfoot County in 2010.
 (b) $P(3) = \frac{120}{1+3.167e^{-0.05(3)}} \approx 32$ Sasquatch.
 (c) $t = 20 \ln(3.167) \approx 23$ years.
 (d) As $t \rightarrow \infty$, $P(t) \rightarrow 120$. As time goes by, the Sasquatch Population in Bigfoot County will approach 120. Graphically, $y = P(x)$ has a horizontal asymptote $y = 120$.
28. (a) $A(t) = Ne^{-\left(\frac{\ln(2)}{5730}\right)t} \approx Ne^{-0.00012097t}$
 (b) $A(20000) \approx 0.088978 \cdot N$ so about 8.9% remains
 (c) $t \approx \frac{\ln(.42)}{-0.00012097} \approx 7171$ years old
29. $A(t) = 2.3e^{-0.0138629t}$

31. (a) $T(t) = 75 + 105e^{-0.005005t}$
 (b) The roast would have cooled to 140°F in about 95 minutes.
32. From the graph, it appears that as $x \rightarrow 0^+$, $y \rightarrow \infty$. This is due to the presence of the $\ln(x)$ term in the function. This means that Fritzy will never catch Chewbacca, which makes sense since Chewbacca has a head start and Fritzy only runs as fast as he does.

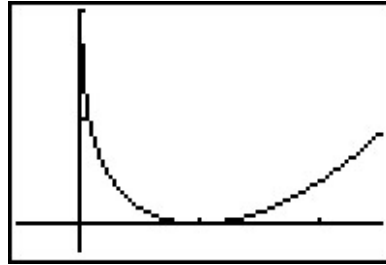

$$y(x) = \frac{1}{4}x^2 - \frac{1}{4}\ln(x) - \frac{1}{4}$$

33. The steady state current is 2 amps.
36. The linear regression on the data below is $y = 1.74899x + 0.70739$ with $r^2 \approx 0.999995$. This is an excellent fit.

x	1	2	3	4	5	6	7	8	9	10
$\ln(N(x))$	2.4849	4.1897	5.9454	7.6967	9.4478	11.1988	12.9497	14.7006	16.4523	18.2025

$N(x) = 2.02869(5.74879)^x = 2.02869e^{1.74899x}$ with $r^2 \approx 0.999995$. This is also an excellent fit and corresponds to our linearized model because $\ln(2.02869) \approx 0.70739$.

37. (a) The calculator gives: $y = 2895.06(1.0147)^x$. Graphing this along with our answer from Exercise 26 over the interval $[0, 60]$ shows that they are pretty close. From this model, $y(150) \approx 25840$ which once again overshoots the actual data value.
- (b) $P(150) \approx 18717$, so this model predicts 17,914 people in Painesville in 2010, a more conservative number than was recorded in the 2010 census. As $t \rightarrow \infty$, $P(t) \rightarrow 18691$. So the limiting population of Painesville based on this model is 18,691 people.

38. (a) $y = \frac{242526}{1 + 874.62e^{-0.07113x}}$, where x is the number of years since 1860.

- (b) The plot of the data and the curve is below.

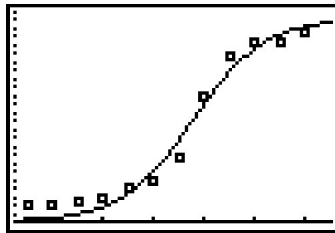

- (c) $y(140) \approx 232889$, so this model predicts 232,889 people in Lake County in 2010.
- (d) As $x \rightarrow \infty$, $y \rightarrow 242526$, so the limiting population of Lake County based on this model is 242,526 people.

CHAPTER 7

SYSTEMS OF EQUATIONS AND MATRICES

7.1 SYSTEMS OF LINEAR EQUATIONS: GAUSSIAN ELIMINATION

Up until now, when we concerned ourselves with solving different types of equations there was only one equation to solve at a time. Given an equation $f(x) = g(x)$, we could check our solutions geometrically by finding where the graphs of $y = f(x)$ and $y = g(x)$ intersect. The x -coordinates of these intersection points correspond to the solutions to the equation $f(x) = g(x)$, and the y -coordinates were largely ignored. If we modify the problem and ask for the intersection points of the graphs of $y = f(x)$ and $y = g(x)$, where both the solution to x and y are of interest, we have what is known as a **system of equations**, usually written as

$$\begin{cases} y = f(x) \\ y = g(x) \end{cases}$$

The ‘curly bracket’ notation means we are to find all **pairs** of points (x, y) which satisfy **both** equations. We begin our study of systems of equations by reviewing some basic notions from Intermediate Algebra.

Definition 7.1. A **linear equation in two variables** is an equation of the form $a_1x + a_2y = c$ where a_1 , a_2 and c are real numbers and at least one of a_1 and a_2 is nonzero.

For reasons which will become clear later in the section, we are using subscripts in Definition 7.1 to indicate different, but fixed, real numbers and those subscripts have no mathematical meaning beyond that. For example, $3x - \frac{y}{2} = 0.1$ is a linear equation in two variables with $a_1 = 3$, $a_2 = -\frac{1}{2}$ and $c = 0.1$. We can also consider $x = 5$ to be a linear equation in two variables¹ by identifying $a_1 = 1$, $a_2 = 0$, and $c = 5$. If a_1 and a_2 are both 0, then depending on c , we get either an equation which is *always* true, called an **identity**, or an equation which is *never* true, called a **contradiction**. (If $c = 0$, then we get $0 = 0$, which is always true. If $c \neq 0$, then we’d have $0 \neq 0$, which is never true.) Even though identities and contradictions have a large role to play

¹Critics may argue that $x = 5$ is clearly an equation in one variable. It can also be considered an equation in 117 variables with the coefficients of 116 variables set to 0. As with many conventions in Mathematics, the context will clarify the situation.

in the upcoming sections, we do not consider them linear equations. The key to identifying linear equations is to note that the variables involved are to the first power and that the coefficients of the variables are numbers. Some examples of equations which are non-linear are $x^2 + y = 1$, $xy = 5$ and $e^{2x} + \ln(y) = 1$. We leave it to the reader to explain why these do not satisfy Definition 7.1. From what we know from Sections 1.2 and 2.1, the graphs of linear equations are lines. If we couple two or more linear equations together, in effect to find the points of intersection of two or more lines, we obtain a **system of linear equations in two variables**. Our first example reviews some of the basic techniques first learned in Intermediate Algebra.

Example 7.1.1. Solve the following systems of equations. Check your answer algebraically and graphically.

$$1. \begin{cases} 2x - y = 1 \\ y = 3 \end{cases}$$

$$2. \begin{cases} 3x + 4y = -2 \\ -3x - y = 5 \end{cases}$$

$$3. \begin{cases} \frac{x}{3} - \frac{4y}{5} = \frac{7}{5} \\ \frac{2x}{9} + \frac{y}{3} = \frac{1}{2} \end{cases}$$

$$4. \begin{cases} 2x - 4y = 6 \\ 3x - 6y = 9 \end{cases}$$

$$5. \begin{cases} 6x + 3y = 9 \\ 4x + 2y = 12 \end{cases}$$

$$6. \begin{cases} x - y = 0 \\ x + y = 2 \\ -2x + y = -2 \end{cases}$$

Solution.

1. Our first system is nearly solved for us. The second equation tells us that $y = 3$. To find the corresponding value of x , we **substitute** this value for y into the the first equation to obtain $2x - 3 = 1$, so that $x = 2$. Our solution to the system is $(2, 3)$. To check this algebraically, we substitute $x = 2$ and $y = 3$ into each equation and see that they are satisfied. We see $2(2) - 3 = 1$, and $3 = 3$, as required. To check our answer graphically, we graph the lines $2x - y = 1$ and $y = 3$ and verify that they intersect at $(2, 3)$.
2. To solve the second system, we use the **addition** method to **eliminate** the variable x . We take the two equations as given and ‘add equals to equals’ to obtain

$$\begin{array}{r} 3x + 4y = -2 \\ + (-3x - y = 5) \\ \hline 3y = 3 \end{array}$$

This gives us $y = 1$. We now substitute $y = 1$ into either of the two equations, say $-3x - y = 5$, to get $-3x - 1 = 5$ so that $x = -2$. Our solution is $(-2, 1)$. Substituting $x = -2$ and $y = 1$ into the first equation gives $3(-2) + 4(1) = -2$, which is true, and, likewise, when we check $(-2, 1)$ in the second equation, we get $-3(-2) - 1 = 5$, which is also true. Geometrically, the lines $3x + 4y = -2$ and $-3x - y = 5$ intersect at $(-2, 1)$.

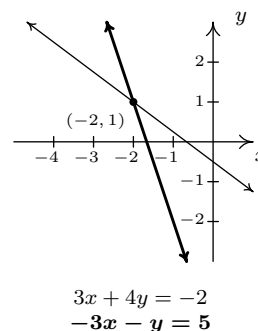
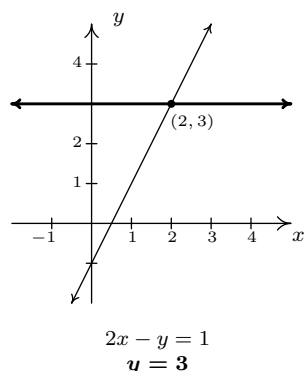

3. The equations in the third system are more approachable if we clear denominators. We multiply both sides of the first equation by 15 and both sides of the second equation by 18 to obtain the kinder, gentler system

$$\begin{cases} 5x - 12y = 21 \\ 4x + 6y = 9 \end{cases}$$

Adding these two equations directly fails to eliminate either of the variables, but we note that if we multiply the first equation by 4 and the second by -5 , we will be in a position to eliminate the x term

$$\begin{array}{r} 20x - 48y = 84 \\ + \quad (-20x - 30y = -45) \\ \hline -78y = 39 \end{array}$$

From this we get $y = -\frac{1}{2}$. We can temporarily avoid too much unpleasantness by choosing to substitute $y = -\frac{1}{2}$ into one of the equivalent equations we found by clearing denominators, say into $5x - 12y = 21$. We get $5x + 6 = 21$ which gives $x = 3$. Our answer is $(3, -\frac{1}{2})$. At this point, we have no choice – in order to check an answer algebraically, we must see if the answer satisfies both of the *original* equations, so we substitute $x = 3$ and $y = -\frac{1}{2}$ into both $\frac{x}{3} - \frac{4y}{5} = \frac{7}{5}$ and $\frac{2x}{9} + \frac{y}{3} = \frac{1}{2}$. We leave it to the reader to verify that the solution is correct. Graphing both of the lines involved with considerable care yields an intersection point of $(3, -\frac{1}{2})$.

4. An eerie calm settles over us as we cautiously approach our fourth system. Do its friendly integer coefficients belie something more sinister? We note that if we multiply both sides of the first equation by 3 and both sides of the second equation by -2 , we are ready to eliminate the x

$$\begin{array}{r}
 6x - 12y = 18 \\
 + \quad (-6x + 12y = -18) \\
 \hline
 0 = 0
 \end{array}$$

We eliminated not only the x , but the y as well and we are left with the identity $0 = 0$. This means that these two different linear equations are, in fact, equivalent. In other words, if an ordered pair (x, y) satisfies the equation $2x - 4y = 6$, it *automatically* satisfies the equation $3x - 6y = 9$. One way to describe the solution set to this system is to use the roster method² and write $\{(x, y) \mid 2x - 4y = 6\}$. While this is correct (and corresponds exactly to what's happening graphically, as we shall see shortly), we take this opportunity to introduce the notion of a **parametric solution to a system**. Our first step is to solve $2x - 4y = 6$ for one of the variables, say $y = \frac{1}{2}x - \frac{3}{2}$. For each value of x , the formula $y = \frac{1}{2}x - \frac{3}{2}$ determines the corresponding y -value of a solution. Since we have no restriction on x , it is called a **free variable**. We let $x = t$, a so-called 'parameter', and get $y = \frac{1}{2}t - \frac{3}{2}$. Our set of solutions can then be described as $\{(t, \frac{1}{2}t - \frac{3}{2}) \mid -\infty < t < \infty\}$.³ For specific values of t , we can generate solutions. For example, $t = 0$ gives us the solution $(0, -\frac{3}{2})$; $t = 117$ gives us $(117, 57)$, and while we can readily check each of these particular solutions satisfy both equations, the question is how do we check our general answer algebraically? Same as always. We claim that for any real number t , the pair $(t, \frac{1}{2}t - \frac{3}{2})$ satisfies both equations. Substituting $x = t$ and $y = \frac{1}{2}t - \frac{3}{2}$ into $2x - 4y = 6$ gives $2t - 4(\frac{1}{2}t - \frac{3}{2}) = 6$. Simplifying, we get $2t - 2t + 6 = 6$, which is always true. Similarly, when we make these substitutions in the equation $3x - 6y = 9$, we get $3t - 6(\frac{1}{2}t - \frac{3}{2}) = 9$ which reduces to $3t - 3t + 9 = 9$, so it checks out, too. Geometrically, $2x - 4y = 6$ and $3x - 6y = 9$ are the same line, which means that they intersect at every point on their graphs. The reader is encouraged to think about how our parametric solution says exactly that.

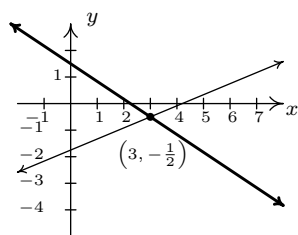

$$\begin{array}{l}
 \frac{x}{3} - \frac{4y}{5} = \frac{7}{5} \\
 \frac{2x}{9} + \frac{y}{3} = \frac{1}{2}
 \end{array}$$

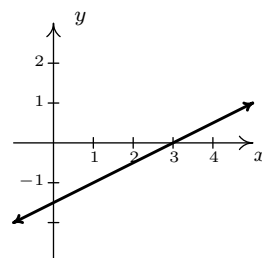

$$\begin{array}{l}
 2x - 4y = 6 \\
 3x - 6y = 9 \\
 \text{(Same line.)}
 \end{array}$$

²See Section 1.2 for a review of this.

³Note that we could have just as easily chosen to solve $2x - 4y = 6$ for x to obtain $x = 2y + 3$. Letting y be the parameter t , we have that for any value of t , $x = 2t + 3$, which gives $\{(2t + 3, t) \mid -\infty < t < \infty\}$. There is no one correct way to parameterize the solution set, which is why it is always best to check your answer.

5. Multiplying both sides of the first equation by 2 and the both sides of the second equation by -3 , we set the stage to eliminate x

$$\begin{array}{r} 12x + 6y = 18 \\ + \quad (-12x - 6y = -36) \\ \hline 0 = -18 \end{array}$$

As in the previous example, both x and y dropped out of the equation, but we are left with an irrevocable contradiction, $0 = -18$. This tells us that it is impossible to find a pair (x, y) which satisfies both equations; in other words, the system has no solution. Graphically, the lines $6x + 3y = 9$ and $4x + 2y = 12$ are distinct and parallel, so they do not intersect.

6. We can begin to solve our last system by adding the first two equations

$$\begin{array}{r} x - y = 0 \\ + \quad (x + y = 2) \\ \hline 2x = 2 \end{array}$$

which gives $x = 1$. Substituting this into the first equation gives $1 - y = 0$ so that $y = 1$. We seem to have determined a solution to our system, $(1, 1)$. While this checks in the first two equations, when we substitute $x = 1$ and $y = 1$ into the third equation, we get $-2(1) + (1) = -2$ which simplifies to the contradiction $-1 = -2$. Graphing the lines $x - y = 0$, $x + y = 2$, and $-2x + y = -2$, we see that the first two lines do, in fact, intersect at $(1, 1)$, however, all three lines never intersect at the same point simultaneously, which is what is required if a solution to the system is to be found.

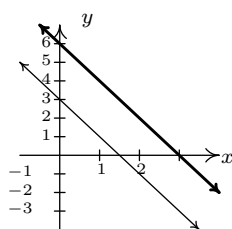

$$\begin{array}{l} 6x + 3y = 9 \\ 4x + 2y = 12 \end{array}$$

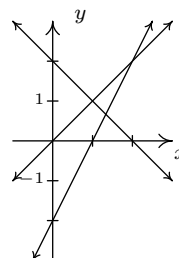

$$\begin{array}{l} y - x = 0 \\ y + x = 2 \\ -2x + y = -2 \end{array}$$

□

A few remarks about Example 7.1.1 are in order. It is clear that some systems of equations have solutions, and some do not. Those which have solutions are called **consistent**, those with no solution are called **inconsistent**. We also distinguish the two different types of behavior among

consistent systems. Those which admit free variables are called **dependent**; those with no free variables are called **independent**.⁴ Using this new vocabulary, we classify numbers 1, 2 and 3 in Example 7.1.1 as consistent independent systems, number 4 is consistent dependent, and numbers 5 and 6 are inconsistent.⁵ The system in 6 above is called **overdetermined**, since we have more equations than variables.⁶ Not surprisingly, a system with more variables than equations is called **underdetermined**. While the system in number 6 above is overdetermined and inconsistent, there exist overdetermined consistent systems (both dependent and independent) and we leave it to the reader to think about what is happening algebraically and geometrically in these cases. Likewise, there are both consistent and inconsistent underdetermined systems,⁷ but a consistent underdetermined system of linear equations is necessarily dependent.⁸

In order to move this section beyond a review of Intermediate Algebra, we now define what is meant by a linear equation in n variables.

Definition 7.2. A linear equation in n variables, x_1, x_2, \dots, x_n , is an equation of the form $a_1x_1 + a_2x_2 + \dots + a_nx_n = c$ where a_1, a_2, \dots, a_n and c are real numbers and at least one of a_1, a_2, \dots, a_n is nonzero.

Instead of using more familiar variables like x, y , and even z and/or w in Definition 7.2, we use subscripts to distinguish the different variables. We have no idea how many variables may be involved, so we use numbers to distinguish them instead of letters. (There is an endless supply of distinct numbers.) As an example, the linear equation $3x_1 - x_2 = 4$ represents the same relationship between the variables x_1 and x_2 as the equation $3x - y = 4$ does between the variables x and y . In addition, just as we cannot combine the terms in the expression $3x - y$, we cannot combine the terms in the expression $3x_1 - x_2$. Coupling more than one linear equation in n variables results in a **system of linear equations in n variables**. When solving these systems, it becomes increasingly important to keep track of what operations are performed to which equations and to develop a strategy based on the kind of manipulations we've already employed. To this end, we first remind ourselves of the maneuvers which can be applied to a system of linear equations that result in an equivalent system.⁹

⁴In the case of systems of linear equations, regardless of the number of equations or variables, consistent independent systems have exactly one solution. The reader is encouraged to think about why this is the case for linear equations in two variables. Hint: think geometrically.

⁵The adjectives 'dependent' and 'independent' apply only to *consistent* systems – they describe the *type* of solutions. Is there a free variable (dependent) or not (independent)?

⁶If we think of each variable being an unknown quantity, then ostensibly, to recover two unknown quantities, we need two pieces of information - i.e., two equations. Having more than two equations suggests we have more information than necessary to determine the values of the unknowns. While this is not necessarily the case, it does explain the choice of terminology 'overdetermined'.

⁷We need more than two variables to give an example of the latter.

⁸Again, experience with systems with more variables helps to see this here, as does a solid course in Linear Algebra.

⁹That is, a system with the same solution set.

Theorem 7.1. Given a system of equations, the following moves will result in an equivalent system of equations.

- Interchange the position of any two equations.
- Replace an equation with a nonzero multiple of itself.^a
- Replace an equation with itself plus a nonzero multiple of another equation.

^aThat is, an equation which results from multiplying both sides of the equation by the same nonzero number.

We have seen plenty of instances of the second and third moves in Theorem 7.1 when we solved the systems in Example 7.1.1. The first move, while it obviously admits an equivalent system, seems silly. Our perception will change as we consider more equations and more variables in this, and later sections.

Consider the system of equations

$$\begin{cases} x - \frac{1}{3}y + \frac{1}{2}z = 1 \\ y - \frac{1}{2}z = 4 \\ z = -1 \end{cases}$$

Clearly $z = -1$, and we substitute this into the second equation $y - \frac{1}{2}(-1) = 4$ to obtain $y = \frac{7}{2}$. Finally, we substitute $y = \frac{7}{2}$ and $z = -1$ into the first equation to get $x - \frac{1}{3}(\frac{7}{2}) + \frac{1}{2}(-1) = 1$, so that $x = \frac{8}{3}$. The reader can verify that these values of x , y and z satisfy all three original equations. It is tempting for us to write the solution to this system by extending the usual (x, y) notation to (x, y, z) and list our solution as $(\frac{8}{3}, \frac{7}{2}, -1)$. The question quickly becomes what does an ‘ordered triple’ like $(\frac{8}{3}, \frac{7}{2}, -1)$ represent? Just as ordered pairs are used to locate points on the two-dimensional plane, ordered triples can be used to locate points in space.¹⁰ Moreover, just as equations involving the variables x and y describe graphs of one-dimensional lines and curves in the two-dimensional plane, equations involving variables x , y , and z describe objects called **surfaces** in three-dimensional space. Each of the equations in the above system can be visualized as a plane situated in three-space. Geometrically, the system is trying to find the intersection, or common point, of all three planes. If you imagine three sheets of notebook paper each representing a portion of these planes, you will start to see the complexities involved in how three such planes can intersect. Below is a sketch of the three planes. It turns out that any two of these planes intersect in a line,¹¹ so our intersection point is where all three of these lines meet.

¹⁰You were asked to think about this in Exercise 40 in Section 1.1.

¹¹In fact, these lines are described by the parametric solutions to the systems formed by taking any two of these equations by themselves.

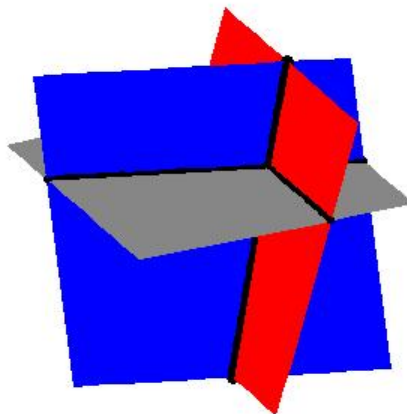

Since the geometry for equations involving more than two variables is complicated, we will focus our efforts on the algebra. Returning to the system

$$\begin{cases} x - \frac{1}{3}y + \frac{1}{2}z = 1 \\ y - \frac{1}{2}z = 4 \\ z = -1 \end{cases}$$

we note the reason it was so easy to solve is that the third equation is solved for z , the second equation involves only y and z , and since the coefficient of y is 1, it makes it easy to solve for y using our known value for z . Lastly, the coefficient of x in the first equation is 1 making it easy to substitute the known values of y and z and then solve for x . We formalize this pattern below for the most general systems of linear equations. Again, we use subscripted variables to describe the general case. The variable with the smallest subscript in a given equation is typically called the **leading variable** of that equation.

Definition 7.3. A system of linear equations with variables x_1, x_2, \dots, x_n is said to be in **triangular form** provided all of the following conditions hold:

1. The subscripts of the variables in each equation are always increasing from left to right.
2. The leading variable in each equation has coefficient 1.
3. The subscript on the leading variable in a given equation is greater than the subscript on the leading variable in the equation above it.
4. Any equation without variables^a cannot be placed above an equation with variables.

^anecessarily an identity or contradiction

In our previous system, if we make the obvious choices $x = x_1$, $y = x_2$, and $z = x_3$, we see that the system is in triangular form.¹² An example of a more complicated system in triangular form is

$$\begin{cases} x_1 - 4x_3 + x_4 - x_6 = 6 \\ x_2 + 2x_3 = 1 \\ x_4 + 3x_5 - x_6 = 8 \\ x_5 + 9x_6 = 10 \end{cases}$$

Our goal henceforth will be to transform a given system of linear equations into triangular form using the moves in Theorem 7.1.

Example 7.1.2. Use Theorem 7.1 to put the following systems into triangular form and then solve the system if possible. Classify each system as consistent independent, consistent dependent, or inconsistent.

$$1. \begin{cases} 3x - y + z = 3 \\ 2x - 4y + 3z = 16 \\ x - y + z = 5 \end{cases} \quad 2. \begin{cases} 2x + 3y - z = 1 \\ 10x - z = 2 \\ 4x - 9y + 2z = 5 \end{cases} \quad 3. \begin{cases} 3x_1 + x_2 + x_4 = 6 \\ 2x_1 + x_2 - x_3 = 4 \\ x_2 - 3x_3 - 2x_4 = 0 \end{cases}$$

Solution.

- For definitiveness, we label the topmost equation in the system $E1$, the equation beneath that $E2$, and so forth. We now attempt to put the system in triangular form using an algorithm known as **Gaussian Elimination**. What this means is that, starting with x , we transform the system so that conditions 2 and 3 in Definition 7.3 are satisfied. Then we move on to the next variable, in this case y , and repeat. Since the variables in all of the equations have a consistent ordering from left to right, our first move is to get an x in $E1$'s spot with a coefficient of 1. While there are many ways to do this, the easiest is to apply the first move listed in Theorem 7.1 and interchange $E1$ and $E3$.

$$\begin{cases} (E1) & 3x - y + z = 3 \\ (E2) & 2x - 4y + 3z = 16 \\ (E3) & x - y + z = 5 \end{cases} \xrightarrow{\text{Switch } E1 \text{ and } E3} \begin{cases} (E1) & x - y + z = 5 \\ (E2) & 2x - 4y + 3z = 16 \\ (E3) & 3x - y + z = 3 \end{cases}$$

To satisfy Definition 7.3, we need to eliminate the x 's from $E2$ and $E3$. We accomplish this by replacing each of them with a sum of themselves and a multiple of $E1$. To eliminate the x from $E2$, we need to multiply $E1$ by -2 then add; to eliminate the x from $E3$, we need to multiply $E1$ by -3 then add. Applying the third move listed in Theorem 7.1 twice, we get

$$\begin{cases} (E1) & x - y + z = 5 \\ (E2) & 2x - 4y + 3z = 16 \\ (E3) & 3x - y + z = 3 \end{cases} \xrightarrow{\begin{array}{l} \text{Replace } E2 \text{ with } -2E1 + E2 \\ \text{Replace } E3 \text{ with } -3E1 + E3 \end{array}} \begin{cases} (E1) & x - y + z = 5 \\ (E2) & -2y + z = 6 \\ (E3) & 2y - 2z = -12 \end{cases}$$

¹²If letters are used instead of subscripted variables, Definition 7.3 can be suitably modified using alphabetical order of the variables instead of numerical order on the subscripts of the variables.

Now we enforce the conditions stated in Definition 7.3 for the variable y . To that end we need to get the coefficient of y in $E2$ equal to 1. We apply the second move listed in Theorem 7.1 and replace $E2$ with itself times $-\frac{1}{2}$.

$$\left\{ \begin{array}{l} (E1) \quad x - y + z = 5 \\ (E2) \quad -2y + z = 6 \\ (E3) \quad 2y - 2z = -12 \end{array} \right. \xrightarrow{\text{Replace } E2 \text{ with } -\frac{1}{2}E2} \left\{ \begin{array}{l} (E1) \quad x - y + z = 5 \\ (E2) \quad y - \frac{1}{2}z = -3 \\ (E3) \quad 2y - 2z = -12 \end{array} \right.$$

To eliminate the y in $E3$, we add $-2E2$ to it.

$$\left\{ \begin{array}{l} (E1) \quad x - y + z = 5 \\ (E2) \quad y - \frac{1}{2}z = -3 \\ (E3) \quad 2y - 2z = -12 \end{array} \right. \xrightarrow{\text{Replace } E3 \text{ with } -2E2 + E3} \left\{ \begin{array}{l} (E1) \quad x - y + z = 5 \\ (E2) \quad y - \frac{1}{2}z = -3 \\ (E3) \quad -z = -6 \end{array} \right.$$

Finally, we apply the second move from Theorem 7.1 one last time and multiply $E3$ by -1 to satisfy the conditions of Definition 7.3 for the variable z .

$$\left\{ \begin{array}{l} (E1) \quad x - y + z = 5 \\ (E2) \quad y - \frac{1}{2}z = -3 \\ (E3) \quad -z = -6 \end{array} \right. \xrightarrow{\text{Replace } E3 \text{ with } -1E3} \left\{ \begin{array}{l} (E1) \quad x - y + z = 5 \\ (E2) \quad y - \frac{1}{2}z = -3 \\ (E3) \quad z = 6 \end{array} \right.$$

Now we proceed to substitute. Plugging in $z = 6$ into $E2$ gives $y - 3 = -3$ so that $y = 0$. With $y = 0$ and $z = 6$, $E1$ becomes $x - 0 + 6 = 5$, or $x = -1$. Our solution is $(-1, 0, 6)$. We leave it to the reader to check that substituting the respective values for x , y , and z into the original system results in three identities. Since we have found a solution, the system is consistent; since there are no free variables, it is independent.

- Proceeding as we did in 1, our first step is to get an equation with x in the $E1$ position with 1 as its coefficient. Since there is no easy fix, we multiply $E1$ by $\frac{1}{2}$.

$$\left\{ \begin{array}{l} (E1) \quad 2x + 3y - z = 1 \\ (E2) \quad 10x - z = 2 \\ (E3) \quad 4x - 9y + 2z = 5 \end{array} \right. \xrightarrow{\text{Replace } E1 \text{ with } \frac{1}{2}E1} \left\{ \begin{array}{l} (E1) \quad x + \frac{3}{2}y - \frac{1}{2}z = \frac{1}{2} \\ (E2) \quad 10x - z = 2 \\ (E3) \quad 4x - 9y + 2z = 5 \end{array} \right.$$

Now it's time to take care of the x 's in $E2$ and $E3$.

$$\left\{ \begin{array}{l} (E1) \quad x + \frac{3}{2}y - \frac{1}{2}z = \frac{1}{2} \\ (E2) \quad 10x - z = 2 \\ (E3) \quad 4x - 9y + 2z = 5 \end{array} \right. \xrightarrow{\begin{array}{l} \text{Replace } E2 \text{ with } -10E1 + E2 \\ \text{Replace } E3 \text{ with } -4E1 + E3 \end{array}} \left\{ \begin{array}{l} (E1) \quad x + \frac{3}{2}y - \frac{1}{2}z = \frac{1}{2} \\ (E2) \quad -15y + 4z = -3 \\ (E3) \quad -15y + 4z = 3 \end{array} \right.$$

Our next step is to get the coefficient of y in $E2$ equal to 1. To that end, we have

$$\left\{ \begin{array}{l} (E1) \quad x + \frac{3}{2}y - \frac{1}{2}z = \frac{1}{2} \\ (E2) \quad -15y + 4z = -3 \\ (E3) \quad -15y + 4z = 3 \end{array} \right. \xrightarrow{\text{Replace } E2 \text{ with } -\frac{1}{15}E2} \left\{ \begin{array}{l} (E1) \quad x + \frac{3}{2}y - \frac{1}{2}z = \frac{1}{2} \\ (E2) \quad y - \frac{4}{15}z = \frac{1}{5} \\ (E3) \quad -15y + 4z = 3 \end{array} \right.$$

Finally, we rid $E3$ of y .

$$\left\{ \begin{array}{l} (E1) \quad x + \frac{3}{2}y - \frac{1}{2}z = \frac{1}{2} \\ (E2) \quad y - \frac{4}{15}z = \frac{1}{5} \\ (E3) \quad -15y + 4z = 3 \end{array} \right. \xrightarrow{\text{Replace } E3 \text{ with } 15E2 + E3} \left\{ \begin{array}{l} (E1) \quad x - y + z = 5 \\ (E2) \quad y - \frac{1}{2}z = -3 \\ (E3) \quad 0 = 6 \end{array} \right.$$

The last equation, $0 = 6$, is a contradiction so the system has no solution. According to Theorem 7.1, since this system has no solutions, neither does the original, thus we have an inconsistent system.

3. For our last system, we begin by multiplying $E1$ by $\frac{1}{3}$ to get a coefficient of 1 on x_1 .

$$\left\{ \begin{array}{l} (E1) \quad 3x_1 + x_2 + x_4 = 6 \\ (E2) \quad 2x_1 + x_2 - x_3 = 4 \\ (E3) \quad x_2 - 3x_3 - 2x_4 = 0 \end{array} \right. \xrightarrow{\text{Replace } E1 \text{ with } \frac{1}{3}E1} \left\{ \begin{array}{l} (E1) \quad x_1 + \frac{1}{3}x_2 + \frac{1}{3}x_4 = 2 \\ (E2) \quad 2x_1 + x_2 - x_3 = 4 \\ (E3) \quad x_2 - 3x_3 - 2x_4 = 0 \end{array} \right.$$

Next we eliminate x_1 from $E2$

$$\left\{ \begin{array}{l} (E1) \quad x_1 + \frac{1}{3}x_2 + \frac{1}{3}x_4 = 2 \\ (E2) \quad 2x_1 + x_2 - x_3 = 4 \\ (E3) \quad x_2 - 3x_3 - 2x_4 = 0 \end{array} \right. \xrightarrow[\text{with } -2E1 + E2]{\text{Replace } E2} \left\{ \begin{array}{l} (E1) \quad x_1 + \frac{1}{3}x_2 + \frac{1}{3}x_4 = 2 \\ (E2) \quad \frac{1}{3}x_2 - x_3 - \frac{2}{3}x_4 = 0 \\ (E3) \quad x_2 - 3x_3 - 2x_4 = 0 \end{array} \right.$$

We switch $E2$ and $E3$ to get a coefficient of 1 for x_2 .

$$\left\{ \begin{array}{l} (E1) \quad x_1 + \frac{1}{3}x_2 + \frac{1}{3}x_4 = 2 \\ (E2) \quad \frac{1}{3}x_2 - x_3 - \frac{2}{3}x_4 = 0 \\ (E3) \quad x_2 - 3x_3 - 2x_4 = 0 \end{array} \right. \xrightarrow{\text{Switch } E2 \text{ and } E3} \left\{ \begin{array}{l} (E1) \quad x_1 + \frac{1}{3}x_2 + \frac{1}{3}x_4 = 2 \\ (E2) \quad x_2 - 3x_3 - 2x_4 = 0 \\ (E3) \quad \frac{1}{3}x_2 - x_3 - \frac{2}{3}x_4 = 0 \end{array} \right.$$

Finally, we eliminate x_2 in $E3$.

$$\left\{ \begin{array}{l} (E1) \quad x_1 + \frac{1}{3}x_2 + \frac{1}{3}x_4 = 2 \\ (E2) \quad x_2 - 3x_3 - 2x_4 = 0 \\ (E3) \quad \frac{1}{3}x_2 - x_3 - \frac{2}{3}x_4 = 0 \end{array} \right. \xrightarrow[\text{with } -\frac{1}{3}E2 + E3]{\text{Replace } E3} \left\{ \begin{array}{l} (E1) \quad x_1 + \frac{1}{3}x_2 + \frac{1}{3}x_4 = 2 \\ (E2) \quad x_2 - 3x_3 - 2x_4 = 0 \\ (E3) \quad 0 = 0 \end{array} \right.$$

Equation $E3$ reduces to $0 = 0$, which is always true. Since we have no equations with x_3 or x_4 as leading variables, they are both free, which means we have a consistent dependent system. We parametrize the solution set by letting $x_3 = s$ and $x_4 = t$ and obtain from $E2$ that $x_2 = 3s + 2t$. Substituting this and $x_4 = t$ into $E1$, we have $x_1 + \frac{1}{3}(3s + 2t) + \frac{1}{3}t = 2$ which gives $x_1 = 2 - s - t$. Our solution is the set $\{(2 - s - t, 2s + 3t, s, t) \mid -\infty < s, t < \infty\}$.¹³ We leave it to the reader to verify that the substitutions $x_1 = 2 - s - t$, $x_2 = 3s + 2t$, $x_3 = s$ and $x_4 = t$ satisfy the equations in the original system. \square

Like all algorithms, Gaussian Elimination has the advantage of always producing what we need, but it can also be inefficient at times. For example, when solving 2 above, it is clear after we eliminated the x 's in the second step to get the system

$$\left\{ \begin{array}{l} (E1) \quad x + \frac{3}{2}y - \frac{1}{2}z = \frac{1}{2} \\ (E2) \quad -15y + 4z = -3 \\ (E3) \quad -15y + 4z = 3 \end{array} \right.$$

that equations $E2$ and $E3$ when taken together form a contradiction since we have identical left hand sides and different right hand sides. The algorithm takes two more steps to reach this contradiction. We also note that substitution in Gaussian Elimination is delayed until all the elimination is done, thus it gets called **back-substitution**. This may also be inefficient in many cases. Rest assured, the technique of substitution as you may have learned it in Intermediate Algebra will once again take center stage in Section 7.2. Lastly, we note that the system in 3 above is underdetermined, and as it is consistent, we have free variables in our answer. We close this section with a standard 'mixture' type application of systems of linear equations.

Example 7.1.3. Lucas needs to create a 500 milliliters (mL) of a 40% acid solution. He has stock solutions of 30% and 90% acid as well as all of the distilled water he wants. Set-up and solve a system of linear equations which determines all of the possible combinations of the stock solutions and water which would produce the required solution.

Solution. We are after three unknowns, the amount (in mL) of the 30% stock solution (which we'll call x), the amount (in mL) of the 90% stock solution (which we'll call y) and the amount (in mL) of water (which we'll call w). We now need to determine some relationships between these variables. Our goal is to produce 500 milliliters of a 40% acid solution. This product has two defining characteristics. First, it must be 500 mL; second, it must be 40% acid. We take each

¹³Here, any choice of s and t will determine a solution which is a point in 4-dimensional space. Yeah, we have trouble visualizing that, too.

of these qualities in turn. First, the total volume of 500 mL must be the sum of the contributed volumes of the two stock solutions and the water. That is

$$\text{amount of 30\% stock solution} + \text{amount of 90\% stock solution} + \text{amount of water} = 500 \text{ mL}$$

Using our defined variables, this reduces to $x + y + w = 500$. Next, we need to make sure the final solution is 40% acid. Since water contains no acid, the acid will come from the stock solutions only. We find 40% of 500 mL to be 200 mL which means the final solution must contain 200 mL of acid. We have

$$\text{amount of acid in 30\% stock solution} + \text{amount of acid 90\% stock solution} = 200 \text{ mL}$$

The amount of acid in x mL of 30% stock is $0.30x$ and the amount of acid in y mL of 90% solution is $0.90y$. We have $0.30x + 0.90y = 200$. Converting to fractions,¹⁴ our system of equations becomes

$$\begin{cases} x + y + w = 500 \\ \frac{3}{10}x + \frac{9}{10}y = 200 \end{cases}$$

We first eliminate the x from the second equation

$$\begin{cases} (E1) & x + y + w = 500 \\ (E2) & \frac{3}{10}x + \frac{9}{10}y = 200 \end{cases} \xrightarrow{\text{Replace } E2 \text{ with } -\frac{3}{10}E1 + E2} \begin{cases} (E1) & x + y + w = 500 \\ (E2) & \frac{3}{5}y - \frac{3}{10}w = 50 \end{cases}$$

Next, we get a coefficient of 1 on the leading variable in $E2$

$$\begin{cases} (E1) & x + y + w = 500 \\ (E2) & \frac{3}{5}y - \frac{3}{10}w = 50 \end{cases} \xrightarrow{\text{Replace } E2 \text{ with } \frac{5}{3}E2} \begin{cases} (E1) & x + y + w = 500 \\ (E2) & y - \frac{1}{2}w = \frac{250}{3} \end{cases}$$

Notice that we have no equation to determine w , and as such, w is free. We set $w = t$ and from $E2$ get $y = \frac{1}{2}t + \frac{250}{3}$. Substituting into $E1$ gives $x + (\frac{1}{2}t + \frac{250}{3}) + t = 500$ so that $x = -\frac{3}{2}t + \frac{1250}{3}$. This system is consistent, dependent and its solution set is $\{(-\frac{3}{2}t + \frac{1250}{3}, \frac{1}{2}t + \frac{250}{3}, t) \mid -\infty < t < \infty\}$. While this answer checks algebraically, we have neglected to take into account that x , y and w , being amounts of acid and water, need to be nonnegative. That is, $x \geq 0$, $y \geq 0$ and $w \geq 0$. The constraint $x \geq 0$ gives us $-\frac{3}{2}t + \frac{1250}{3} \geq 0$, or $t \leq \frac{2500}{9}$. From $y \geq 0$, we get $\frac{1}{2}t + \frac{250}{3} \geq 0$ or $t \geq -\frac{500}{3}$. The condition $z \geq 0$ yields $t \geq 0$, and we see that when we take the set theoretic intersection of these intervals, we get $0 \leq t \leq \frac{2500}{9}$. Our final answer is $\{(-\frac{3}{2}t + \frac{1250}{3}, \frac{1}{2}t + \frac{250}{3}, t) \mid 0 \leq t \leq \frac{2500}{9}\}$. Of what practical use is our answer? Suppose there is only 100 mL of the 90% solution remaining and it is due to expire. Can we use all of it to make our required solution? We would have $y = 100$ so that $\frac{1}{2}t + \frac{250}{3} = 100$, and we get $t = \frac{100}{3}$. This means the amount of 30% solution required is $x = -\frac{3}{2}t + \frac{1250}{3} = -\frac{3}{2}(\frac{100}{3}) + \frac{1250}{3} = \frac{1100}{3}$ mL, and for the water, $w = t = \frac{100}{3}$ mL. The reader is invited to check that mixing these three amounts of our constituent solutions produces the required 40% acid mix. \square

¹⁴We do this only because we believe students can use all of the practice with fractions they can get!

7.1.1 EXERCISES

(Review Exercises) In Exercises 1 - 8, take a trip down memory lane and solve the given system using substitution and/or elimination. Classify each system as consistent independent, consistent dependent, or inconsistent. Check your answers both algebraically and graphically.

1.
$$\begin{cases} x + 2y = 5 \\ x = 6 \end{cases}$$

2.
$$\begin{cases} 2y - 3x = 1 \\ y = -3 \end{cases}$$

3.
$$\begin{cases} \frac{x+2y}{4} = -5 \\ \frac{3x-y}{2} = 1 \end{cases}$$

4.
$$\begin{cases} \frac{2}{3}x - \frac{1}{5}y = 3 \\ \frac{1}{2}x + \frac{3}{4}y = 1 \end{cases}$$

5.
$$\begin{cases} \frac{1}{2}x - \frac{1}{3}y = -1 \\ 2y - 3x = 6 \end{cases}$$

6.
$$\begin{cases} x + 4y = 6 \\ \frac{1}{12}x + \frac{1}{3}y = \frac{1}{2} \end{cases}$$

7.
$$\begin{cases} 3y - \frac{3}{2}x = -\frac{15}{2} \\ \frac{1}{2}x - y = \frac{3}{2} \end{cases}$$

8.
$$\begin{cases} \frac{5}{6}x + \frac{5}{3}y = -\frac{7}{3} \\ -\frac{10}{3}x - \frac{20}{3}y = 10 \end{cases}$$

In Exercises 9 - 26, put each system of linear equations into triangular form and solve the system if possible. Classify each system as consistent independent, consistent dependent, or inconsistent.

9.
$$\begin{cases} -5x + y = 17 \\ x + y = 5 \end{cases}$$

10.
$$\begin{cases} x + y + z = 3 \\ 2x - y + z = 0 \\ -3x + 5y + 7z = 7 \end{cases}$$

11.
$$\begin{cases} 4x - y + z = 5 \\ 2y + 6z = 30 \\ x + z = 5 \end{cases}$$

12.
$$\begin{cases} 4x - y + z = 5 \\ 2y + 6z = 30 \\ x + z = 6 \end{cases}$$

13.
$$\begin{cases} x + y + z = -17 \\ y - 3z = 0 \end{cases}$$

14.
$$\begin{cases} x - 2y + 3z = 7 \\ -3x + y + 2z = -5 \\ 2x + 2y + z = 3 \end{cases}$$

15.
$$\begin{cases} 3x - 2y + z = -5 \\ x + 3y - z = 12 \\ x + y + 2z = 0 \end{cases}$$

16.
$$\begin{cases} 2x - y + z = -1 \\ 4x + 3y + 5z = 1 \\ 5y + 3z = 4 \end{cases}$$

17.
$$\begin{cases} x - y + z = -4 \\ -3x + 2y + 4z = -5 \\ x - 5y + 2z = -18 \end{cases}$$

18.
$$\begin{cases} 2x - 4y + z = -7 \\ x - 2y + 2z = -2 \\ -x + 4y - 2z = 3 \end{cases}$$

19.
$$\begin{cases} 2x - y + z = 1 \\ 2x + 2y - z = 1 \\ 3x + 6y + 4z = 9 \end{cases}$$

20.
$$\begin{cases} x - 3y - 4z = 3 \\ 3x + 4y - z = 13 \\ 2x - 19y - 19z = 2 \end{cases}$$

$$21. \begin{cases} x + y + z = 4 \\ 2x - 4y - z = -1 \\ x - y = 2 \end{cases}$$

$$22. \begin{cases} x - y + z = 8 \\ 3x + 3y - 9z = -6 \\ 7x - 2y + 5z = 39 \end{cases}$$

$$23. \begin{cases} 2x - 3y + z = -1 \\ 4x - 4y + 4z = -13 \\ 6x - 5y + 7z = -25 \end{cases}$$

$$24. \begin{cases} 2x_1 + x_2 - 12x_3 - x_4 = 16 \\ -x_1 + x_2 + 12x_3 - 4x_4 = -5 \\ 3x_1 + 2x_2 - 16x_3 - 3x_4 = 25 \\ x_1 + 2x_2 - 5x_4 = 11 \end{cases}$$

$$25. \begin{cases} x_1 - x_3 = -2 \\ 2x_2 - x_4 = 0 \\ x_1 - 2x_2 + x_3 = 0 \\ -x_3 + x_4 = 1 \end{cases}$$

$$26. \begin{cases} x_1 - x_2 - 5x_3 + 3x_4 = -1 \\ x_1 + x_2 + 5x_3 - 3x_4 = 0 \\ x_2 + 5x_3 - 3x_4 = 1 \\ x_1 - 2x_2 - 10x_3 + 6x_4 = -1 \end{cases}$$

27. Find two other forms of the parametric solution to Exercise 11 above by reorganizing the equations so that x or y can be the free variable.
28. A local buffet charges \$7.50 per person for the basic buffet and \$9.25 for the deluxe buffet (which includes crab legs.) If 27 diners went out to eat and the total bill was \$227.00 before taxes, how many chose the basic buffet and how many chose the deluxe buffet?
29. At The Old Home Fill'er Up and Keep on a-Truckin' Cafe, Mavis mixes two different types of coffee beans to produce a house blend. The first type costs \$3 per pound and the second costs \$8 per pound. How much of each type does Mavis use to make 50 pounds of a blend which costs \$6 per pound?
30. Skippy has a total of \$10,000 to split between two investments. One account offers 3% simple interest, and the other account offers 8% simple interest. For tax reasons, he can only earn \$500 in interest the entire year. How much money should Skippy invest in each account to earn \$500 in interest for the year?
31. A 10% salt solution is to be mixed with pure water to produce 75 gallons of a 3% salt solution. How much of each are needed?
32. At The Crispy Critter's Head Shop and Patchouli Emporium along with their dried up weeds, sunflower seeds and astrological postcards they sell an herbal tea blend. By weight, Type I herbal tea is 30% peppermint, 40% rose hips and 30% chamomile, Type II has percents 40%, 20% and 40%, respectively, and Type III has percents 35%, 30% and 35%, respectively. How much of each Type of tea is needed to make 2 pounds of a new blend of tea that is equal parts peppermint, rose hips and chamomile?
33. Discuss with your classmates how you would approach Exercise 32 above if they needed to use up a pound of Type I tea to make room on the shelf for a new canister.
34. If you were to try to make 100 mL of a 60% acid solution using stock solutions at 20% and 40%, respectively, what would the triangular form of the resulting system look like? Explain.

7.1.2 ANSWERS

- | | |
|---|---|
| 1. Consistent independent
Solution $(6, -\frac{1}{2})$ | 2. Consistent independent
Solution $(-\frac{7}{3}, -3)$ |
| 3. Consistent independent
Solution $(-\frac{16}{7}, -\frac{62}{7})$ | 4. Consistent independent
Solution $(\frac{49}{12}, -\frac{25}{18})$ |
| 5. Consistent dependent
Solution $(t, \frac{3}{2}t + 3)$
for all real numbers t | 6. Consistent dependent
Solution $(6 - 4t, t)$
for all real numbers t |
| 7. Inconsistent
No solution | 8. Inconsistent
No solution |

Because triangular form is not unique, we give only one possible answer to that part of the question. Yours may be different and still be correct.

- | | |
|---|--|
| 9. $\begin{cases} x + y = 5 \\ y = 7 \end{cases}$ | Consistent independent
Solution $(-2, 7)$ |
| 10. $\begin{cases} x - \frac{5}{3}y - \frac{7}{3}z = -\frac{7}{3} \\ y + \frac{5}{4}z = 2 \\ z = 0 \end{cases}$ | Consistent independent
Solution $(1, 2, 0)$ |
| 11. $\begin{cases} x - \frac{1}{4}y + \frac{1}{4}z = \frac{5}{4} \\ y + 3z = 15 \\ 0 = 0 \end{cases}$ | Consistent dependent
Solution $(-t + 5, -3t + 15, t)$
for all real numbers t |
| 12. $\begin{cases} x - \frac{1}{4}y + \frac{1}{4}z = \frac{5}{4} \\ y + 3z = 15 \\ 0 = 1 \end{cases}$ | Inconsistent
No solution |
| 13. $\begin{cases} x + y + z = -17 \\ y - 3z = 0 \end{cases}$ | Consistent dependent
Solution $(-4t - 17, 3t, t)$
for all real numbers t |
| 14. $\begin{cases} x - 2y + 3z = 7 \\ y - \frac{11}{5}z = -\frac{16}{5} \\ z = 1 \end{cases}$ | Consistent independent
Solution $(2, -1, 1)$ |

15.
$$\begin{cases} x + y + 2z = 0 \\ y - \frac{3}{2}z = 6 \\ z = -2 \end{cases}$$
 Consistent independent
Solution $(1, 3, -2)$
16.
$$\begin{cases} x - \frac{1}{2}y + \frac{1}{2}z = -\frac{1}{2} \\ y + \frac{3}{5}z = \frac{3}{5} \\ 0 = 1 \end{cases}$$
 Inconsistent
no solution
17.
$$\begin{cases} x - y + z = -4 \\ y - 7z = 17 \\ z = -2 \end{cases}$$
 Consistent independent
Solution $(1, 3, -2)$
18.
$$\begin{cases} x - 2y + 2z = -2 \\ y = \frac{1}{2} \\ z = 1 \end{cases}$$
 Consistent independent
Solution $(-3, \frac{1}{2}, 1)$
19.
$$\begin{cases} x - \frac{1}{2}y + \frac{1}{2}z = \frac{1}{2} \\ y - \frac{2}{3}z = 0 \\ z = 1 \end{cases}$$
 Consistent independent
Solution $(\frac{1}{3}, \frac{2}{3}, 1)$
20.
$$\begin{cases} x - 3y - 4z = 3 \\ y + \frac{11}{13}z = \frac{4}{13} \\ 0 = 0 \end{cases}$$
 Consistent dependent
Solution $(\frac{19}{13}t + \frac{51}{13}, -\frac{11}{13}t + \frac{4}{13}, t)$
for all real numbers t
21.
$$\begin{cases} x + y + z = 4 \\ y + \frac{1}{2}z = \frac{3}{2} \\ 0 = 1 \end{cases}$$
 Inconsistent
no solution
22.
$$\begin{cases} x - y + z = 8 \\ y - 2z = -5 \\ z = 1 \end{cases}$$
 Consistent independent
Solution $(4, -3, 1)$
23.
$$\begin{cases} x - \frac{3}{2}y + \frac{1}{2}z = -\frac{1}{2} \\ y + z = -\frac{11}{2} \\ 0 = 0 \end{cases}$$
 Consistent dependent
Solution $(-2t - \frac{35}{4}, -t - \frac{11}{2}, t)$
for all real numbers t
24.
$$\begin{cases} x_1 + \frac{2}{3}x_2 - \frac{16}{3}x_3 - x_4 = \frac{25}{3} \\ x_2 + 4x_3 - 3x_4 = 2 \\ 0 = 0 \\ 0 = 0 \end{cases}$$
 Consistent dependent
Solution $(8s - t + 7, -4s + 3t + 2, s, t)$
for all real numbers s and t
25.
$$\begin{cases} x_1 - x_3 = -2 \\ x_2 - \frac{1}{2}x_4 = 0 \\ x_3 - \frac{1}{2}x_4 = 1 \\ x_4 = 4 \end{cases}$$
 Consistent independent
Solution $(1, 2, 3, 4)$

$$26. \begin{cases} x_1 - x_2 - 5x_3 + 3x_4 = -1 \\ x_2 + 5x_3 - 3x_4 = \frac{1}{2} \\ 0 = 1 \\ 0 = 0 \end{cases} \quad \begin{array}{l} \text{Inconsistent} \\ \text{No solution} \end{array}$$

27. If x is the free variable then the solution is $(t, 3t, -t + 5)$ and if y is the free variable then the solution is $(\frac{1}{3}t, t, -\frac{1}{3}t + 5)$.
28. 13 chose the basic buffet and 14 chose the deluxe buffet.
29. Mavis needs 20 pounds of \$3 per pound coffee and 30 pounds of \$8 per pound coffee.
30. Skippy needs to invest \$6000 in the 3% account and \$4000 in the 8% account.
31. 22.5 gallons of the 10% solution and 52.5 gallons of pure water.
32. $\frac{4}{3} - \frac{1}{2}t$ pounds of Type I, $\frac{2}{3} - \frac{1}{2}t$ pounds of Type II and t pounds of Type III where $0 \leq t \leq \frac{4}{3}$.

7.2 SYSTEMS OF NON-LINEAR EQUATIONS AND INEQUALITIES

In this section, we study systems of non-linear equations and inequalities. Unlike the systems of linear equations for which we have developed several algorithmic solution techniques, there is no general algorithm to solve systems of non-linear equations. Moreover, all of the usual hazards of non-linear equations like extraneous solutions and unusual function domains are once again present. Along with the tried and true techniques of substitution and elimination, we shall often need equal parts tenacity and ingenuity to see a problem through to the end. You may find it necessary to review topics throughout the text which pertain to solving equations involving the various functions we have studied thus far. To get the section rolling we begin with a fairly routine example.

Example 7.2.1. Solve the following systems of equations. Verify your answers algebraically and graphically.

$$1. \begin{cases} x^2 + y^2 = 4 \\ 4x^2 + 9y^2 = 36 \end{cases}$$

$$3. \begin{cases} x^2 + y^2 = 4 \\ y - 2x = 0 \end{cases}$$

$$2. \begin{cases} x^2 + y^2 = 4 \\ 4x^2 - 9y^2 = 36 \end{cases}$$

$$4. \begin{cases} x^2 + y^2 = 4 \\ y - x^2 = 0 \end{cases}$$

SOLUTION:

1. Since both equations contain x^2 and y^2 only, we can eliminate one of the variables as we did in Section 7.1.

$$\begin{cases} (E1) & x^2 + y^2 = 4 \\ (E2) & 4x^2 + 9y^2 = 36 \end{cases} \xrightarrow[-4E1 + E2]{\text{Replace } E2 \text{ with}} \begin{cases} (E1) & x^2 + y^2 = 4 \\ (E2) & 5y^2 = 20 \end{cases}$$

From $5y^2 = 20$, we get $y^2 = 4$ or $y = \pm 2$. To find the associated x values, we substitute each value of y into one of the equations to find the resulting value of x . Choosing $x^2 + y^2 = 4$, we find that for both $y = -2$ and $y = 2$, we get $x = 0$. Our solution is thus $\{(0, 2), (0, -2)\}$. To check this algebraically, we need to show that both points satisfy both of the original equations. We leave it to the reader to verify this. To check our answer graphically, we sketch both equations and look for their points of intersection. The graph of $x^2 + y^2 = 4$ is a circle centered at $(0, 0)$ with a radius of 2, whereas the graph of $4x^2 + 9y^2 = 36$, when written in the standard form $\frac{x^2}{9} + \frac{y^2}{4} = 1$ is easily recognized as an ellipse centered at $(0, 0)$ with a major axis along the x -axis of length 6 and a minor axis along the y -axis of length 4. We see from the graph that the two curves intersect at their y -intercepts only, $(0, \pm 2)$.

2. We proceed as before to eliminate one of the variables

$$\begin{cases} (E1) & x^2 + y^2 = 4 \\ (E2) & 4x^2 - 9y^2 = 36 \end{cases} \xrightarrow[-4E1 + E2]{\text{Replace } E2 \text{ with}} \begin{cases} (E1) & x^2 + y^2 = 4 \\ (E2) & -13y^2 = 20 \end{cases}$$

Since the equation $-13y^2 = 20$ admits no real solution, the system is inconsistent. To verify this graphically, we note that $x^2 + y^2 = 4$ is the same circle as before, but when writing the second equation in standard form, $\frac{x^2}{9} - \frac{y^2}{4} = 1$, we find a hyperbola centered at $(0,0)$ opening to the left and right with a transverse axis of length 6 and a conjugate axis of length 4. We see that the circle and the hyperbola have no points in common.

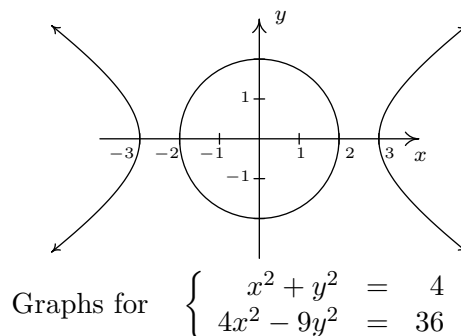
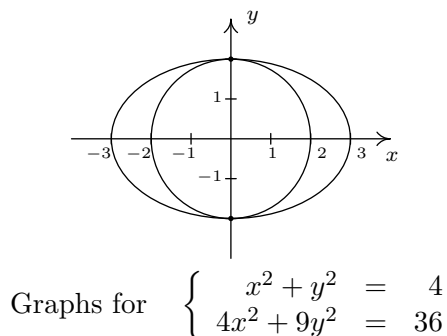

3. Since there are no like terms among the two equations, elimination won't do us any good. We turn to substitution and from the equation $y - 2x = 0$, we get $y = 2x$. Substituting this into $x^2 + y^2 = 4$ gives $x^2 + (2x)^2 = 4$. Solving, we find $5x^2 = 4$ or $x = \pm \frac{2\sqrt{5}}{5}$. Returning to the equation we used for the substitution, $y = 2x$, we find $y = \frac{4\sqrt{5}}{5}$ when $x = \frac{2\sqrt{5}}{5}$, so one solution is $(\frac{2\sqrt{5}}{5}, \frac{4\sqrt{5}}{5})$. Similarly, we find the other solution to be $(-\frac{2\sqrt{5}}{5}, -\frac{4\sqrt{5}}{5})$. We leave it to the reader that both points satisfy both equations, so that our final answer is $\left\{ \left(\frac{2\sqrt{5}}{5}, \frac{4\sqrt{5}}{5} \right), \left(-\frac{2\sqrt{5}}{5}, -\frac{4\sqrt{5}}{5} \right) \right\}$. The graph of $x^2 + y^2 = 4$ is our circle from before and the graph of $y - 2x = 0$ is a line through the origin with slope 2. Though we cannot verify the numerical values of the points of intersection from our sketch, we do see that we have two solutions: one in Quadrant I and one in Quadrant III as required.
4. While it may be tempting to solve $y - x^2 = 0$ as $y = x^2$ and substitute, we note that this system is set up for elimination.¹

$$\begin{cases} (E1) & x^2 + y^2 = 4 \\ (E2) & y - x^2 = 0 \end{cases} \xrightarrow[\text{E1 + E2}]{\text{Replace E2 with}} \begin{cases} (E1) & x^2 + y^2 = 4 \\ (E2) & y^2 + y = 4 \end{cases}$$

From $y^2 + y = 4$ we get $y^2 + y - 4 = 0$ which gives $y = \frac{-1 \pm \sqrt{17}}{2}$. Due to the complicated nature of these answers, it is worth our time to make a quick sketch of both equations to head off any extraneous solutions we may encounter. We see that the circle $x^2 + y^2 = 4$ intersects the parabola $y = x^2$ exactly twice, and both of these points have a positive y value. Of the two solutions for y , only $y = \frac{-1 + \sqrt{17}}{2}$ is positive, so to get our solution, we substitute this

¹We encourage the reader to solve the system using substitution to see that you get the same solution.

into $y - x^2 = 0$ and solve for x . We get $x = \pm\sqrt{\frac{-1+\sqrt{17}}{2}} = \pm\sqrt{\frac{-2+2\sqrt{17}}{2}}$. Our solution is $\left\{ \left(\frac{\sqrt{-2+2\sqrt{17}}}{2}, \frac{-1+\sqrt{17}}{2} \right), \left(-\frac{\sqrt{-2+2\sqrt{17}}}{2}, \frac{-1+\sqrt{17}}{2} \right) \right\}$, which we leave to the reader to verify.

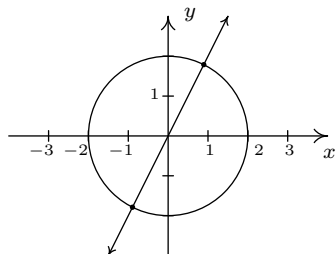

Graphs for $\begin{cases} x^2 + y^2 = 4 \\ y - 2x = 0 \end{cases}$

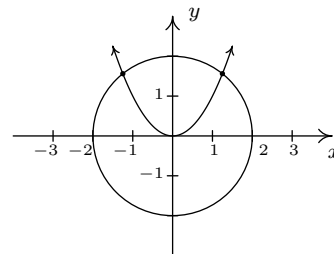

Graphs for $\begin{cases} x^2 + y^2 = 4 \\ y - x^2 = 36 \end{cases}$

□

A couple of remarks about Example 7.2.1 are in order. First note that, unlike systems of linear equations, it is possible for a system of non-linear equations to have more than one solution without having infinitely many solutions. In fact, while we characterize systems of nonlinear equations as being ‘consistent’ or ‘inconsistent,’ we generally don’t use the labels ‘dependent’ or ‘independent’. Secondly, as we saw with number 4, sometimes making a quick sketch of the problem situation can save a lot of time and effort. While in general the curves in a system of non-linear equations may not be easily visualized, it sometimes pays to take advantage when they are. Our next example provides some considerable review of many of the topics introduced in this text.

Example 7.2.2. Solve the following systems of equations. Verify your answers algebraically and graphically, as appropriate.

$$1. \begin{cases} x^2 + 2xy - 16 = 0 \\ y^2 + 2xy - 16 = 0 \end{cases} \quad 2. \begin{cases} y + 4e^{2x} = 1 \\ y^2 + 2e^x = 1 \end{cases} \quad 3. \begin{cases} z(x-2) = x \\ yz = y \\ (x-2)^2 + y^2 = 1 \end{cases}$$

Solution.

- At first glance, it doesn’t appear as though elimination will do us any good since it’s clear that we cannot completely eliminate one of the variables. The alternative, solving one of the equations for one variable and substituting it into the other, is full of unpleasantness. Returning to elimination, we note that it is possible to eliminate the troublesome xy term, and the constant term as well, by elimination and doing so we get a more tractable relationship between x and y

$$\begin{cases} (E1) & x^2 + 2xy - 16 = 0 \\ (E2) & y^2 + 2xy - 16 = 0 \end{cases} \xrightarrow[-E1 + E2]{\text{Replace } E2 \text{ with}} \begin{cases} (E1) & x^2 + 2xy - 16 = 0 \\ (E2) & y^2 - x^2 = 0 \end{cases}$$

We get $y^2 - x^2 = 0$ or $y = \pm x$. Substituting $y = x$ into $E1$ we get $x^2 + 2x^2 - 16 = 0$ so that $x^2 = \frac{16}{3}$ or $x = \pm \frac{4\sqrt{3}}{3}$. On the other hand, when we substitute $y = -x$ into $E1$, we get $x^2 - 2x^2 - 16 = 0$ or $x^2 = -16$ which gives no real solutions. Substituting each of $x = \pm \frac{4\sqrt{3}}{3}$ into the substitution equation $y = x$ yields the solution $\left\{ \left(\frac{4\sqrt{3}}{3}, \frac{4\sqrt{3}}{3} \right), \left(-\frac{4\sqrt{3}}{3}, -\frac{4\sqrt{3}}{3} \right) \right\}$. We leave it to the reader to show that both points satisfy both equations and now turn to verifying our solution graphically. We begin by solving $x^2 + 2xy - 16 = 0$ for y to obtain $y = \frac{16-x^2}{2x}$. This function is easily graphed using the techniques of Section 4.2. Solving the second equation, $y^2 + 2xy - 16 = 0$, for y , however, is more complicated. We use the quadratic formula to obtain $y = -x \pm \sqrt{x^2 + 16}$ which would require the use of Calculus or a calculator to graph. Believe it or not, we don't need either because the equation $y^2 + 2xy - 16 = 0$ can be obtained from the equation $x^2 + 2xy - 16 = 0$ by interchanging y and x . Thinking back to Section 5.2, this means we can obtain the graph of $y^2 + 2xy - 16 = 0$ by reflecting the graph of $x^2 + 2xy - 16 = 0$ across the line $y = x$. Doing so confirms that the two graphs intersect twice: once in Quadrant I, and once in Quadrant III as required.

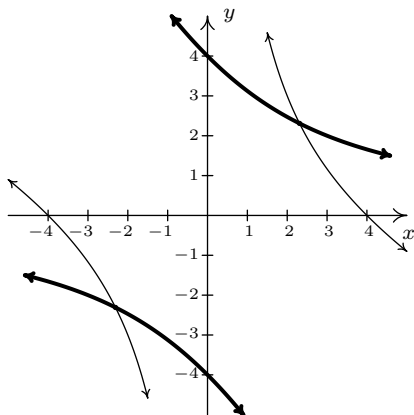

The graphs of $x^2 + 2xy - 16 = 0$ and $y^2 + 2xy - 16 = 0$

2. Unlike the previous problem, there seems to be no avoiding substitution and a bit of algebraic unpleasantness. Solving $y + 4e^{2x} = 1$ for y , we get $y = 1 - 4e^{2x}$ which, when substituted into the second equation, yields $(1 - 4e^{2x})^2 + 2e^x = 1$. After expanding and gathering like terms, we get $16e^{4x} - 8e^{2x} + 2e^x = 0$. Factoring gives us $2e^x(8e^{3x} - 4e^x + 1) = 0$, and since $2e^x \neq 0$ for any real x , we are left with solving $8e^{3x} - 4e^x + 1 = 0$. We have three terms, and even though this is not a 'quadratic in disguise', we can benefit from the substitution $u = e^x$. The equation becomes $8u^3 - 4u + 1 = 0$. Using the techniques set forth in Section 3.3, we find $u = \frac{1}{2}$ is a zero and use synthetic division to factor the left hand side as $(u - \frac{1}{2})(8u^2 + 4u - 2)$. We use the quadratic formula to solve $8u^2 + 4u - 2 = 0$ and find $u = \frac{-1 \pm \sqrt{5}}{4}$. Since $u = e^x$, we now must solve $e^x = \frac{1}{2}$ and $e^x = \frac{-1 \pm \sqrt{5}}{4}$. From $e^x = \frac{1}{2}$, we get $x = \ln(\frac{1}{2}) = -\ln(2)$. As for $e^x = \frac{-1 \pm \sqrt{5}}{4}$, we first note that $\frac{-1 - \sqrt{5}}{4} < 0$, so $e^x = \frac{-1 - \sqrt{5}}{4}$ has no real solutions. We are

left with $e^x = \frac{-1+\sqrt{5}}{4}$, so that $x = \ln\left(\frac{-1+\sqrt{5}}{4}\right)$. We now return to $y = 1 - 4e^{2x}$ to find the accompanying y values for each of our solutions for x . For $x = -\ln(2)$, we get

$$\begin{aligned} y &= 1 - 4e^{2x} \\ &= 1 - 4e^{-2\ln(2)} \\ &= 1 - 4e^{\ln\left(\frac{1}{4}\right)} \\ &= 1 - 4\left(\frac{1}{4}\right) \\ &= 0 \end{aligned}$$

For $x = \ln\left(\frac{-1+\sqrt{5}}{4}\right)$, we have

$$\begin{aligned} y &= 1 - 4e^{2x} \\ &= 1 - 4e^{2\ln\left(\frac{-1+\sqrt{5}}{4}\right)} \\ &= 1 - 4e^{\ln\left(\frac{-1+\sqrt{5}}{4}\right)^2} \\ &= 1 - 4\left(\frac{-1+\sqrt{5}}{4}\right)^2 \\ &= 1 - 4\left(\frac{3-\sqrt{5}}{8}\right) \\ &= \frac{-1+\sqrt{5}}{2} \end{aligned}$$

We get two solutions, $\left\{(0, -\ln(2)), \left(\ln\left(\frac{-1+\sqrt{5}}{4}\right), \frac{-1+\sqrt{5}}{2}\right)\right\}$. It is a good review of the properties of logarithms to verify both solutions, so we leave that to the reader. We are able to sketch $y = 1 - 4e^{2x}$ using transformations, but the second equation is more difficult and we resort to the calculator. We note that to graph $y^2 + 2e^x = 1$, we need to graph both the positive and negative roots, $y = \pm\sqrt{1 - 2e^x}$. After some careful zooming,² we get

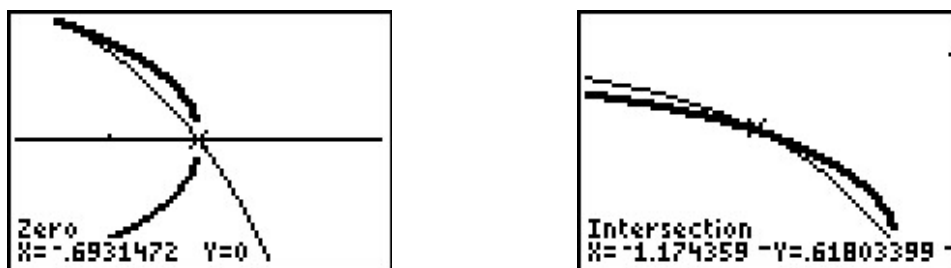

The graphs of $y = 1 - 4e^{2x}$ and $y = \pm\sqrt{1 - 2e^x}$.

- Our last system involves three variables and gives some insight on how to keep such systems organized. Labeling the equations as before, we have

²The calculator has trouble confirming the solution $(-\ln(2), 0)$ due to its issues in graphing square root functions. If we mentally connect the two branches of the thicker curve, we see the intersection.

$$\begin{cases} E1 & z(x-2) = x \\ E2 & yz = y \\ E3 & (x-2)^2 + y^2 = 1 \end{cases}$$

The easiest equation to start with appears to be $E2$. While it may be tempting to divide both sides of $E2$ by y , we caution against this practice because it presupposes $y \neq 0$. Instead, we take $E2$ and rewrite it as $yz - y = 0$ so $y(z - 1) = 0$. From this, we get two cases: $y = 0$ or $z = 1$. We take each case in turn.

CASE 1: $y = 0$. Substituting $y = 0$ into $E1$ and $E3$, we get

$$\begin{cases} E1 & z(x-2) = x \\ E3 & (x-2)^2 = 1 \end{cases}$$

Solving $E3$ for x gives $x = 1$ or $x = 3$. Substituting these values into $E1$ gives $z = -1$ when $x = 1$ and $z = 3$ when $x = 3$. We obtain two solutions, $(1, 0, -1)$ and $(3, 0, 3)$.

CASE 2: $z = 1$. Substituting $z = 1$ into $E1$ and $E3$ gives us

$$\begin{cases} E1 & (1)(x-2) = x \\ E3 & (1-2)^2 + y^2 = 1 \end{cases}$$

Equation $E1$ gives us $x - 2 = x$ or $-2 = 0$, which is a contradiction. This means we have no solution to the system in this case, even though $E3$ is solvable and gives $y = 0$. Hence, our final answer is $\{(1, 0, -1), (3, 0, 3)\}$. These points are easy enough to check algebraically in our three original equations, so that is left to the reader. As for verifying these solutions graphically, they require plotting surfaces in three dimensions and looking for intersection points. While this is beyond the scope of this book, we provide a snapshot of the graphs of our three equations near one of the solution points, $(1, 0, -1)$.

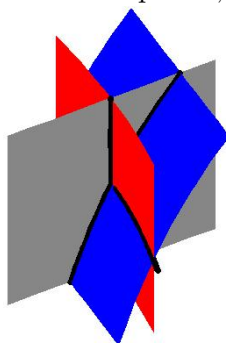

□

Example 7.2.2 showcases some of the ingenuity and tenacity mentioned at the beginning of the section. Sometimes you just have to look at a system the right way to find the most efficient method to solve it. Sometimes you just have to try something.

We close this section discussing how non-linear inequalities can be used to describe regions in the plane which we first introduced in Section 2.4. Before we embark on some examples, a little motivation is in order. Suppose we wish to solve $x^2 < 4 - y^2$. If we mimic the algorithms for solving nonlinear inequalities in one variable, we would gather all of the terms on one side and leave a 0 on the other to obtain $x^2 + y^2 - 4 < 0$. Then we would find the zeros of the left hand side, that is, where is $x^2 + y^2 - 4 = 0$, or $x^2 + y^2 = 4$. Instead of obtaining a few *numbers* which divide the real number *line* into *intervals*, we get an equation of a *curve*, in this case, a circle, which divides the *plane* into two *regions* - the ‘inside’ and ‘outside’ of the circle - with the circle itself as the boundary between the two. Just like we used test *values* to determine whether or not an interval belongs to the solution of the inequality, we use test *points* in the each of the regions to see which of these belong to our solution set.³ We choose $(0, 0)$ to represent the region inside the circle and $(0, 3)$ to represent the points outside of the circle. When we substitute $(0, 0)$ into $x^2 + y^2 - 4 < 0$, we get $-4 < 4$ which is true. This means $(0, 0)$ and all the other points inside the circle are part of the solution. On the other hand, when we substitute $(0, 3)$ into the same inequality, we get $5 < 0$ which is false. This means $(0, 3)$ along with all other points outside the circle are not part of the solution. What about points on the circle itself? Choosing a point on the circle, say $(0, 2)$, we get $0 < 0$, which means the circle itself does not satisfy the inequality.⁴ As a result, we leave the circle dashed in the final diagram.

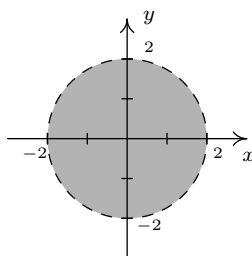

The solution to $x^2 < 4 - y^2$

We put this technique to good use in the following example.

Example 7.2.3. Sketch the solution to the following nonlinear inequalities in the plane.

1. $y^2 - 4 \leq x < y + 2$

2.
$$\begin{cases} x^2 + y^2 \geq 4 \\ x^2 - 2x + y^2 - 2y \leq 0 \end{cases}$$

Solution.

1. The inequality $y^2 - 4 \leq x < y + 2$ is a compound inequality. It translates as $y^2 - 4 \leq x$ and $x < y + 2$. As usual, we solve each inequality and take the set theoretic intersection to determine the region which satisfies both inequalities. To solve $y^2 - 4 \leq x$, we write

³The theory behind why all this works is, surprisingly, the same theory which guarantees that sign diagrams work the way they do - continuity and the Intermediate Value Theorem - but in this case, applied to functions of more than one variable.

⁴Another way to see this is that points on the circle satisfy $x^2 + y^2 - 4 = 0$, so they do not satisfy $x^2 + y^2 - 4 < 0$.

$y^2 - x - 4 \leq 0$. The curve $y^2 - x - 4 = 0$ describes a parabola since exactly one of the variables is squared. Rewriting this in standard form, we get $y^2 = x + 4$ and we see that the vertex is $(-4, 0)$ and the parabola opens to the right. Using the test points $(-5, 0)$ and $(0, 0)$, we find that the solution to the inequality includes the region to the right of, or 'inside', the parabola. The points on the parabola itself are also part of the solution, since the vertex $(-4, 0)$ satisfies the inequality. We now turn our attention to $x < y + 2$. Proceeding as before, we write $x - y - 2 < 0$ and focus our attention on $x - y - 2 = 0$, which is the line $y = x - 2$. Using the test points $(0, 0)$ and $(0, -4)$, we find points in the region above the line $y = x - 2$ satisfy the inequality. The points on the line $y = x - 2$ do not satisfy the inequality, since the y -intercept $(0, -2)$ does not. We see that these two regions do overlap, and to make the graph more precise, we seek the intersection of these two curves. That is, we need to solve the system of nonlinear equations

$$\begin{cases} (E1) & y^2 = x + 4 \\ (E2) & y = x - 2 \end{cases}$$

Solving $E1$ for x , we get $x = y^2 - 4$. Substituting this into $E2$ gives $y = y^2 - 4 - 2$, or $y^2 - y - 6 = 0$. We find $y = -2$ and $y = 3$ and since $x = y^2 - 4$, we get that the graphs intersect at $(0, -2)$ and $(5, 3)$. Putting all of this together, we get our final answer below.

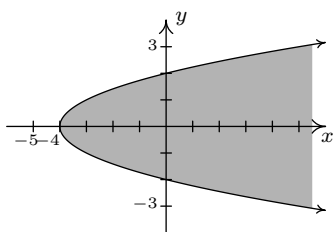

$$y^2 - 4 \leq x$$

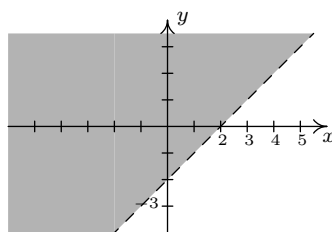

$$x < y + 2$$

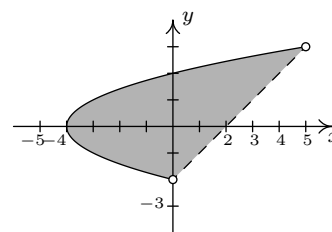

$$y^2 - 4 \leq x < y + 2$$

- To solve this system of inequalities, we need to find all of the points (x, y) which satisfy both inequalities. To do this, we solve each inequality separately and take the set theoretic intersection of the solution sets. We begin with the inequality $x^2 + y^2 \geq 4$ which we rewrite as $x^2 + y^2 - 4 \geq 0$. The points which satisfy $x^2 + y^2 - 4 = 0$ form our friendly circle $x^2 + y^2 = 4$. Using test points $(0, 0)$ and $(0, 3)$ we find that our solution comprises the region outside the circle. As far as the circle itself, the point $(0, 2)$ satisfies the inequality, so the circle itself is part of the solution set. Moving to the inequality $x^2 - 2x + y^2 - 2y \leq 0$, we start with $x^2 - 2x + y^2 - 2y = 0$. Completing the squares, we obtain $(x - 1)^2 + (y - 1)^2 = 2$, which is a circle centered at $(1, 1)$ with a radius of $\sqrt{2}$. Choosing $(1, 1)$ to represent the inside of the circle, $(1, 3)$ as a point outside of the circle and $(0, 0)$ as a point on the circle, we find that the solution to the inequality is the inside of the circle, including the circle itself. Our final answer, then, consists of the points on or outside of the circle $x^2 + y^2 = 4$ which lie on or

inside the circle $(x - 1)^2 + (y - 1)^2 = 2$. To produce the most accurate graph, we need to find where these circles intersect. To that end, we solve the system

$$\begin{cases} (E1) & x^2 + y^2 = 4 \\ (E2) & x^2 - 2x + y^2 - 2y = 0 \end{cases}$$

We can eliminate both the x^2 and y^2 by replacing $E2$ with $-E1 + E2$. Doing so produces $-2x - 2y = -4$. Solving this for y , we get $y = 2 - x$. Substituting this into $E1$ gives $x^2 + (2 - x)^2 = 4$ which simplifies to $x^2 + 4 - 4x + x^2 = 4$ or $2x^2 - 4x = 0$. Factoring yields $2x(x - 2)$ which gives $x = 0$ or $x = 2$. Substituting these values into $y = 2 - x$ gives the points $(0, 2)$ and $(2, 0)$. The intermediate graphs and final solution are below.

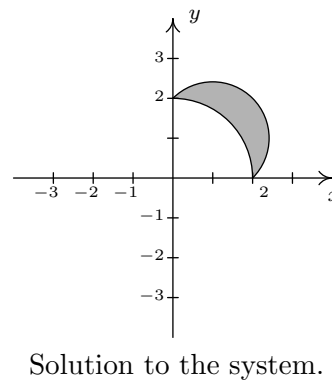
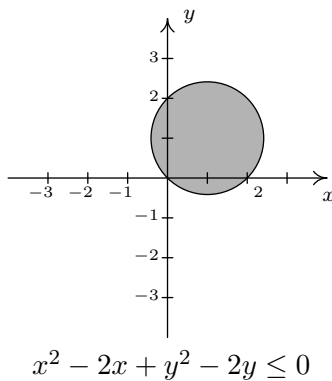
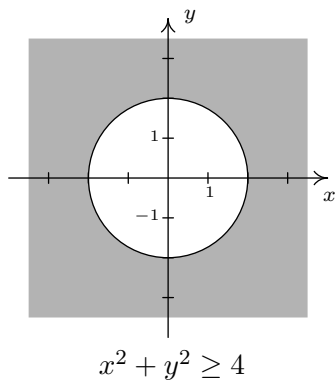

□

7.2.1 EXERCISES

In Exercises 1 - 6, solve the given system of nonlinear equations. Sketch the graph of both equations on the same set of axes to verify the solution set.

$$\begin{array}{lll}
 1. \begin{cases} x^2 - y = 4 \\ x^2 + y^2 = 4 \end{cases} & 2. \begin{cases} x^2 + y^2 = 4 \\ x^2 - y = 5 \end{cases} & 3. \begin{cases} x^2 + y^2 = 16 \\ 16x^2 + 4y^2 = 64 \end{cases} \\
 4. \begin{cases} x^2 + y^2 = 16 \\ 9x^2 - 16y^2 = 144 \end{cases} & 5. \begin{cases} x^2 + y^2 = 16 \\ \frac{1}{9}y^2 - \frac{1}{16}x^2 = 1 \end{cases} & 6. \begin{cases} x^2 + y^2 = 16 \\ x - y = 2 \end{cases}
 \end{array}$$

In Exercises 9 - 15, solve the given system of nonlinear equations. Use a graph to help you avoid any potential extraneous solutions.

$$\begin{array}{lll}
 7. \begin{cases} x^2 - y^2 = 1 \\ x^2 + 4y^2 = 4 \end{cases} & 8. \begin{cases} \sqrt{x+1} - y = 0 \\ x^2 + 4y^2 = 4 \end{cases} & 9. \begin{cases} x + 2y^2 = 2 \\ x^2 + 4y^2 = 4 \end{cases} \\
 10. \begin{cases} (x-2)^2 + y^2 = 1 \\ x^2 + 4y^2 = 4 \end{cases} & 11. \begin{cases} x^2 + y^2 = 25 \\ y - x = 1 \end{cases} & 12. \begin{cases} x^2 + y^2 = 25 \\ x^2 + (y-3)^2 = 10 \end{cases} \\
 13. \begin{cases} y = x^3 + 8 \\ y = 10x - x^2 \end{cases} & 14. \begin{cases} x^2 - xy = 8 \\ y^2 - xy = 8 \end{cases} & 15. \begin{cases} x^2 + y^2 = 25 \\ 4x^2 - 9y = 0 \\ 3y^2 - 16x = 0 \end{cases}
 \end{array}$$

16. A certain bacteria culture follows the Law of Uninbited Growth, Equation 6.4. After 10 minutes, there are 10,000 bacteria. Five minutes later, there are 14,000 bacteria. How many bacteria were present initially? How long before there are 50,000 bacteria?

Consider the system of nonlinear equations below

$$\begin{cases} \frac{4}{x} + \frac{3}{y} = 1 \\ \frac{3}{x} + \frac{2}{y} = -1 \end{cases}$$

If we let $u = \frac{1}{x}$ and $v = \frac{1}{y}$ then the system becomes

$$\begin{cases} 4u + 3v = 1 \\ 3u + 2v = -1 \end{cases}$$

This associated system of linear equations can then be solved using any of the techniques presented earlier in the chapter to find that $u = -5$ and $v = 7$. Thus $x = \frac{1}{u} = -\frac{1}{5}$ and $y = \frac{1}{v} = \frac{1}{7}$.

We say that the original system is **linear in form** because its equations are not linear but a few substitutions reveal a structure that we can treat like a system of linear equations. Each system in Exercises 17 - 19 is linear in form. Make the appropriate substitutions and solve for x and y .

$$17. \begin{cases} 4x^3 + 3\sqrt{y} = 1 \\ 3x^3 + 2\sqrt{y} = -1 \end{cases} \quad 18. \begin{cases} 4e^x + 3e^{-y} = 1 \\ 3e^x + 2e^{-y} = -1 \end{cases} \quad 19. \begin{cases} 4\ln(x) + 3y^2 = 1 \\ 3\ln(x) + 2y^2 = -1 \end{cases}$$

20. Solve the following system

$$\begin{cases} x^2 + \sqrt{y} + \log_2(z) = 6 \\ 3x^2 - 2\sqrt{y} + 2\log_2(z) = 5 \\ -5x^2 + 3\sqrt{y} + 4\log_2(z) = 13 \end{cases}$$

In Exercises 21 - 26, sketch the solution to each system of nonlinear inequalities in the plane.

$$21. \begin{cases} x^2 - y^2 \leq 1 \\ x^2 + 4y^2 \geq 4 \end{cases} \quad 22. \begin{cases} x^2 + y^2 < 25 \\ x^2 + (y-3)^2 \geq 10 \end{cases}$$

$$23. \begin{cases} (x-2)^2 + y^2 < 1 \\ x^2 + 4y^2 < 4 \end{cases} \quad 24. \begin{cases} y > 10x - x^2 \\ y < x^3 + 8 \end{cases}$$

$$25. \begin{cases} x + 2y^2 > 2 \\ x^2 + 4y^2 \leq 4 \end{cases} \quad 26. \begin{cases} x^2 + y^2 \geq 25 \\ y - x \leq 1 \end{cases}$$

27. Systems of nonlinear equations show up in third semester Calculus in the midst of some really cool problems. The system below came from a problem in which we were asked to find the dimensions of a rectangular box with a volume of 1000 cubic inches that has minimal surface area. The variables x , y and z are the dimensions of the box and λ is called a Lagrange multiplier. With the help of your classmates, solve the system.⁵

$$\begin{cases} 2y + 2z = \lambda yz \\ 2x + 2z = \lambda xz \\ 2y + 2x = \lambda xy \\ xyz = 1000 \end{cases}$$

28. According to Theorem 3.16 in Section 3.4, the polynomial $p(x) = x^4 + 4$ can be factored into the product linear and irreducible quadratic factors. In this exercise, we present a method for obtaining that factorization.

- Show that p has no real zeros.
- Because p has no real zeros, its factorization must be of the form $(x^2 + ax + b)(x^2 + cx + d)$ where each factor is an irreducible quadratic. Expand this quantity and gather like terms together.
- Create and solve the system of nonlinear equations which results from equating the coefficients of the expansion found above with those of $x^4 + 4$. You should get four equations in the four unknowns a , b , c and d . Write $p(x)$ in factored form.

29. Factor $q(x) = x^4 + 6x^2 - 5x + 6$.

⁵If using λ bothers you, change it to w when you solve the system.

7.2.2 ANSWERS

1. $(\pm 2, 0), (\pm\sqrt{3}, -1)$

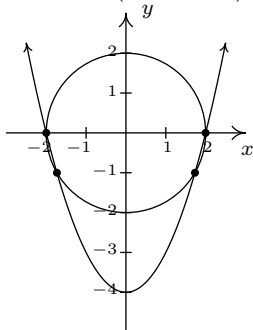

2. No solution

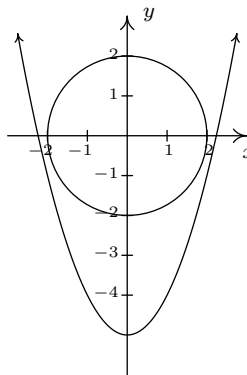

3. $(0, \pm 4)$

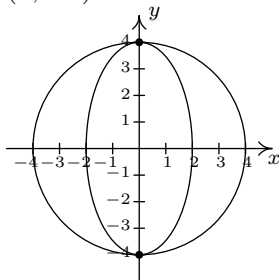

4. $(\pm 4, 0)$

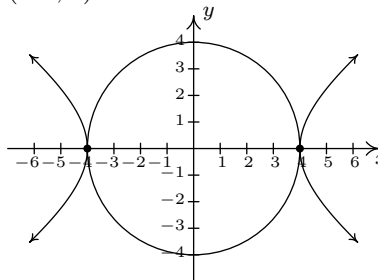

5. $(\pm \frac{4\sqrt{7}}{5}, \pm \frac{12\sqrt{2}}{5})$

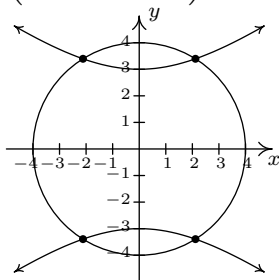

6. $(1 + \sqrt{7}, -1 + \sqrt{7}), (1 - \sqrt{7}, -1 - \sqrt{7})$

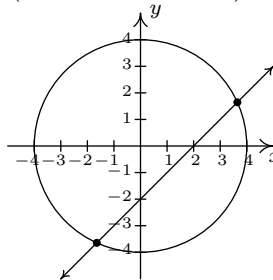

7. $(\pm \frac{2\sqrt{10}}{5}, \pm \frac{\sqrt{15}}{5})$

8. $(0, 1)$

9. $(0, \pm 1), (2, 0)$

10. $(\frac{4}{3}, \pm \frac{\sqrt{5}}{3})$

11. $(3, 4), (-4, -3)$

12. $(\pm 3, 4)$

13. $(-4, -56), (1, 9), (2, 16)$

14. $(-2, 2), (2, -2)$

15. $(3, 4)$

16. Initially, there are $\frac{250000}{49} \approx 5102$ bacteria. It will take $\frac{5 \ln(49/5)}{\ln(7/5)} \approx 33.92$ minutes for the colony to grow to 50,000 bacteria.

17. $(-\sqrt[3]{5}, 49)$

18. No solution

19. $(e^{-5}, \pm\sqrt{7})$

20. $(1, 4, 8), (-1, 4, 8)$

21.
$$\begin{cases} x^2 - y^2 \leq 1 \\ x^2 + 4y^2 \geq 4 \end{cases}$$

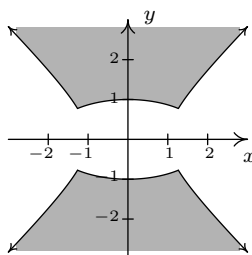

22.
$$\begin{cases} x^2 + y^2 < 25 \\ x^2 + (y - 3)^2 \geq 10 \end{cases}$$

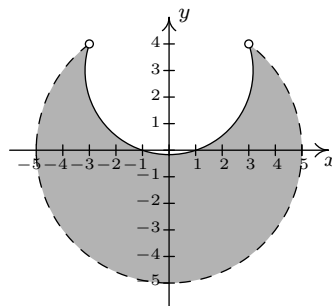

23.
$$\begin{cases} (x - 2)^2 + y^2 < 1 \\ x^2 + 4y^2 < 4 \end{cases}$$

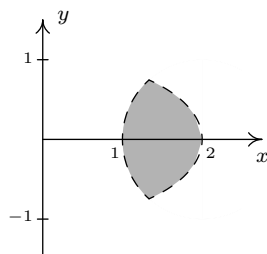

24.
$$\begin{cases} y > 10x - x^2 \\ y < x^3 + 8 \end{cases}$$

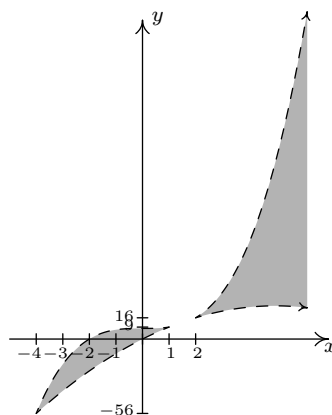

25.
$$\begin{cases} x + 2y^2 > 2 \\ x^2 + 4y^2 \leq 4 \end{cases}$$

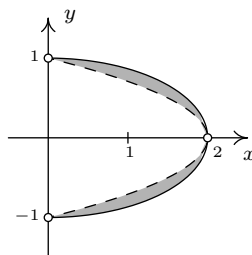

26.
$$\begin{cases} x^2 + y^2 \geq 25 \\ y - x \leq 1 \end{cases}$$

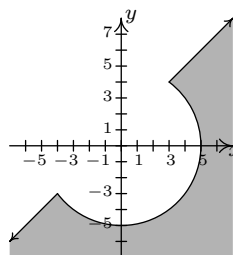

27. $x = 10, y = 10, z = 10, \lambda = \frac{2}{5}$

28. (c) $x^4 + 4 = (x^2 - 2x + 2)(x^2 + 2x + 2)$

29. $x^4 + 6x^2 - 5x + 6 = (x^2 - x + 1)(x^2 + x + 6)$

CHAPTER 8

FOUNDATIONS OF TRIGONOMETRY

8.1 ANGLES AND THEIR MEASURE

This section begins our study of Trigonometry and to get started, we recall some basic definitions from Geometry. A **ray** is usually described as a ‘half-line’ and can be thought of as a line segment in which one of the two endpoints is pushed off infinitely distant from the other, as pictured below. The point from which the ray originates is called the **initial point** of the ray.

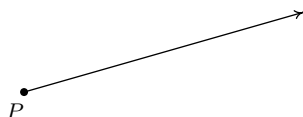

A ray with initial point P .

When two rays share a common initial point they form an **angle** and the common initial point is called the **vertex** of the angle. Two examples of what are commonly thought of as angles are

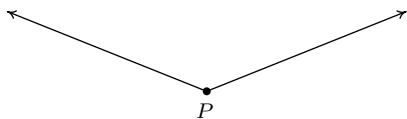

An angle with vertex P .

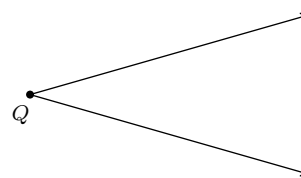

An angle with vertex Q .

However, the two figures below also depict angles - albeit these are, in some sense, extreme cases. In the first case, the two rays are directly opposite each other forming what is known as a **straight angle**; in the second, the rays are identical so the ‘angle’ is indistinguishable from the ray itself.

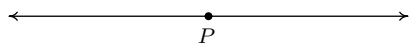

A straight angle.



The **measure of an angle** is a number which indicates the amount of rotation that separates the rays of the angle. There is one immediate problem with this, as pictured below.



Which amount of rotation are we attempting to quantify? What we have just discovered is that we have at least two angles described by this diagram.¹ Clearly these two angles have different measures because one appears to represent a larger rotation than the other, so we must label them differently. In this book, we use lower case Greek letters such as α (alpha), β (beta), γ (gamma) and θ (theta) to label angles. So, for instance, we have

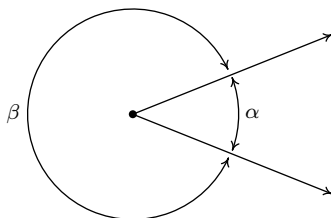

One commonly used system to measure angles is **degree measure**. Quantities measured in degrees are denoted by the familiar ‘°’ symbol. One complete revolution as shown below is 360° , and parts of a revolution are measured proportionately.² Thus half of a revolution (a straight angle) measures $\frac{1}{2}(360^\circ) = 180^\circ$, a quarter of a revolution (a **right angle**) measures $\frac{1}{4}(360^\circ) = 90^\circ$ and so on.

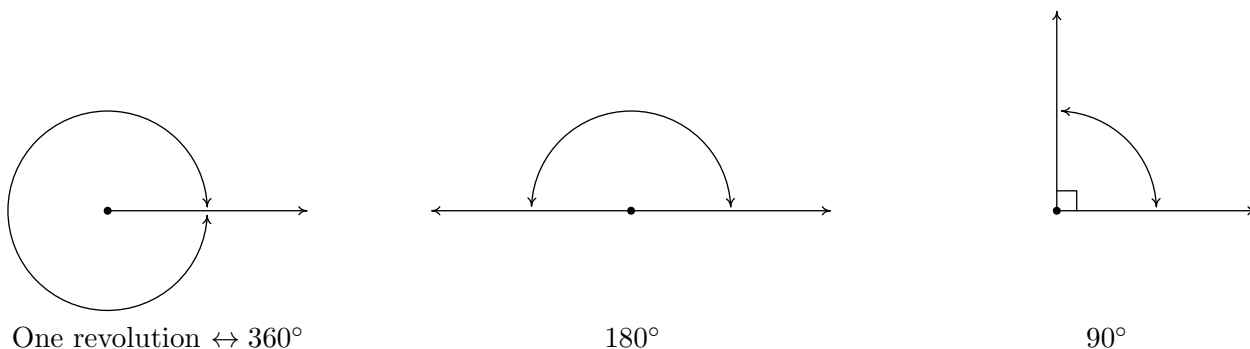

Note that in the above figure, we have used the small square ‘□’ to denote a right angle, as is commonplace in Geometry. Recall that if an angle measures strictly between 0° and 90° it is called an **acute angle** and if it measures strictly between 90° and 180° it is called an **obtuse angle**. It is important to note that, theoretically, we can know the measure of any angle as long as we

¹The phrase ‘at least’ will be justified in short order.

²The choice of ‘360’ is most often attributed to the [Babylonians](#).

know the proportion it represents of entire revolution.³ For instance, the measure of an angle which represents a rotation of $\frac{2}{3}$ of a revolution would measure $\frac{2}{3}(360^\circ) = 240^\circ$, the measure of an angle which constitutes only $\frac{1}{12}$ of a revolution measures $\frac{1}{12}(360^\circ) = 30^\circ$ and an angle which indicates no rotation at all is measured as 0° .

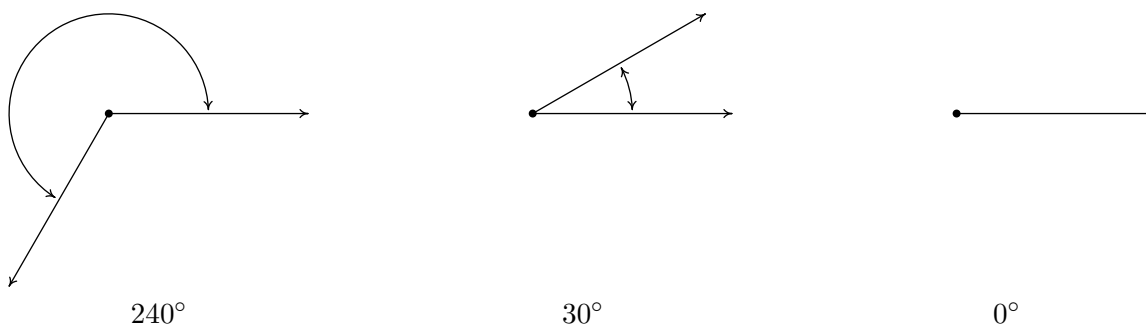

Using our definition of degree measure, we have that 1° represents the measure of an angle which constitutes $\frac{1}{360}$ of a revolution. Even though it may be hard to draw, it is nonetheless not difficult to imagine an angle with measure smaller than 1° . There are two ways to subdivide degrees. The first, and most familiar, is **decimal degrees**. For example, an angle with a measure of 30.5° would represent a rotation halfway between 30° and 31° , or equivalently, $\frac{30.5}{360} = \frac{61}{720}$ of a full rotation. This can be taken to the limit using Calculus so that measures like $\sqrt{2}^\circ$ make sense.⁴ The second way to divide degrees is the **Degree - Minute - Second (DMS)** system. In this system, one degree is divided equally into sixty minutes, and in turn, each minute is divided equally into sixty seconds.⁵ In symbols, we write $1^\circ = 60'$ and $1' = 60''$, from which it follows that $1^\circ = 3600''$. To convert a measure of 42.125° to the DMS system, we start by noting that $42.125^\circ = 42^\circ + 0.125^\circ$. Converting the partial amount of degrees to minutes, we find $0.125^\circ \left(\frac{60'}{1^\circ}\right) = 7.5' = 7' + 0.5'$. Converting the partial amount of minutes to seconds gives $0.5' \left(\frac{60''}{1'}\right) = 30''$. Putting it all together yields

$$\begin{aligned}
 42.125^\circ &= 42^\circ + 0.125^\circ \\
 &= 42^\circ + 7.5' \\
 &= 42^\circ + 7' + 0.5' \\
 &= 42^\circ + 7' + 30'' \\
 &= 42^\circ 7' 30''
 \end{aligned}$$

On the other hand, to convert $117^\circ 15' 45''$ to decimal degrees, we first compute $15' \left(\frac{1^\circ}{60'}\right) = \frac{1}{4}^\circ$ and $45'' \left(\frac{1^\circ}{3600''}\right) = \frac{1}{80}^\circ$. Then we find

³This is how a protractor is graded.

⁴Awesome math pun aside, this is the same idea behind defining irrational exponents in Section 6.1.

⁵Does this kind of system seem familiar?

$$\begin{aligned}
 117^\circ 15' 45'' &= 117^\circ + 15' + 45'' \\
 &= 117^\circ + \frac{1}{4}^\circ + \frac{1}{80}^\circ \\
 &= \frac{9381}{80}^\circ \\
 &= 117.2625^\circ
 \end{aligned}$$

Recall that two acute angles are called **complementary angles** if their measures add to 90° . Two angles, either a pair of right angles or one acute angle and one obtuse angle, are called **supplementary angles** if their measures add to 180° . In the diagram below, the angles α and β are supplementary angles while the pair γ and θ are complementary angles.

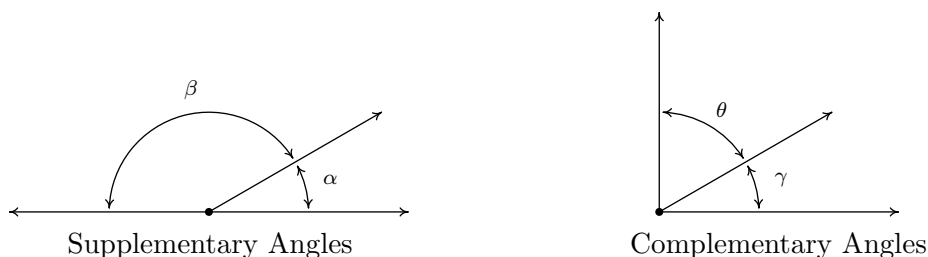

In practice, the distinction between the angle itself and its measure is blurred so that the sentence ‘ α is an angle measuring 42° ’ is often abbreviated as ‘ $\alpha = 42^\circ$.’ It is now time for an example.

Example 8.1.1. Let $\alpha = 111.371^\circ$ and $\beta = 37^\circ 28' 17''$.

1. Convert α to the DMS system. Round your answer to the nearest second.
2. Convert β to decimal degrees. Round your answer to the nearest thousandth of a degree.
3. Sketch α and β .
4. Find a supplementary angle for α .
5. Find a complementary angle for β .

Solution.

1. To convert α to the DMS system, we start with $111.371^\circ = 111^\circ + 0.371^\circ$. Next we convert $0.371^\circ \left(\frac{60'}{1^\circ} \right) = 22.26'$. Writing $22.26' = 22' + 0.26'$, we convert $0.26' \left(\frac{60''}{1'} \right) = 15.6''$. Hence,

$$\begin{aligned}
 111.371^\circ &= 111^\circ + 0.371^\circ \\
 &= 111^\circ + 22.26' \\
 &= 111^\circ + 22' + 0.26' \\
 &= 111^\circ + 22' + 15.6'' \\
 &= 111^\circ 22' 15.6''
 \end{aligned}$$

Rounding to seconds, we obtain $\alpha \approx 111^\circ 22' 16''$.

2. To convert β to decimal degrees, we convert $28' \left(\frac{1^\circ}{60'}\right) = \frac{7}{15}^\circ$ and $17'' \left(\frac{1^\circ}{3600''}\right) = \frac{17}{3600}^\circ$. Putting it all together, we have

$$\begin{aligned} 37^\circ 28' 17'' &= 37^\circ + 28' + 17'' \\ &= 37^\circ + \frac{7}{15}^\circ + \frac{17}{3600}^\circ \\ &= \frac{134897}{3600}^\circ \\ &\approx 37.471^\circ \end{aligned}$$

3. To sketch α , we first note that $90^\circ < \alpha < 180^\circ$. If we divide this range in half, we get $90^\circ < \alpha < 135^\circ$, and once more, we have $90^\circ < \alpha < 112.5^\circ$. This gives us a pretty good estimate for α , as shown below.⁶ Proceeding similarly for β , we find $0^\circ < \beta < 90^\circ$, then $0^\circ < \beta < 45^\circ$, $22.5^\circ < \beta < 45^\circ$, and lastly, $33.75^\circ < \beta < 45^\circ$.

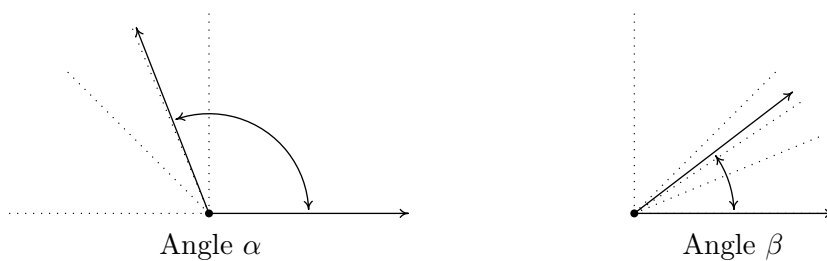

4. To find a supplementary angle for α , we seek an angle θ so that $\alpha + \theta = 180^\circ$. We get $\theta = 180^\circ - \alpha = 180^\circ - 111.371^\circ = 68.629^\circ$.
5. To find a complementary angle for β , we seek an angle γ so that $\beta + \gamma = 90^\circ$. We get $\gamma = 90^\circ - \beta = 90^\circ - 37^\circ 28' 17''$. While we could reach for the calculator to obtain an approximate answer, we choose instead to do a bit of sexagesimal⁷ arithmetic. We first rewrite $90^\circ = 90^\circ 0' 0'' = 89^\circ 60' 0'' = 89^\circ 59' 60''$. In essence, we are ‘borrowing’ $1^\circ = 60'$ from the degree place, and then borrowing $1' = 60''$ from the minutes place.⁸ This yields, $\gamma = 90^\circ - 37^\circ 28' 17'' = 89^\circ 59' 60'' - 37^\circ 28' 17'' = 52^\circ 31' 43''$. \square

Up to this point, we have discussed only angles which measure between 0° and 360° , inclusive. Ultimately, we want to use the arsenal of Algebra which we have stockpiled in this course to not only solve geometric problems involving angles, but also to extend their applicability to other real-world phenomena. A first step in this direction is to extend our notion of ‘angle’ from merely measuring an extent of rotation to quantities which can be associated with real numbers. To that end, we introduce the concept of an **oriented angle**. As its name suggests, in an oriented angle,

⁶If this process seems hauntingly familiar, it should. Compare this method to the Bisection Method introduced in Section 3.3.

⁷Like ‘latus rectum,’ this is also a real math term.

⁸This is the exact same kind of ‘borrowing’ you used to do in Elementary School when trying to find $300 - 125$. Back then, you were working in a base ten system; here, it is base sixty.

the direction of the rotation is important. We imagine the angle being swept out starting from an **initial side** and ending at a **terminal side**, as shown below. When the rotation is counter-clockwise⁹ from initial side to terminal side, we say that the angle is **positive**; when the rotation is clockwise, we say that the angle is **negative**.

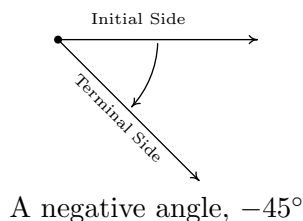
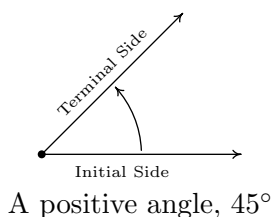

At this point, we also extend our allowable rotations to include angles which encompass more than one revolution. For example, to sketch an angle with measure 450° we start with an initial side, rotate counter-clockwise one complete revolution (to take care of the ‘first’ 360°) then continue with an additional 90° counter-clockwise rotation, as seen below.

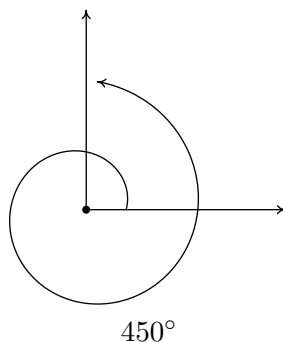

To further connect angles with the Algebra which has come before, we shall often overlay an angle diagram on the coordinate plane. An angle is said to be in **standard position** if its vertex is the origin and its initial side coincides with the positive x -axis. Angles in standard position are classified according to where their terminal side lies. For instance, an angle in standard position whose terminal side lies in Quadrant I is called a ‘Quadrant I angle’. If the terminal side of an angle lies on one of the coordinate axes, it is called a **quadrantal angle**. Two angles in standard position are called **coterminal** if they share the same terminal side.¹⁰ In the figure below, $\alpha = 120^\circ$ and $\beta = -240^\circ$ are two coterminal Quadrant II angles drawn in standard position. Note that $\alpha = \beta + 360^\circ$, or equivalently, $\beta = \alpha - 360^\circ$. We leave it as an exercise to the reader to verify that coterminal angles always differ by a multiple of 360° .¹¹ More precisely, if α and β are coterminal angles, then $\beta = \alpha + 360^\circ \cdot k$ where k is an integer.¹²

⁹‘widdershins’

¹⁰Note that by being in standard position they automatically share the same initial side which is the positive x -axis.

¹¹It is worth noting that all of the pathologies of Analytic Trigonometry result from this innocuous fact.

¹²Recall that this means $k = 0, \pm 1, \pm 2, \dots$

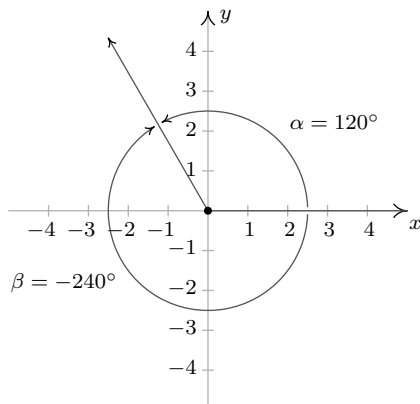

Two coterminal angles, $\alpha = 120^\circ$ and $\beta = -240^\circ$, in standard position.

Example 8.1.2. Graph each of the (oriented) angles below in standard position and classify them according to where their terminal side lies. Find three coterminal angles, at least one of which is positive and one of which is negative.

1. $\alpha = 60^\circ$
2. $\beta = -225^\circ$
3. $\gamma = 540^\circ$
4. $\phi = -750^\circ$

Solution.

1. To graph $\alpha = 60^\circ$, we draw an angle with its initial side on the positive x -axis and rotate counter-clockwise $\frac{60^\circ}{360^\circ} = \frac{1}{6}$ of a revolution. We see that α is a Quadrant I angle. To find angles which are coterminal, we look for angles θ of the form $\theta = \alpha + 360^\circ \cdot k$, for some integer k . When $k = 1$, we get $\theta = 60^\circ + 360^\circ = 420^\circ$. Substituting $k = -1$ gives $\theta = 60^\circ - 360^\circ = -300^\circ$. Finally, if we let $k = 2$, we get $\theta = 60^\circ + 720^\circ = 780^\circ$.
2. Since $\beta = -225^\circ$ is negative, we start at the positive x -axis and rotate *clockwise* $\frac{225^\circ}{360^\circ} = \frac{5}{8}$ of a revolution. We see that β is a Quadrant II angle. To find coterminal angles, we proceed as before and compute $\theta = -225^\circ + 360^\circ \cdot k$ for integer values of k . We find 135° , -585° and 495° are all coterminal with -225° .

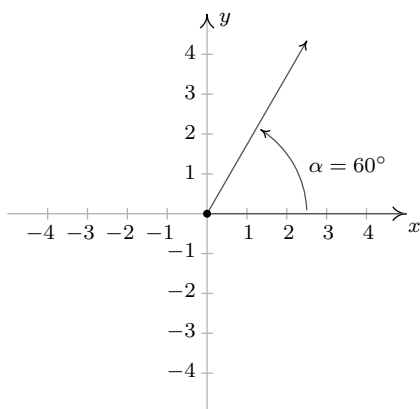

$\alpha = 60^\circ$ in standard position.

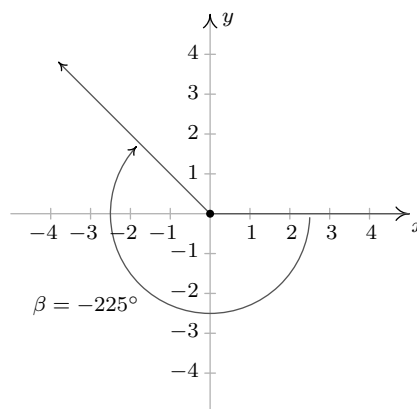

$\beta = -225^\circ$ in standard position.

3. Since $\gamma = 540^\circ$ is positive, we rotate counter-clockwise from the positive x -axis. One full revolution accounts for 360° , with 180° , or $\frac{1}{2}$ of a revolution remaining. Since the terminal side of γ lies on the negative x -axis, γ is a quadrantal angle. All angles coterminal with γ are of the form $\theta = 540^\circ + 360^\circ \cdot k$, where k is an integer. Working through the arithmetic, we find three such angles: 180° , -180° and 900° .
4. The Greek letter ϕ is pronounced 'fee' or 'fie' and since ϕ is negative, we begin our rotation clockwise from the positive x -axis. Two full revolutions account for 720° , with just 30° or $\frac{1}{12}$ of a revolution to go. We find that ϕ is a Quadrant IV angle. To find coterminal angles, we compute $\theta = -750^\circ + 360^\circ \cdot k$ for a few integers k and obtain -390° , -30° and 330° .

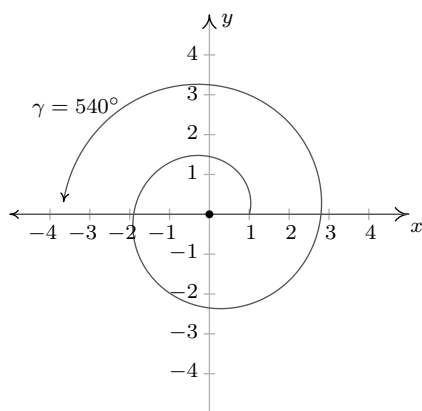

$\gamma = 540^\circ$ in standard position.

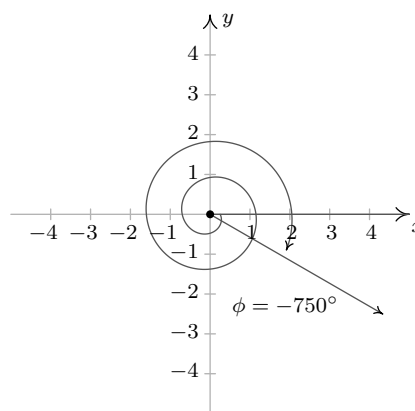

$\phi = -750^\circ$ in standard position.

□

Note that since there are infinitely many integers, any given angle has infinitely many coterminal angles, and the reader is encouraged to plot the few sets of coterminal angles found in Example 8.1.2 to see this. We are now just one step away from completely marrying angles with the real numbers and the rest of Algebra. To that end, we recall this definition from Geometry.

Definition 8.1. The real number π is defined to be the ratio of a circle's circumference to its diameter. In symbols, given a circle of circumference C and diameter d ,

$$\pi = \frac{C}{d}$$

While Definition 8.1 is quite possibly the 'standard' definition of π , the authors would be remiss if we didn't mention that buried in this definition is actually a theorem. As the reader is probably aware, the number π is a mathematical constant - that is, it doesn't matter *which* circle is selected, the ratio of its circumference to its diameter will have the same value as any other circle. While this is indeed true, it is far from obvious and leads to a counterintuitive scenario which is explored in the Exercises. Since the diameter of a circle is twice its radius, we can quickly rearrange the equation in Definition 8.1 to get a formula more useful for our purposes, namely: $2\pi = \frac{C}{r}$

This tells us that for any circle, the ratio of its circumference to its radius is also always constant; in this case the constant is 2π . Suppose now we take a *portion* of the circle, so instead of comparing the entire circumference C to the radius, we compare some arc measuring s units in length to the radius, as depicted below. Let θ be the **central angle** subtended by this arc, that is, an angle whose vertex is the center of the circle and whose determining rays pass through the endpoints of the arc. Using proportionality arguments, it stands to reason that the ratio $\frac{s}{r}$ should also be a constant among all circles, and it is this ratio which defines the **radian measure** of an angle.

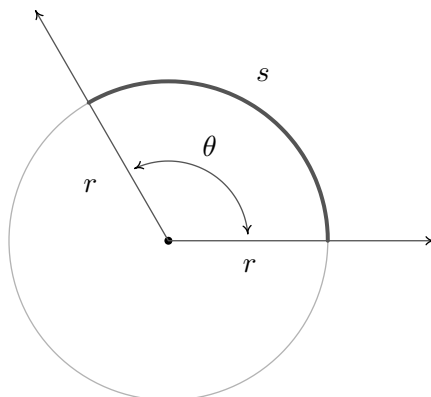

The radian measure of θ is $\frac{s}{r}$.

To get a better feel for radian measure, we note that an angle with radian measure 1 means the corresponding arc length s equals the radius of the circle r , hence $s = r$. When the radian measure is 2, we have $s = 2r$; when the radian measure is 3, $s = 3r$, and so forth. Thus the radian measure of an angle θ tells us how many 'radius lengths' we need to sweep out along the circle to subtend the angle θ .

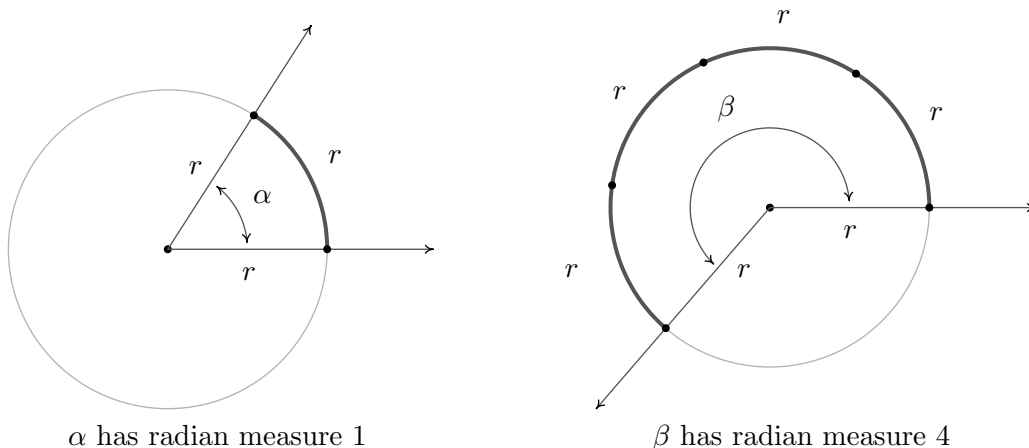

α has radian measure 1

β has radian measure 4

Since one revolution sweeps out the entire circumference $2\pi r$, one revolution has radian measure $\frac{2\pi r}{r} = 2\pi$. From this we can find the radian measure of other central angles using proportions,

just like we did with degrees. For instance, half of a revolution has radian measure $\frac{1}{2}(2\pi) = \pi$, a quarter revolution has radian measure $\frac{1}{4}(2\pi) = \frac{\pi}{2}$, and so forth. Note that, by definition, the radian measure of an angle is a length divided by another length so that these measurements are actually dimensionless and are considered ‘pure’ numbers. For this reason, we do not use any symbols to denote radian measure, but we use the word ‘radians’ to denote these dimensionless units as needed. For instance, we say one revolution measures ‘ 2π radians,’ half of a revolution measures ‘ π radians,’ and so forth.

As with degree measure, the distinction between the angle itself and its measure is often blurred in practice, so when we write ‘ $\theta = \frac{\pi}{2}$ ’, we mean θ is an angle which measures $\frac{\pi}{2}$ radians.¹³ We extend radian measure to oriented angles, just as we did with degrees beforehand, so that a positive measure indicates counter-clockwise rotation and a negative measure indicates clockwise rotation.¹⁴ Much like before, two positive angles α and β are supplementary if $\alpha + \beta = \pi$ and complementary if $\alpha + \beta = \frac{\pi}{2}$. Finally, we leave it to the reader to show that when using radian measure, two angles α and β are coterminal if and only if $\beta = \alpha + 2\pi k$ for some integer k .

Example 8.1.3. Graph each of the (oriented) angles below in standard position and classify them according to where their terminal side lies. Find three coterminal angles, at least one of which is positive and one of which is negative.

1. $\alpha = \frac{\pi}{6}$

2. $\beta = -\frac{4\pi}{3}$

3. $\gamma = \frac{9\pi}{4}$

4. $\phi = -\frac{5\pi}{2}$

Solution.

- The angle $\alpha = \frac{\pi}{6}$ is positive, so we draw an angle with its initial side on the positive x -axis and rotate counter-clockwise $\frac{(\pi/6)}{2\pi} = \frac{1}{12}$ of a revolution. Thus α is a Quadrant I angle. Coterminal angles θ are of the form $\theta = \alpha + 2\pi \cdot k$, for some integer k . To make the arithmetic a bit easier, we note that $2\pi = \frac{12\pi}{6}$, thus when $k = 1$, we get $\theta = \frac{\pi}{6} + \frac{12\pi}{6} = \frac{13\pi}{6}$. Substituting $k = -1$ gives $\theta = \frac{\pi}{6} - \frac{12\pi}{6} = -\frac{11\pi}{6}$ and when we let $k = 2$, we get $\theta = \frac{\pi}{6} + \frac{24\pi}{6} = \frac{25\pi}{6}$.
- Since $\beta = -\frac{4\pi}{3}$ is negative, we start at the positive x -axis and rotate clockwise $\frac{(4\pi/3)}{2\pi} = \frac{2}{3}$ of a revolution. We find β to be a Quadrant II angle. To find coterminal angles, we proceed as before using $2\pi = \frac{6\pi}{3}$, and compute $\theta = -\frac{4\pi}{3} + \frac{6\pi}{3} \cdot k$ for integer values of k . We obtain $\frac{2\pi}{3}$, $-\frac{10\pi}{3}$ and $\frac{8\pi}{3}$ as coterminal angles.

¹³The authors are well aware that we are now identifying radians with real numbers. We will justify this shortly.

¹⁴This, in turn, endows the subtended arcs with an orientation as well. We address this in short order.

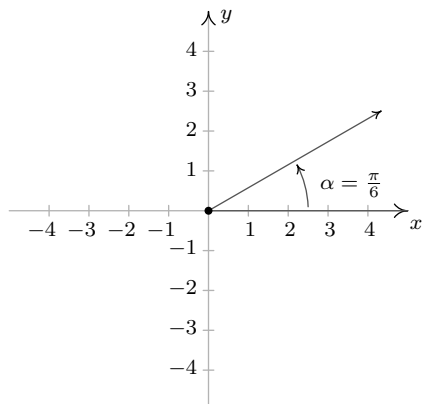

$\alpha = \frac{\pi}{6}$ in standard position.

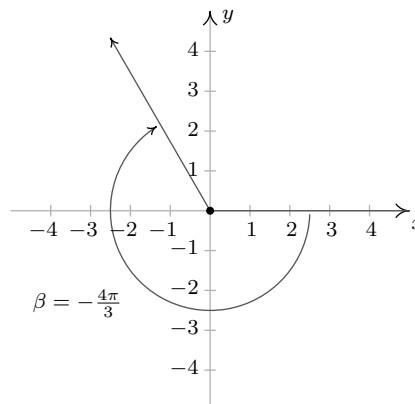

$\beta = -\frac{4\pi}{3}$ in standard position.

- Since $\gamma = \frac{9\pi}{4}$ is positive, we rotate counter-clockwise from the positive x -axis. One full revolution accounts for $2\pi = \frac{8\pi}{4}$ of the radian measure with $\frac{\pi}{4}$ or $\frac{1}{8}$ of a revolution remaining. We have γ as a Quadrant I angle. All angles coterminal with γ are of the form $\theta = \frac{9\pi}{4} + \frac{8\pi}{4} \cdot k$, where k is an integer. Working through the arithmetic, we find: $\frac{\pi}{4}$, $-\frac{7\pi}{4}$ and $\frac{17\pi}{4}$.
- To graph $\phi = -\frac{5\pi}{2}$, we begin our rotation clockwise from the positive x -axis. As $2\pi = \frac{4\pi}{2}$, after one full revolution clockwise, we have $\frac{\pi}{2}$ or $\frac{1}{4}$ of a revolution remaining. Since the terminal side of ϕ lies on the negative y -axis, ϕ is a quadrantal angle. To find coterminal angles, we compute $\theta = -\frac{5\pi}{2} + \frac{4\pi}{2} \cdot k$ for a few integers k and obtain $-\frac{\pi}{2}$, $\frac{3\pi}{2}$ and $\frac{7\pi}{2}$.

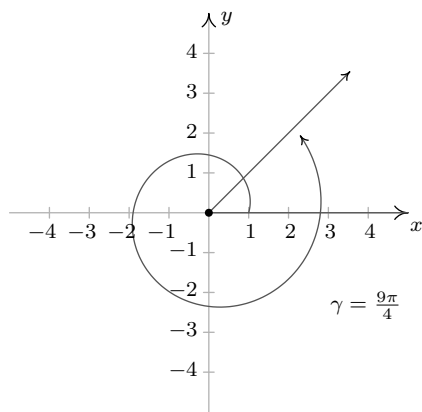

$\gamma = \frac{9\pi}{4}$ in standard position.

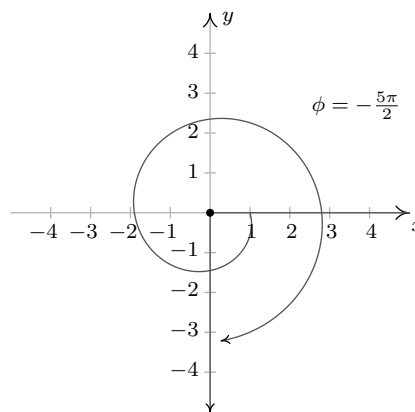

$\phi = -\frac{5\pi}{2}$ in standard position.

□

It is worth mentioning that we could have plotted the angles in Example 8.1.3 by first converting them to degree measure and following the procedure set forth in Example 8.1.2. While converting back and forth from degrees and radians is certainly a good skill to have, it is best that you learn to ‘think in radians’ as well as you can ‘think in degrees’. The authors would, however, be

derelict in our duties if we ignored the basic conversion between these systems altogether. Since one revolution counter-clockwise measures 360° and the same angle measures 2π radians, we can use the proportion $\frac{2\pi \text{ radians}}{360^\circ}$, or its reduced equivalent, $\frac{\pi \text{ radians}}{180^\circ}$, as the conversion factor between the two systems. For example, to convert 60° to radians we find $60^\circ \left(\frac{\pi \text{ radians}}{180^\circ}\right) = \frac{\pi}{3}$ radians, or simply $\frac{\pi}{3}$. To convert from radian measure back to degrees, we multiply by the ratio $\frac{180^\circ}{\pi \text{ radian}}$. For example, $-\frac{5\pi}{6}$ radians is equal to $\left(-\frac{5\pi}{6} \text{ radians}\right) \left(\frac{180^\circ}{\pi \text{ radians}}\right) = -150^\circ$.¹⁵ Of particular interest is the fact that an angle which measures 1 in radian measure is equal to $\frac{180^\circ}{\pi} \approx 57.2958^\circ$.

We summarize these conversions below.

Equation 8.1. Degree - Radian Conversion:

- To convert degree measure to radian measure, multiply by $\frac{\pi \text{ radians}}{180^\circ}$
- To convert radian measure to degree measure, multiply by $\frac{180^\circ}{\pi \text{ radians}}$

In light of Example 8.1.3 and Equation 8.1, the reader may well wonder what the allure of radian measure is. The numbers involved are, admittedly, much more complicated than degree measure. The answer lies in how easily angles in radian measure can be identified with real numbers. Consider the Unit Circle, $x^2 + y^2 = 1$, as drawn below, the angle θ in standard position and the corresponding arc measuring s units in length. By definition, and the fact that the Unit Circle has radius 1, the radian measure of θ is $\frac{s}{r} = \frac{s}{1} = s$ so that, once again blurring the distinction between an angle and its measure, we have $\theta = s$. In order to identify real numbers with oriented angles, we make good use of this fact by essentially ‘wrapping’ the real number line around the Unit Circle and associating to each real number t an *oriented* arc on the Unit Circle with initial point $(1, 0)$.

Viewing the vertical line $x = 1$ as another real number line demarcated like the y -axis, given a real number $t > 0$, we ‘wrap’ the (vertical) interval $[0, t]$ around the Unit Circle in a counter-clockwise fashion. The resulting arc has a length of t units and therefore the corresponding angle has radian measure equal to t . If $t < 0$, we wrap the interval $[t, 0]$ *clockwise* around the Unit Circle. Since we have defined clockwise rotation as having negative radian measure, the angle determined by this arc has radian measure equal to t . If $t = 0$, we are at the point $(1, 0)$ on the x -axis which corresponds to an angle with radian measure 0. In this way, we identify each real number t with the corresponding angle with radian measure t .

¹⁵Note that the negative sign indicates clockwise rotation in both systems, and so it is carried along accordingly.

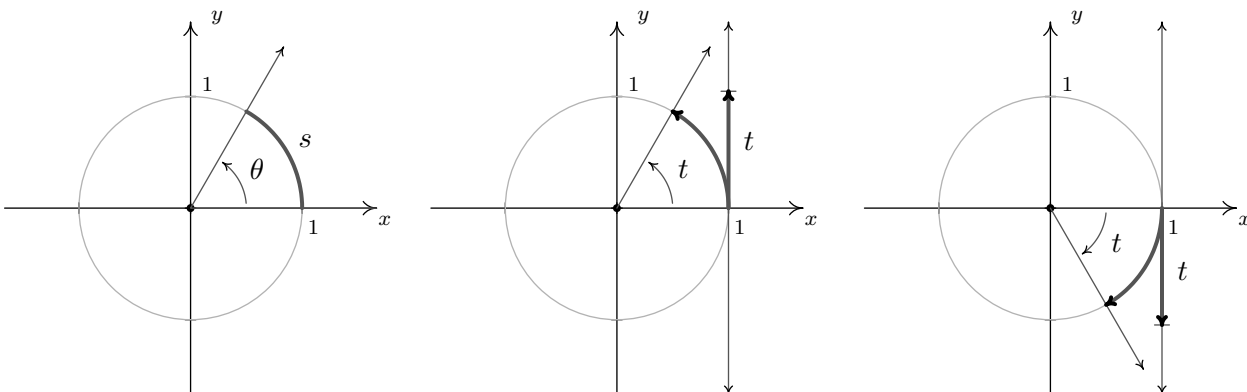

On the Unit Circle, $\theta = s$. Identifying $t > 0$ with an angle. Identifying $t < 0$ with an angle.

Example 8.1.4. Sketch the oriented arc on the Unit Circle corresponding to each of the following real numbers.

1. $t = \frac{3\pi}{4}$

2. $t = -2\pi$

3. $t = -2$

4. $t = 117$

Solution.

- The arc associated with $t = \frac{3\pi}{4}$ is the arc on the Unit Circle which subtends the angle $\frac{3\pi}{4}$ in radian measure. Since $\frac{3\pi}{4}$ is $\frac{3}{8}$ of a revolution, we have an arc which begins at the point $(1, 0)$ proceeds counter-clockwise up to midway through Quadrant II.
- Since one revolution is 2π radians, and $t = -2\pi$ is negative, we graph the arc which begins at $(1, 0)$ and proceeds *clockwise* for one full revolution.

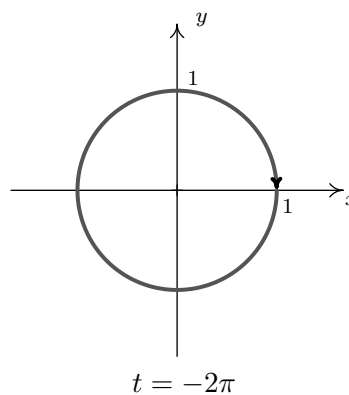
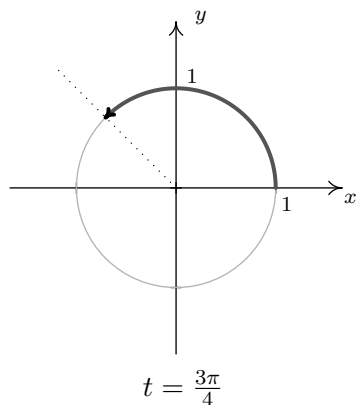

- Like $t = -2\pi$, $t = -2$ is negative, so we begin our arc at $(1, 0)$ and proceed clockwise around the unit circle. Since $\pi \approx 3.14$ and $\frac{\pi}{2} \approx 1.57$, we find that rotating 2 radians clockwise from the point $(1, 0)$ lands us in Quadrant III. To more accurately place the endpoint, we proceed as we did in Example 8.1.1, successively halving the angle measure until we find $\frac{5\pi}{8} \approx 1.96$ which tells us our arc extends just a bit beyond the quarter mark into Quadrant III.

4. Since 117 is positive, the arc corresponding to $t = 117$ begins at $(1, 0)$ and proceeds counter-clockwise. As 117 is much greater than 2π , we wrap around the Unit Circle several times before finally reaching our endpoint. We approximate $\frac{117}{2\pi}$ as 18.62 which tells us we complete 18 revolutions counter-clockwise with 0.62, or just shy of $\frac{5}{8}$ of a revolution to spare. In other words, the terminal side of the angle which measures 117 radians in standard position is just short of being midway through Quadrant III.

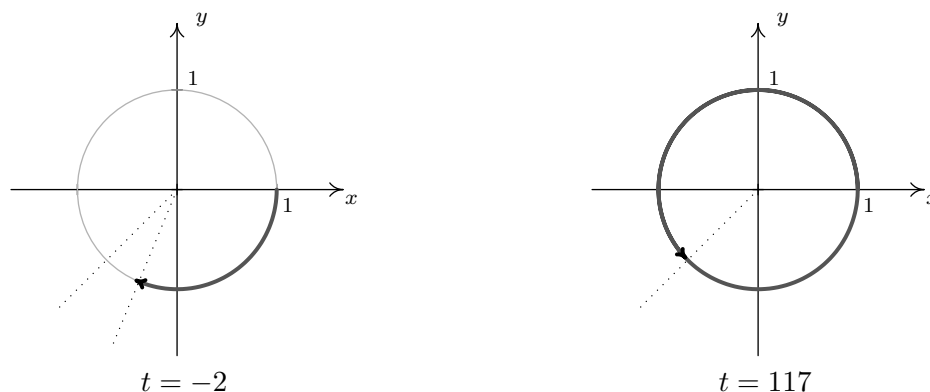

□

8.1.1 APPLICATIONS OF RADIAN MEASURE: CIRCULAR MOTION

Now that we have paired angles with real numbers via radian measure, a whole world of applications awaits us. Our first excursion into this realm comes by way of circular motion. Suppose an object is moving as pictured below along a circular path of radius r from the point P to the point Q in an amount of time t .

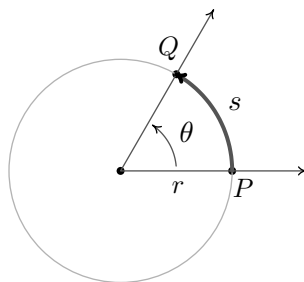

Here s represents a *displacement* so that $s > 0$ means the object is traveling in a counter-clockwise direction and $s < 0$ indicates movement in a clockwise direction. Note that with this convention the formula we used to define radian measure, namely $\theta = \frac{s}{r}$, still holds since a negative value of s incurred from a clockwise displacement matches the negative we assign to θ for a clockwise rotation. In Physics, the **average velocity** of the object, denoted \bar{v} and read as ‘ v -bar’, is defined as the average rate of change of the position of the object with respect to time.¹⁶ As a result, we

¹⁶See Definition 2.3 in Section 2.1 for a review of this concept.

have $\bar{v} = \frac{\text{displacement}}{\text{time}} = \frac{s}{t}$. The quantity \bar{v} has units of $\frac{\text{length}}{\text{time}}$ and conveys two ideas: the direction in which the object is moving and how fast the position of the object is changing. The contribution of direction in the quantity \bar{v} is either to make it positive (in the case of counter-clockwise motion) or negative (in the case of clockwise motion), so that the quantity $|\bar{v}|$ quantifies how fast the object is moving - it is the **speed** of the object. Measuring θ in radians we have $\theta = \frac{s}{r}$ thus $s = r\theta$ and

$$\bar{v} = \frac{s}{t} = \frac{r\theta}{t} = r \cdot \frac{\theta}{t}$$

The quantity $\frac{\theta}{t}$ is called the **average angular velocity** of the object. It is denoted by $\bar{\omega}$ and is read ‘omega-bar’. The quantity $\bar{\omega}$ is the average rate of change of the angle θ with respect to time and thus has units $\frac{\text{radians}}{\text{time}}$. If $\bar{\omega}$ is constant throughout the duration of the motion, then it can be shown¹⁷ that the average velocities involved, namely \bar{v} and $\bar{\omega}$, are the same as their instantaneous counterparts, v and ω , respectively. In this case, v is simply called the ‘velocity’ of the object and is the instantaneous rate of change of the position of the object with respect to time.¹⁸ Similarly, ω is called the ‘angular velocity’ and is the instantaneous rate of change of the angle with respect to time.

If the path of the object were ‘uncurled’ from a circle to form a line segment, then the velocity of the object on that line segment would be the same as the velocity on the circle. For this reason, the quantity v is often called the *linear* velocity of the object in order to distinguish it from the *angular* velocity, ω . Putting together the ideas of the previous paragraph, we get the following.

Equation 8.2. Velocity for Circular Motion: For an object moving on a circular path of radius r with constant angular velocity ω , the (linear) velocity of the object is given by $v = r\omega$.

We need to talk about units here. The units of v are $\frac{\text{length}}{\text{time}}$, the units of r are length only, and the units of ω are $\frac{\text{radians}}{\text{time}}$. Thus the left hand side of the equation $v = r\omega$ has units $\frac{\text{length}}{\text{time}}$, whereas the right hand side has units $\text{length} \cdot \frac{\text{radians}}{\text{time}} = \frac{\text{length} \cdot \text{radians}}{\text{time}}$. The supposed contradiction in units is resolved by remembering that radians are a dimensionless quantity and angles in radian measure are identified with real numbers so that the units $\frac{\text{length} \cdot \text{radians}}{\text{time}}$ reduce to the units $\frac{\text{length}}{\text{time}}$. We are long overdue for an example.

Example 8.1.5. Assuming that the surface of the Earth is a sphere, any point on the Earth can be thought of as an object traveling on a circle which completes one revolution in (approximately) 24 hours. The path traced out by the point during this 24 hour period is the Latitude of that point. Lakeland Community College is at 41.628° north latitude, and it can be shown¹⁹ that the radius of the earth at this Latitude is approximately 2960 miles. Find the linear velocity, in miles per hour, of Lakeland Community College as the world turns.

Solution. To use the formula $v = r\omega$, we first need to compute the angular velocity ω . The earth makes one revolution in 24 hours, and one revolution is 2π radians, so $\omega = \frac{2\pi \text{ radians}}{24 \text{ hours}} = \frac{\pi}{12 \text{ hours}}$,

¹⁷You guessed it, using Calculus . . .

¹⁸See the discussion on Page 295 for more details on the idea of an ‘instantaneous’ rate of change.

¹⁹We will discuss how we arrived at this approximation in Example 8.2.6.

where, once again, we are using the fact that radians are real numbers and are dimensionless. (For simplicity's sake, we are also assuming that we are viewing the rotation of the earth as counter-clockwise so $\omega > 0$.) Hence, the linear velocity is

$$v = 2960 \text{ miles} \cdot \frac{\pi}{12 \text{ hours}} \approx 775 \frac{\text{miles}}{\text{hour}}$$

□

It is worth noting that the quantity $\frac{1 \text{ revolution}}{24 \text{ hours}}$ in Example 8.1.5 is called the **ordinary frequency** of the motion and is usually denoted by the variable f . The ordinary frequency is a measure of how often an object makes a complete cycle of the motion. The fact that $\omega = 2\pi f$ suggests that ω is also a frequency. Indeed, it is called the **angular frequency** of the motion. On a related note, the quantity $T = \frac{1}{f}$ is called the **period** of the motion and is the amount of time it takes for the object to complete one cycle of the motion. In the scenario of Example 8.1.5, the period of the motion is 24 hours, or one day.

The concepts of frequency and period help frame the equation $v = r\omega$ in a new light. That is, if ω is fixed, points which are farther from the center of rotation need to travel faster to maintain the same angular frequency since they have farther to travel to make one revolution in one period's time. The distance of the object to the center of rotation is the radius of the circle, r , and is the 'magnification factor' which relates ω and v . We will have more to say about frequencies and periods in Section 9.1. While we have exhaustively discussed velocities associated with circular motion, we have yet to discuss a more natural question: if an object is moving on a circular path of radius r with a fixed angular velocity (frequency) ω , what is the position of the object at time t ? The answer to this question is the very heart of Trigonometry and is answered in the next section.

8.1.2 EXERCISES

In Exercises 1 - 4, convert the angles into the DMS system. Round each of your answers to the nearest second.

1. 63.75° 2. 200.325° 3. -317.06° 4. 179.999°

In Exercises 5 - 8, convert the angles into decimal degrees. Round each of your answers to three decimal places.

5. $125^\circ 50'$ 6. $-32^\circ 10' 12''$ 7. $502^\circ 35'$ 8. $237^\circ 58' 43''$

In Exercises 9 - 28, graph the oriented angle in standard position. Classify each angle according to where its terminal side lies and then give two coterminal angles, one of which is positive and the other negative.

9. 330° 10. -135° 11. 120° 12. 405°
13. -270° 14. $\frac{5\pi}{6}$ 15. $-\frac{11\pi}{3}$ 16. $\frac{5\pi}{4}$
17. $\frac{3\pi}{4}$ 18. $-\frac{\pi}{3}$ 19. $\frac{7\pi}{2}$ 20. $\frac{\pi}{4}$
21. $-\frac{\pi}{2}$ 22. $\frac{7\pi}{6}$ 23. $-\frac{5\pi}{3}$ 24. 3π
25. -2π 26. $-\frac{\pi}{4}$ 27. $\frac{15\pi}{4}$ 28. $-\frac{13\pi}{6}$

In Exercises 29 - 36, convert the angle from degree measure into radian measure, giving the exact value in terms of π .

29. 0° 30. 240° 31. 135° 32. -270°
33. -315° 34. 150° 35. 45° 36. -225°

In Exercises 37 - 44, convert the angle from radian measure into degree measure.

37. π 38. $-\frac{2\pi}{3}$ 39. $\frac{7\pi}{6}$ 40. $\frac{11\pi}{6}$
41. $\frac{\pi}{3}$ 42. $\frac{5\pi}{3}$ 43. $-\frac{\pi}{6}$ 44. $\frac{\pi}{2}$

In Exercises 45 - 49, sketch the oriented arc on the Unit Circle which corresponds to the given real number.

45. $t = \frac{5\pi}{6}$ 46. $t = -\pi$ 47. $t = 6$ 48. $t = -2$ 49. $t = 12$

50. A yo-yo which is 2.25 inches in diameter spins at a rate of 4500 revolutions per minute. How fast is the edge of the yo-yo spinning in miles per hour? Round your answer to two decimal places.
51. How many revolutions per minute would the yo-yo in exercise 50 have to complete if the edge of the yo-yo is to be spinning at a rate of 42 miles per hour? Round your answer to two decimal places.
52. In the yo-yo trick 'Around the World,' the performer throws the yo-yo so it sweeps out a vertical circle whose radius is the yo-yo string. If the yo-yo string is 28 inches long and the yo-yo takes 3 seconds to complete one revolution of the circle, compute the speed of the yo-yo in miles per hour. Round your answer to two decimal places.
53. A computer hard drive contains a circular disk with diameter 2.5 inches and spins at a rate of 7200 RPM (revolutions per minute). Find the linear speed of a point on the edge of the disk in miles per hour.
54. A rock got stuck in the tread of my tire and when I was driving 70 miles per hour, the rock came loose and hit the inside of the wheel well of the car. How fast, in miles per hour, was the rock traveling when it came out of the tread? (The tire has a diameter of 23 inches.)
55. The Giant Wheel at Cedar Point is a circle with diameter 128 feet which sits on an 8 foot tall platform making its overall height is 136 feet. (Remember this from Exercise 17 in Section 0.10?) It completes two revolutions in 2 minutes and 7 seconds.²⁰ Assuming the riders are at the edge of the circle, how fast are they traveling in miles per hour?
56. Consider the circle of radius r pictured below with central angle θ , measured in radians, and subtended arc of length s . Prove that the area of the shaded sector is $A = \frac{1}{2}r^2\theta$.

(Hint: Use the proportion $\frac{A}{\text{area of the circle}} = \frac{s}{\text{circumference of the circle}}$.)

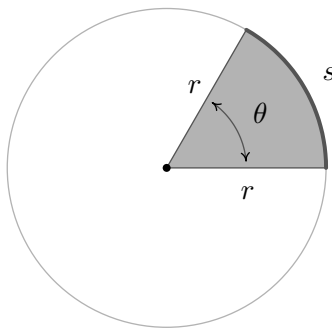

²⁰Source: [Cedar Point's webpage](#).

In Exercises 57 - 62, use the result of Exercise 56 to compute the areas of the circular sectors with the given central angles and radii.

57. $\theta = \frac{\pi}{6}, r = 12$

58. $\theta = \frac{5\pi}{4}, r = 100$

59. $\theta = 330^\circ, r = 9.3$

60. $\theta = \pi, r = 1$

61. $\theta = 240^\circ, r = 5$

62. $\theta = 1^\circ, r = 117$

63. Imagine a rope tied around the Earth at the equator. Show that you need to add only 2π feet of length to the rope in order to lift it one foot above the ground around the entire equator. (You do NOT need to know the radius of the Earth to show this.)
64. With the help of your classmates, look for a proof that π is indeed a constant.

8.1.3 ANSWERS

1. $63^\circ 45'$ 2. $200^\circ 19' 30''$ 3. $-317^\circ 3' 36''$ 4. $179^\circ 59' 56''$
 5. 125.833° 6. -32.17° 7. 502.583° 8. 237.979°
 9. 330° is a Quadrant IV angle
 coterminal with 690° and -30°

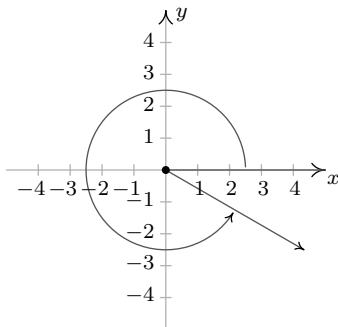

10. -135° is a Quadrant III angle
 coterminal with 225° and -495°

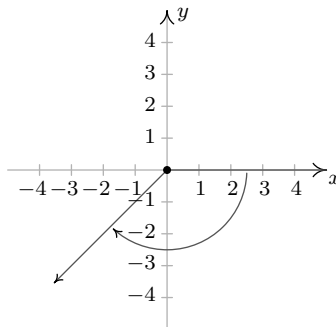

11. 120° is a Quadrant II angle
 coterminal with 480° and -240°

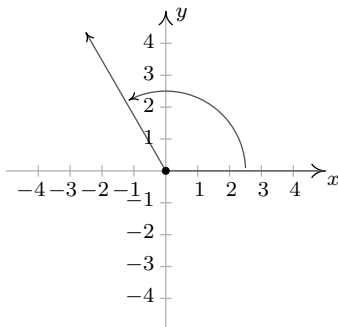

12. 405° is a Quadrant I angle
 coterminal with 45° and -315°

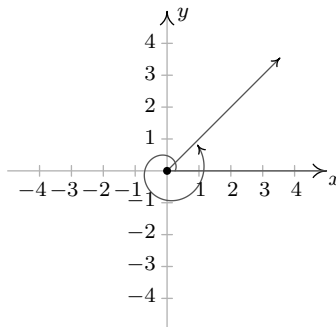

13. -270° lies on the positive y -axis
 coterminal with 90° and -630°

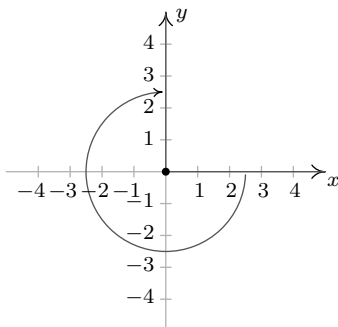

14. $\frac{5\pi}{6}$ is a Quadrant II angle
 coterminal with $\frac{17\pi}{6}$ and $-\frac{7\pi}{6}$

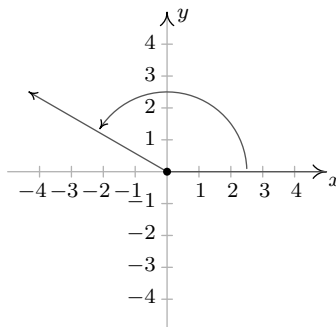

15. $-\frac{11\pi}{3}$ is a Quadrant I angle
coterminal with $\frac{\pi}{3}$ and $-\frac{5\pi}{3}$

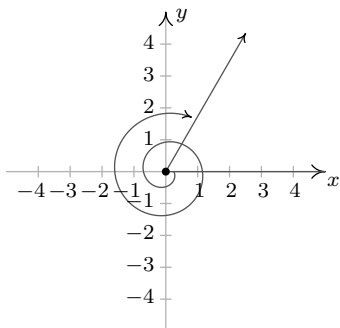

16. $\frac{5\pi}{4}$ is a Quadrant III angle
coterminal with $\frac{13\pi}{4}$ and $-\frac{3\pi}{4}$

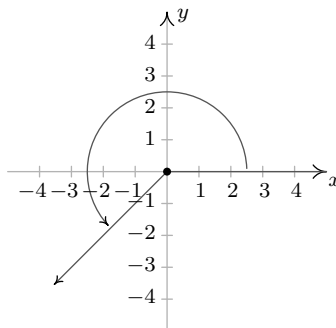

17. $\frac{3\pi}{4}$ is a Quadrant II angle
coterminal with $\frac{11\pi}{4}$ and $-\frac{5\pi}{4}$

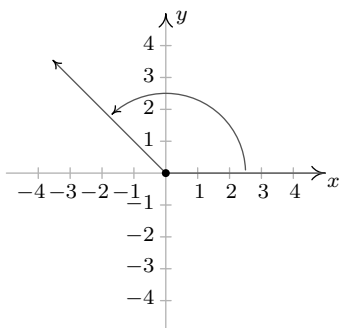

18. $-\frac{\pi}{3}$ is a Quadrant IV angle
coterminal with $\frac{5\pi}{3}$ and $-\frac{7\pi}{3}$

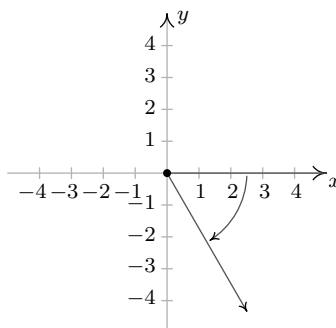

19. $\frac{7\pi}{2}$ lies on the negative y -axis
coterminal with $\frac{3\pi}{2}$ and $-\frac{\pi}{2}$

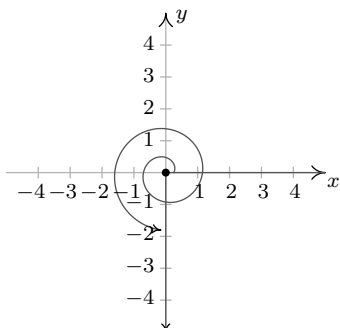

20. $\frac{\pi}{4}$ is a Quadrant I angle
coterminal with $\frac{9\pi}{4}$ and $-\frac{7\pi}{4}$

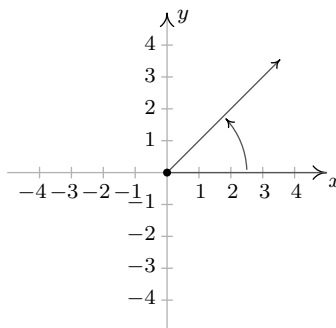

21. $-\frac{\pi}{2}$ lies on the negative y -axis
coterminal with $\frac{3\pi}{2}$ and $-\frac{5\pi}{2}$

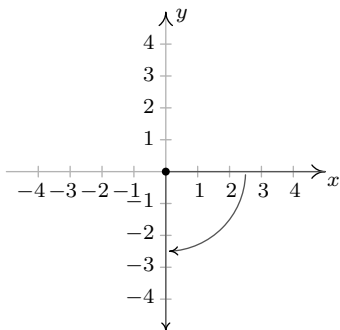

22. $\frac{7\pi}{6}$ is a Quadrant III angle
coterminal with $\frac{19\pi}{6}$ and $-\frac{5\pi}{6}$

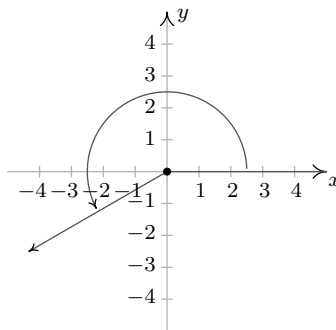

23. $-\frac{5\pi}{3}$ is a Quadrant I angle
coterminal with $\frac{\pi}{3}$ and $-\frac{11\pi}{3}$

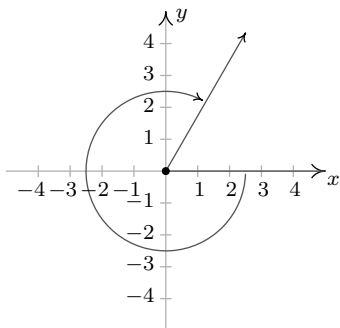

24. 3π lies on the negative x -axis
coterminal with π and $-\pi$

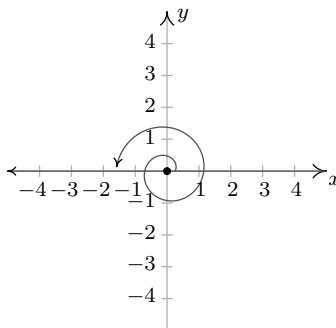

25. -2π lies on the positive x -axis
coterminal with 2π and -4π

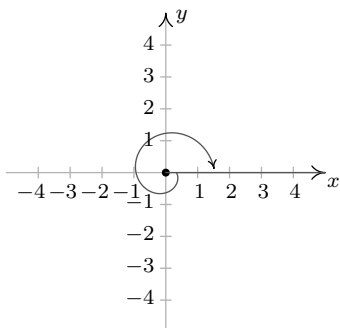

26. $-\frac{\pi}{4}$ is a Quadrant IV angle
coterminal with $\frac{7\pi}{4}$ and $-\frac{9\pi}{4}$

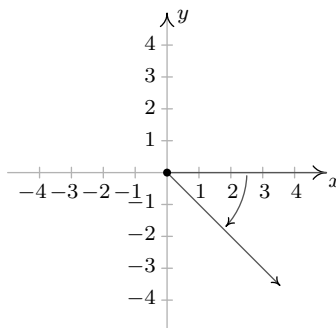

27. $\frac{15\pi}{4}$ is a Quadrant IV angle
coterminal with $\frac{7\pi}{4}$ and $-\frac{\pi}{4}$

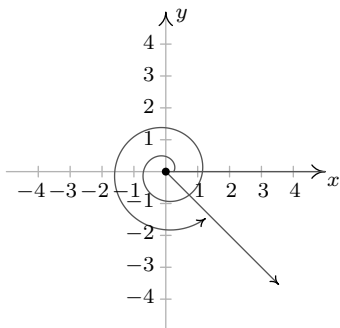

28. $-\frac{13\pi}{6}$ is a Quadrant IV angle
coterminal with $\frac{11\pi}{6}$ and $-\frac{\pi}{6}$

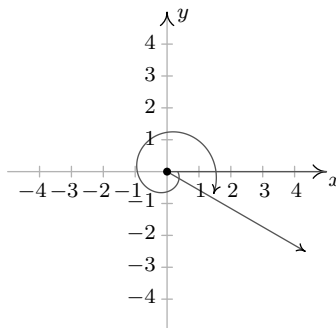

29. 0

30. $\frac{4\pi}{3}$

31. $\frac{3\pi}{4}$

32. $-\frac{3\pi}{2}$

33. $-\frac{7\pi}{4}$

34. $\frac{5\pi}{6}$

35. $\frac{\pi}{4}$

36. $-\frac{5\pi}{4}$

37. 180°

38. -120°

39. 210°

40. 330°

41. 60°

42. 300°

43. -30°

44. 90°

45. $t = \frac{5\pi}{6}$

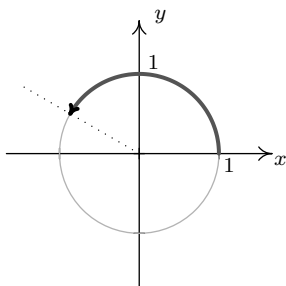

46. $t = -\pi$

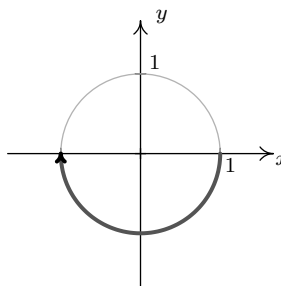

47. $t = 6$

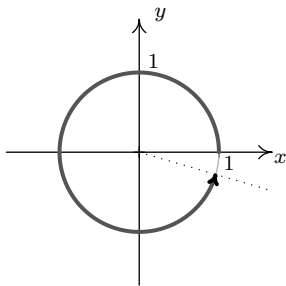

48. $t = -2$

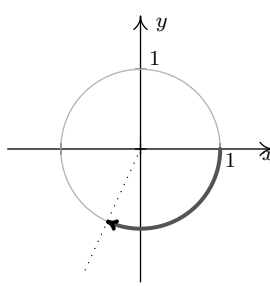

49. $t = 12$ (between 1 and 2 revolutions)

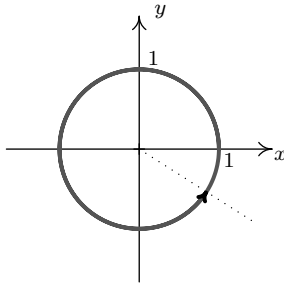

50. About 30.12 miles per hour
51. About 6274.52 revolutions per minute
52. About 3.33 miles per hour
53. About 53.55 miles per hour
54. 70 miles per hour
55. About 4.32 miles per hour
57. 12π square units
58. 6250π square units
59. $79.2825\pi \approx 249.07$ square units
60. $\frac{\pi}{2}$ square units
61. $\frac{50\pi}{3}$ square units
62. $38.025\pi \approx 119.46$ square units

8.2 THE UNIT CIRCLE: COSINE AND SINE

In Section 8.1.1, we introduced circular motion and derived a formula which describes the linear velocity of an object moving on a circular path at a constant angular velocity. One of the goals of this section is describe the *position* of such an object. To that end, consider an angle θ in standard position and let P denote the point where the terminal side of θ intersects the Unit Circle. By associating the point P with the angle θ , we are assigning a *position* on the Unit Circle to the angle θ . The x -coordinate of P is called the **cosine** of θ , written $\cos(\theta)$, while the y -coordinate of P is called the **sine** of θ , written $\sin(\theta)$.¹ The reader is encouraged to verify that these rules used to match an angle with its cosine and sine do, in fact, satisfy the definition of a function. That is, for each angle θ , there is only one associated value of $\cos(\theta)$ and only one associated value of $\sin(\theta)$.

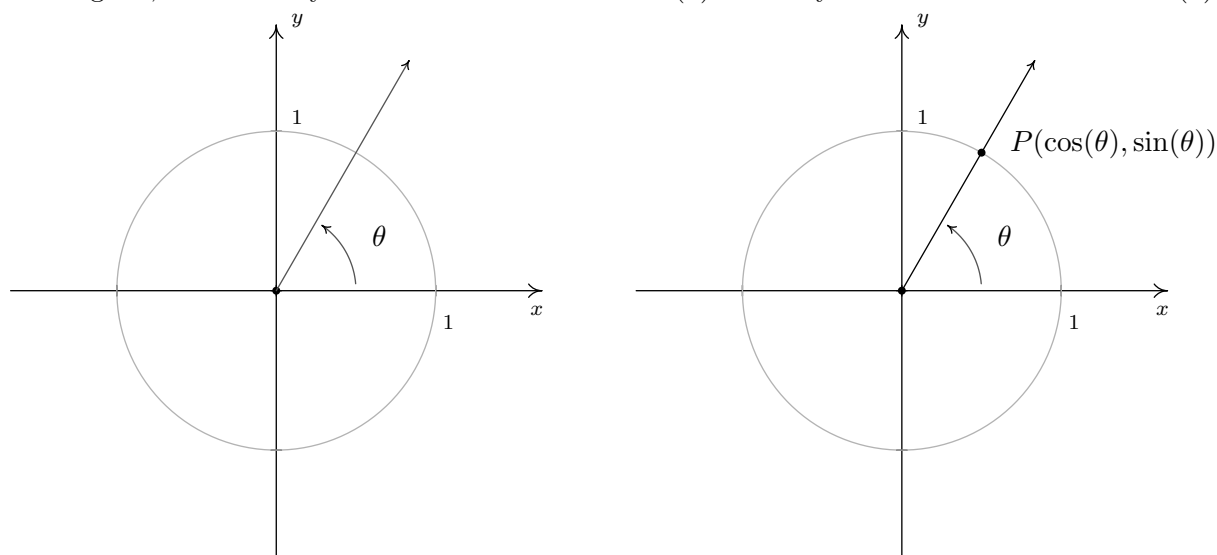

Example 8.2.1. Find the cosine and sine of the following angles.

1. $\theta = 270^\circ$
2. $\theta = -\pi$
3. $\theta = 45^\circ$
4. $\theta = \frac{\pi}{6}$
5. $\theta = 60^\circ$

Solution.

1. To find $\cos(270^\circ)$ and $\sin(270^\circ)$, we plot the angle $\theta = 270^\circ$ in standard position and find the point on the terminal side of θ which lies on the Unit Circle. Since 270° represents $\frac{3}{4}$ of a counter-clockwise revolution, the terminal side of θ lies along the negative y -axis. Hence, the point we seek is $(0, -1)$ so that $\cos(270^\circ) = 0$ and $\sin(270^\circ) = -1$.
2. The angle $\theta = -\pi$ represents one half of a clockwise revolution so its terminal side lies on the negative x -axis. The point on the Unit Circle that lies on the negative x -axis is $(-1, 0)$ which means $\cos(-\pi) = -1$ and $\sin(-\pi) = 0$.

¹The etymology of the name ‘sine’ is quite colorful, and the interested reader is invited to research it; the ‘co’ in ‘cosine’ is explained in Section 8.4.

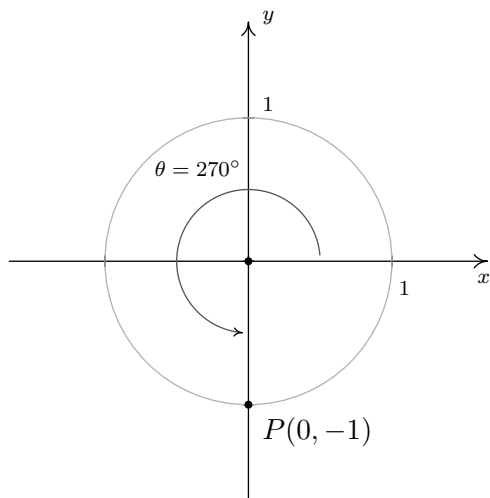
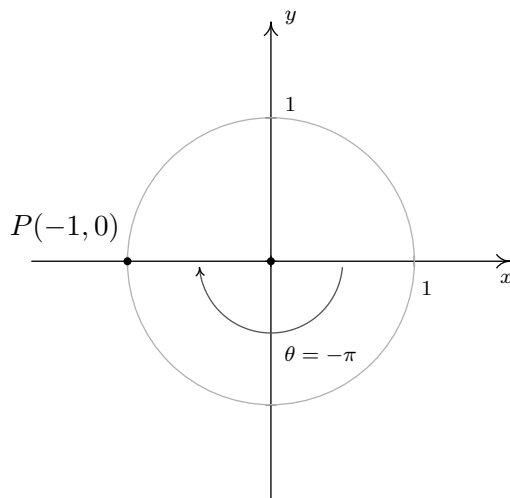
Finding $\cos(270^\circ)$ and $\sin(270^\circ)$ Finding $\cos(-\pi)$ and $\sin(-\pi)$

3. When we sketch $\theta = 45^\circ$ in standard position, we see that its terminal does not lie along any of the coordinate axes which makes our job of finding the cosine and sine values a bit more difficult. Let $P(x, y)$ denote the point on the terminal side of θ which lies on the Unit Circle. By definition, $x = \cos(45^\circ)$ and $y = \sin(45^\circ)$. If we drop a perpendicular line segment from P to the x -axis, we obtain a $45^\circ - 45^\circ - 90^\circ$ right triangle whose legs have lengths x and y units. From Geometry,² we get $y = x$. Since $P(x, y)$ lies on the Unit Circle, we have $x^2 + y^2 = 1$. Substituting $y = x$ into this equation yields $2x^2 = 1$, or $x = \pm\sqrt{\frac{1}{2}} = \pm\frac{\sqrt{2}}{2}$. Since $P(x, y)$ lies in the first quadrant, $x > 0$, so $x = \cos(45^\circ) = \frac{\sqrt{2}}{2}$ and with $y = x$ we have $y = \sin(45^\circ) = \frac{\sqrt{2}}{2}$.

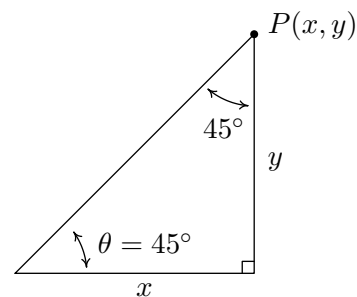
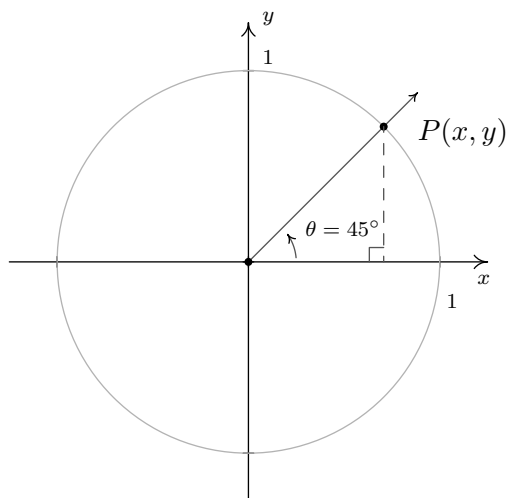

²Can you show this?

4. As before, the terminal side of $\theta = \frac{\pi}{6}$ does not lie on any of the coordinate axes, so we proceed using a triangle approach. Letting $P(x, y)$ denote the point on the terminal side of θ which lies on the Unit Circle, we drop a perpendicular line segment from P to the x -axis to form a $30^\circ - 60^\circ - 90^\circ$ right triangle. After a bit of Geometry³ we find $y = \frac{1}{2}$ so $\sin\left(\frac{\pi}{6}\right) = \frac{1}{2}$. Since $P(x, y)$ lies on the Unit Circle, we substitute $y = \frac{1}{2}$ into $x^2 + y^2 = 1$ to get $x^2 = \frac{3}{4}$, or $x = \pm\frac{\sqrt{3}}{2}$. Here, $x > 0$ so $x = \cos\left(\frac{\pi}{6}\right) = \frac{\sqrt{3}}{2}$.

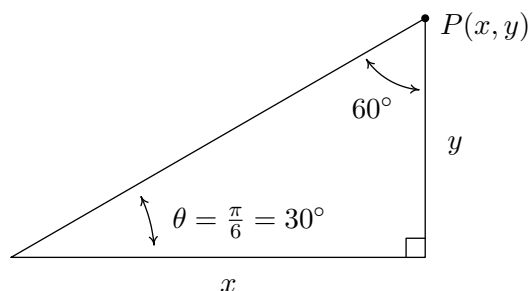
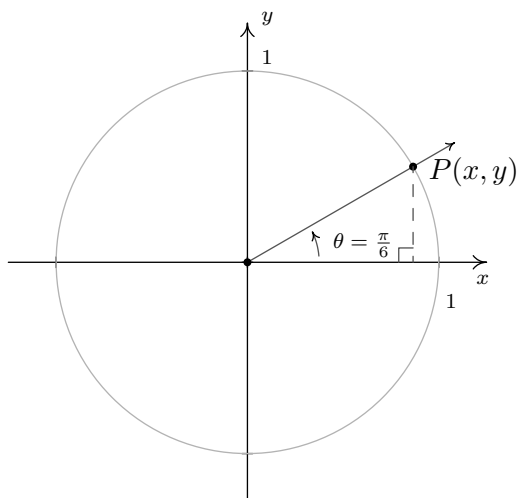

5. Plotting $\theta = 60^\circ$ in standard position, we find it is not a quadrantal angle and set about using a triangle approach. Once again, we get a $30^\circ - 60^\circ - 90^\circ$ right triangle and, after the usual computations, find $x = \cos(60^\circ) = \frac{1}{2}$ and $y = \sin(60^\circ) = \frac{\sqrt{3}}{2}$.

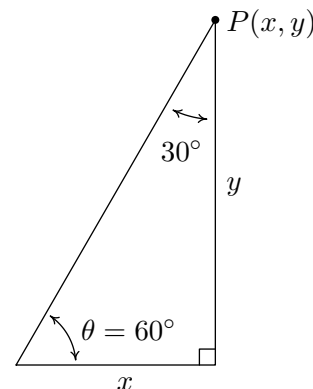
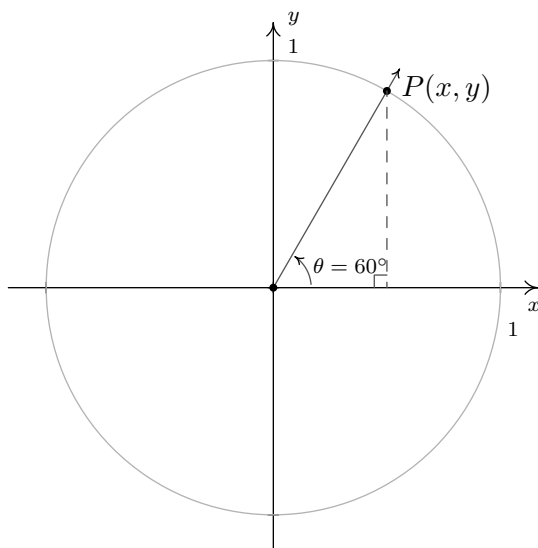

□

³Again, can you show this?

In Example 8.2.1, it was quite easy to find the cosine and sine of the quadrantal angles, but for non-quadrantal angles, the task was much more involved. In these latter cases, we made good use of the fact that the point $P(x, y) = (\cos(\theta), \sin(\theta))$ lies on the Unit Circle, $x^2 + y^2 = 1$. If we substitute $x = \cos(\theta)$ and $y = \sin(\theta)$ into $x^2 + y^2 = 1$, we get $(\cos(\theta))^2 + (\sin(\theta))^2 = 1$. An unfortunate⁴ convention, which the authors are compelled to perpetuate, is to write $(\cos(\theta))^2$ as $\cos^2(\theta)$ and $(\sin(\theta))^2$ as $\sin^2(\theta)$. Rewriting the identity using this convention results in the following theorem, which is without a doubt one of the most important results in Trigonometry.

Theorem 8.1. The Pythagorean Identity: For any angle θ , $\cos^2(\theta) + \sin^2(\theta) = 1$.

The moniker ‘Pythagorean’ brings to mind the Pythagorean Theorem, from which both the Distance Formula and the equation for a circle are ultimately derived.⁵ The word ‘Identity’ reminds us that, regardless of the angle θ , the equation in Theorem 8.1 is always true. If one of $\cos(\theta)$ or $\sin(\theta)$ is known, Theorem 8.1 can be used to determine the other, up to a (\pm) sign. If, in addition, we know where the terminal side of θ lies when in standard position, then we can remove the ambiguity of the (\pm) and completely determine the missing value as the next example illustrates.

Example 8.2.2. Using the given information about θ , find the indicated value.

1. If θ is a Quadrant II angle with $\sin(\theta) = \frac{3}{5}$, find $\cos(\theta)$.
2. If $\pi < \theta < \frac{3\pi}{2}$ with $\cos(\theta) = -\frac{\sqrt{5}}{5}$, find $\sin(\theta)$.
3. If $\sin(\theta) = 1$, find $\cos(\theta)$.

Solution.

1. When we substitute $\sin(\theta) = \frac{3}{5}$ into The Pythagorean Identity, $\cos^2(\theta) + \sin^2(\theta) = 1$, we obtain $\cos^2(\theta) + \frac{9}{25} = 1$. Solving, we find $\cos(\theta) = \pm\frac{4}{5}$. Since θ is a Quadrant II angle, its terminal side, when plotted in standard position, lies in Quadrant II. Since the x -coordinates are negative in Quadrant II, $\cos(\theta)$ is too. Hence, $\cos(\theta) = -\frac{4}{5}$.
2. Substituting $\cos(\theta) = -\frac{\sqrt{5}}{5}$ into $\cos^2(\theta) + \sin^2(\theta) = 1$ gives $\sin(\theta) = \pm\frac{2}{\sqrt{5}} = \pm\frac{2\sqrt{5}}{5}$. Since we are given that $\pi < \theta < \frac{3\pi}{2}$, we know θ is a Quadrant III angle. Hence both its sine and cosine are negative and we conclude $\sin(\theta) = -\frac{2\sqrt{5}}{5}$.
3. When we substitute $\sin(\theta) = 1$ into $\cos^2(\theta) + \sin^2(\theta) = 1$, we find $\cos(\theta) = 0$. □

Another tool which helps immensely in determining cosines and sines of angles is the symmetry inherent in the Unit Circle. Suppose, for instance, we wish to know the cosine and sine of $\theta = \frac{5\pi}{6}$. We plot θ in standard position below and, as usual, let $P(x, y)$ denote the point on the terminal side of θ which lies on the Unit Circle. Note that the terminal side of θ lies $\frac{\pi}{6}$ radians short of one half revolution. In Example 8.2.1, we determined that $\cos(\frac{\pi}{6}) = \frac{\sqrt{3}}{2}$ and $\sin(\frac{\pi}{6}) = \frac{1}{2}$. This means

⁴This is unfortunate from a ‘function notation’ perspective. See Section 8.6.

⁵See Sections 1.1 and 0.10 for details.

that the point on the terminal side of the angle $\frac{\pi}{6}$, when plotted in standard position, is $(\frac{\sqrt{3}}{2}, \frac{1}{2})$. From the figure below, it is clear that the point $P(x, y)$ we seek can be obtained by reflecting that point about the y -axis. Hence, $\cos(\frac{5\pi}{6}) = -\frac{\sqrt{3}}{2}$ and $\sin(\frac{5\pi}{6}) = \frac{1}{2}$.

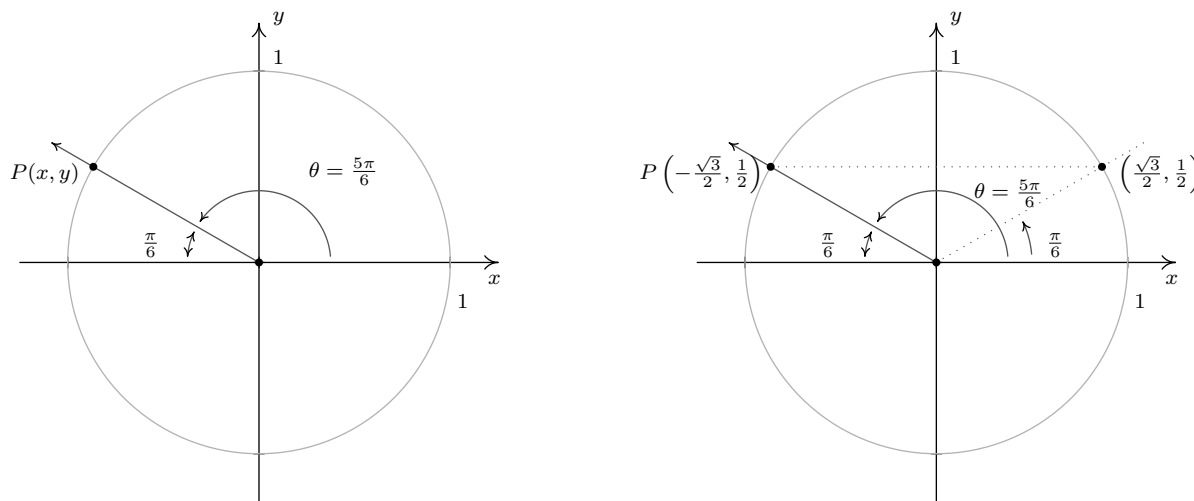

In the above scenario, the angle $\frac{\pi}{6}$ is called the **reference angle** for the angle $\frac{5\pi}{6}$. In general, for a non-quadrantal angle θ , the reference angle for θ (usually denoted α) is the *acute* angle made between the terminal side of θ and the x -axis. If θ is a Quadrant I or IV angle, α is the angle between the terminal side of θ and the *positive* x -axis; if θ is a Quadrant II or III angle, α is the angle between the terminal side of θ and the *negative* x -axis. If we let P denote the point $(\cos(\theta), \sin(\theta))$, then P lies on the Unit Circle. Since the Unit Circle possesses symmetry with respect to the x -axis, y -axis and origin, regardless of where the terminal side of θ lies, there is a point Q symmetric with P which determines θ 's reference angle, α as seen below.

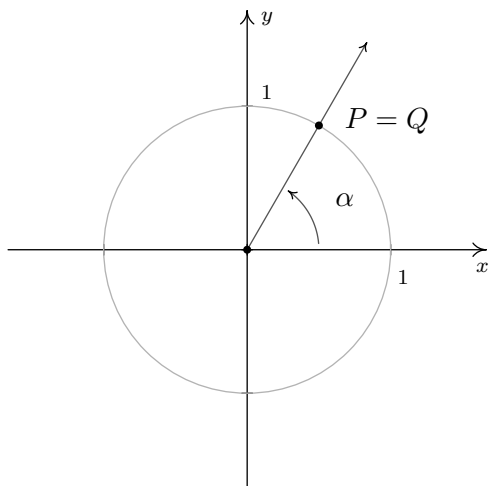
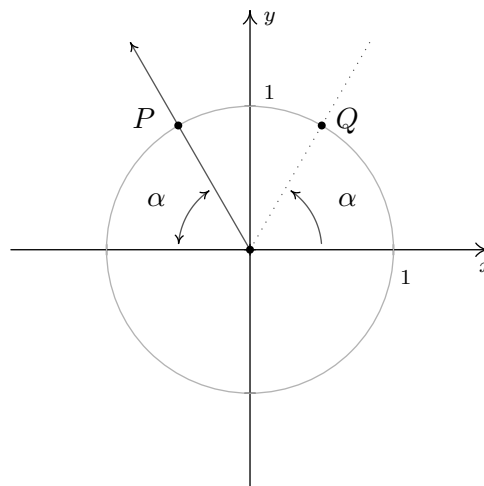
Reference angle α for a Quadrant I angleReference angle α for a Quadrant II angle

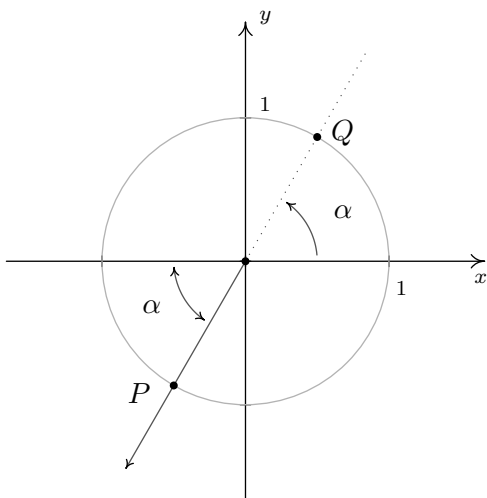
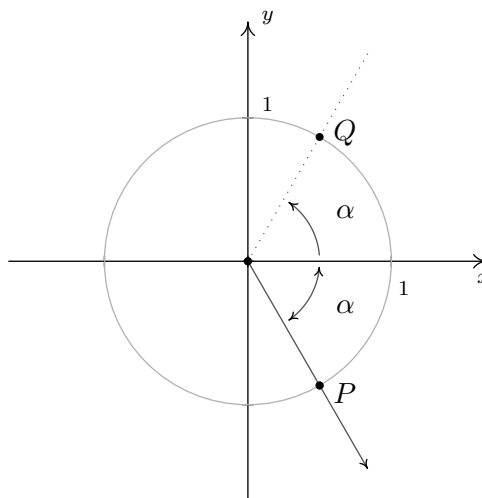
Reference angle α for a Quadrant III angleReference angle α for a Quadrant IV angle

We have just outlined the proof of the following theorem.

Theorem 8.2. Reference Angle Theorem. Suppose α is the reference angle for θ . Then $\cos(\theta) = \pm \cos(\alpha)$ and $\sin(\theta) = \pm \sin(\alpha)$, where the choice of the (\pm) depends on the quadrant in which the terminal side of θ lies.

In light of Theorem 8.2, it pays to know the cosine and sine values for certain common angles. In the table below, we summarize the values which we consider essential and must be memorized.

Cosine and Sine Values of Common Angles

θ (degrees)	θ (radians)	$\cos(\theta)$	$\sin(\theta)$
0°	0	1	0
30°	$\frac{\pi}{6}$	$\frac{\sqrt{3}}{2}$	$\frac{1}{2}$
45°	$\frac{\pi}{4}$	$\frac{\sqrt{2}}{2}$	$\frac{\sqrt{2}}{2}$
60°	$\frac{\pi}{3}$	$\frac{1}{2}$	$\frac{\sqrt{3}}{2}$
90°	$\frac{\pi}{2}$	0	1

Example 8.2.3. Find the cosine and sine of the following angles.

1. $\theta = 225^\circ$

2. $\theta = \frac{11\pi}{6}$

3. $\theta = -\frac{5\pi}{4}$

4. $\theta = \frac{7\pi}{3}$

Solution.

1. We begin by plotting $\theta = 225^\circ$ in standard position and find its terminal side overshoots the negative x -axis to land in Quadrant III. Hence, we obtain θ 's reference angle α by subtracting: $\alpha = \theta - 180^\circ = 225^\circ - 180^\circ = 45^\circ$. Since θ is a Quadrant III angle, both $\cos(\theta) < 0$ and

$\sin(\theta) < 0$. The Reference Angle Theorem yields: $\cos(225^\circ) = -\cos(45^\circ) = -\frac{\sqrt{2}}{2}$ and $\sin(225^\circ) = -\sin(45^\circ) = -\frac{\sqrt{2}}{2}$.

2. The terminal side of $\theta = \frac{11\pi}{6}$, when plotted in standard position, lies in Quadrant IV, just shy of the positive x -axis. To find θ 's reference angle α , we subtract: $\alpha = 2\pi - \theta = 2\pi - \frac{11\pi}{6} = \frac{\pi}{6}$. Since θ is a Quadrant IV angle, $\cos(\theta) > 0$ and $\sin(\theta) < 0$, so the Reference Angle Theorem gives: $\cos\left(\frac{11\pi}{6}\right) = \cos\left(\frac{\pi}{6}\right) = \frac{\sqrt{3}}{2}$ and $\sin\left(\frac{11\pi}{6}\right) = -\sin\left(\frac{\pi}{6}\right) = -\frac{1}{2}$.

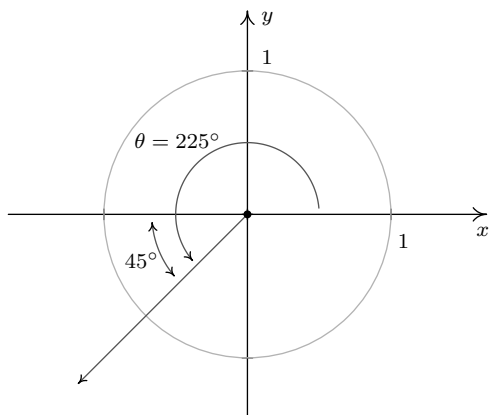
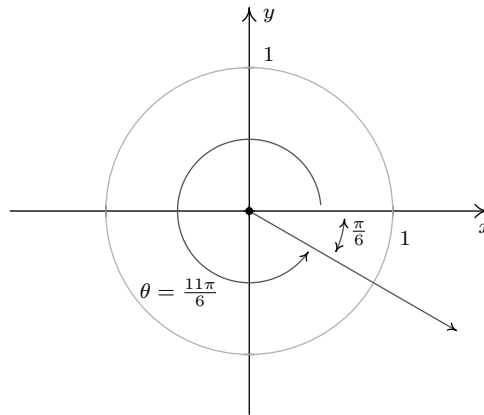
Finding $\cos(225^\circ)$ and $\sin(225^\circ)$ Finding $\cos\left(\frac{11\pi}{6}\right)$ and $\sin\left(\frac{11\pi}{6}\right)$

3. To plot $\theta = -\frac{5\pi}{4}$, we rotate *clockwise* an angle of $\frac{5\pi}{4}$ from the positive x -axis. The terminal side of θ , therefore, lies in Quadrant II making an angle of $\alpha = \frac{5\pi}{4} - \pi = \frac{\pi}{4}$ radians with respect to the negative x -axis. Since θ is a Quadrant II angle, the Reference Angle Theorem gives: $\cos\left(-\frac{5\pi}{4}\right) = -\cos\left(\frac{\pi}{4}\right) = -\frac{\sqrt{2}}{2}$ and $\sin\left(-\frac{5\pi}{4}\right) = \sin\left(\frac{\pi}{4}\right) = \frac{\sqrt{2}}{2}$.
4. Since the angle $\theta = \frac{7\pi}{3}$ measures more than $2\pi = \frac{6\pi}{3}$, we find the terminal side of θ by rotating one full revolution followed by an additional $\alpha = \frac{7\pi}{3} - 2\pi = \frac{\pi}{3}$ radians. Since θ and α are coterminal, $\cos\left(\frac{7\pi}{3}\right) = \cos\left(\frac{\pi}{3}\right) = \frac{1}{2}$ and $\sin\left(\frac{7\pi}{3}\right) = \sin\left(\frac{\pi}{3}\right) = \frac{\sqrt{3}}{2}$.

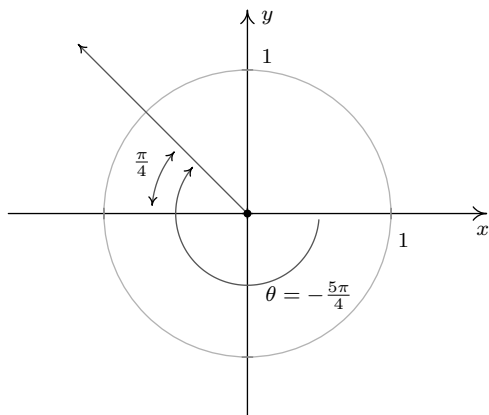
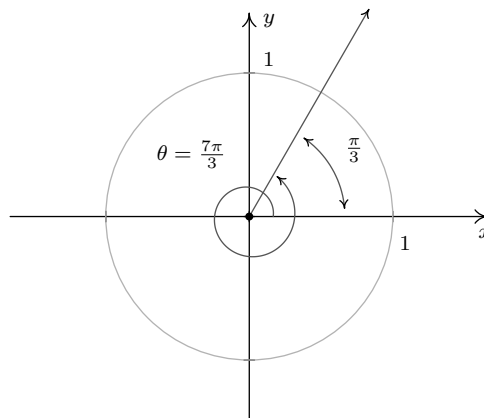
Finding $\cos\left(-\frac{5\pi}{4}\right)$ and $\sin\left(-\frac{5\pi}{4}\right)$ Finding $\cos\left(\frac{7\pi}{3}\right)$ and $\sin\left(\frac{7\pi}{3}\right)$

□

The reader may have noticed that when expressed in radian measure, the reference angle for a non-quadrantal angle is easy to spot. Reduced fraction multiples of π with a denominator of 6 have $\frac{\pi}{6}$ as a reference angle, those with a denominator of 4 have $\frac{\pi}{4}$ as their reference angle, and those with a denominator of 3 have $\frac{\pi}{3}$ as their reference angle.⁶ The Reference Angle Theorem in conjunction with the table of cosine and sine values on Page 690 can be used to generate the following figure, which the authors feel should be committed to memory.

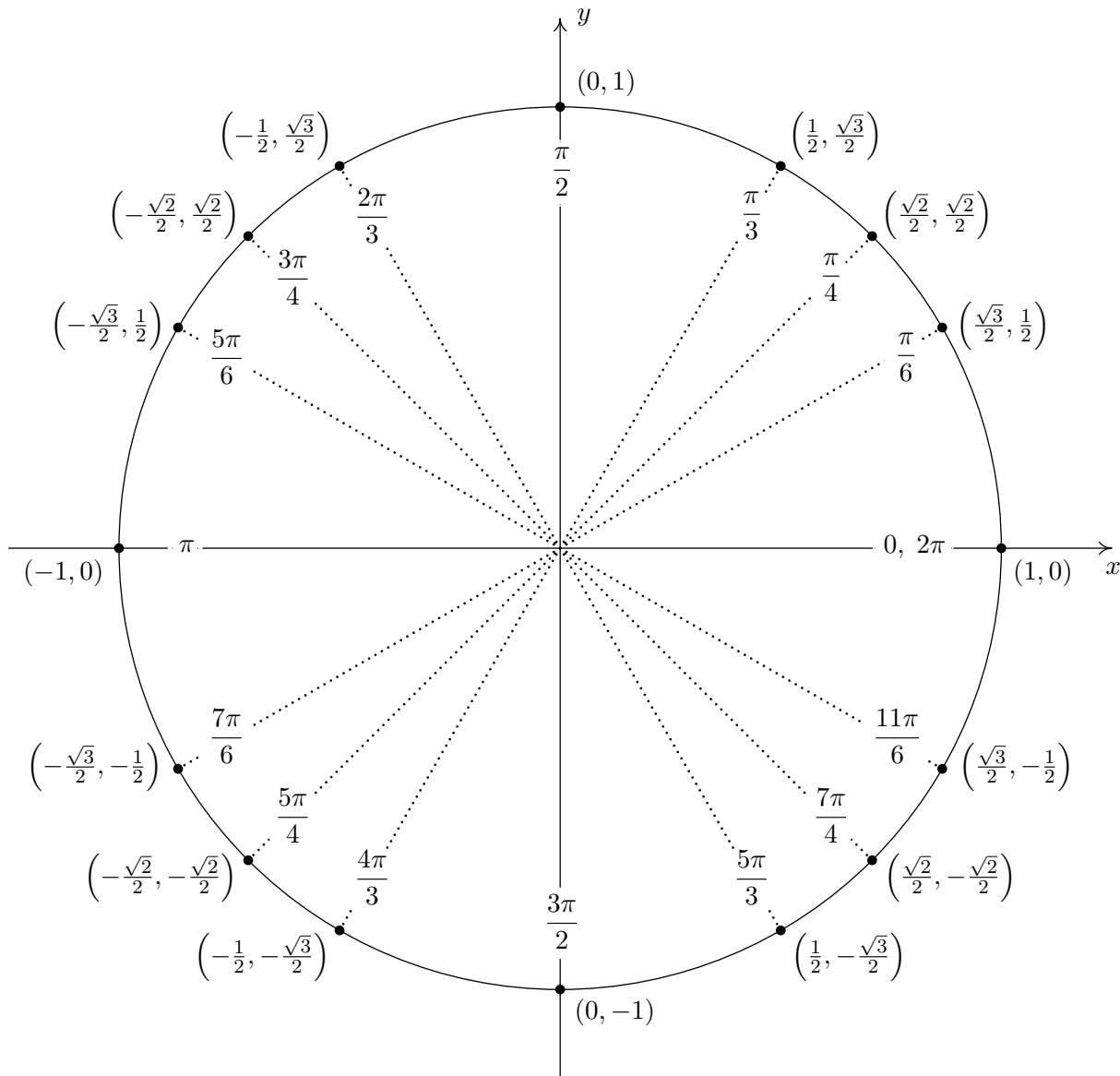

Important Points on the Unit Circle

⁶For once, we have something convenient about using radian measure in contrast to the abstract theoretical nonsense about using them as a 'natural' way to match oriented angles with real numbers!

The next example summarizes all of the important ideas discussed thus far in the section.

Example 8.2.4. Suppose α is an acute angle with $\cos(\alpha) = \frac{5}{13}$.

1. Find $\sin(\alpha)$ and use this to plot α in standard position.
2. Find the sine and cosine of the following angles:

$$(a) \theta = \pi + \alpha \qquad (b) \theta = 2\pi - \alpha \qquad (c) \theta = 3\pi - \alpha \qquad (d) \theta = \frac{\pi}{2} + \alpha$$

Solution.

1. Proceeding as in Example 8.2.2, we substitute $\cos(\alpha) = \frac{5}{13}$ into $\cos^2(\alpha) + \sin^2(\alpha) = 1$ and find $\sin(\alpha) = \pm \frac{12}{13}$. Since α is an acute (and therefore Quadrant I) angle, $\sin(\alpha)$ is positive. Hence, $\sin(\alpha) = \frac{12}{13}$. To plot α in standard position, we begin our rotation on the positive x -axis to the ray which contains the point $(\cos(\alpha), \sin(\alpha)) = (\frac{5}{13}, \frac{12}{13})$.

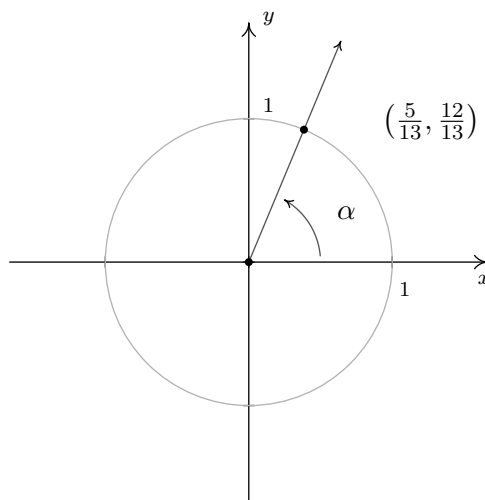

Sketching α

2. (a) To find the cosine and sine of $\theta = \pi + \alpha$, we first plot θ in standard position. We can imagine the sum of the angles $\pi + \alpha$ as a sequence of two rotations: a rotation of π radians followed by a rotation of α radians.⁷ We see that α is the reference angle for θ , so by The Reference Angle Theorem, $\cos(\theta) = \pm \cos(\alpha) = \pm \frac{5}{13}$ and $\sin(\theta) = \pm \sin(\alpha) = \pm \frac{12}{13}$. Since the terminal side of θ falls in Quadrant III, both $\cos(\theta)$ and $\sin(\theta)$ are negative, hence, $\cos(\theta) = -\frac{5}{13}$ and $\sin(\theta) = -\frac{12}{13}$.

⁷Since $\pi + \alpha = \alpha + \pi$, θ may be plotted by reversing the order of rotations given here. You should do this.

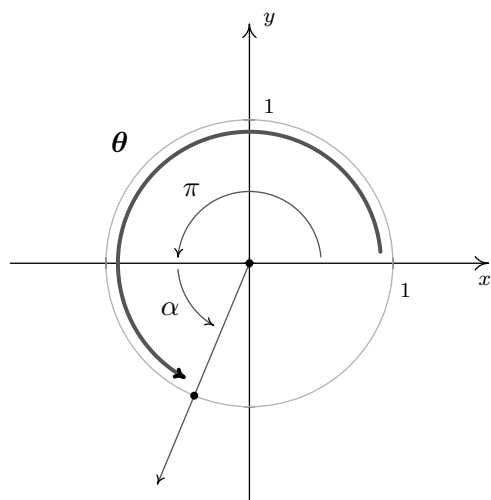
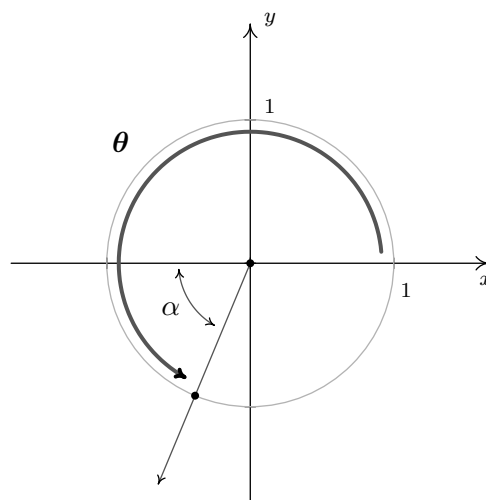
Visualizing $\theta = \pi + \alpha$  θ has reference angle α

- (b) Rewriting $\theta = 2\pi - \alpha$ as $\theta = 2\pi + (-\alpha)$, we can plot θ by visualizing one complete revolution counter-clockwise followed by a *clockwise* revolution, or ‘backing up,’ of α radians. We see that α is θ ’s reference angle, and since θ is a Quadrant IV angle, the Reference Angle Theorem gives: $\cos(\theta) = \frac{5}{13}$ and $\sin(\theta) = -\frac{12}{13}$.

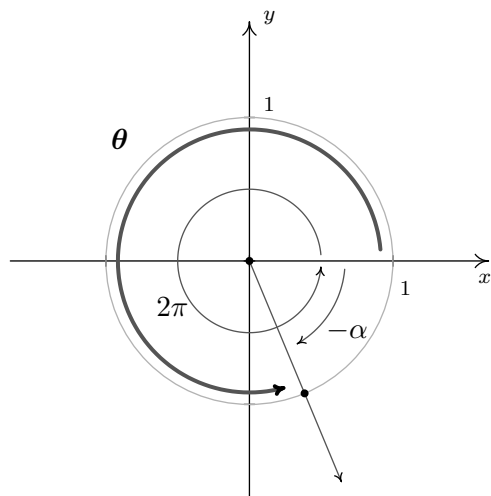
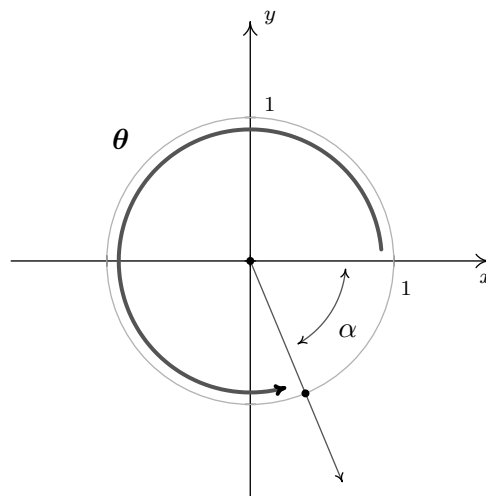
Visualizing $\theta = 2\pi - \alpha$  θ has reference angle α

- (c) Taking a cue from the previous problem, we rewrite $\theta = 3\pi - \alpha$ as $\theta = 3\pi + (-\alpha)$. The angle 3π represents one and a half revolutions counter-clockwise, so that when we ‘back up’ α radians, we end up in Quadrant II. Using the Reference Angle Theorem, we get $\cos(\theta) = -\frac{5}{13}$ and $\sin(\theta) = \frac{12}{13}$.

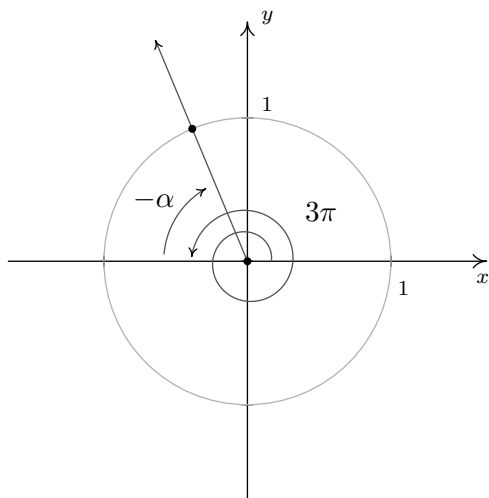

Visualizing $3\pi - \alpha$

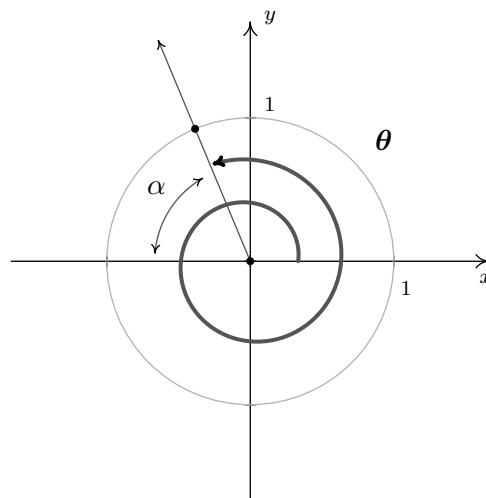

θ has reference angle α

- (d) To plot $\theta = \frac{\pi}{2} + \alpha$, we first rotate $\frac{\pi}{2}$ radians and follow up with α radians. The reference angle here is *not* α , so The Reference Angle Theorem is not immediately applicable. (It's important that you see why this is the case. Take a moment to think about this before reading on.) Let $Q(x, y)$ be the point on the terminal side of θ which lies on the Unit Circle so that $x = \cos(\theta)$ and $y = \sin(\theta)$. Once we graph α in standard position, we use the fact that equal angles subtend equal chords to show that the dotted lines in the figure below are equal. Hence, $x = \cos(\theta) = -\frac{12}{13}$. Similarly, we find $y = \sin(\theta) = \frac{5}{13}$.

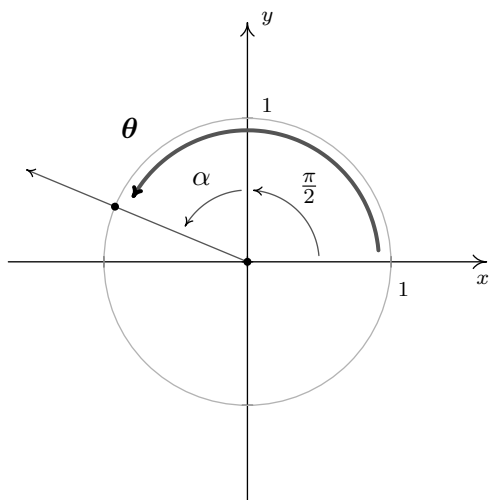

Visualizing $\theta = \frac{\pi}{2} + \alpha$

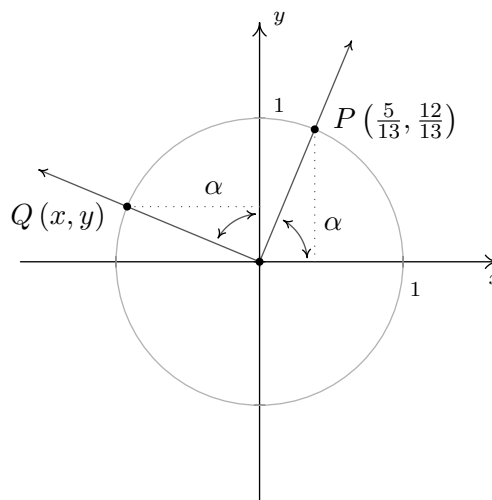

Using symmetry to determine $Q(x, y)$

□

Our next example asks us to solve some very basic trigonometric equations.⁸

Example 8.2.5. Find all of the angles which satisfy the given equation.

1. $\cos(\theta) = \frac{1}{2}$

2. $\sin(\theta) = -\frac{1}{2}$

3. $\cos(\theta) = 0$.

Solution. Since there is no context in the problem to indicate whether to use degrees or radians, we will default to using radian measure in our answers to each of these problems. This choice will be justified later in the text when we study what is known as Analytic Trigonometry. In those sections to come, radian measure will be the *only* appropriate angle measure so it is worth the time to become “fluent in radians” now.

1. If $\cos(\theta) = \frac{1}{2}$, then the terminal side of θ , when plotted in standard position, intersects the Unit Circle at $x = \frac{1}{2}$. This means θ is a Quadrant I or IV angle with reference angle $\frac{\pi}{3}$.

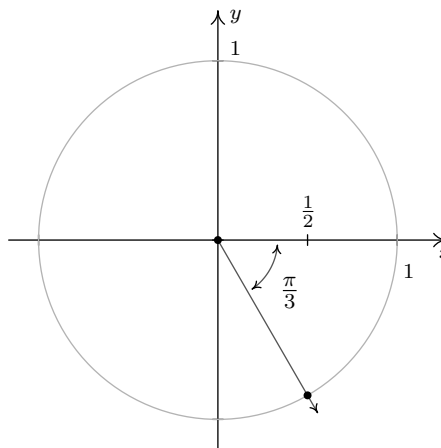
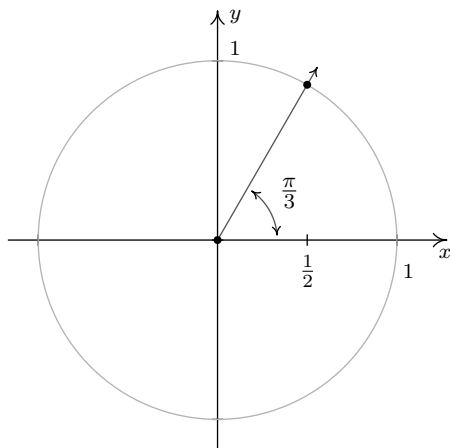

One solution in Quadrant I is $\theta = \frac{\pi}{3}$, and since all other Quadrant I solutions must be coterminal with $\frac{\pi}{3}$, we find $\theta = \frac{\pi}{3} + 2\pi k$ for integers k .⁹ Proceeding similarly for the Quadrant IV case, we find the solution to $\cos(\theta) = \frac{1}{2}$ here is $\frac{5\pi}{3}$, so our answer in this Quadrant is $\theta = \frac{5\pi}{3} + 2\pi k$ for integers k .

2. If $\sin(\theta) = -\frac{1}{2}$, then when θ is plotted in standard position, its terminal side intersects the Unit Circle at $y = -\frac{1}{2}$. From this, we determine θ is a Quadrant III or Quadrant IV angle with reference angle $\frac{\pi}{6}$.

⁸We will study trigonometric equations more formally in Section 8.7. Enjoy these relatively straightforward exercises while they last!

⁹Recall in Section 8.1, two angles in radian measure are coterminal if and only if they differ by an integer multiple of 2π . Hence to describe all angles coterminal with a given angle, we add $2\pi k$ for integers $k = 0, \pm 1, \pm 2, \dots$

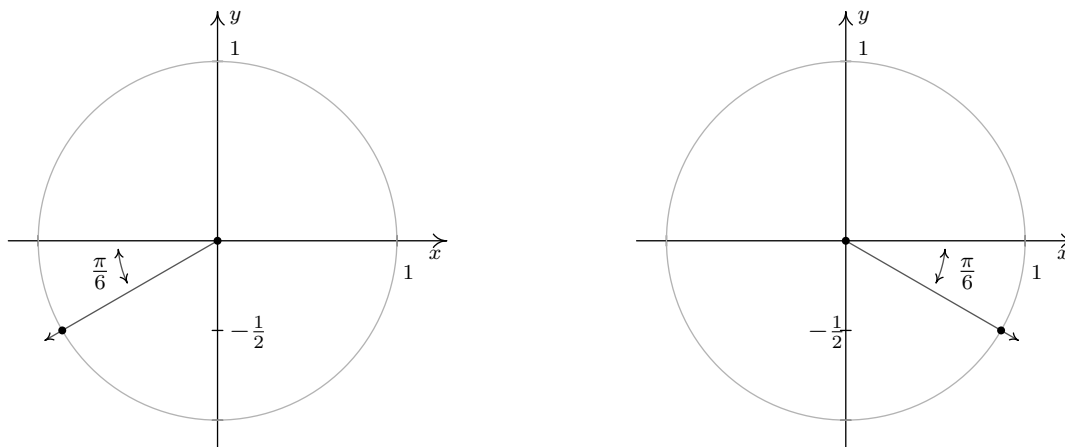

In Quadrant III, one solution is $\frac{7\pi}{6}$, so we capture all Quadrant III solutions by adding integer multiples of 2π : $\theta = \frac{7\pi}{6} + 2\pi k$. In Quadrant IV, one solution is $\frac{11\pi}{6}$ so all the solutions here are of the form $\theta = \frac{11\pi}{6} + 2\pi k$ for integers k .

3. The angles with $\cos(\theta) = 0$ are quadrantal angles whose terminal sides, when plotted in standard position, lie along the y -axis.

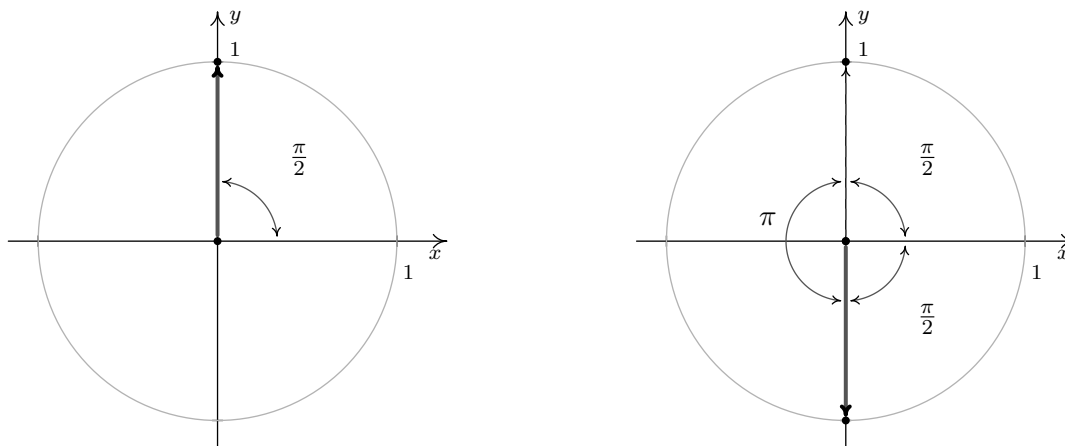

While, technically speaking, $\frac{\pi}{2}$ isn't a reference angle we can nonetheless use it to find our answers. If we follow the procedure set forth in the previous examples, we find $\theta = \frac{\pi}{2} + 2\pi k$ and $\theta = \frac{3\pi}{2} + 2\pi k$ for integers, k . While this solution is correct, it can be shortened to $\theta = \frac{\pi}{2} + \pi k$ for integers k . (Can you see why this works from the diagram?) \square

One of the key items to take from Example 8.2.5 is that, in general, solutions to trigonometric equations consist of infinitely many answers. To get a feel for these answers, the reader is encouraged to follow our mantra 'When in doubt, write it out!' This is especially important when checking answers to the exercises. For example, another Quadrant IV solution to $\sin(\theta) = -\frac{1}{2}$ is $\theta = -\frac{\pi}{6}$. Hence, the family of Quadrant IV answers to number 2 above could just have easily been written $\theta = -\frac{\pi}{6} + 2\pi k$ for integers k . While on the surface, this family may look different than the stated

solution of $\theta = \frac{11\pi}{6} + 2\pi k$ for integers k , we leave it to the reader to show they represent the same list of angles.

8.2.1 BEYOND THE UNIT CIRCLE

We began the section with a quest to describe the position of a particle experiencing circular motion. In defining the cosine and sine functions, we assigned to each angle a position on the *Unit Circle*. In this subsection, we broaden our scope to include circles of radius r centered at the origin. Consider for the moment the *acute* angle θ drawn below in standard position. Let $Q(x, y)$ be the point on the terminal side of θ which lies on the circle $x^2 + y^2 = r^2$, and let $P(x', y')$ be the point on the terminal side of θ which lies on the Unit Circle. Now consider dropping perpendiculars from P and Q to create two right triangles, $\triangle OPA$ and $\triangle OQB$. These triangles are similar,¹⁰ thus it follows that $\frac{x}{x'} = \frac{r}{1} = r$, so $x = rx'$ and, similarly, we find $y = ry'$. Since, by definition, $x' = \cos(\theta)$ and $y' = \sin(\theta)$, we get the coordinates of Q to be $x = r \cos(\theta)$ and $y = r \sin(\theta)$. By reflecting these points through the x -axis, y -axis and origin, we obtain the result for all non-quadrantal angles θ , and we leave it to the reader to verify these formulas hold for the quadrantal angles.

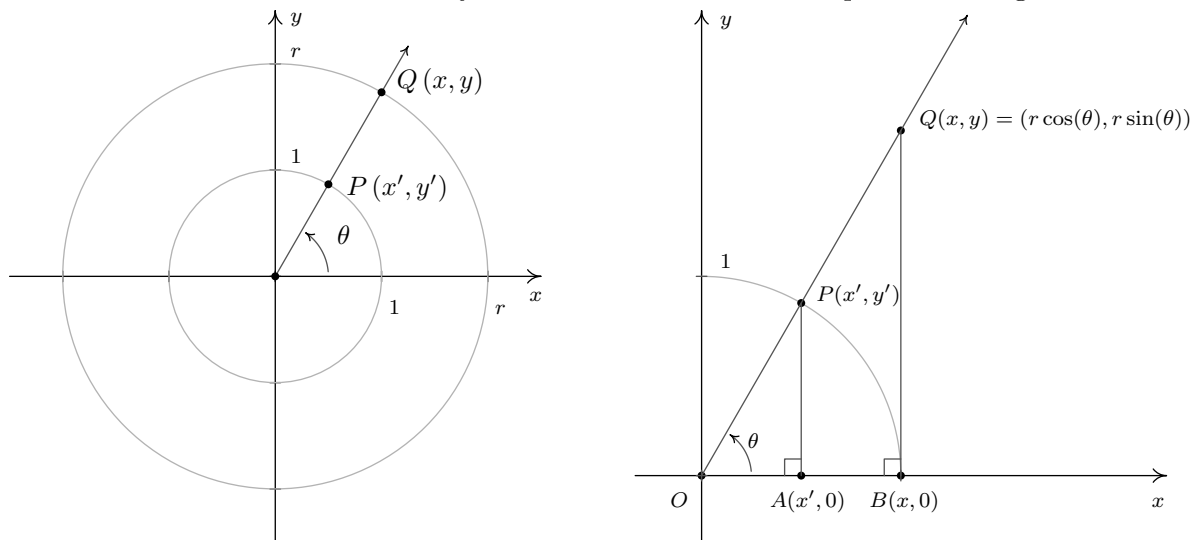

Not only can we describe the coordinates of Q in terms of $\cos(\theta)$ and $\sin(\theta)$ but since the radius of the circle is $r = \sqrt{x^2 + y^2}$, we can also express $\cos(\theta)$ and $\sin(\theta)$ in terms of the coordinates of Q . These results are summarized in the following theorem.

Theorem 8.3. If $Q(x, y)$ is the point on the terminal side of an angle θ , plotted in standard position, which lies on the circle $x^2 + y^2 = r^2$ then $x = r \cos(\theta)$ and $y = r \sin(\theta)$. Moreover,

$$\cos(\theta) = \frac{x}{r} = \frac{x}{\sqrt{x^2 + y^2}} \quad \text{and} \quad \sin(\theta) = \frac{y}{r} = \frac{y}{\sqrt{x^2 + y^2}}$$

¹⁰Do you remember why?

Note that in the case of the Unit Circle we have $r = \sqrt{x^2 + y^2} = 1$, so Theorem 8.3 reduces to our definitions of $\cos(\theta)$ and $\sin(\theta)$.

Example 8.2.6.

1. Suppose that the terminal side of an angle θ , when plotted in standard position, contains the point $Q(4, -2)$. Find $\sin(\theta)$ and $\cos(\theta)$.
2. In Example 8.1.5 in Section 8.1, we approximated the radius of the earth at 41.628° north latitude to be 2960 miles. Justify this approximation if the radius of the Earth at the Equator is approximately 3960 miles.

Solution.

1. Using Theorem 8.3 with $x = 4$ and $y = -2$, we find $r = \sqrt{(4)^2 + (-2)^2} = \sqrt{20} = 2\sqrt{5}$ so that $\cos(\theta) = \frac{x}{r} = \frac{4}{2\sqrt{5}} = \frac{2\sqrt{5}}{5}$ and $\sin(\theta) = \frac{y}{r} = \frac{-2}{2\sqrt{5}} = -\frac{\sqrt{5}}{5}$.
2. Assuming the Earth is a sphere, a cross-section through the poles produces a circle of radius 3960 miles. Viewing the Equator as the x -axis, the value we seek is the x -coordinate of the point $Q(x, y)$ indicated in the figure below.

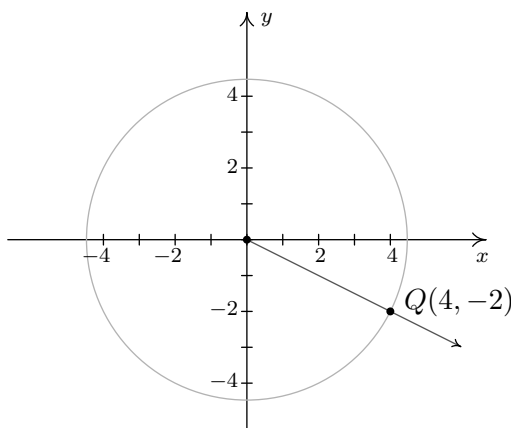

The terminal side of θ contains $Q(4, -2)$

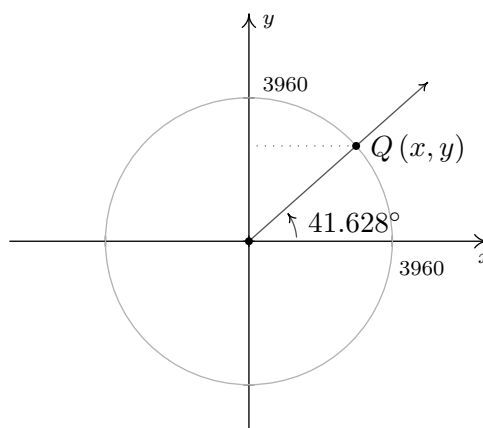

A point on the Earth at 41.628° N

Using Theorem 8.3, we get $x = 3960 \cos(41.628^\circ)$. Using a calculator in ‘degree’ mode, we find $3960 \cos(41.628^\circ) \approx 2960$. Hence, the radius of the Earth at North Latitude 41.628° is approximately 2960 miles.

```

NORMAL SCI ENG
FLOAT 0 1 2 3 4 5 6 7 8 9
RADIAN DEGREE
FUNC PAR POL SEQ
CONNECTED DOT
SEQUENTIAL SIMUL
REAL a+bi r<^>θ
FULL HORIZ G-T
SETCLOCK 10/07/01 21:55

```

```

3960cos(41.628)
2959.995241

```

□

Theorem 8.3 gives us what we need to describe the position of an object traveling in a circular path of radius r with constant angular velocity ω . Suppose that at time t , the object has swept out an angle measuring θ radians. If we assume that the object is at the point $(r, 0)$ when $t = 0$, the angle θ is in standard position. By definition, $\omega = \frac{\theta}{t}$ which we rewrite as $\theta = \omega t$. According to Theorem 8.3, the location of the object $Q(x, y)$ on the circle is found using the equations $x = r \cos(\theta) = r \cos(\omega t)$ and $y = r \sin(\theta) = r \sin(\omega t)$. Hence, at time t , the object is at the point $(r \cos(\omega t), r \sin(\omega t))$. We have just argued the following.

Equation 8.3. Suppose an object is traveling in a circular path of radius r centered at the origin with constant angular velocity ω . If $t = 0$ corresponds to the point $(r, 0)$, then the x and y coordinates of the object are functions of t and are given by $x = r \cos(\omega t)$ and $y = r \sin(\omega t)$. Here, $\omega > 0$ indicates a counter-clockwise direction and $\omega < 0$ indicates a clockwise direction.

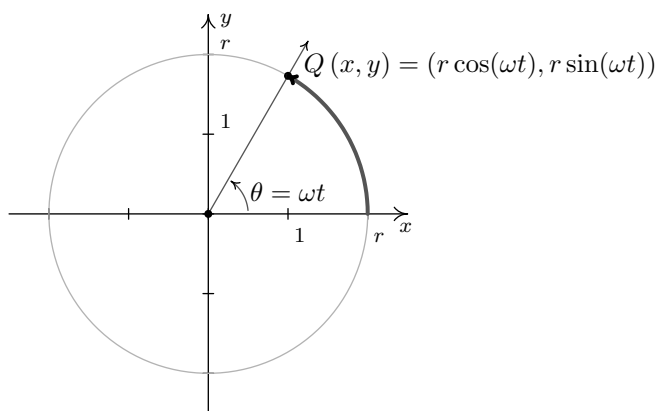

Equations for Circular Motion

Example 8.2.7. Suppose we are in the situation of Example 8.1.5. Find the equations of motion of Lakeland Community College as the earth rotates.

Solution. From Example 8.1.5, we take $r = 2960$ miles and $\omega = \frac{\pi}{12 \text{ hours}}$. Hence, the equations of motion are $x = r \cos(\omega t) = 2960 \cos\left(\frac{\pi}{12}t\right)$ and $y = r \sin(\omega t) = 2960 \sin\left(\frac{\pi}{12}t\right)$, where x and y are measured in miles and t is measured in hours. \square

In addition to circular motion, Theorem 8.3 is also the key to developing what is usually called ‘right triangle’ trigonometry.¹¹ As we shall see in the sections to come, many applications in trigonometry involve finding the measures of the angles in, and lengths of the sides of, right triangles. Indeed, we made good use of some properties of right triangles to find the exact values of the cosine and sine of many of the angles in Example 8.2.1, so the following development shouldn’t be that much of a surprise. Consider the generic right triangle below with corresponding acute angle θ . The side with length a is called the side of the triangle *adjacent* to θ ; the side with length b is called the side of the triangle *opposite* θ ; and the remaining side of length c (the side opposite the right angle) is

¹¹You may have been exposed to this in High School.

called the hypotenuse. We now imagine drawing this triangle in Quadrant I so that the angle θ is in standard position with the adjacent side to θ lying along the positive x -axis.

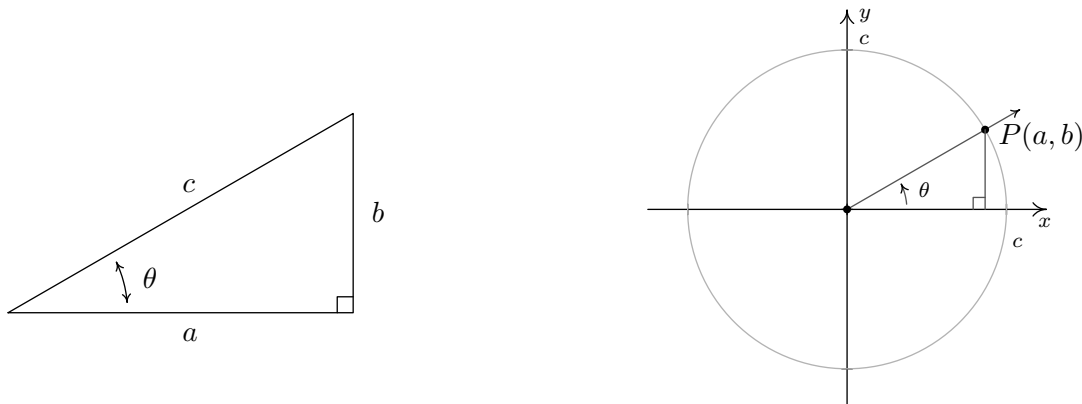

According to the Pythagorean Theorem, $a^2 + b^2 = c^2$, so that the point $P(a, b)$ lies on a circle of radius c . Theorem 8.3 tells us that $\cos(\theta) = \frac{a}{c}$ and $\sin(\theta) = \frac{b}{c}$, so we have determined the cosine and sine of θ in terms of the lengths of the sides of the right triangle. Thus we have the following theorem.

Theorem 8.4. Suppose θ is an acute angle residing in a right triangle. If the length of the side adjacent to θ is a , the length of the side opposite θ is b , and the length of the hypotenuse is c , then $\cos(\theta) = \frac{a}{c}$ and $\sin(\theta) = \frac{b}{c}$.

Example 8.2.8. Find the measure of the missing angle and the lengths of the missing sides of:

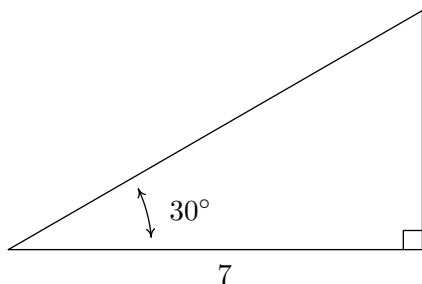

Solution. The first and easiest task is to find the measure of the missing angle. Since the sum of angles of a triangle is 180° , we know that the missing angle has measure $180^\circ - 30^\circ - 90^\circ = 60^\circ$. We now proceed to find the lengths of the remaining two sides of the triangle. Let c denote the length of the hypotenuse of the triangle. By Theorem 8.4, we have $\cos(30^\circ) = \frac{7}{c}$, or $c = \frac{7}{\cos(30^\circ)}$. Since $\cos(30^\circ) = \frac{\sqrt{3}}{2}$, we have, after the usual fraction gymnastics, $c = \frac{14\sqrt{3}}{3}$. At this point, we have two ways to proceed to find the length of the side opposite the 30° angle, which we'll denote b . We know the length of the adjacent side is 7 and the length of the hypotenuse is $\frac{14\sqrt{3}}{3}$, so we

could use the Pythagorean Theorem to find the missing side and solve $(7)^2 + b^2 = \left(\frac{14\sqrt{3}}{3}\right)^2$ for b . Alternatively, we could use Theorem 8.4, namely that $\sin(30^\circ) = \frac{b}{c}$. Choosing the latter, we find $b = c \sin(30^\circ) = \frac{14\sqrt{3}}{3} \cdot \frac{1}{2} = \frac{7\sqrt{3}}{3}$. The triangle with all of its data is recorded below.

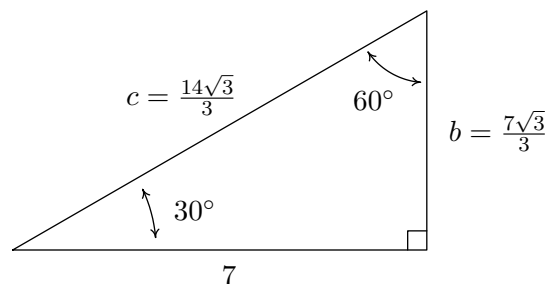

□

We close this section by noting that we can easily extend the functions cosine and sine to real numbers by identifying a real number t with the angle $\theta = t$ radians. Using this identification, we define $\cos(t) = \cos(\theta)$ and $\sin(t) = \sin(\theta)$. In practice this means expressions like $\cos(\pi)$ and $\sin(2)$ can be found by regarding the inputs as angles in radian measure or real numbers; the choice is the reader's. If we trace the identification of real numbers t with angles θ in radian measure to its roots on page 672, we can spell out this correspondence more precisely. For each real number t , we associate an oriented arc t units in length with initial point $(1, 0)$ and endpoint $P(\cos(t), \sin(t))$.

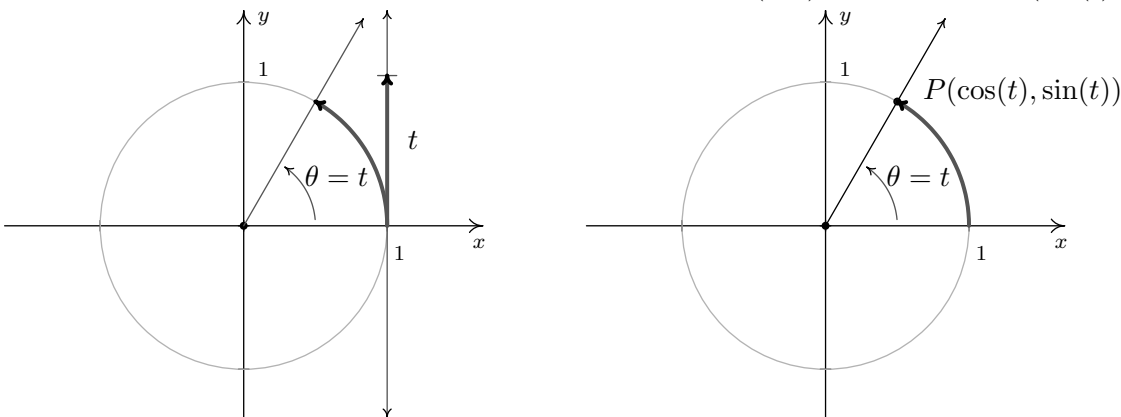

In the same way we studied polynomial, rational, exponential, and logarithmic functions, we will study the trigonometric functions $f(t) = \cos(t)$ and $g(t) = \sin(t)$. The first order of business is to find the domains and ranges of these functions. Whether we think of identifying the real number t with the angle $\theta = t$ radians, or think of wrapping an oriented arc around the Unit Circle to find coordinates on the Unit Circle, it should be clear that both the cosine and sine functions are defined for all real numbers t . In other words, the domain of $f(t) = \cos(t)$ and of $g(t) = \sin(t)$ is $(-\infty, \infty)$. Since $\cos(t)$ and $\sin(t)$ represent x - and y -coordinates, respectively, of points on the Unit Circle, they both take on all of the values between -1 and 1 , inclusive. In other words, the range of $f(t) = \cos(t)$ and of $g(t) = \sin(t)$ is the interval $[-1, 1]$. To summarize:

Theorem 8.5. Domain and Range of the Cosine and Sine Functions:

- The function $f(t) = \cos(t)$
 - has domain $(-\infty, \infty)$
 - has range $[-1, 1]$
- The function $g(t) = \sin(t)$
 - has domain $(-\infty, \infty)$
 - has range $[-1, 1]$

Suppose, as in the Exercises, we are asked to solve an equation such as $\sin(t) = -\frac{1}{2}$. As we have already mentioned, the distinction between t as a real number and as an angle $\theta = t$ radians is often blurred. Indeed, we solve $\sin(t) = -\frac{1}{2}$ in the exact same manner¹² as we did in Example 8.2.5 number 2. Our solution is only cosmetically different in that the variable used is t rather than θ : $t = \frac{7\pi}{6} + 2\pi k$ or $t = \frac{11\pi}{6} + 2\pi k$ for integers, k . We will study the cosine and sine functions in greater detail in Section 8.5. Until then, keep in mind that any properties of cosine and sine developed in the following sections which regard them as functions of *angles* in *radian* measure apply equally well if the inputs are regarded as *real numbers*.

¹²Well, to be pedantic, we would be technically using ‘reference numbers’ or ‘reference arcs’ instead of ‘reference angles’ – but the idea is the same.

8.2.2 EXERCISES

In Exercises 1 - 20, find the exact value of the cosine and sine of the given angle.

1. $\theta = 0$

2. $\theta = \frac{\pi}{4}$

3. $\theta = \frac{\pi}{3}$

4. $\theta = \frac{\pi}{2}$

5. $\theta = \frac{2\pi}{3}$

6. $\theta = \frac{3\pi}{4}$

7. $\theta = \pi$

8. $\theta = \frac{7\pi}{6}$

9. $\theta = \frac{5\pi}{4}$

10. $\theta = \frac{4\pi}{3}$

11. $\theta = \frac{3\pi}{2}$

12. $\theta = \frac{5\pi}{3}$

13. $\theta = \frac{7\pi}{4}$

14. $\theta = \frac{23\pi}{6}$

15. $\theta = -\frac{13\pi}{2}$

16. $\theta = -\frac{43\pi}{6}$

17. $\theta = -\frac{3\pi}{4}$

18. $\theta = -\frac{\pi}{6}$

19. $\theta = \frac{10\pi}{3}$

20. $\theta = 117\pi$

In Exercises 21 - 30, use the results developed throughout the section to find the requested value.

21. If $\sin(\theta) = -\frac{7}{25}$ with θ in Quadrant IV, what is $\cos(\theta)$?

22. If $\cos(\theta) = \frac{4}{9}$ with θ in Quadrant I, what is $\sin(\theta)$?

23. If $\sin(\theta) = \frac{5}{13}$ with θ in Quadrant II, what is $\cos(\theta)$?

24. If $\cos(\theta) = -\frac{2}{11}$ with θ in Quadrant III, what is $\sin(\theta)$?

25. If $\sin(\theta) = -\frac{2}{3}$ with θ in Quadrant III, what is $\cos(\theta)$?

26. If $\cos(\theta) = \frac{28}{53}$ with θ in Quadrant IV, what is $\sin(\theta)$?

27. If $\sin(\theta) = \frac{2\sqrt{5}}{5}$ and $\frac{\pi}{2} < \theta < \pi$, what is $\cos(\theta)$?

28. If $\cos(\theta) = \frac{\sqrt{10}}{10}$ and $2\pi < \theta < \frac{5\pi}{2}$, what is $\sin(\theta)$?

29. If $\sin(\theta) = -0.42$ and $\pi < \theta < \frac{3\pi}{2}$, what is $\cos(\theta)$?

30. If $\cos(\theta) = -0.98$ and $\frac{\pi}{2} < \theta < \pi$, what is $\sin(\theta)$?

In Exercises 31 - 39, find all of the angles which satisfy the given equation.

31. $\sin(\theta) = \frac{1}{2}$

32. $\cos(\theta) = -\frac{\sqrt{3}}{2}$

33. $\sin(\theta) = 0$

34. $\cos(\theta) = \frac{\sqrt{2}}{2}$

35. $\sin(\theta) = \frac{\sqrt{3}}{2}$

36. $\cos(\theta) = -1$

37. $\sin(\theta) = -1$

38. $\cos(\theta) = \frac{\sqrt{3}}{2}$

39. $\cos(\theta) = -1.001$

In Exercises 40 - 48, solve the equation for t . (See the comments following Theorem 8.5.)

40. $\cos(t) = 0$

41. $\sin(t) = -\frac{\sqrt{2}}{2}$

42. $\cos(t) = 3$

43. $\sin(t) = -\frac{1}{2}$

44. $\cos(t) = \frac{1}{2}$

45. $\sin(t) = -2$

46. $\cos(t) = 1$

47. $\sin(t) = 1$

48. $\cos(t) = -\frac{\sqrt{2}}{2}$

In Exercises 49 - 54, use your calculator to approximate the given value to three decimal places. Make sure your calculator is in the proper angle measurement mode!

49. $\sin(78.95^\circ)$

50. $\cos(-2.01)$

51. $\sin(392.994)$

52. $\cos(207^\circ)$

53. $\sin(\pi^\circ)$

54. $\cos(e)$

In Exercises 55 - 58, find the measurement of the missing angle and the lengths of the missing sides. (See Example 8.2.8)

55. Find θ , b , and c .

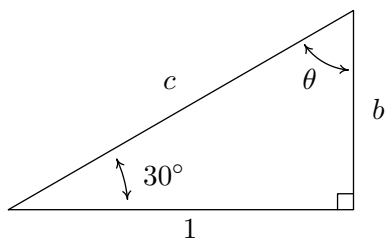

56. Find θ , a , and c .

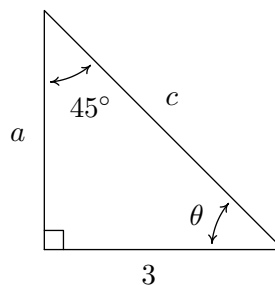

57. Find
- α
- ,
- a
- , and
- b
- .

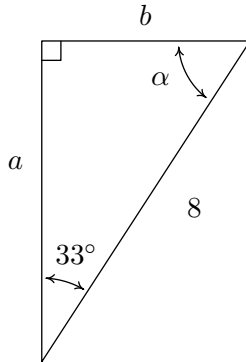

58. Find
- β
- ,
- a
- , and
- c
- .

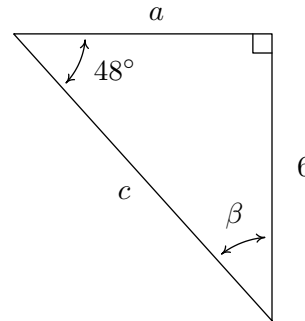

In Exercises 59 - 64, assume that θ is an acute angle in a right triangle and use Theorem 8.4 to find the requested side.

59. If $\theta = 12^\circ$ and the side adjacent to θ has length 4, how long is the hypotenuse?
 60. If $\theta = 78.123^\circ$ and the hypotenuse has length 5280, how long is the side adjacent to θ ?
 61. If $\theta = 59^\circ$ and the side opposite θ has length 117.42, how long is the hypotenuse?
 62. If $\theta = 5^\circ$ and the hypotenuse has length 10, how long is the side opposite θ ?
 63. If $\theta = 5^\circ$ and the hypotenuse has length 10, how long is the side adjacent to θ ?
 64. If $\theta = 37.5^\circ$ and the side opposite θ has length 306, how long is the side adjacent to θ ?

In Exercises 65 - 68, let θ be the angle in standard position whose terminal side contains the given point then compute $\cos(\theta)$ and $\sin(\theta)$.

65. $P(-7, 24)$ 66. $Q(3, 4)$ 67. $R(5, -9)$ 68. $T(-2, -11)$

In Exercises 69 - 72, find the equations of motion for the given scenario. Assume that the center of the motion is the origin, the motion is counter-clockwise and that $t = 0$ corresponds to a position along the positive x -axis. (See Equation 8.3 and Example 8.1.5.)

69. A point on the edge of the spinning yo-yo in Exercise 50 from Section 8.1.
 Recall: The diameter of the yo-yo is 2.25 inches and it spins at 4500 revolutions per minute.
 70. The yo-yo in exercise 52 from Section 8.1.
 Recall: The radius of the circle is 28 inches and it completes one revolution in 3 seconds.
 71. A point on the edge of the hard drive in Exercise 53 from Section 8.1.
 Recall: The diameter of the hard disk is 2.5 inches and it spins at 7200 revolutions per minute.

72. A passenger on the Big Wheel in Exercise 55 from Section 8.1.

Recall: The diameter is 128 feet and completes 2 revolutions in 2 minutes, 7 seconds.

73. Consider the numbers: 0, 1, 2, 3, 4. Take the square root of each of these numbers, then divide each by 2. The resulting numbers should look hauntingly familiar. (See the values in the table on 690.)
74. Let α and β be the two acute angles of a right triangle. (Thus α and β are complementary angles.) Show that $\sin(\alpha) = \cos(\beta)$ and $\sin(\beta) = \cos(\alpha)$. The fact that co-functions of complementary angles are equal in this case is not an accident and a more general result will be given in Section 8.4.
75. In the scenario of Equation 8.3, we assumed that at $t = 0$, the object was at the point $(r, 0)$. If this is not the case, we can adjust the equations of motion by introducing a ‘time delay.’ If $t_0 > 0$ is the first time the object passes through the point $(r, 0)$, show, with the help of your classmates, the equations of motion are $x = r \cos(\omega(t - t_0))$ and $y = r \sin(\omega(t - t_0))$.

8.2.3 ANSWERS

1. $\cos(0) = 1, \sin(0) = 0$
2. $\cos\left(\frac{\pi}{4}\right) = \frac{\sqrt{2}}{2}, \sin\left(\frac{\pi}{4}\right) = \frac{\sqrt{2}}{2}$
3. $\cos\left(\frac{\pi}{3}\right) = \frac{1}{2}, \sin\left(\frac{\pi}{3}\right) = \frac{\sqrt{3}}{2}$
4. $\cos\left(\frac{\pi}{2}\right) = 0, \sin\left(\frac{\pi}{2}\right) = 1$
5. $\cos\left(\frac{2\pi}{3}\right) = -\frac{1}{2}, \sin\left(\frac{2\pi}{3}\right) = \frac{\sqrt{3}}{2}$
6. $\cos\left(\frac{3\pi}{4}\right) = -\frac{\sqrt{2}}{2}, \sin\left(\frac{3\pi}{4}\right) = \frac{\sqrt{2}}{2}$
7. $\cos(\pi) = -1, \sin(\pi) = 0$
8. $\cos\left(\frac{7\pi}{6}\right) = -\frac{\sqrt{3}}{2}, \sin\left(\frac{7\pi}{6}\right) = -\frac{1}{2}$
9. $\cos\left(\frac{5\pi}{4}\right) = -\frac{\sqrt{2}}{2}, \sin\left(\frac{5\pi}{4}\right) = -\frac{\sqrt{2}}{2}$
10. $\cos\left(\frac{4\pi}{3}\right) = -\frac{1}{2}, \sin\left(\frac{4\pi}{3}\right) = -\frac{\sqrt{3}}{2}$
11. $\cos\left(\frac{3\pi}{2}\right) = 0, \sin\left(\frac{3\pi}{2}\right) = -1$
12. $\cos\left(\frac{5\pi}{3}\right) = \frac{1}{2}, \sin\left(\frac{5\pi}{3}\right) = -\frac{\sqrt{3}}{2}$
13. $\cos\left(\frac{7\pi}{4}\right) = \frac{\sqrt{2}}{2}, \sin\left(\frac{7\pi}{4}\right) = -\frac{\sqrt{2}}{2}$
14. $\cos\left(\frac{23\pi}{6}\right) = \frac{\sqrt{3}}{2}, \sin\left(\frac{23\pi}{6}\right) = -\frac{1}{2}$
15. $\cos\left(-\frac{13\pi}{2}\right) = 0, \sin\left(-\frac{13\pi}{2}\right) = -1$
16. $\cos\left(-\frac{43\pi}{6}\right) = -\frac{\sqrt{3}}{2}, \sin\left(-\frac{43\pi}{6}\right) = \frac{1}{2}$
17. $\cos\left(-\frac{3\pi}{4}\right) = -\frac{\sqrt{2}}{2}, \sin\left(-\frac{3\pi}{4}\right) = -\frac{\sqrt{2}}{2}$
18. $\cos\left(-\frac{\pi}{6}\right) = \frac{\sqrt{3}}{2}, \sin\left(-\frac{\pi}{6}\right) = -\frac{1}{2}$
19. $\cos\left(\frac{10\pi}{3}\right) = -\frac{1}{2}, \sin\left(\frac{10\pi}{3}\right) = -\frac{\sqrt{3}}{2}$
20. $\cos(117\pi) = -1, \sin(117\pi) = 0$
21. If $\sin(\theta) = -\frac{7}{25}$ with θ in Quadrant IV, then $\cos(\theta) = \frac{24}{25}$.
22. If $\cos(\theta) = \frac{4}{9}$ with θ in Quadrant I, then $\sin(\theta) = \frac{\sqrt{65}}{9}$.
23. If $\sin(\theta) = \frac{5}{13}$ with θ in Quadrant II, then $\cos(\theta) = -\frac{12}{13}$.
24. If $\cos(\theta) = -\frac{2}{11}$ with θ in Quadrant III, then $\sin(\theta) = -\frac{\sqrt{117}}{11}$.
25. If $\sin(\theta) = -\frac{2}{3}$ with θ in Quadrant III, then $\cos(\theta) = -\frac{\sqrt{5}}{3}$.
26. If $\cos(\theta) = \frac{28}{53}$ with θ in Quadrant IV, then $\sin(\theta) = -\frac{45}{53}$.

27. If $\sin(\theta) = \frac{2\sqrt{5}}{5}$ and $\frac{\pi}{2} < \theta < \pi$, then $\cos(\theta) = -\frac{\sqrt{5}}{5}$.
28. If $\cos(\theta) = \frac{\sqrt{10}}{10}$ and $2\pi < \theta < \frac{5\pi}{2}$, then $\sin(\theta) = \frac{3\sqrt{10}}{10}$.
29. If $\sin(\theta) = -0.42$ and $\pi < \theta < \frac{3\pi}{2}$, then $\cos(\theta) = -\sqrt{0.8236} \approx -0.9075$.
30. If $\cos(\theta) = -0.98$ and $\frac{\pi}{2} < \theta < \pi$, then $\sin(\theta) = \sqrt{0.0396} \approx 0.1990$.
31. $\sin(\theta) = \frac{1}{2}$ when $\theta = \frac{\pi}{6} + 2\pi k$ or $\theta = \frac{5\pi}{6} + 2\pi k$ for any integer k .
32. $\cos(\theta) = -\frac{\sqrt{3}}{2}$ when $\theta = \frac{5\pi}{6} + 2\pi k$ or $\theta = \frac{7\pi}{6} + 2\pi k$ for any integer k .
33. $\sin(\theta) = 0$ when $\theta = \pi k$ for any integer k .
34. $\cos(\theta) = \frac{\sqrt{2}}{2}$ when $\theta = \frac{\pi}{4} + 2\pi k$ or $\theta = \frac{7\pi}{4} + 2\pi k$ for any integer k .
35. $\sin(\theta) = \frac{\sqrt{3}}{2}$ when $\theta = \frac{\pi}{3} + 2\pi k$ or $\theta = \frac{2\pi}{3} + 2\pi k$ for any integer k .
36. $\cos(\theta) = -1$ when $\theta = (2k + 1)\pi$ for any integer k .
37. $\sin(\theta) = -1$ when $\theta = \frac{3\pi}{2} + 2\pi k$ for any integer k .
38. $\cos(\theta) = \frac{\sqrt{3}}{2}$ when $\theta = \frac{\pi}{6} + 2\pi k$ or $\theta = \frac{11\pi}{6} + 2\pi k$ for any integer k .
39. $\cos(\theta) = -1.001$ never happens
40. $\cos(t) = 0$ when $t = \frac{\pi}{2} + \pi k$ for any integer k .
41. $\sin(t) = -\frac{\sqrt{2}}{2}$ when $t = \frac{5\pi}{4} + 2\pi k$ or $t = \frac{7\pi}{4} + 2\pi k$ for any integer k .
42. $\cos(t) = 3$ never happens.
43. $\sin(t) = -\frac{1}{2}$ when $t = \frac{7\pi}{6} + 2\pi k$ or $t = \frac{11\pi}{6} + 2\pi k$ for any integer k .
44. $\cos(t) = \frac{1}{2}$ when $t = \frac{\pi}{3} + 2\pi k$ or $t = \frac{5\pi}{3} + 2\pi k$ for any integer k .
45. $\sin(t) = -2$ never happens
46. $\cos(t) = 1$ when $t = 2\pi k$ for any integer k .

47. $\sin(t) = 1$ when $t = \frac{\pi}{2} + 2\pi k$ for any integer k .
48. $\cos(t) = -\frac{\sqrt{2}}{2}$ when $t = \frac{3\pi}{4} + 2\pi k$ or $t = \frac{5\pi}{4} + 2\pi k$ for any integer k .
49. $\sin(78.95^\circ) \approx 0.981$ 50. $\cos(-2.01) \approx -0.425$ 51. $\sin(392.994) \approx -0.291$
52. $\cos(207^\circ) \approx -0.891$ 53. $\sin(\pi^\circ) \approx 0.055$ 54. $\cos(e) \approx -0.912$
55. $\theta = 60^\circ, b = \frac{\sqrt{3}}{3}, c = \frac{2\sqrt{3}}{3}$
56. $\theta = 45^\circ, a = 3, c = 3\sqrt{2}$
57. $\alpha = 57^\circ, a = 8 \cos(33^\circ) \approx 6.709, b = 8 \sin(33^\circ) \approx 4.357$
58. $\beta = 42^\circ, c = \frac{6}{\sin(48^\circ)} \approx 8.074, a = \sqrt{c^2 - 6^2} \approx 5.402$
59. The hypotenuse has length $\frac{4}{\cos(12^\circ)} \approx 4.089$.
60. The side adjacent to θ has length $5280 \cos(78.123^\circ) \approx 1086.68$.
61. The hypotenuse has length $\frac{117.42}{\sin(59^\circ)} \approx 136.99$.
62. The side opposite θ has length $10 \sin(5^\circ) \approx 0.872$.
63. The side adjacent to θ has length $10 \cos(5^\circ) \approx 9.962$.
64. The hypotenuse has length $c = \frac{306}{\sin(37.5^\circ)} \approx 502.660$, so the side adjacent to θ has length $\sqrt{c^2 - 306^2} \approx 398.797$.
65. $\cos(\theta) = -\frac{7}{25}, \sin(\theta) = \frac{24}{25}$
66. $\cos(\theta) = \frac{3}{5}, \sin(\theta) = \frac{4}{5}$
67. $\cos(\theta) = \frac{5\sqrt{106}}{106}, \sin(\theta) = -\frac{9\sqrt{106}}{106}$
68. $\cos(\theta) = -\frac{2\sqrt{5}}{25}, \sin(\theta) = -\frac{11\sqrt{5}}{25}$
69. $r = 1.125$ inches, $\omega = 9000\pi \frac{\text{radians}}{\text{minute}}, x = 1.125 \cos(9000\pi t), y = 1.125 \sin(9000\pi t)$. Here x and y are measured in inches and t is measured in minutes.

70. $r = 28$ inches, $\omega = \frac{2\pi}{3} \frac{\text{radians}}{\text{second}}$, $x = 28 \cos\left(\frac{2\pi}{3} t\right)$, $y = 28 \sin\left(\frac{2\pi}{3} t\right)$. Here x and y are measured in inches and t is measured in seconds.
71. $r = 1.25$ inches, $\omega = 14400\pi \frac{\text{radians}}{\text{minute}}$, $x = 1.25 \cos(14400\pi t)$, $y = 1.25 \sin(14400\pi t)$. Here x and y are measured in inches and t is measured in minutes.
72. $r = 64$ feet, $\omega = \frac{4\pi}{127} \frac{\text{radians}}{\text{second}}$, $x = 64 \cos\left(\frac{4\pi}{127} t\right)$, $y = 64 \sin\left(\frac{4\pi}{127} t\right)$. Here x and y are measured in feet and t is measured in seconds

8.3 THE SIX CIRCULAR FUNCTIONS AND FUNDAMENTAL IDENTITIES

In section 8.2, we defined $\cos(\theta)$ and $\sin(\theta)$ for angles θ using the coordinate values of points on the Unit Circle. As such, these functions earn the moniker **circular functions**.¹ It turns out that cosine and sine are just two of the six commonly used circular functions which we define below.

Definition 8.2. The Circular Functions: Suppose θ is an angle plotted in standard position and $P(x, y)$ is the point on the terminal side of θ which lies on the Unit Circle.

- The **cosine** of θ , denoted $\cos(\theta)$, is defined by $\cos(\theta) = x$.
- The **sine** of θ , denoted $\sin(\theta)$, is defined by $\sin(\theta) = y$.
- The **secant** of θ , denoted $\sec(\theta)$, is defined by $\sec(\theta) = \frac{1}{x}$, provided $x \neq 0$.
- The **cosecant** of θ , denoted $\csc(\theta)$, is defined by $\csc(\theta) = \frac{1}{y}$, provided $y \neq 0$.
- The **tangent** of θ , denoted $\tan(\theta)$, is defined by $\tan(\theta) = \frac{y}{x}$, provided $x \neq 0$.
- The **cotangent** of θ , denoted $\cot(\theta)$, is defined by $\cot(\theta) = \frac{x}{y}$, provided $y \neq 0$.

While we left the history of the name ‘sine’ as an interesting research project in Section 8.2, the names ‘tangent’ and ‘secant’ can be explained using the diagram below. Consider the acute angle θ below in standard position. Let $P(x, y)$ denote, as usual, the point on the terminal side of θ which lies on the Unit Circle and let $Q(1, y')$ denote the point on the terminal side of θ which lies on the vertical line $x = 1$.

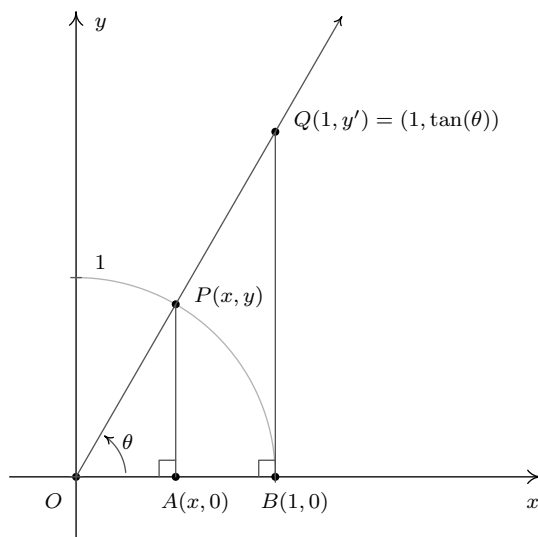

¹In Theorem 8.4 we also showed cosine and sine to be functions of an angle residing in a right triangle so we could just as easily call them *trigonometric* functions. In later sections, you will find that we do indeed use the phrase ‘trigonometric function’ interchangeably with the term ‘circular function’.

The word ‘tangent’ comes from the Latin meaning ‘to touch,’ and for this reason, the line $x = 1$ is called a *tangent* line to the Unit Circle since it intersects, or ‘touches’, the circle at only one point, namely $(1, 0)$. Dropping perpendiculars from P and Q creates a pair of similar triangles $\triangle OPA$ and $\triangle OQB$. Thus $\frac{y'}{y} = \frac{1}{x}$ which gives $y' = \frac{y}{x} = \tan(\theta)$, where this last equality comes from applying Definition 8.2. We have just shown that for acute angles θ , $\tan(\theta)$ is the y -coordinate of the point on the terminal side of θ which lies on the line $x = 1$ which is *tangent* to the Unit Circle. Now the word ‘secant’ means ‘to cut’, so a secant line is any line that ‘cuts through’ a circle at two points.² The line containing the terminal side of θ is a secant line since it intersects the Unit Circle in Quadrants I and III. With the point P lying on the Unit Circle, the length of the hypotenuse of $\triangle OPA$ is 1. If we let h denote the length of the hypotenuse of $\triangle OQB$, we have from similar triangles that $\frac{h}{1} = \frac{1}{x}$, or $h = \frac{1}{x} = \sec(\theta)$. Hence for an acute angle θ , $\sec(\theta)$ is the length of the line segment which lies on the secant line determined by the terminal side of θ and ‘cuts off’ the tangent line $x = 1$. Not only do these observations help explain the names of these functions, they serve as the basis for a fundamental inequality needed for Calculus which we’ll explore in the Exercises.

Of the six circular functions, only cosine and sine are defined for all angles. Since $\cos(\theta) = x$ and $\sin(\theta) = y$ in Definition 8.2, it is customary to rephrase the remaining four circular functions in terms of cosine and sine. The following theorem is a result of simply replacing x with $\cos(\theta)$ and y with $\sin(\theta)$ in Definition 8.2.

Theorem 8.6. Reciprocal and Quotient Identities:

- $\sec(\theta) = \frac{1}{\cos(\theta)}$, provided $\cos(\theta) \neq 0$; if $\cos(\theta) = 0$, $\sec(\theta)$ is undefined.
- $\csc(\theta) = \frac{1}{\sin(\theta)}$, provided $\sin(\theta) \neq 0$; if $\sin(\theta) = 0$, $\csc(\theta)$ is undefined.
- $\tan(\theta) = \frac{\sin(\theta)}{\cos(\theta)}$, provided $\cos(\theta) \neq 0$; if $\cos(\theta) = 0$, $\tan(\theta)$ is undefined.
- $\cot(\theta) = \frac{\cos(\theta)}{\sin(\theta)}$, provided $\sin(\theta) \neq 0$; if $\sin(\theta) = 0$, $\cot(\theta)$ is undefined.

It is high time for an example.

Example 8.3.1. Find the indicated value, if it exists.

1. $\sec(60^\circ)$
2. $\csc\left(\frac{7\pi}{4}\right)$
3. $\cot(3)$
4. $\tan(\theta)$, where θ is any angle coterminal with $\frac{3\pi}{2}$.
5. $\cos(\theta)$, where $\csc(\theta) = -\sqrt{5}$ and θ is a Quadrant IV angle.
6. $\sin(\theta)$, where $\tan(\theta) = 3$ and $\pi < \theta < \frac{3\pi}{2}$.

²Compare this with the definition given in Section 2.1.

Solution.

1. According to Theorem 8.6, $\sec(60^\circ) = \frac{1}{\cos(60^\circ)}$. Hence, $\sec(60^\circ) = \frac{1}{(1/2)} = 2$.
2. Since $\sin\left(\frac{7\pi}{4}\right) = -\frac{\sqrt{2}}{2}$, $\csc\left(\frac{7\pi}{4}\right) = \frac{1}{\sin\left(\frac{7\pi}{4}\right)} = \frac{1}{-\sqrt{2}/2} = -\frac{2}{\sqrt{2}} = -\sqrt{2}$.
3. Since $\theta = 3$ radians is not one of the ‘common angles’ from Section 8.2, we resort to the calculator for a decimal approximation. Ensuring that the calculator is in radian mode, we find $\cot(3) = \frac{\cos(3)}{\sin(3)} \approx -7.015$.

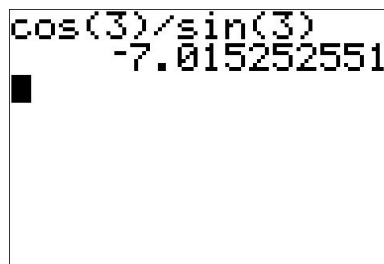
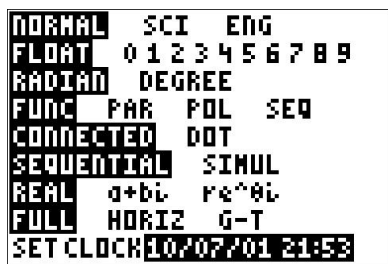

4. If θ is coterminal with $\frac{3\pi}{2}$, then $\cos(\theta) = \cos\left(\frac{3\pi}{2}\right) = 0$ and $\sin(\theta) = \sin\left(\frac{3\pi}{2}\right) = -1$. Attempting to compute $\tan(\theta) = \frac{\sin(\theta)}{\cos(\theta)}$ results in $\frac{-1}{0}$, so $\tan(\theta)$ is undefined.
5. We are given that $\csc(\theta) = \frac{1}{\sin(\theta)} = -\sqrt{5}$ so $\sin(\theta) = -\frac{1}{\sqrt{5}} = -\frac{\sqrt{5}}{5}$. As we saw in Section 8.2, we can use the Pythagorean Identity, $\cos^2(\theta) + \sin^2(\theta) = 1$, to find $\cos(\theta)$ by knowing $\sin(\theta)$. Substituting, we get $\cos^2(\theta) + \left(-\frac{\sqrt{5}}{5}\right)^2 = 1$, which gives $\cos^2(\theta) = \frac{4}{5}$, or $\cos(\theta) = \pm\frac{2\sqrt{5}}{5}$. Since θ is a Quadrant IV angle, $\cos(\theta) > 0$, so $\cos(\theta) = \frac{2\sqrt{5}}{5}$.
6. If $\tan(\theta) = 3$, then $\frac{\sin(\theta)}{\cos(\theta)} = 3$. Be careful - this does **NOT** mean we can take $\sin(\theta) = 3$ and $\cos(\theta) = 1$. Instead, from $\frac{\sin(\theta)}{\cos(\theta)} = 3$ we get: $\sin(\theta) = 3\cos(\theta)$. To relate $\cos(\theta)$ and $\sin(\theta)$, we once again employ the Pythagorean Identity, $\cos^2(\theta) + \sin^2(\theta) = 1$. Solving $\sin(\theta) = 3\cos(\theta)$ for $\cos(\theta)$, we find $\cos(\theta) = \frac{1}{3}\sin(\theta)$. Substituting this into the Pythagorean Identity, we find $\sin^2(\theta) + \left(\frac{1}{3}\sin(\theta)\right)^2 = 1$. Solving, we get $\sin^2(\theta) = \frac{9}{10}$ so $\sin(\theta) = \pm\frac{3\sqrt{10}}{10}$. Since $\pi < \theta < \frac{3\pi}{2}$, θ is a Quadrant III angle. This means $\sin(\theta) < 0$, so our final answer is $\sin(\theta) = -\frac{3\sqrt{10}}{10}$. \square

While the Reciprocal and Quotient Identities presented in Theorem 8.6 allow us to always reduce problems involving secant, cosecant, tangent and cotangent to problems involving cosine and sine, it is not always convenient to do so.³ It is worth taking the time to memorize the tangent and cotangent values of the common angles summarized below.

³As we shall see shortly, when solving equations involving secant and cosecant, we usually convert back to cosines and sines. However, when solving for tangent or cotangent, we usually stick with what we're dealt.

Tangent and Cotangent Values of Common Angles

$\theta(\text{degrees})$	$\theta(\text{radians})$	$\tan(\theta)$	$\cot(\theta)$
0°	0	0	undefined
30°	$\frac{\pi}{6}$	$\frac{\sqrt{3}}{3}$	$\sqrt{3}$
45°	$\frac{\pi}{4}$	1	1
60°	$\frac{\pi}{3}$	$\sqrt{3}$	$\frac{\sqrt{3}}{3}$
90°	$\frac{\pi}{2}$	undefined	0

Coupling Theorem 8.6 with the Reference Angle Theorem, Theorem 8.2, we get the following.

Theorem 8.7. Generalized Reference Angle Theorem. The values of the circular functions of an angle, if they exist, are the same, up to a sign, of the corresponding circular functions of its reference angle. More specifically, if α is the reference angle for θ , then: $\cos(\theta) = \pm \cos(\alpha)$, $\sin(\theta) = \pm \sin(\alpha)$, $\sec(\theta) = \pm \sec(\alpha)$, $\csc(\theta) = \pm \csc(\alpha)$, $\tan(\theta) = \pm \tan(\alpha)$ and $\cot(\theta) = \pm \cot(\alpha)$. The choice of the (\pm) depends on the quadrant in which the terminal side of θ lies.

We put Theorem 8.7 to good use in the following example.

Example 8.3.2. Find all angles which satisfy the given equation.

1. $\sec(\theta) = 2$

2. $\tan(\theta) = \sqrt{3}$

3. $\cot(\theta) = -1$.

Solution.

- To solve $\sec(\theta) = 2$, we convert to cosines and get $\frac{1}{\cos(\theta)} = 2$ or $\cos(\theta) = \frac{1}{2}$. This is the exact same equation we solved in Example 8.2.5, number 1, so we know the answer is: $\theta = \frac{\pi}{3} + 2\pi k$ or $\theta = \frac{5\pi}{3} + 2\pi k$ for integers k .
- From the table of common values, we see $\tan\left(\frac{\pi}{3}\right) = \sqrt{3}$. According to Theorem 8.7, we know the solutions to $\tan(\theta) = \sqrt{3}$ must, therefore, have a reference angle of $\frac{\pi}{3}$. Our next task is to determine in which quadrants the solutions to this equation lie. Since tangent is defined as the ratio $\frac{y}{x}$ of points (x, y) on the Unit Circle with $x \neq 0$, tangent is positive when x and y have the same sign (i.e., when they are both positive or both negative.) This happens in Quadrants I and III. In Quadrant I, we get the solutions: $\theta = \frac{\pi}{3} + 2\pi k$ for integers k , and for Quadrant III, we get $\theta = \frac{4\pi}{3} + 2\pi k$ for integers k . While these descriptions of the solutions are correct, they can be combined into one list as $\theta = \frac{\pi}{3} + \pi k$ for integers k . The latter form of the solution is best understood looking at the geometry of the situation in the diagram below.⁴

⁴See Example 8.2.5 number 3 in Section 8.2 for another example of this kind of simplification of the solution.

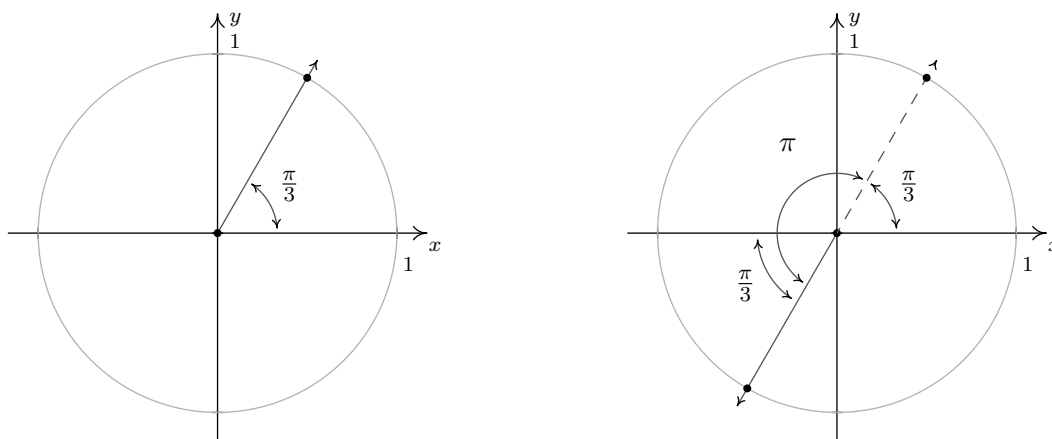

3. From the table of common values, we see that $\frac{\pi}{4}$ has a cotangent of 1, which means the solutions to $\cot(\theta) = -1$ have a reference angle of $\frac{\pi}{4}$. To find the quadrants in which our solutions lie, we note that $\cot(\theta) = \frac{x}{y}$ for a point (x, y) on the Unit Circle where $y \neq 0$. If $\cot(\theta)$ is negative, then x and y must have different signs (i.e., one positive and one negative.) Hence, our solutions lie in Quadrants II and IV. Our Quadrant II solution is $\theta = \frac{3\pi}{4} + 2\pi k$, and for Quadrant IV, we get $\theta = \frac{7\pi}{4} + 2\pi k$ for integers k . Can these lists be combined? Indeed they can - one such way to capture all the solutions is: $\theta = \frac{3\pi}{4} + \pi k$ for integers k .

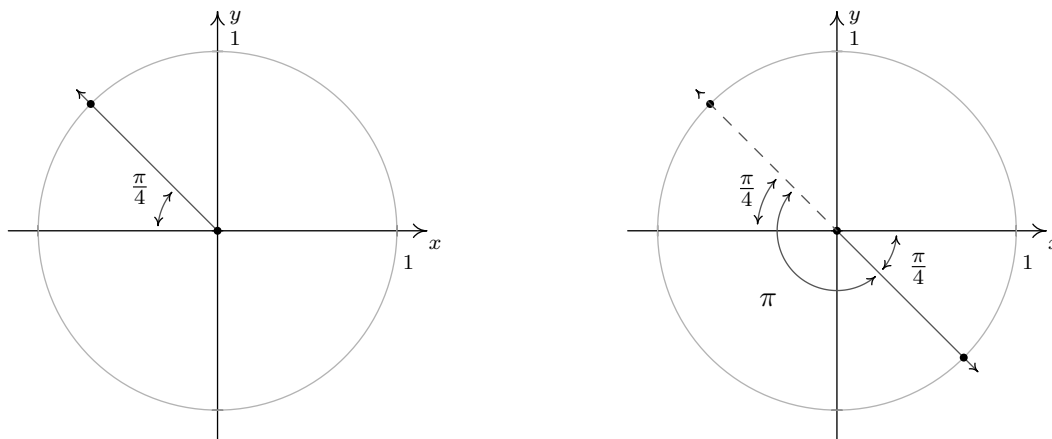

□

We have already seen the importance of identities in trigonometry. Our next task is to use the Reciprocal and Quotient Identities found in Theorem 8.6 coupled with the Pythagorean Identity found in Theorem 8.1 to derive new Pythagorean-like identities for the remaining four circular functions. Assuming $\cos(\theta) \neq 0$, we may start with $\cos^2(\theta) + \sin^2(\theta) = 1$ and divide both sides by $\cos^2(\theta)$ to obtain $1 + \frac{\sin^2(\theta)}{\cos^2(\theta)} = \frac{1}{\cos^2(\theta)}$. Using properties of exponents along with the Reciprocal and Quotient Identities, this reduces to $1 + \tan^2(\theta) = \sec^2(\theta)$. If $\sin(\theta) \neq 0$, we can divide both sides of the identity $\cos^2(\theta) + \sin^2(\theta) = 1$ by $\sin^2(\theta)$, apply Theorem 8.6 once again, and obtain $\cot^2(\theta) + 1 = \csc^2(\theta)$. These three Pythagorean Identities are worth memorizing and they, along with some of their other common forms, are summarized in the following theorem.

Theorem 8.8. The Pythagorean Identities:

1. $\cos^2(\theta) + \sin^2(\theta) = 1.$

Common Alternate Forms:

- $1 - \sin^2(\theta) = \cos^2(\theta)$
- $1 - \cos^2(\theta) = \sin^2(\theta)$

2. $1 + \tan^2(\theta) = \sec^2(\theta)$, provided $\cos(\theta) \neq 0.$

Common Alternate Forms:

- $\sec^2(\theta) - \tan^2(\theta) = 1$
- $\sec^2(\theta) - 1 = \tan^2(\theta)$

3. $1 + \cot^2(\theta) = \csc^2(\theta)$, provided $\sin(\theta) \neq 0.$

Common Alternate Forms:

- $\csc^2(\theta) - \cot^2(\theta) = 1$
- $\csc^2(\theta) - 1 = \cot^2(\theta)$

Trigonometric identities play an important role in not just Trigonometry, but in Calculus as well. We'll use them in this book to find the values of the circular functions of an angle and solve equations and inequalities. In Calculus, they are needed to simplify otherwise complicated expressions. In the next example, we make good use of the Theorems 8.6 and 8.8.

Example 8.3.3. Verify the following identities. Assume that all quantities are defined.

1. $\frac{1}{\csc(\theta)} = \sin(\theta)$

2. $\tan(\theta) = \sin(\theta) \sec(\theta)$

3. $(\sec(\theta) - \tan(\theta))(\sec(\theta) + \tan(\theta)) = 1$

4. $\frac{\sec(\theta)}{1 - \tan(\theta)} = \frac{1}{\cos(\theta) - \sin(\theta)}$

5. $6 \sec(\theta) \tan(\theta) = \frac{3}{1 - \sin(\theta)} - \frac{3}{1 + \sin(\theta)}$

6. $\frac{\sin(\theta)}{1 - \cos(\theta)} = \frac{1 + \cos(\theta)}{\sin(\theta)}$

Solution. In verifying identities, we typically start with the more complicated side of the equation and use known identities to *transform* it into the other side of the equation.

1. To verify $\frac{1}{\csc(\theta)} = \sin(\theta)$, we start with the left side. Using $\csc(\theta) = \frac{1}{\sin(\theta)}$, we get:

$$\frac{1}{\csc(\theta)} = \frac{1}{\frac{1}{\sin(\theta)}} = \sin(\theta),$$

which is what we were trying to prove.

2. Starting with the right hand side of $\tan(\theta) = \sin(\theta) \sec(\theta)$, we use $\sec(\theta) = \frac{1}{\cos(\theta)}$ and find:

$$\sin(\theta) \sec(\theta) = \sin(\theta) \frac{1}{\cos(\theta)} = \frac{\sin(\theta)}{\cos(\theta)} = \tan(\theta),$$

where the last equality is courtesy of Theorem 8.6.

3. Expanding the left hand side of the equation gives: $(\sec(\theta) - \tan(\theta))(\sec(\theta) + \tan(\theta)) = \sec^2(\theta) - \tan^2(\theta)$. According to Theorem 8.8, $\sec^2(\theta) - \tan^2(\theta) = 1$. Putting it all together,

$$(\sec(\theta) - \tan(\theta))(\sec(\theta) + \tan(\theta)) = \sec^2(\theta) - \tan^2(\theta) = 1.$$

4. While both sides of our last identity contain fractions, the left side affords us more opportunities to use our identities.⁵ Substituting $\sec(\theta) = \frac{1}{\cos(\theta)}$ and $\tan(\theta) = \frac{\sin(\theta)}{\cos(\theta)}$, we get:

$$\begin{aligned} \frac{\sec(\theta)}{1 - \tan(\theta)} &= \frac{\frac{1}{\cos(\theta)}}{1 - \frac{\sin(\theta)}{\cos(\theta)}} = \frac{\frac{1}{\cos(\theta)}}{1 - \frac{\sin(\theta)}{\cos(\theta)}} \cdot \frac{\cos(\theta)}{\cos(\theta)} \\ &= \frac{\left(\frac{1}{\cos(\theta)}\right)(\cos(\theta))}{\left(1 - \frac{\sin(\theta)}{\cos(\theta)}\right)(\cos(\theta))} = \frac{1}{(1)(\cos(\theta)) - \left(\frac{\sin(\theta)}{\cos(\theta)}\right)(\cos(\theta))} \\ &= \frac{1}{\cos(\theta) - \sin(\theta)}, \end{aligned}$$

which is exactly what we had set out to show.

5. The right hand side of the equation seems to hold more promise. We get common denominators and add:

$$\begin{aligned} \frac{3}{1 - \sin(\theta)} - \frac{3}{1 + \sin(\theta)} &= \frac{3(1 + \sin(\theta))}{(1 - \sin(\theta))(1 + \sin(\theta))} - \frac{3(1 - \sin(\theta))}{(1 + \sin(\theta))(1 - \sin(\theta))} \\ &= \frac{3 + 3\sin(\theta)}{1 - \sin^2(\theta)} - \frac{3 - 3\sin(\theta)}{1 - \sin^2(\theta)} \\ &= \frac{(3 + 3\sin(\theta)) - (3 - 3\sin(\theta))}{1 - \sin^2(\theta)} \\ &= \frac{6\sin(\theta)}{1 - \sin^2(\theta)} \end{aligned}$$

⁵Or, to put to another way, earn more partial credit if this were an exam question!

At this point, it is worth pausing to remind ourselves of our goal. We wish to transform this expression into $6 \sec(\theta) \tan(\theta)$. Using a reciprocal and quotient identity, we find $6 \sec(\theta) \tan(\theta) = 6 \left(\frac{1}{\cos(\theta)} \right) \left(\frac{\sin(\theta)}{\cos(\theta)} \right)$. In other words, we need to get cosines in our denominator. Theorem 8.8 tells us $1 - \sin^2(\theta) = \cos^2(\theta)$ so we get:

$$\begin{aligned} \frac{3}{1 - \sin(\theta)} - \frac{3}{1 + \sin(\theta)} &= \frac{6 \sin(\theta)}{1 - \sin^2(\theta)} = \frac{6 \sin(\theta)}{\cos^2(\theta)} \\ &= 6 \left(\frac{1}{\cos(\theta)} \right) \left(\frac{\sin(\theta)}{\cos(\theta)} \right) = 6 \sec(\theta) \tan(\theta) \end{aligned}$$

6. It is debatable which side of the identity is more complicated. One thing which stands out is that the denominator on the left hand side is $1 - \cos(\theta)$, while the numerator of the right hand side is $1 + \cos(\theta)$. This suggests the strategy of starting with the left hand side and multiplying the numerator and denominator by the quantity $1 + \cos(\theta)$:

$$\begin{aligned} \frac{\sin(\theta)}{1 - \cos(\theta)} &= \frac{\sin(\theta)}{(1 - \cos(\theta))} \cdot \frac{(1 + \cos(\theta))}{(1 + \cos(\theta))} = \frac{\sin(\theta)(1 + \cos(\theta))}{(1 - \cos(\theta))(1 + \cos(\theta))} \\ &= \frac{\sin(\theta)(1 + \cos(\theta))}{1 - \cos^2(\theta)} = \frac{\sin(\theta)(1 + \cos(\theta))}{\sin^2(\theta)} \\ &= \frac{\cancel{\sin(\theta)}(1 + \cos(\theta))}{\cancel{\sin(\theta)}\sin(\theta)} = \frac{1 + \cos(\theta)}{\sin(\theta)} \end{aligned}$$

□

In Example 8.3.3 number 6 above, we see that multiplying $1 - \cos(\theta)$ by $1 + \cos(\theta)$ produces a difference of squares that can be simplified to one term using Theorem 8.8. This is exactly the same kind of phenomenon that occurs when we multiply expressions such as $1 - \sqrt{2}$ by $1 + \sqrt{2}$ or $3 - 4i$ by $3 + 4i$. (Can you recall instances from Algebra where we did such things?) For this reason, the quantities $(1 - \cos(\theta))$ and $(1 + \cos(\theta))$ are called ‘Pythagorean Conjugates.’ Below is a list of other common Pythagorean Conjugates.

Pythagorean Conjugates

- $1 - \cos(\theta)$ and $1 + \cos(\theta)$: $(1 - \cos(\theta))(1 + \cos(\theta)) = 1 - \cos^2(\theta) = \sin^2(\theta)$
- $1 - \sin(\theta)$ and $1 + \sin(\theta)$: $(1 - \sin(\theta))(1 + \sin(\theta)) = 1 - \sin^2(\theta) = \cos^2(\theta)$
- $\sec(\theta) - 1$ and $\sec(\theta) + 1$: $(\sec(\theta) - 1)(\sec(\theta) + 1) = \sec^2(\theta) - 1 = \tan^2(\theta)$
- $\sec(\theta) - \tan(\theta)$ and $\sec(\theta) + \tan(\theta)$: $(\sec(\theta) - \tan(\theta))(\sec(\theta) + \tan(\theta)) = \sec^2(\theta) - \tan^2(\theta) = 1$
- $\csc(\theta) - 1$ and $\csc(\theta) + 1$: $(\csc(\theta) - 1)(\csc(\theta) + 1) = \csc^2(\theta) - 1 = \cot^2(\theta)$
- $\csc(\theta) - \cot(\theta)$ and $\csc(\theta) + \cot(\theta)$: $(\csc(\theta) - \cot(\theta))(\csc(\theta) + \cot(\theta)) = \csc^2(\theta) - \cot^2(\theta) = 1$

Verifying trigonometric identities requires a healthy mix of tenacity and inspiration. You will need to spend many hours struggling with them just to become proficient in the basics. Like many things in life, there is no short-cut here – there is no complete algorithm for verifying identities. Nevertheless, a summary of some strategies which may be helpful (depending on the situation) is provided below and ample practice is provided for you in the Exercises.

Strategies for Verifying Identities

- Try working on the more complicated side of the identity.
- Use the Reciprocal and Quotient Identities in Theorem 8.6 to write functions on one side of the identity in terms of the functions on the other side of the identity. Simplify the resulting complex fractions.
- Add rational expressions with unlike denominators by obtaining common denominators.
- Use the Pythagorean Identities in Theorem 8.8 to ‘exchange’ sines and cosines, secants and tangents, cosecants and cotangents, and simplify sums or differences of squares to one term.
- Multiply numerator **and** denominator by Pythagorean Conjugates in order to take advantage of the Pythagorean Identities in Theorem 8.8.
- If you find yourself stuck working with one side of the identity, try starting with the other side of the identity and see if you can find a way to bridge the two parts of your work.

8.3.1 BEYOND THE UNIT CIRCLE

In Section 8.2, we generalized the cosine and sine functions from coordinates on the Unit Circle to coordinates on circles of radius r . Using Theorem 8.3 in conjunction with Theorem 8.8, we generalize the remaining circular functions in kind.

Theorem 8.9. Suppose $Q(x, y)$ is the point on the terminal side of an angle θ (plotted in standard position) which lies on the circle of radius r , $x^2 + y^2 = r^2$. Then:

- $\sec(\theta) = \frac{r}{x} = \frac{\sqrt{x^2 + y^2}}{x}$, provided $x \neq 0$.
- $\csc(\theta) = \frac{r}{y} = \frac{\sqrt{x^2 + y^2}}{y}$, provided $y \neq 0$.
- $\tan(\theta) = \frac{y}{x}$, provided $x \neq 0$.
- $\cot(\theta) = \frac{x}{y}$, provided $y \neq 0$.

Example 8.3.4.

1. Suppose the terminal side of θ , when plotted in standard position, contains the point $Q(3, -4)$. Find the values of the six circular functions of θ .
2. Suppose θ is a Quadrant IV angle with $\cot(\theta) = -4$. Find the values of the five remaining circular functions of θ .

Solution.

1. Since $x = 3$ and $y = -4$, $r = \sqrt{x^2 + y^2} = \sqrt{(3)^2 + (-4)^2} = \sqrt{25} = 5$. Theorem 8.9 tells us $\cos(\theta) = \frac{3}{5}$, $\sin(\theta) = -\frac{4}{5}$, $\sec(\theta) = \frac{5}{3}$, $\csc(\theta) = -\frac{5}{4}$, $\tan(\theta) = -\frac{4}{3}$ and $\cot(\theta) = -\frac{3}{4}$.
2. In order to use Theorem 8.9, we need to find a point $Q(x, y)$ which lies on the terminal side of θ , when θ is plotted in standard position. We have that $\cot(\theta) = -4 = \frac{x}{y}$, and since θ is a Quadrant IV angle, we also know $x > 0$ and $y < 0$. Viewing $-4 = \frac{4}{-1}$, we may choose⁶ $x = 4$ and $y = -1$ so that $r = \sqrt{x^2 + y^2} = \sqrt{(4)^2 + (-1)^2} = \sqrt{17}$. Applying Theorem 8.9 once more, we find $\cos(\theta) = \frac{4}{\sqrt{17}} = \frac{4\sqrt{17}}{17}$, $\sin(\theta) = -\frac{1}{\sqrt{17}} = -\frac{\sqrt{17}}{17}$, $\sec(\theta) = \frac{\sqrt{17}}{4}$, $\csc(\theta) = -\sqrt{17}$ and $\tan(\theta) = -\frac{1}{4}$. \square

We may also specialize Theorem 8.9 to the case of acute angles θ which reside in a right triangle, as visualized below.

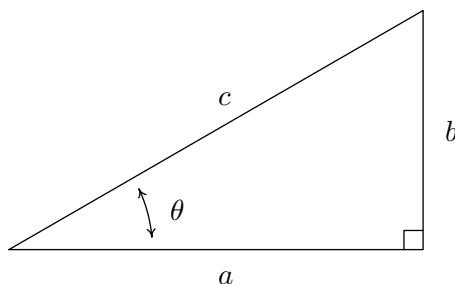

Theorem 8.10. Suppose θ is an acute angle residing in a right triangle. If the length of the side adjacent to θ is a , the length of the side opposite θ is b , and the length of the hypotenuse is c , then

$$\tan(\theta) = \frac{b}{a} \quad \sec(\theta) = \frac{c}{a} \quad \csc(\theta) = \frac{c}{b} \quad \cot(\theta) = \frac{a}{b}$$

The following example uses Theorem 8.10 as well as the concept of an ‘angle of inclination.’ The angle of inclination (or angle of elevation) of an object refers to the angle whose initial side is some kind of base-line (say, the ground), and whose terminal side is the line-of-sight to an object above the base-line. This is represented schematically below.

⁶We may choose *any* values x and y so long as $x > 0$, $y < 0$ and $\frac{x}{y} = -4$. For example, we could choose $x = 8$ and $y = -2$. The fact that all such points lie on the terminal side of θ is a consequence of the fact that the terminal side of θ is the portion of the line with slope $-\frac{1}{4}$ which extends from the origin into Quadrant IV.

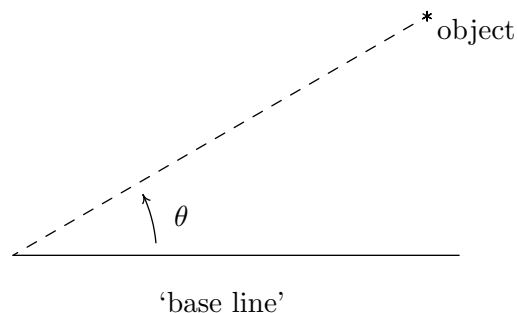

The angle of inclination from the base line to the object is θ

Example 8.3.5.

1. The angle of inclination from a point on the ground 30 feet away to the top of Lakeland’s Armington Clocktower⁷ is 60° . Find the height of the Clocktower to the nearest foot.
2. In order to determine the height of a California Redwood tree, two sightings from the ground, one 200 feet directly behind the other, are made. If the angles of inclination were 45° and 30° , respectively, how tall is the tree to the nearest foot?

Solution.

1. We can represent the problem situation using a right triangle as shown below. If we let h denote the height of the tower, then Theorem 8.10 gives $\tan(60^\circ) = \frac{h}{30}$. From this we get $h = 30 \tan(60^\circ) = 30\sqrt{3} \approx 51.96$. Hence, the Clocktower is approximately 52 feet tall.

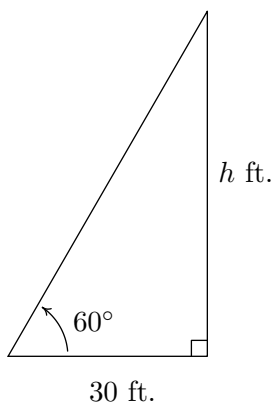

Finding the height of the Clocktower

2. Sketching the problem situation below, we find ourselves with two unknowns: the height h of the tree and the distance x from the base of the tree to the first observation point.

⁷Named in honor of Raymond Q. Armington, Lakeland’s Clocktower has been a part of campus since 1972.

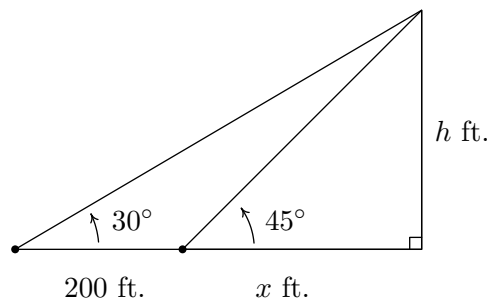

Finding the height of a California Redwood

Using Theorem 8.10, we get a pair of equations: $\tan(45^\circ) = \frac{h}{x}$ and $\tan(30^\circ) = \frac{h}{x+200}$. Since $\tan(45^\circ) = 1$, the first equation gives $\frac{h}{x} = 1$, or $x = h$. Substituting this into the second equation gives $\frac{h}{h+200} = \tan(30^\circ) = \frac{\sqrt{3}}{3}$. Clearing fractions, we get $3h = (h+200)\sqrt{3}$. The result is a linear equation for h , so we proceed to expand the right hand side and gather all the terms involving h to one side.

$$\begin{aligned} 3h &= (h+200)\sqrt{3} \\ 3h &= h\sqrt{3} + 200\sqrt{3} \\ 3h - h\sqrt{3} &= 200\sqrt{3} \\ (3 - \sqrt{3})h &= 200\sqrt{3} \\ h &= \frac{200\sqrt{3}}{3 - \sqrt{3}} \approx 273.20 \end{aligned}$$

Hence, the tree is approximately 273 feet tall. \square

As we did in Section 8.2.1, we may consider all six circular functions as functions of real numbers. At this stage, there are three equivalent ways to define the functions $\sec(t)$, $\csc(t)$, $\tan(t)$ and $\cot(t)$ for real numbers t . First, we could go through the formality of the wrapping function on page 672 and define these functions as the appropriate ratios of x and y coordinates of points on the Unit Circle; second, we could define them by associating the real number t with the angle $\theta = t$ radians so that the value of the trigonometric function of t coincides with that of θ ; lastly, we could simply define them using the Reciprocal and Quotient Identities as combinations of the functions $f(t) = \cos(t)$ and $g(t) = \sin(t)$. Presently, we adopt the last approach. We now set about determining the domains and ranges of the remaining four circular functions. Consider the function $F(t) = \sec(t)$ defined as $F(t) = \sec(t) = \frac{1}{\cos(t)}$. We know F is undefined whenever $\cos(t) = 0$. From Example 8.2.5 number 3, we know $\cos(t) = 0$ whenever $t = \frac{\pi}{2} + \pi k$ for integers k . Hence, our domain for $F(t) = \sec(t)$, in set builder notation is $\{t : t \neq \frac{\pi}{2} + \pi k, \text{ for integers } k\}$. To get a better understanding what set of real numbers we're dealing with, it pays to write out and graph this set. Running through a few values of k , we find the domain to be $\{t : t \neq \pm\frac{\pi}{2}, \pm\frac{3\pi}{2}, \pm\frac{5\pi}{2}, \dots\}$. Graphing this set on the number line we get

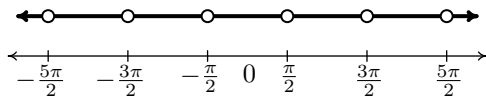

Using interval notation to describe this set, we get

$$\dots \cup \left(-\frac{5\pi}{2}, -\frac{3\pi}{2}\right) \cup \left(-\frac{3\pi}{2}, -\frac{\pi}{2}\right) \cup \left(-\frac{\pi}{2}, \frac{\pi}{2}\right) \cup \left(\frac{\pi}{2}, \frac{3\pi}{2}\right) \cup \left(\frac{3\pi}{2}, \frac{5\pi}{2}\right) \cup \dots$$

This is cumbersome, to say the least! In order to write this in a more compact way, we note that from the set-builder description of the domain, the k th point excluded from the domain, which we'll call x_k , can be found by the formula $x_k = \frac{\pi}{2} + \pi k$. Getting a common denominator and factoring out the π in the numerator, we get $x_k = \frac{(2k+1)\pi}{2}$. The domain consists of the intervals determined by successive points x_k : $(x_k, x_{k+1}) = \left(\frac{(2k+1)\pi}{2}, \frac{(2k+3)\pi}{2}\right)$. In order to capture all of the intervals in the domain, k must run through all of the integers, that is, $k = 0, \pm 1, \pm 2, \dots$. The way we denote taking the union of infinitely many intervals like this is to use what we call in this text **extended interval notation**. The domain of $F(t) = \sec(t)$ can now be written as

$$\bigcup_{k=-\infty}^{\infty} \left(\frac{(2k+1)\pi}{2}, \frac{(2k+3)\pi}{2}\right)$$

The index k in the union

$$\bigcup_{k=-\infty}^{\infty} \left(\frac{(2k+1)\pi}{2}, \frac{(2k+3)\pi}{2}\right)$$

can never actually be ∞ or $-\infty$, but rather, this conveys the idea that k ranges through all of the integers. Now that we have painstakingly determined the domain of $F(t) = \sec(t)$, it is time to discuss the range. Once again, we appeal to the definition $F(t) = \sec(t) = \frac{1}{\cos(t)}$. The range of $f(t) = \cos(t)$ is $[-1, 1]$, and since $F(t) = \sec(t)$ is undefined when $\cos(t) = 0$, we split our discussion into two cases: when $0 < \cos(t) \leq 1$ and when $-1 \leq \cos(t) < 0$. If $0 < \cos(t) \leq 1$, then we can divide the inequality $\cos(t) \leq 1$ by $\cos(t)$ to obtain $\sec(t) = \frac{1}{\cos(t)} \geq 1$. Moreover, using the notation introduced in Section 4.2, we have that as $\cos(t) \rightarrow 0^+$, $\sec(t) = \frac{1}{\cos(t)} \approx \frac{1}{\text{very small } (+)} \approx \text{very big } (+)$. In other words, as $\cos(t) \rightarrow 0^+$, $\sec(t) \rightarrow \infty$. If, on the other hand, if $-1 \leq \cos(t) < 0$, then dividing by $\cos(t)$ causes a reversal of the inequality so that $\sec(t) = \frac{1}{\cos(t)} \leq -1$. In this case, as $\cos(t) \rightarrow 0^-$, $\sec(t) = \frac{1}{\cos(t)} \approx \frac{1}{\text{very small } (-)} \approx \text{very big } (-)$, so that as $\cos(t) \rightarrow 0^-$, we get $\sec(t) \rightarrow -\infty$. Since $f(t) = \cos(t)$ admits all of the values in $[-1, 1]$, the function $F(t) = \sec(t)$ admits all of the values in $(-\infty, -1] \cup [1, \infty)$. Using set-builder notation, the range of $F(t) = \sec(t)$ can be written as $\{u : u \leq -1 \text{ or } u \geq 1\}$, or, more succinctly,⁸ as $\{u : |u| \geq 1\}$.⁹ Similar arguments can be used to determine the domains and ranges of the remaining three circular functions: $\csc(t)$, $\tan(t)$ and

⁸Using Theorem 2.4 from Section 2.4.

⁹Notice we have used the variable ' u ' as the 'dummy variable' to describe the range elements. While there is no mathematical reason to do this (we are describing a set of real numbers, and, as such, could use t again) we choose u to help solidify the idea that these real numbers are the outputs from the inputs, which we have been calling t .

$\cot(t)$. The reader is encouraged to do so. (See the Exercises.) For now, we gather these facts into the theorem below.

Theorem 8.11. Domains and Ranges of the Circular Functions

- The function $f(t) = \cos(t)$
 - has domain $(-\infty, \infty)$
 - has range $[-1, 1]$
- The function $g(t) = \sin(t)$
 - has domain $(-\infty, \infty)$
 - has range $[-1, 1]$
- The function $F(t) = \sec(t) = \frac{1}{\cos(t)}$
 - has domain $\{t : t \neq \frac{\pi}{2} + \pi k, \text{ for integers } k\} = \bigcup_{k=-\infty}^{\infty} \left(\frac{(2k+1)\pi}{2}, \frac{(2k+3)\pi}{2} \right)$
 - has range $\{u : |u| \geq 1\} = (-\infty, -1] \cup [1, \infty)$
- The function $G(t) = \csc(t) = \frac{1}{\sin(t)}$
 - has domain $\{t : t \neq \pi k, \text{ for integers } k\} = \bigcup_{k=-\infty}^{\infty} (k\pi, (k+1)\pi)$
 - has range $\{u : |u| \geq 1\} = (-\infty, -1] \cup [1, \infty)$
- The function $J(t) = \tan(t) = \frac{\sin(t)}{\cos(t)}$
 - has domain $\{t : t \neq \frac{\pi}{2} + \pi k, \text{ for integers } k\} = \bigcup_{k=-\infty}^{\infty} \left(\frac{(2k+1)\pi}{2}, \frac{(2k+3)\pi}{2} \right)$
 - has range $(-\infty, \infty)$
- The function $K(t) = \cot(t) = \frac{\cos(t)}{\sin(t)}$
 - has domain $\{t : t \neq \pi k, \text{ for integers } k\} = \bigcup_{k=-\infty}^{\infty} (k\pi, (k+1)\pi)$
 - has range $(-\infty, \infty)$

We close this section with a few notes about solving equations which involve the circular functions. First, the discussion on page 703 in Section 8.2.1 concerning solving equations applies to all six circular functions, not just $f(t) = \cos(t)$ and $g(t) = \sin(t)$. In particular, to solve the equation $\cot(t) = -1$ for real numbers t , we can use the same thought process we used in Example 8.3.2, number 3 to solve $\cot(\theta) = -1$ for angles θ in radian measure – we just need to remember to write our answers using the variable t as opposed to θ . Next, it is critical that you know the domains and ranges of the six circular functions so that you know which equations have no solutions. For example, $\sec(t) = \frac{1}{2}$ has no solution because $\frac{1}{2}$ is not in the range of secant. Finally, you will need to review the notions of reference angles and coterminal angles so that you can see why $\csc(t) = -42$ has an infinite set of solutions in Quadrant III and another infinite set of solutions in Quadrant IV.

8.3.2 EXERCISES

In Exercises 1 - 20, find the exact value or state that it is undefined.

- | | | | |
|--|--|--|---------------------------------------|
| 1. $\tan\left(\frac{\pi}{4}\right)$ | 2. $\sec\left(\frac{\pi}{6}\right)$ | 3. $\csc\left(\frac{5\pi}{6}\right)$ | 4. $\cot\left(\frac{4\pi}{3}\right)$ |
| 5. $\tan\left(-\frac{11\pi}{6}\right)$ | 6. $\sec\left(-\frac{3\pi}{2}\right)$ | 7. $\csc\left(-\frac{\pi}{3}\right)$ | 8. $\cot\left(\frac{13\pi}{2}\right)$ |
| 9. $\tan(117\pi)$ | 10. $\sec\left(-\frac{5\pi}{3}\right)$ | 11. $\csc(3\pi)$ | 12. $\cot(-5\pi)$ |
| 13. $\tan\left(\frac{31\pi}{2}\right)$ | 14. $\sec\left(\frac{\pi}{4}\right)$ | 15. $\csc\left(-\frac{7\pi}{4}\right)$ | 16. $\cot\left(\frac{7\pi}{6}\right)$ |
| 17. $\tan\left(\frac{2\pi}{3}\right)$ | 18. $\sec(-7\pi)$ | 19. $\csc\left(\frac{\pi}{2}\right)$ | 20. $\cot\left(\frac{3\pi}{4}\right)$ |

In Exercises 21 - 34, use the given the information to find the exact values of the remaining circular functions of θ .

- | | |
|--|--|
| 21. $\sin(\theta) = \frac{3}{5}$ with θ in Quadrant II | 22. $\tan(\theta) = \frac{12}{5}$ with θ in Quadrant III |
| 23. $\csc(\theta) = \frac{25}{24}$ with θ in Quadrant I | 24. $\sec(\theta) = 7$ with θ in Quadrant IV |
| 25. $\csc(\theta) = -\frac{10\sqrt{91}}{91}$ with θ in Quadrant III | 26. $\cot(\theta) = -23$ with θ in Quadrant II |
| 27. $\tan(\theta) = -2$ with θ in Quadrant IV. | 28. $\sec(\theta) = -4$ with θ in Quadrant II. |
| 29. $\cot(\theta) = \sqrt{5}$ with θ in Quadrant III. | 30. $\cos(\theta) = \frac{1}{3}$ with θ in Quadrant I. |
| 31. $\cot(\theta) = 2$ with $0 < \theta < \frac{\pi}{2}$. | 32. $\csc(\theta) = 5$ with $\frac{\pi}{2} < \theta < \pi$. |
| 33. $\tan(\theta) = \sqrt{10}$ with $\pi < \theta < \frac{3\pi}{2}$. | 34. $\sec(\theta) = 2\sqrt{5}$ with $\frac{3\pi}{2} < \theta < 2\pi$. |

In Exercises 35 - 42, use your calculator to approximate the given value to three decimal places. Make sure your calculator is in the proper angle measurement mode!

- | | | | |
|-------------------------|--------------------------|---------------------|-----------------------|
| 35. $\csc(78.95^\circ)$ | 36. $\tan(-2.01)$ | 37. $\cot(392.994)$ | 38. $\sec(207^\circ)$ |
| 39. $\csc(5.902)$ | 40. $\tan(39.672^\circ)$ | 41. $\cot(3^\circ)$ | 42. $\sec(0.45)$ |

In Exercises 43 - 57, find all of the angles which satisfy the equation.

- | | | | |
|--------------------------------|-------------------------|-----------------------------------|---|
| 43. $\tan(\theta) = \sqrt{3}$ | 44. $\sec(\theta) = 2$ | 45. $\csc(\theta) = -1$ | 46. $\cot(\theta) = \frac{\sqrt{3}}{3}$ |
| 47. $\tan(\theta) = 0$ | 48. $\sec(\theta) = 1$ | 49. $\csc(\theta) = 2$ | 50. $\cot(\theta) = 0$ |
| 51. $\tan(\theta) = -1$ | 52. $\sec(\theta) = 0$ | 53. $\csc(\theta) = -\frac{1}{2}$ | 54. $\sec(\theta) = -1$ |
| 55. $\tan(\theta) = -\sqrt{3}$ | 56. $\csc(\theta) = -2$ | 57. $\cot(\theta) = -1$ | |

In Exercises 58 - 65, solve the equation for t . Give exact values.

- | | | | |
|---------------------------|-------------------------------------|--------------------------------------|-------------------------------------|
| 58. $\cot(t) = 1$ | 59. $\tan(t) = \frac{\sqrt{3}}{3}$ | 60. $\sec(t) = -\frac{2\sqrt{3}}{3}$ | 61. $\csc(t) = 0$ |
| 62. $\cot(t) = -\sqrt{3}$ | 63. $\tan(t) = -\frac{\sqrt{3}}{3}$ | 64. $\sec(t) = \frac{2\sqrt{3}}{3}$ | 65. $\csc(t) = \frac{2\sqrt{3}}{3}$ |

In Exercises 66 - 69, use Theorem 8.10 to find the requested quantities.

66. Find θ , a , and c .

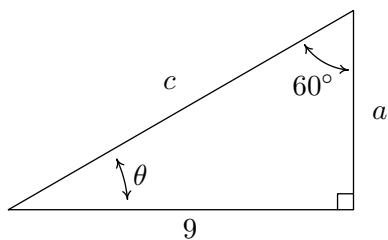

67. Find α , b , and c .

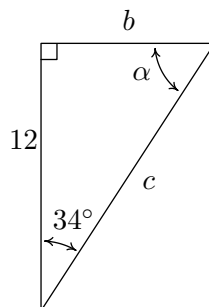

68. Find θ , a , and c .

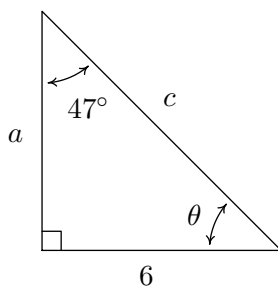

69. Find β , b , and c .

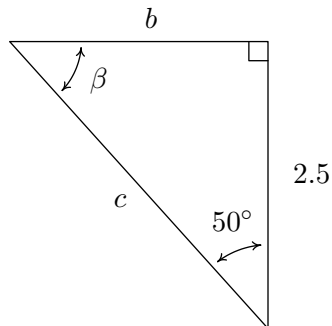

In Exercises 70 - 75, use Theorem 8.10 to answer the question. Assume that θ is an angle in a right triangle.

70. If $\theta = 30^\circ$ and the side opposite θ has length 4, how long is the side adjacent to θ ?
71. If $\theta = 15^\circ$ and the hypotenuse has length 10, how long is the side opposite θ ?
72. If $\theta = 87^\circ$ and the side adjacent to θ has length 2, how long is the side opposite θ ?
73. If $\theta = 38.2^\circ$ and the side opposite θ has length 14, how long is the hypotenuse?
74. If $\theta = 2.05^\circ$ and the hypotenuse has length 3.98, how long is the side adjacent to θ ?
75. If $\theta = 42^\circ$ and the side adjacent to θ has length 31, how long is the side opposite θ ?
76. A tree standing vertically on level ground casts a 120 foot long shadow. The angle of elevation from the end of the shadow to the top of the tree is 21.4° . Find the height of the tree to the nearest foot. With the help of your classmates, research the term *umbra versa* and see what it has to do with the shadow in this problem.
77. The broadcast tower for radio station WSAZ (Home of “Algebra in the Morning with Carl and Jeff”) has two enormous flashing red lights on it: one at the very top and one a few feet below the top. From a point 5000 feet away from the base of the tower on level ground the angle of elevation to the top light is 7.970° and to the second light is 7.125° . Find the distance between the lights to the nearest foot.
78. On page 721 we defined the angle of inclination (also known as the angle of elevation) and in this exercise we introduce a related angle - the angle of depression (also known as the angle of declination). The angle of depression of an object refers to the angle whose initial side is a horizontal line above the object and whose terminal side is the line-of-sight to the object below the horizontal. This is represented schematically below.

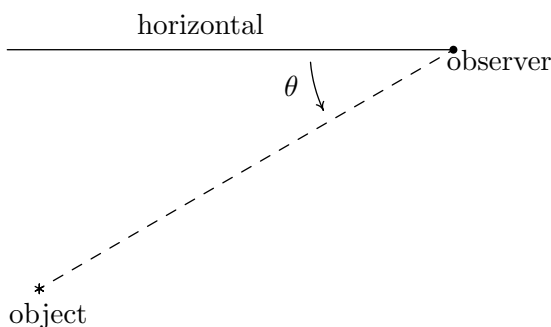

The angle of depression from the horizontal to the object is θ

- (a) Show that if the horizontal is above and parallel to level ground then the angle of depression (from observer to object) and the angle of inclination (from object to observer) will be congruent because they are alternate interior angles.

- (b) From a firetower 200 feet above level ground in the Sasquatch National Forest, a ranger spots a fire off in the distance. The angle of depression to the fire is 2.5° . How far away from the base of the tower is the fire?
- (c) The ranger in part 78b sees a Sasquatch running directly from the fire towards the firetower. The ranger takes two sightings. At the first sighting, the angle of depression from the tower to the Sasquatch is 6° . The second sighting, taken just 10 seconds later, gives the the angle of depression as 6.5° . How far did the Saquatch travel in those 10 seconds? Round your answer to the nearest foot. How fast is it running in miles per hour? Round your answer to the nearest mile per hour. If the Sasquatch keeps up this pace, how long will it take for the Sasquatch to reach the firetower from his location at the second sighting? Round your answer to the nearest minute.
79. When I stand 30 feet away from a tree at home, the angle of elevation to the top of the tree is 50° and the angle of depression to the base of the tree is 10° . What is the height of the tree? Round your answer to the nearest foot.
80. From the observation deck of the lighthouse at Sasquatch Point 50 feet above the surface of Lake Ippizuti, a lifeguard spots a boat out on the lake sailing directly toward the lighthouse. The first sighting had an angle of depression of 8.2° and the second sighting had an angle of depression of 25.9° . How far had the boat traveled between the sightings?
81. A guy wire 1000 feet long is attached to the top of a tower. When pulled taut it makes a 43° angle with the ground. How tall is the tower? How far away from the base of the tower does the wire hit the ground?

In Exercises 82 - 128, verify the identity. Assume that all quantities are defined.

82. $\cos(\theta) \sec(\theta) = 1$

83. $\tan(\theta) \cos(\theta) = \sin(\theta)$

84. $\sin(\theta) \csc(\theta) = 1$

85. $\tan(\theta) \cot(\theta) = 1$

86. $\csc(\theta) \cos(\theta) = \cot(\theta)$

87. $\frac{\sin(\theta)}{\cos^2(\theta)} = \sec(\theta) \tan(\theta)$

88. $\frac{\cos(\theta)}{\sin^2(\theta)} = \csc(\theta) \cot(\theta)$

89. $\frac{1 + \sin(\theta)}{\cos(\theta)} = \sec(\theta) + \tan(\theta)$

90. $\frac{1 - \cos(\theta)}{\sin(\theta)} = \csc(\theta) - \cot(\theta)$

91. $\frac{\cos(\theta)}{1 - \sin^2(\theta)} = \sec(\theta)$

92. $\frac{\sin(\theta)}{1 - \cos^2(\theta)} = \csc(\theta)$

93. $\frac{\sec(\theta)}{1 + \tan^2(\theta)} = \cos(\theta)$

94. $\frac{\csc(\theta)}{1 + \cot^2(\theta)} = \sin(\theta)$
95. $\frac{\tan(\theta)}{\sec^2(\theta) - 1} = \cot(\theta)$
96. $\frac{\cot(\theta)}{\csc^2(\theta) - 1} = \tan(\theta)$
97. $4 \cos^2(\theta) + 4 \sin^2(\theta) = 4$
98. $9 - \cos^2(\theta) - \sin^2(\theta) = 8$
99. $\tan^3(\theta) = \tan(\theta) \sec^2(\theta) - \tan(\theta)$
100. $\sin^5(\theta) = (1 - \cos^2(\theta))^2 \sin(\theta)$
101. $\sec^{10}(\theta) = (1 + \tan^2(\theta))^4 \sec^2(\theta)$
102. $\cos^2(\theta) \tan^3(\theta) = \tan(\theta) - \sin(\theta) \cos(\theta)$
103. $\sec^4(\theta) - \sec^2(\theta) = \tan^2(\theta) + \tan^4(\theta)$
104. $\frac{\cos(\theta) + 1}{\cos(\theta) - 1} = \frac{1 + \sec(\theta)}{1 - \sec(\theta)}$
105. $\frac{\sin(\theta) + 1}{\sin(\theta) - 1} = \frac{1 + \csc(\theta)}{1 - \csc(\theta)}$
106. $\frac{1 - \cot(\theta)}{1 + \cot(\theta)} = \frac{\tan(\theta) - 1}{\tan(\theta) + 1}$
107. $\frac{1 - \tan(\theta)}{1 + \tan(\theta)} = \frac{\cos(\theta) - \sin(\theta)}{\cos(\theta) + \sin(\theta)}$
108. $\tan(\theta) + \cot(\theta) = \sec(\theta) \csc(\theta)$
109. $\csc(\theta) - \sin(\theta) = \cot(\theta) \cos(\theta)$
110. $\cos(\theta) - \sec(\theta) = -\tan(\theta) \sin(\theta)$
111. $\cos(\theta)(\tan(\theta) + \cot(\theta)) = \csc(\theta)$
112. $\sin(\theta)(\tan(\theta) + \cot(\theta)) = \sec(\theta)$
113. $\frac{1}{1 - \cos(\theta)} + \frac{1}{1 + \cos(\theta)} = 2 \csc^2(\theta)$
114. $\frac{1}{\sec(\theta) + 1} + \frac{1}{\sec(\theta) - 1} = 2 \csc(\theta) \cot(\theta)$
115. $\frac{1}{\csc(\theta) + 1} + \frac{1}{\csc(\theta) - 1} = 2 \sec(\theta) \tan(\theta)$
116. $\frac{1}{\csc(\theta) - \cot(\theta)} - \frac{1}{\csc(\theta) + \cot(\theta)} = 2 \cot(\theta)$
117. $\frac{\cos(\theta)}{1 - \tan(\theta)} + \frac{\sin(\theta)}{1 - \cot(\theta)} = \sin(\theta) + \cos(\theta)$
118. $\frac{1}{\sec(\theta) + \tan(\theta)} = \sec(\theta) - \tan(\theta)$
119. $\frac{1}{\sec(\theta) - \tan(\theta)} = \sec(\theta) + \tan(\theta)$
120. $\frac{1}{\csc(\theta) - \cot(\theta)} = \csc(\theta) + \cot(\theta)$
121. $\frac{1}{\csc(\theta) + \cot(\theta)} = \csc(\theta) - \cot(\theta)$
122. $\frac{1}{1 - \sin(\theta)} = \sec^2(\theta) + \sec(\theta) \tan(\theta)$
123. $\frac{1}{1 + \sin(\theta)} = \sec^2(\theta) - \sec(\theta) \tan(\theta)$
124. $\frac{1}{1 - \cos(\theta)} = \csc^2(\theta) + \csc(\theta) \cot(\theta)$
125. $\frac{1}{1 + \cos(\theta)} = \csc^2(\theta) - \csc(\theta) \cot(\theta)$
126. $\frac{\cos(\theta)}{1 + \sin(\theta)} = \frac{1 - \sin(\theta)}{\cos(\theta)}$
127. $\csc(\theta) - \cot(\theta) = \frac{\sin(\theta)}{1 + \cos(\theta)}$
128. $\frac{1 - \sin(\theta)}{1 + \sin(\theta)} = (\sec(\theta) - \tan(\theta))^2$

136. Show that $\cos(\theta) < \frac{\sin(\theta)}{\theta} < 1$ also holds for $-\frac{\pi}{2} < \theta < 0$.
137. Explain why the fact that $\tan(\theta) = 3 = \frac{3}{1}$ does not mean $\sin(\theta) = 3$ and $\cos(\theta) = 1$? (See the solution to number 6 in Example 8.3.1.)

8.3.3 ANSWERS

1. $\tan\left(\frac{\pi}{4}\right) = 1$
2. $\sec\left(\frac{\pi}{6}\right) = \frac{2\sqrt{3}}{3}$
3. $\csc\left(\frac{5\pi}{6}\right) = 2$
4. $\cot\left(\frac{4\pi}{3}\right) = \frac{\sqrt{3}}{3}$
5. $\tan\left(-\frac{11\pi}{6}\right) = \frac{\sqrt{3}}{3}$
6. $\sec\left(-\frac{3\pi}{2}\right)$ is undefined
7. $\csc\left(-\frac{\pi}{3}\right) = -\frac{2\sqrt{3}}{3}$
8. $\cot\left(\frac{13\pi}{2}\right) = 0$
9. $\tan(117\pi) = 0$
10. $\sec\left(-\frac{5\pi}{3}\right) = 2$
11. $\csc(3\pi)$ is undefined
12. $\cot(-5\pi)$ is undefined
13. $\tan\left(\frac{31\pi}{2}\right)$ is undefined
14. $\sec\left(\frac{\pi}{4}\right) = \sqrt{2}$
15. $\csc\left(-\frac{7\pi}{4}\right) = \sqrt{2}$
16. $\cot\left(\frac{7\pi}{6}\right) = \sqrt{3}$
17. $\tan\left(\frac{2\pi}{3}\right) = -\sqrt{3}$
18. $\sec(-7\pi) = -1$
19. $\csc\left(\frac{\pi}{2}\right) = 1$
20. $\cot\left(\frac{3\pi}{4}\right) = -1$
21. $\sin(\theta) = \frac{3}{5}, \cos(\theta) = -\frac{4}{5}, \tan(\theta) = -\frac{3}{4}, \csc(\theta) = \frac{5}{3}, \sec(\theta) = -\frac{5}{4}, \cot(\theta) = -\frac{4}{3}$
22. $\sin(\theta) = -\frac{12}{13}, \cos(\theta) = -\frac{5}{13}, \tan(\theta) = \frac{12}{5}, \csc(\theta) = -\frac{13}{12}, \sec(\theta) = -\frac{13}{5}, \cot(\theta) = \frac{5}{12}$
23. $\sin(\theta) = \frac{24}{25}, \cos(\theta) = \frac{7}{25}, \tan(\theta) = \frac{24}{7}, \csc(\theta) = \frac{25}{24}, \sec(\theta) = \frac{25}{7}, \cot(\theta) = \frac{7}{24}$
24. $\sin(\theta) = -\frac{4\sqrt{3}}{7}, \cos(\theta) = \frac{1}{7}, \tan(\theta) = -4\sqrt{3}, \csc(\theta) = -\frac{7\sqrt{3}}{12}, \sec(\theta) = 7, \cot(\theta) = -\frac{\sqrt{3}}{12}$
25. $\sin(\theta) = -\frac{\sqrt{91}}{10}, \cos(\theta) = -\frac{3}{10}, \tan(\theta) = \frac{\sqrt{91}}{3}, \csc(\theta) = -\frac{10\sqrt{91}}{91}, \sec(\theta) = -\frac{10}{3}, \cot(\theta) = \frac{3\sqrt{91}}{91}$
26. $\sin(\theta) = \frac{\sqrt{530}}{530}, \cos(\theta) = -\frac{23\sqrt{530}}{530}, \tan(\theta) = -\frac{1}{23}, \csc(\theta) = \sqrt{530}, \sec(\theta) = -\frac{\sqrt{530}}{23}, \cot(\theta) = -23$
27. $\sin(\theta) = -\frac{2\sqrt{5}}{5}, \cos(\theta) = \frac{\sqrt{5}}{5}, \tan(\theta) = -2, \csc(\theta) = -\frac{\sqrt{5}}{2}, \sec(\theta) = \sqrt{5}, \cot(\theta) = -\frac{1}{2}$
28. $\sin(\theta) = \frac{\sqrt{15}}{4}, \cos(\theta) = -\frac{1}{4}, \tan(\theta) = -\sqrt{15}, \csc(\theta) = \frac{4\sqrt{15}}{15}, \sec(\theta) = -4, \cot(\theta) = -\frac{\sqrt{15}}{15}$
29. $\sin(\theta) = -\frac{\sqrt{6}}{6}, \cos(\theta) = -\frac{\sqrt{30}}{6}, \tan(\theta) = \frac{\sqrt{5}}{5}, \csc(\theta) = -\sqrt{6}, \sec(\theta) = -\frac{\sqrt{30}}{5}, \cot(\theta) = \sqrt{5}$
30. $\sin(\theta) = \frac{2\sqrt{2}}{3}, \cos(\theta) = \frac{1}{3}, \tan(\theta) = 2\sqrt{2}, \csc(\theta) = \frac{3\sqrt{2}}{4}, \sec(\theta) = 3, \cot(\theta) = \frac{\sqrt{2}}{4}$
31. $\sin(\theta) = \frac{\sqrt{5}}{5}, \cos(\theta) = \frac{2\sqrt{5}}{5}, \tan(\theta) = \frac{1}{2}, \csc(\theta) = \sqrt{5}, \sec(\theta) = \frac{\sqrt{5}}{2}, \cot(\theta) = 2$
32. $\sin(\theta) = \frac{1}{5}, \cos(\theta) = -\frac{2\sqrt{6}}{5}, \tan(\theta) = -\frac{\sqrt{6}}{12}, \csc(\theta) = 5, \sec(\theta) = -\frac{5\sqrt{6}}{12}, \cot(\theta) = -2\sqrt{6}$
33. $\sin(\theta) = -\frac{\sqrt{110}}{11}, \cos(\theta) = -\frac{\sqrt{11}}{11}, \tan(\theta) = \sqrt{10}, \csc(\theta) = -\frac{\sqrt{110}}{10}, \sec(\theta) = -\sqrt{11}, \cot(\theta) = \frac{\sqrt{10}}{10}$
34. $\sin(\theta) = -\frac{\sqrt{95}}{10}, \cos(\theta) = \frac{\sqrt{5}}{10}, \tan(\theta) = -\sqrt{19}, \csc(\theta) = -\frac{2\sqrt{95}}{19}, \sec(\theta) = 2\sqrt{5}, \cot(\theta) = -\frac{\sqrt{19}}{19}$

35. $\csc(78.95^\circ) \approx 1.019$
36. $\tan(-2.01) \approx 2.129$
37. $\cot(392.994) \approx 3.292$
38. $\sec(207^\circ) \approx -1.122$
39. $\csc(5.902) \approx -2.688$
40. $\tan(39.672^\circ) \approx 0.829$
41. $\cot(3^\circ) \approx 19.081$
42. $\sec(0.45) \approx 1.111$
43. $\tan(\theta) = \sqrt{3}$ when $\theta = \frac{\pi}{3} + \pi k$ for any integer k
44. $\sec(\theta) = 2$ when $\theta = \frac{\pi}{3} + 2\pi k$ or $\theta = \frac{5\pi}{3} + 2\pi k$ for any integer k
45. $\csc(\theta) = -1$ when $\theta = \frac{3\pi}{2} + 2\pi k$ for any integer k .
46. $\cot(\theta) = \frac{\sqrt{3}}{3}$ when $\theta = \frac{\pi}{3} + \pi k$ for any integer k
47. $\tan(\theta) = 0$ when $\theta = \pi k$ for any integer k
48. $\sec(\theta) = 1$ when $\theta = 2\pi k$ for any integer k
49. $\csc(\theta) = 2$ when $\theta = \frac{\pi}{6} + 2\pi k$ or $\theta = \frac{5\pi}{6} + 2\pi k$ for any integer k .
50. $\cot(\theta) = 0$ when $\theta = \frac{\pi}{2} + \pi k$ for any integer k
51. $\tan(\theta) = -1$ when $\theta = \frac{3\pi}{4} + \pi k$ for any integer k
52. $\sec(\theta) = 0$ never happens
53. $\csc(\theta) = -\frac{1}{2}$ never happens
54. $\sec(\theta) = -1$ when $\theta = \pi + 2\pi k = (2k + 1)\pi$ for any integer k
55. $\tan(\theta) = -\sqrt{3}$ when $\theta = \frac{2\pi}{3} + \pi k$ for any integer k
56. $\csc(\theta) = -2$ when $\theta = \frac{7\pi}{6} + 2\pi k$ or $\theta = \frac{11\pi}{6} + 2\pi k$ for any integer k
57. $\cot(\theta) = -1$ when $\theta = \frac{3\pi}{4} + \pi k$ for any integer k
58. $\cot(t) = 1$ when $t = \frac{\pi}{4} + \pi k$ for any integer k
59. $\tan(t) = \frac{\sqrt{3}}{3}$ when $t = \frac{\pi}{6} + \pi k$ for any integer k

60. $\sec(t) = -\frac{2\sqrt{3}}{3}$ when $t = \frac{5\pi}{6} + 2\pi k$ or $t = \frac{7\pi}{6} + 2\pi k$ for any integer k

61. $\csc(t) = 0$ never happens

62. $\cot(t) = -\sqrt{3}$ when $t = \frac{5\pi}{6} + \pi k$ for any integer k

63. $\tan(t) = -\frac{\sqrt{3}}{3}$ when $t = \frac{5\pi}{6} + \pi k$ for any integer k

64. $\sec(t) = \frac{2\sqrt{3}}{3}$ when $t = \frac{\pi}{6} + 2\pi k$ or $t = \frac{11\pi}{6} + 2\pi k$ for any integer k

65. $\csc(t) = \frac{2\sqrt{3}}{3}$ when $t = \frac{\pi}{3} + 2\pi k$ or $t = \frac{2\pi}{3} + 2\pi k$ for any integer k

66. $\theta = 30^\circ$, $a = 3\sqrt{3}$, $c = \sqrt{108} = 6\sqrt{3}$

67. $\alpha = 56^\circ$, $b = 12 \tan(34^\circ) \approx 8.094$, $c = 12 \sec(34^\circ) = \frac{12}{\cos(34^\circ)} \approx 14.475$

68. $\theta = 43^\circ$, $a = 6 \cot(47^\circ) = \frac{6}{\tan(47^\circ)} \approx 5.595$, $c = 6 \csc(47^\circ) = \frac{6}{\sin(47^\circ)} \approx 8.204$

69. $\beta = 40^\circ$, $b = 2.5 \tan(50^\circ) \approx 2.979$, $c = 2.5 \sec(50^\circ) = \frac{2.5}{\cos(50^\circ)} \approx 3.889$

70. The side adjacent to θ has length $4\sqrt{3} \approx 6.928$

71. The side opposite θ has length $10 \sin(15^\circ) \approx 2.588$

72. The side opposite θ is $2 \tan(87^\circ) \approx 38.162$

73. The hypotenuse has length $14 \csc(38.2^\circ) = \frac{14}{\sin(38.2^\circ)} \approx 22.639$

74. The side adjacent to θ has length $3.98 \cos(2.05^\circ) \approx 3.977$

75. The side opposite θ has length $31 \tan(42^\circ) \approx 27.912$

76. The tree is about 47 feet tall.

77. The lights are about 75 feet apart.

78. (b) The fire is about 4581 feet from the base of the tower.

(c) The Sasquatch ran $200 \cot(6^\circ) - 200 \cot(6.5^\circ) \approx 147$ feet in those 10 seconds. This translates to ≈ 10 miles per hour. At the scene of the second sighting, the Sasquatch was ≈ 1755 feet from the tower, which means, if it keeps up this pace, it will reach the tower in about 2 minutes.

79. The tree is about 41 feet tall.
80. The boat has traveled about 244 feet.
81. The tower is about 682 feet tall. The guy wire hits the ground about 731 feet away from the base of the tower.

8.4 TRIGONOMETRIC IDENTITIES

In Section 8.3, we saw the utility of the Pythagorean Identities in Theorem 8.8 along with the Quotient and Reciprocal Identities in Theorem 8.6. Not only did these identities help us compute the values of the circular functions for angles, they were also useful in simplifying expressions involving the circular functions. In this section, we introduce several collections of identities which have uses in this course and beyond. Our first set of identities is the ‘Even / Odd’ identities.¹

Theorem 8.12. Even / Odd Identities: For all applicable angles θ ,

- | | | |
|----------------------------------|-----------------------------------|-----------------------------------|
| • $\cos(-\theta) = \cos(\theta)$ | • $\sin(-\theta) = -\sin(\theta)$ | • $\tan(-\theta) = -\tan(\theta)$ |
| • $\sec(-\theta) = \sec(\theta)$ | • $\csc(-\theta) = -\csc(\theta)$ | • $\cot(-\theta) = -\cot(\theta)$ |

In light of the Quotient and Reciprocal Identities, Theorem 8.6, it suffices to show $\cos(-\theta) = \cos(\theta)$ and $\sin(-\theta) = -\sin(\theta)$. The remaining four circular functions can be expressed in terms of $\cos(\theta)$ and $\sin(\theta)$ so the proofs of their Even / Odd Identities are left as exercises. Consider an angle θ plotted in standard position. Let θ_0 be the angle coterminal with θ with $0 \leq \theta_0 < 2\pi$. (We can construct the angle θ_0 by rotating counter-clockwise from the positive x -axis to the terminal side of θ as pictured below.) Since θ and θ_0 are coterminal, $\cos(\theta) = \cos(\theta_0)$ and $\sin(\theta) = \sin(\theta_0)$.

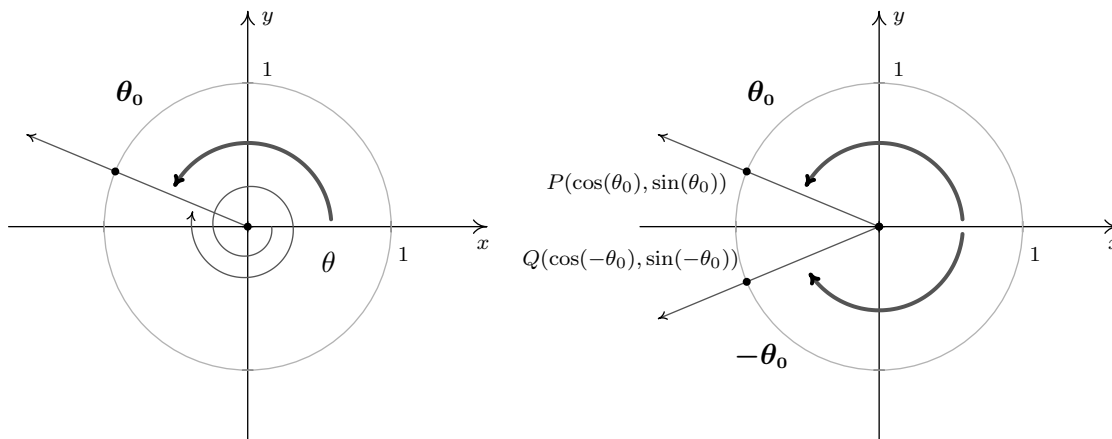

We now consider the angles $-\theta$ and $-\theta_0$. Since θ is coterminal with θ_0 , there is some integer k so that $\theta = \theta_0 + 2\pi \cdot k$. Therefore, $-\theta = -\theta_0 - 2\pi \cdot k = -\theta_0 + 2\pi \cdot (-k)$. Since k is an integer, so is $(-k)$, which means $-\theta$ is coterminal with $-\theta_0$. Hence, $\cos(-\theta) = \cos(-\theta_0)$ and $\sin(-\theta) = \sin(-\theta_0)$. Let P and Q denote the points on the terminal sides of θ_0 and $-\theta_0$, respectively, which lie on the Unit Circle. By definition, the coordinates of P are $(\cos(\theta_0), \sin(\theta_0))$ and the coordinates of Q are $(\cos(-\theta_0), \sin(-\theta_0))$. Since θ_0 and $-\theta_0$ sweep out congruent central sectors of the Unit Circle, it

¹As mentioned at the end of Section 8.2, properties of the circular functions when thought of as functions of angles in radian measure hold equally well if we view these functions as functions of real numbers. Not surprisingly, the Even / Odd properties of the circular functions are so named because they identify cosine and secant as even functions, while the remaining four circular functions are odd. (See Section 1.6.)

follows that the points P and Q are symmetric about the x -axis. Thus, $\cos(-\theta_0) = \cos(\theta_0)$ and $\sin(-\theta_0) = -\sin(\theta_0)$. Since the cosines and sines of θ_0 and $-\theta_0$ are the same as those for θ and $-\theta$, respectively, we get $\cos(-\theta) = \cos(\theta)$ and $\sin(-\theta) = -\sin(\theta)$, as required. The Even / Odd Identities are readily demonstrated using any of the ‘common angles’ noted in Section 8.2. Their true utility, however, lies not in computation, but in simplifying expressions involving the circular functions. In fact, our next batch of identities makes heavy use of the Even / Odd Identities.

Theorem 8.13. Sum and Difference Identities for Cosine: For all angles α and β ,

- $\cos(\alpha + \beta) = \cos(\alpha)\cos(\beta) - \sin(\alpha)\sin(\beta)$
- $\cos(\alpha - \beta) = \cos(\alpha)\cos(\beta) + \sin(\alpha)\sin(\beta)$

We first prove the result for differences. As in the proof of the Even / Odd Identities, we can reduce the proof for general angles α and β to angles α_0 and β_0 , coterminal with α and β , respectively, each of which measure between 0 and 2π radians. Since α and α_0 are coterminal, as are β and β_0 , it follows that $\alpha - \beta$ is coterminal with $\alpha_0 - \beta_0$. Consider the case below where $\alpha_0 \geq \beta_0$.

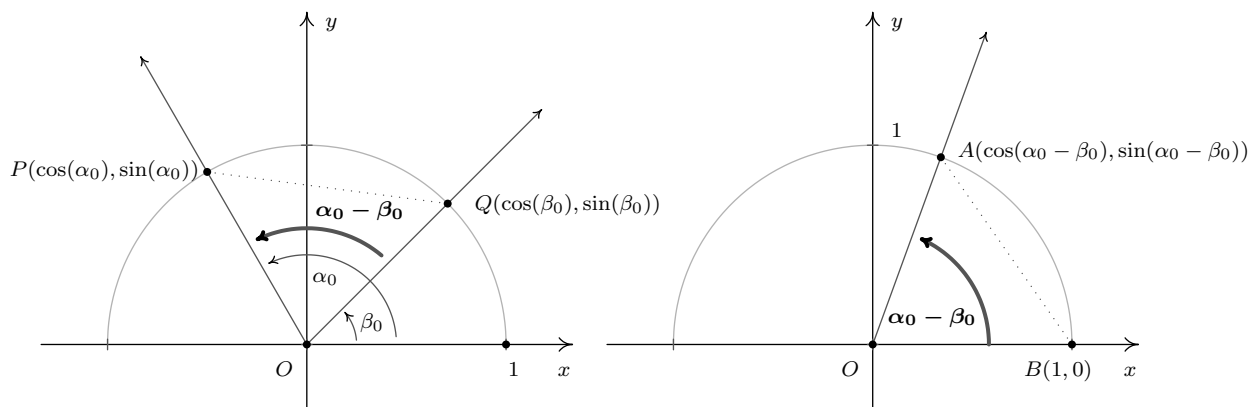

Since the angles POQ and AOB are congruent, the distance between P and Q is equal to the distance between A and B .² The distance formula, Equation 1.1, yields

$$\sqrt{(\cos(\alpha_0) - \cos(\beta_0))^2 + (\sin(\alpha_0) - \sin(\beta_0))^2} = \sqrt{(\cos(\alpha_0 - \beta_0) - 1)^2 + (\sin(\alpha_0 - \beta_0) - 0)^2}$$

Squaring both sides, we expand the left hand side of this equation as

$$\begin{aligned} (\cos(\alpha_0) - \cos(\beta_0))^2 + (\sin(\alpha_0) - \sin(\beta_0))^2 &= \cos^2(\alpha_0) - 2\cos(\alpha_0)\cos(\beta_0) + \cos^2(\beta_0) \\ &\quad + \sin^2(\alpha_0) - 2\sin(\alpha_0)\sin(\beta_0) + \sin^2(\beta_0) \\ &= \cos^2(\alpha_0) + \sin^2(\alpha_0) + \cos^2(\beta_0) + \sin^2(\beta_0) \\ &\quad - 2\cos(\alpha_0)\cos(\beta_0) - 2\sin(\alpha_0)\sin(\beta_0) \end{aligned}$$

²In the picture we've drawn, the triangles POQ and AOB are congruent, which is even better. However, $\alpha_0 - \beta_0$ could be 0 or it could be π , neither of which makes a triangle. It could also be larger than π , which makes a triangle, just not the one we've drawn. You should think about those three cases.

From the Pythagorean Identities, $\cos^2(\alpha_0) + \sin^2(\alpha_0) = 1$ and $\cos^2(\beta_0) + \sin^2(\beta_0) = 1$, so

$$(\cos(\alpha_0) - \cos(\beta_0))^2 + (\sin(\alpha_0) - \sin(\beta_0))^2 = 2 - 2\cos(\alpha_0)\cos(\beta_0) - 2\sin(\alpha_0)\sin(\beta_0)$$

Turning our attention to the right hand side of our equation, we find

$$\begin{aligned} (\cos(\alpha_0 - \beta_0) - 1)^2 + (\sin(\alpha_0 - \beta_0) - 0)^2 &= \cos^2(\alpha_0 - \beta_0) - 2\cos(\alpha_0 - \beta_0) + 1 + \sin^2(\alpha_0 - \beta_0) \\ &= 1 + \cos^2(\alpha_0 - \beta_0) + \sin^2(\alpha_0 - \beta_0) - 2\cos(\alpha_0 - \beta_0) \end{aligned}$$

Once again, we simplify $\cos^2(\alpha_0 - \beta_0) + \sin^2(\alpha_0 - \beta_0) = 1$, so that

$$(\cos(\alpha_0 - \beta_0) - 1)^2 + (\sin(\alpha_0 - \beta_0) - 0)^2 = 2 - 2\cos(\alpha_0 - \beta_0)$$

Putting it all together, we get $2 - 2\cos(\alpha_0)\cos(\beta_0) - 2\sin(\alpha_0)\sin(\beta_0) = 2 - 2\cos(\alpha_0 - \beta_0)$, which simplifies to: $\cos(\alpha_0 - \beta_0) = \cos(\alpha_0)\cos(\beta_0) + \sin(\alpha_0)\sin(\beta_0)$. Since α and α_0 , β and β_0 and $\alpha - \beta$ and $\alpha_0 - \beta_0$ are all coterminal pairs of angles, we have $\cos(\alpha - \beta) = \cos(\alpha)\cos(\beta) + \sin(\alpha)\sin(\beta)$. For the case where $\alpha_0 \leq \beta_0$, we can apply the above argument to the angle $\beta_0 - \alpha_0$ to obtain the identity $\cos(\beta_0 - \alpha_0) = \cos(\beta_0)\cos(\alpha_0) + \sin(\beta_0)\sin(\alpha_0)$. Applying the Even Identity of cosine, we get $\cos(\beta_0 - \alpha_0) = \cos(-(\alpha_0 - \beta_0)) = \cos(\alpha_0 - \beta_0)$, and we get the identity in this case, too.

To get the sum identity for cosine, we use the difference formula along with the Even/Odd Identities

$$\cos(\alpha + \beta) = \cos(\alpha - (-\beta)) = \cos(\alpha)\cos(-\beta) + \sin(\alpha)\sin(-\beta) = \cos(\alpha)\cos(\beta) - \sin(\alpha)\sin(\beta)$$

We put these newfound identities to good use in the following example.

Example 8.4.1.

1. Find the exact value of $\cos(15^\circ)$.
2. Verify the identity: $\cos\left(\frac{\pi}{2} - \theta\right) = \sin(\theta)$.

Solution.

1. In order to use Theorem 8.13 to find $\cos(15^\circ)$, we need to write 15° as a sum or difference of angles whose cosines and sines we know. One way to do so is to write $15^\circ = 45^\circ - 30^\circ$.

$$\begin{aligned} \cos(15^\circ) &= \cos(45^\circ - 30^\circ) \\ &= \cos(45^\circ)\cos(30^\circ) + \sin(45^\circ)\sin(30^\circ) \\ &= \left(\frac{\sqrt{2}}{2}\right)\left(\frac{\sqrt{3}}{2}\right) + \left(\frac{\sqrt{2}}{2}\right)\left(\frac{1}{2}\right) \\ &= \frac{\sqrt{6} + \sqrt{2}}{4} \end{aligned}$$

2. In a straightforward application of Theorem 8.13, we find

$$\begin{aligned}\cos\left(\frac{\pi}{2} - \theta\right) &= \cos\left(\frac{\pi}{2}\right)\cos(\theta) + \sin\left(\frac{\pi}{2}\right)\sin(\theta) \\ &= (0)(\cos(\theta)) + (1)(\sin(\theta)) \\ &= \sin(\theta)\end{aligned}$$

□

The identity verified in Example 8.4.1, namely, $\cos\left(\frac{\pi}{2} - \theta\right) = \sin(\theta)$, is the first of the celebrated ‘cofunction’ identities. These identities were first hinted at in Exercise 74 in Section 8.2. From $\sin(\theta) = \cos\left(\frac{\pi}{2} - \theta\right)$, we get:

$$\sin\left(\frac{\pi}{2} - \theta\right) = \cos\left(\frac{\pi}{2} - \left[\frac{\pi}{2} - \theta\right]\right) = \cos(\theta),$$

which says, in words, that the ‘co’sine of an angle is the sine of its ‘co’plement. Now that these identities have been established for cosine and sine, the remaining circular functions follow suit. The remaining proofs are left as exercises.

Theorem 8.14. Cofunction Identities: For all applicable angles θ ,

$$\begin{array}{lll}\bullet \cos\left(\frac{\pi}{2} - \theta\right) = \sin(\theta) & \bullet \sec\left(\frac{\pi}{2} - \theta\right) = \csc(\theta) & \bullet \tan\left(\frac{\pi}{2} - \theta\right) = \cot(\theta) \\ \bullet \sin\left(\frac{\pi}{2} - \theta\right) = \cos(\theta) & \bullet \csc\left(\frac{\pi}{2} - \theta\right) = \sec(\theta) & \bullet \cot\left(\frac{\pi}{2} - \theta\right) = \tan(\theta)\end{array}$$

With the Cofunction Identities in place, we are now in the position to derive the sum and difference formulas for sine. To derive the sum formula for sine, we convert to cosines using a cofunction identity, then expand using the difference formula for cosine

$$\begin{aligned}\sin(\alpha + \beta) &= \cos\left(\frac{\pi}{2} - (\alpha + \beta)\right) \\ &= \cos\left(\left[\frac{\pi}{2} - \alpha\right] - \beta\right) \\ &= \cos\left(\frac{\pi}{2} - \alpha\right)\cos(\beta) + \sin\left(\frac{\pi}{2} - \alpha\right)\sin(\beta) \\ &= \sin(\alpha)\cos(\beta) + \cos(\alpha)\sin(\beta)\end{aligned}$$

We can derive the difference formula for sine by rewriting $\sin(\alpha - \beta)$ as $\sin(\alpha + (-\beta))$ and using the sum formula and the Even / Odd Identities. Again, we leave the details to the reader.

Theorem 8.15. Sum and Difference Identities for Sine: For all angles α and β ,

$$\begin{array}{l}\bullet \sin(\alpha + \beta) = \sin(\alpha)\cos(\beta) + \cos(\alpha)\sin(\beta) \\ \bullet \sin(\alpha - \beta) = \sin(\alpha)\cos(\beta) - \cos(\alpha)\sin(\beta)\end{array}$$

Example 8.4.2.

1. Find the exact value of $\sin\left(\frac{19\pi}{12}\right)$
2. If α is a Quadrant II angle with $\sin(\alpha) = \frac{5}{13}$, and β is a Quadrant III angle with $\tan(\beta) = 2$, find $\sin(\alpha - \beta)$.
3. Derive a formula for $\tan(\alpha + \beta)$ in terms of $\tan(\alpha)$ and $\tan(\beta)$.

Solution.

1. As in Example 8.4.1, we need to write the angle $\frac{19\pi}{12}$ as a sum or difference of common angles. The denominator of 12 suggests a combination of angles with denominators 3 and 4. One such combination is $\frac{19\pi}{12} = \frac{4\pi}{3} + \frac{\pi}{4}$. Applying Theorem 8.15, we get

$$\begin{aligned} \sin\left(\frac{19\pi}{12}\right) &= \sin\left(\frac{4\pi}{3} + \frac{\pi}{4}\right) \\ &= \sin\left(\frac{4\pi}{3}\right)\cos\left(\frac{\pi}{4}\right) + \cos\left(\frac{4\pi}{3}\right)\sin\left(\frac{\pi}{4}\right) \\ &= \left(-\frac{\sqrt{3}}{2}\right)\left(\frac{\sqrt{2}}{2}\right) + \left(-\frac{1}{2}\right)\left(\frac{\sqrt{2}}{2}\right) \\ &= \frac{-\sqrt{6} - \sqrt{2}}{4} \end{aligned}$$

2. In order to find $\sin(\alpha - \beta)$ using Theorem 8.15, we need to find $\cos(\alpha)$ and both $\cos(\beta)$ and $\sin(\beta)$. To find $\cos(\alpha)$, we use the Pythagorean Identity $\cos^2(\alpha) + \sin^2(\alpha) = 1$. Since $\sin(\alpha) = \frac{5}{13}$, we have $\cos^2(\alpha) + \left(\frac{5}{13}\right)^2 = 1$, or $\cos(\alpha) = \pm\frac{12}{13}$. Since α is a Quadrant II angle, $\cos(\alpha) = -\frac{12}{13}$. We now set about finding $\cos(\beta)$ and $\sin(\beta)$. We have several ways to proceed, but the Pythagorean Identity $1 + \tan^2(\beta) = \sec^2(\beta)$ is a quick way to get $\sec(\beta)$, and hence, $\cos(\beta)$. With $\tan(\beta) = 2$, we get $1 + 2^2 = \sec^2(\beta)$ so that $\sec(\beta) = \pm\sqrt{5}$. Since β is a Quadrant III angle, we choose $\sec(\beta) = -\sqrt{5}$ so $\cos(\beta) = \frac{1}{\sec(\beta)} = \frac{1}{-\sqrt{5}} = -\frac{\sqrt{5}}{5}$. We now need to determine $\sin(\beta)$. We could use The Pythagorean Identity $\cos^2(\beta) + \sin^2(\beta) = 1$, but we opt instead to use a quotient identity. From $\tan(\beta) = \frac{\sin(\beta)}{\cos(\beta)}$, we have $\sin(\beta) = \tan(\beta)\cos(\beta)$ so we get $\sin(\beta) = (2)\left(-\frac{\sqrt{5}}{5}\right) = -\frac{2\sqrt{5}}{5}$. We now have all the pieces needed to find $\sin(\alpha - \beta)$:

$$\begin{aligned} \sin(\alpha - \beta) &= \sin(\alpha)\cos(\beta) - \cos(\alpha)\sin(\beta) \\ &= \left(\frac{5}{13}\right)\left(-\frac{\sqrt{5}}{5}\right) - \left(-\frac{12}{13}\right)\left(-\frac{2\sqrt{5}}{5}\right) \\ &= -\frac{29\sqrt{5}}{65} \end{aligned}$$

3. We can start expanding $\tan(\alpha + \beta)$ using a quotient identity and our sum formulas

$$\begin{aligned}\tan(\alpha + \beta) &= \frac{\sin(\alpha + \beta)}{\cos(\alpha + \beta)} \\ &= \frac{\sin(\alpha)\cos(\beta) + \cos(\alpha)\sin(\beta)}{\cos(\alpha)\cos(\beta) - \sin(\alpha)\sin(\beta)}\end{aligned}$$

Since $\tan(\alpha) = \frac{\sin(\alpha)}{\cos(\alpha)}$ and $\tan(\beta) = \frac{\sin(\beta)}{\cos(\beta)}$, it looks as though if we divide both numerator and denominator by $\cos(\alpha)\cos(\beta)$ we will have what we want

$$\begin{aligned}\tan(\alpha + \beta) &= \frac{\sin(\alpha)\cos(\beta) + \cos(\alpha)\sin(\beta)}{\cos(\alpha)\cos(\beta) - \sin(\alpha)\sin(\beta)} \cdot \frac{1}{\frac{1}{\cos(\alpha)\cos(\beta)}} \\ &= \frac{\frac{\sin(\alpha)\cos(\beta)}{\cos(\alpha)\cos(\beta)} + \frac{\cos(\alpha)\sin(\beta)}{\cos(\alpha)\cos(\beta)}}{\frac{\cos(\alpha)\cos(\beta)}{\cos(\alpha)\cos(\beta)} - \frac{\sin(\alpha)\sin(\beta)}{\cos(\alpha)\cos(\beta)}} \\ &= \frac{\frac{\sin(\alpha)\cancel{\cos(\beta)}}{\cancel{\cos(\alpha)}\cancel{\cos(\beta)}} + \frac{\cancel{\cos(\alpha)}\sin(\beta)}{\cancel{\cos(\alpha)}\cancel{\cos(\beta)}}}{\frac{\cancel{\cos(\alpha)}\cancel{\cos(\beta)}}{\cancel{\cos(\alpha)}\cancel{\cos(\beta)}} - \frac{\sin(\alpha)\sin(\beta)}{\cos(\alpha)\cos(\beta)}} \\ &= \frac{\tan(\alpha) + \tan(\beta)}{1 - \tan(\alpha)\tan(\beta)}\end{aligned}$$

Naturally, this formula is limited to those cases where all of the tangents are defined. \square

The formula developed in Exercise 8.4.2 for $\tan(\alpha + \beta)$ can be used to find a formula for $\tan(\alpha - \beta)$ by rewriting the difference as a sum, $\tan(\alpha + (-\beta))$, and the reader is encouraged to fill in the details. Below we summarize all of the sum and difference formulas for cosine, sine and tangent.

Theorem 8.16. Sum and Difference Identities: For all applicable angles α and β ,

- $\cos(\alpha \pm \beta) = \cos(\alpha)\cos(\beta) \mp \sin(\alpha)\sin(\beta)$
- $\sin(\alpha \pm \beta) = \sin(\alpha)\cos(\beta) \pm \cos(\alpha)\sin(\beta)$
- $\tan(\alpha \pm \beta) = \frac{\tan(\alpha) \pm \tan(\beta)}{1 \mp \tan(\alpha)\tan(\beta)}$

In the statement of Theorem 8.16, we have combined the cases for the sum ‘+’ and difference ‘-’ of angles into one formula. The convention here is that if you want the formula for the sum ‘+’ of

two angles, you use the top sign in the formula; for the difference, ‘-’, use the bottom sign. For example,

$$\tan(\alpha - \beta) = \frac{\tan(\alpha) - \tan(\beta)}{1 + \tan(\alpha)\tan(\beta)}$$

If we specialize the sum formulas in Theorem 8.16 to the case when $\alpha = \beta$, we obtain the following ‘Double Angle’ Identities.

Theorem 8.17. Double Angle Identities: For all applicable angles θ ,

$$\begin{aligned} \bullet \cos(2\theta) &= \begin{cases} \cos^2(\theta) - \sin^2(\theta) \\ 2\cos^2(\theta) - 1 \\ 1 - 2\sin^2(\theta) \end{cases} \\ \bullet \sin(2\theta) &= 2\sin(\theta)\cos(\theta) \\ \bullet \tan(2\theta) &= \frac{2\tan(\theta)}{1 - \tan^2(\theta)} \end{aligned}$$

The three different forms for $\cos(2\theta)$ can be explained by our ability to ‘exchange’ squares of cosine and sine via the Pythagorean Identity $\cos^2(\theta) + \sin^2(\theta) = 1$ and we leave the details to the reader. It is interesting to note that to determine the value of $\cos(2\theta)$, only *one* piece of information is required: either $\cos(\theta)$ or $\sin(\theta)$. To determine $\sin(2\theta)$, however, it appears that we must know both $\sin(\theta)$ and $\cos(\theta)$. In the next example, we show how we can find $\sin(2\theta)$ knowing just one piece of information, namely $\tan(\theta)$.

Example 8.4.3.

1. Suppose $P(-3, 4)$ lies on the terminal side of θ when θ is plotted in standard position. Find $\cos(2\theta)$ and $\sin(2\theta)$ and determine the quadrant in which the terminal side of the angle 2θ lies when it is plotted in standard position.
2. If $\sin(\theta) = x$ for $-\frac{\pi}{2} \leq \theta \leq \frac{\pi}{2}$, find an expression for $\sin(2\theta)$ in terms of x .
3. Verify the identity: $\sin(2\theta) = \frac{2\tan(\theta)}{1 + \tan^2(\theta)}$.
4. Express $\cos(3\theta)$ as a polynomial in terms of $\cos(\theta)$.

Solution.

1. Using Theorem 8.3 from Section 8.2 with $x = -3$ and $y = 4$, we find $r = \sqrt{x^2 + y^2} = 5$. Hence, $\cos(\theta) = -\frac{3}{5}$ and $\sin(\theta) = \frac{4}{5}$. Applying Theorem 8.17, we get $\cos(2\theta) = \cos^2(\theta) - \sin^2(\theta) = \left(-\frac{3}{5}\right)^2 - \left(\frac{4}{5}\right)^2 = -\frac{7}{25}$, and $\sin(2\theta) = 2\sin(\theta)\cos(\theta) = 2\left(\frac{4}{5}\right)\left(-\frac{3}{5}\right) = -\frac{24}{25}$. Since both cosine and sine of 2θ are negative, the terminal side of 2θ , when plotted in standard position, lies in Quadrant III.

2. If your first reaction to ‘ $\sin(\theta) = x$ ’ is ‘No it’s not, $\cos(\theta) = x$!’ then you have indeed learned something, and we take comfort in that. However, context is everything. Here, ‘ x ’ is just a variable - it does not necessarily represent the x -coordinate of the point on The Unit Circle which lies on the terminal side of θ , assuming θ is drawn in standard position. Here, x represents the quantity $\sin(\theta)$, and what we wish to know is how to express $\sin(2\theta)$ in terms of x . We will see more of this kind of thing in Section 8.6, and, as usual, this is something we need for Calculus. Since $\sin(2\theta) = 2\sin(\theta)\cos(\theta)$, we need to write $\cos(\theta)$ in terms of x to finish the problem. We substitute $x = \sin(\theta)$ into the Pythagorean Identity, $\cos^2(\theta) + \sin^2(\theta) = 1$, to get $\cos^2(\theta) + x^2 = 1$, or $\cos(\theta) = \pm\sqrt{1-x^2}$. Since $-\frac{\pi}{2} \leq \theta \leq \frac{\pi}{2}$, $\cos(\theta) \geq 0$, and thus $\cos(\theta) = \sqrt{1-x^2}$. Our final answer is $\sin(2\theta) = 2\sin(\theta)\cos(\theta) = 2x\sqrt{1-x^2}$.
3. We start with the right hand side of the identity and note that $1 + \tan^2(\theta) = \sec^2(\theta)$. From this point, we use the Reciprocal and Quotient Identities to rewrite $\tan(\theta)$ and $\sec(\theta)$ in terms of $\cos(\theta)$ and $\sin(\theta)$:

$$\begin{aligned} \frac{2\tan(\theta)}{1+\tan^2(\theta)} &= \frac{2\tan(\theta)}{\sec^2(\theta)} = \frac{2\left(\frac{\sin(\theta)}{\cos(\theta)}\right)}{\frac{1}{\cos^2(\theta)}} = 2\left(\frac{\sin(\theta)}{\cos(\theta)}\right)\cos^2(\theta) \\ &= 2\left(\frac{\sin(\theta)}{\cos(\theta)}\right)\cos(\theta)\cos(\theta) = 2\sin(\theta)\cos(\theta) = \sin(2\theta) \end{aligned}$$

4. In Theorem 8.17, one of the formulas for $\cos(2\theta)$, namely $\cos(2\theta) = 2\cos^2(\theta) - 1$, expresses $\cos(2\theta)$ as a polynomial in terms of $\cos(\theta)$. We are now asked to find such an identity for $\cos(3\theta)$. Using the sum formula for cosine, we begin with

$$\begin{aligned} \cos(3\theta) &= \cos(2\theta + \theta) \\ &= \cos(2\theta)\cos(\theta) - \sin(2\theta)\sin(\theta) \end{aligned}$$

Our ultimate goal is to express the right hand side in terms of $\cos(\theta)$ only. We substitute $\cos(2\theta) = 2\cos^2(\theta) - 1$ and $\sin(2\theta) = 2\sin(\theta)\cos(\theta)$ which yields

$$\begin{aligned} \cos(3\theta) &= \cos(2\theta)\cos(\theta) - \sin(2\theta)\sin(\theta) \\ &= (2\cos^2(\theta) - 1)\cos(\theta) - (2\sin(\theta)\cos(\theta))\sin(\theta) \\ &= 2\cos^3(\theta) - \cos(\theta) - 2\sin^2(\theta)\cos(\theta) \end{aligned}$$

Finally, we exchange $\sin^2(\theta)$ for $1 - \cos^2(\theta)$ courtesy of the Pythagorean Identity, and get

$$\begin{aligned} \cos(3\theta) &= 2\cos^3(\theta) - \cos(\theta) - 2\sin^2(\theta)\cos(\theta) \\ &= 2\cos^3(\theta) - \cos(\theta) - 2(1 - \cos^2(\theta))\cos(\theta) \\ &= 2\cos^3(\theta) - \cos(\theta) - 2\cos(\theta) + 2\cos^3(\theta) \\ &= 4\cos^3(\theta) - 3\cos(\theta) \end{aligned}$$

and we are done. □

In the last problem in Example 8.4.3, we saw how we could rewrite $\cos(3\theta)$ as sums of powers of $\cos(\theta)$. In Calculus, we have occasion to do the reverse; that is, reduce the power of cosine and sine. Solving the identity $\cos(2\theta) = 2\cos^2(\theta) - 1$ for $\cos^2(\theta)$ and the identity $\cos(2\theta) = 1 - 2\sin^2(\theta)$ for $\sin^2(\theta)$ results in the aptly-named ‘Power Reduction’ formulas below.

Theorem 8.18. Power Reduction Formulas: For all angles θ ,

- $\cos^2(\theta) = \frac{1 + \cos(2\theta)}{2}$
- $\sin^2(\theta) = \frac{1 - \cos(2\theta)}{2}$

Example 8.4.4. Rewrite $\sin^2(\theta)\cos^2(\theta)$ as a sum and difference of cosines to the first power.

Solution. We begin with a straightforward application of Theorem 8.18

$$\begin{aligned}\sin^2(\theta)\cos^2(\theta) &= \left(\frac{1 - \cos(2\theta)}{2}\right)\left(\frac{1 + \cos(2\theta)}{2}\right) \\ &= \frac{1}{4}(1 - \cos^2(2\theta)) \\ &= \frac{1}{4} - \frac{1}{4}\cos^2(2\theta)\end{aligned}$$

Next, we apply the power reduction formula to $\cos^2(2\theta)$ to finish the reduction

$$\begin{aligned}\sin^2(\theta)\cos^2(\theta) &= \frac{1}{4} - \frac{1}{4}\cos^2(2\theta) \\ &= \frac{1}{4} - \frac{1}{4}\left(\frac{1 + \cos(2(2\theta))}{2}\right) \\ &= \frac{1}{4} - \frac{1}{8} - \frac{1}{8}\cos(4\theta) \\ &= \frac{1}{8} - \frac{1}{8}\cos(4\theta)\end{aligned}$$

□

Another application of the Power Reduction Formulas is the Half Angle Formulas. To start, we apply the Power Reduction Formula to $\cos^2\left(\frac{\theta}{2}\right)$

$$\cos^2\left(\frac{\theta}{2}\right) = \frac{1 + \cos\left(2\left(\frac{\theta}{2}\right)\right)}{2} = \frac{1 + \cos(\theta)}{2}.$$

We can obtain a formula for $\cos\left(\frac{\theta}{2}\right)$ by extracting square roots. In a similar fashion, we may obtain a half angle formula for sine, and by using a quotient formula, obtain a half angle formula for tangent. We summarize these formulas below.

Theorem 8.19. Half Angle Formulas: For all applicable angles θ ,

$$\bullet \cos\left(\frac{\theta}{2}\right) = \pm\sqrt{\frac{1 + \cos(\theta)}{2}}$$

$$\bullet \sin\left(\frac{\theta}{2}\right) = \pm\sqrt{\frac{1 - \cos(\theta)}{2}}$$

$$\bullet \tan\left(\frac{\theta}{2}\right) = \pm\sqrt{\frac{1 - \cos(\theta)}{1 + \cos(\theta)}}$$

where the choice of \pm depends on the quadrant in which the terminal side of $\frac{\theta}{2}$ lies.

Example 8.4.5.

1. Use a half angle formula to find the exact value of $\cos(15^\circ)$.
2. Suppose $-\pi \leq \theta \leq 0$ with $\cos(\theta) = -\frac{3}{5}$. Find $\sin\left(\frac{\theta}{2}\right)$.
3. Use the identity given in number 3 of Example 8.4.3 to derive the identity

$$\tan\left(\frac{\theta}{2}\right) = \frac{\sin(\theta)}{1 + \cos(\theta)}$$

Solution.

1. To use the half angle formula, we note that $15^\circ = \frac{30^\circ}{2}$ and since 15° is a Quadrant I angle, its cosine is positive. Thus we have

$$\begin{aligned} \cos(15^\circ) &= +\sqrt{\frac{1 + \cos(30^\circ)}{2}} = \sqrt{\frac{1 + \frac{\sqrt{3}}{2}}{2}} \\ &= \sqrt{\frac{1 + \frac{\sqrt{3}}{2}}{2} \cdot \frac{2}{2}} = \sqrt{\frac{2 + \sqrt{3}}{4}} = \frac{\sqrt{2 + \sqrt{3}}}{2} \end{aligned}$$

Back in Example 8.4.1, we found $\cos(15^\circ)$ by using the difference formula for cosine. In that case, we determined $\cos(15^\circ) = \frac{\sqrt{6} + \sqrt{2}}{4}$. The reader is encouraged to prove that these two expressions are equal.

2. If $-\pi \leq \theta \leq 0$, then $-\frac{\pi}{2} \leq \frac{\theta}{2} \leq 0$, which means $\sin\left(\frac{\theta}{2}\right) < 0$. Theorem 8.19 gives

$$\begin{aligned} \sin\left(\frac{\theta}{2}\right) &= -\sqrt{\frac{1 - \cos(\theta)}{2}} = -\sqrt{\frac{1 - \left(-\frac{3}{5}\right)}{2}} \\ &= -\sqrt{\frac{1 + \frac{3}{5}}{2} \cdot \frac{5}{5}} = -\sqrt{\frac{8}{10}} = -\frac{2\sqrt{5}}{5} \end{aligned}$$

3. Instead of our usual approach to verifying identities, namely starting with one side of the equation and trying to transform it into the other, we will start with the identity we proved in number 3 of Example 8.4.3 and manipulate it into the identity we are asked to prove. The identity we are asked to start with is $\sin(2\theta) = \frac{2 \tan(\theta)}{1 + \tan^2(\theta)}$. If we are to use this to derive an identity for $\tan\left(\frac{\theta}{2}\right)$, it seems reasonable to proceed by replacing each occurrence of θ with $\frac{\theta}{2}$

$$\begin{aligned}\sin\left(2\left(\frac{\theta}{2}\right)\right) &= \frac{2 \tan\left(\frac{\theta}{2}\right)}{1 + \tan^2\left(\frac{\theta}{2}\right)} \\ \sin(\theta) &= \frac{2 \tan\left(\frac{\theta}{2}\right)}{1 + \tan^2\left(\frac{\theta}{2}\right)}\end{aligned}$$

We now have the $\sin(\theta)$ we need, but we somehow need to get a factor of $1 + \cos(\theta)$ involved. To get cosines involved, recall that $1 + \tan^2\left(\frac{\theta}{2}\right) = \sec^2\left(\frac{\theta}{2}\right)$. We continue to manipulate our given identity by converting secants to cosines and using a power reduction formula

$$\begin{aligned}\sin(\theta) &= \frac{2 \tan\left(\frac{\theta}{2}\right)}{1 + \tan^2\left(\frac{\theta}{2}\right)} \\ \sin(\theta) &= \frac{2 \tan\left(\frac{\theta}{2}\right)}{\sec^2\left(\frac{\theta}{2}\right)} \\ \sin(\theta) &= 2 \tan\left(\frac{\theta}{2}\right) \cos^2\left(\frac{\theta}{2}\right) \\ \sin(\theta) &= 2 \tan\left(\frac{\theta}{2}\right) \left(\frac{1 + \cos\left(2\left(\frac{\theta}{2}\right)\right)}{2}\right) \\ \sin(\theta) &= \tan\left(\frac{\theta}{2}\right) (1 + \cos(\theta)) \\ \tan\left(\frac{\theta}{2}\right) &= \frac{\sin(\theta)}{1 + \cos(\theta)}\end{aligned}$$

□

Our next batch of identities, the Product to Sum Formulas,³ are easily verified by expanding each of the right hand sides in accordance with Theorem 8.16 and as you should expect by now we leave the details as exercises. They are of particular use in Calculus, and we list them here for reference.

Theorem 8.20. Product to Sum Formulas: For all angles α and β ,

- $\cos(\alpha) \cos(\beta) = \frac{1}{2} [\cos(\alpha - \beta) + \cos(\alpha + \beta)]$
- $\sin(\alpha) \sin(\beta) = \frac{1}{2} [\cos(\alpha - \beta) - \cos(\alpha + \beta)]$
- $\sin(\alpha) \cos(\beta) = \frac{1}{2} [\sin(\alpha - \beta) + \sin(\alpha + \beta)]$

³These are also known as the Prosthaphaeresis Formulas and have a rich history. The authors recommend that you conduct some research on them as your schedule allows.

Related to the Product to Sum Formulas are the Sum to Product Formulas, which we will have need of in Section 8.7. These are easily verified using the Product to Sum Formulas, and as such, their proofs are left as exercises.

Theorem 8.21. Sum to Product Formulas: For all angles α and β ,

- $\cos(\alpha) + \cos(\beta) = 2 \cos\left(\frac{\alpha + \beta}{2}\right) \cos\left(\frac{\alpha - \beta}{2}\right)$
- $\cos(\alpha) - \cos(\beta) = -2 \sin\left(\frac{\alpha + \beta}{2}\right) \sin\left(\frac{\alpha - \beta}{2}\right)$
- $\sin(\alpha) \pm \sin(\beta) = 2 \sin\left(\frac{\alpha \pm \beta}{2}\right) \cos\left(\frac{\alpha \mp \beta}{2}\right)$

Example 8.4.6.

1. Write $\cos(2\theta)\cos(6\theta)$ as a sum.
2. Write $\sin(\theta) - \sin(3\theta)$ as a product.

Solution.

1. Identifying $\alpha = 2\theta$ and $\beta = 6\theta$, we find

$$\begin{aligned} \cos(2\theta)\cos(6\theta) &= \frac{1}{2} [\cos(2\theta - 6\theta) + \cos(2\theta + 6\theta)] \\ &= \frac{1}{2} \cos(-4\theta) + \frac{1}{2} \cos(8\theta) \\ &= \frac{1}{2} \cos(4\theta) + \frac{1}{2} \cos(8\theta), \end{aligned}$$

where the last equality is courtesy of the even identity for cosine, $\cos(-4\theta) = \cos(4\theta)$.

2. Identifying $\alpha = \theta$ and $\beta = 3\theta$ yields

$$\begin{aligned} \sin(\theta) - \sin(3\theta) &= 2 \sin\left(\frac{\theta - 3\theta}{2}\right) \cos\left(\frac{\theta + 3\theta}{2}\right) \\ &= 2 \sin(-\theta) \cos(2\theta) \\ &= -2 \sin(\theta) \cos(2\theta), \end{aligned}$$

where the last equality is courtesy of the odd identity for sine, $\sin(-\theta) = -\sin(\theta)$. □

The reader is reminded that all of the identities presented in this section which regard the circular functions as functions of angles (in radian measure) apply equally well to the circular (trigonometric) functions regarded as functions of real numbers. In Exercises 38 - 43 in Section 8.5, we see how some of these identities manifest themselves geometrically as we study the graphs of these functions. In the upcoming Exercises, however, you need to do all of your work analytically without graphs.

8.4.1 EXERCISES

In Exercises 1 - 6, use the Even / Odd Identities to verify the identity. Assume all quantities are defined.

- | | |
|---|---|
| 1. $\sin(3\pi - 2\theta) = -\sin(2\theta - 3\pi)$ | 2. $\cos\left(-\frac{\pi}{4} - 5t\right) = \cos\left(5t + \frac{\pi}{4}\right)$ |
| 3. $\tan(-t^2 + 1) = -\tan(t^2 - 1)$ | 4. $\csc(-\theta - 5) = -\csc(\theta + 5)$ |
| 5. $\sec(-6t) = \sec(6t)$ | 6. $\cot(9 - 7\theta) = -\cot(7\theta - 9)$ |

In Exercises 7 - 21, use the Sum and Difference Identities to find the exact value. You may have need of the Quotient, Reciprocal or Even / Odd Identities as well.

- | | | |
|---|---|---|
| 7. $\cos(75^\circ)$ | 8. $\sec(165^\circ)$ | 9. $\sin(105^\circ)$ |
| 10. $\csc(195^\circ)$ | 11. $\cot(255^\circ)$ | 12. $\tan(375^\circ)$ |
| 13. $\cos\left(\frac{13\pi}{12}\right)$ | 14. $\sin\left(\frac{11\pi}{12}\right)$ | 15. $\tan\left(\frac{13\pi}{12}\right)$ |
| 16. $\cos\left(\frac{7\pi}{12}\right)$ | 17. $\tan\left(\frac{17\pi}{12}\right)$ | 18. $\sin\left(\frac{\pi}{12}\right)$ |
| 19. $\cot\left(\frac{11\pi}{12}\right)$ | 20. $\csc\left(\frac{5\pi}{12}\right)$ | 21. $\sec\left(-\frac{\pi}{12}\right)$ |

22. If α is a Quadrant IV angle with $\cos(\alpha) = \frac{\sqrt{5}}{5}$, and $\sin(\beta) = \frac{\sqrt{10}}{10}$, where $\frac{\pi}{2} < \beta < \pi$, find

- | | | |
|----------------------------|----------------------------|----------------------------|
| (a) $\cos(\alpha + \beta)$ | (b) $\sin(\alpha + \beta)$ | (c) $\tan(\alpha + \beta)$ |
| (d) $\cos(\alpha - \beta)$ | (e) $\sin(\alpha - \beta)$ | (f) $\tan(\alpha - \beta)$ |

23. If $\csc(\alpha) = 3$, where $0 < \alpha < \frac{\pi}{2}$, and β is a Quadrant II angle with $\tan(\beta) = -7$, find

- | | | |
|----------------------------|----------------------------|----------------------------|
| (a) $\cos(\alpha + \beta)$ | (b) $\sin(\alpha + \beta)$ | (c) $\tan(\alpha + \beta)$ |
| (d) $\cos(\alpha - \beta)$ | (e) $\sin(\alpha - \beta)$ | (f) $\tan(\alpha - \beta)$ |

24. If $\sin(\alpha) = \frac{3}{5}$, where $0 < \alpha < \frac{\pi}{2}$, and $\cos(\beta) = \frac{12}{13}$ where $\frac{3\pi}{2} < \beta < 2\pi$, find

- | | | |
|----------------------------|----------------------------|----------------------------|
| (a) $\sin(\alpha + \beta)$ | (b) $\cos(\alpha - \beta)$ | (c) $\tan(\alpha - \beta)$ |
|----------------------------|----------------------------|----------------------------|

25. If $\sec(\alpha) = -\frac{5}{3}$, where $\frac{\pi}{2} < \alpha < \pi$, and $\tan(\beta) = \frac{24}{7}$, where $\pi < \beta < \frac{3\pi}{2}$, find

(a) $\csc(\alpha - \beta)$

(b) $\sec(\alpha + \beta)$

(c) $\cot(\alpha + \beta)$

In Exercises 26 - 38, verify the identity.

26. $\cos(\theta - \pi) = -\cos(\theta)$

27. $\sin(\pi - \theta) = \sin(\theta)$

28. $\tan\left(\theta + \frac{\pi}{2}\right) = -\cot(\theta)$

29. $\sin(\alpha + \beta) + \sin(\alpha - \beta) = 2\sin(\alpha)\cos(\beta)$

30. $\sin(\alpha + \beta) - \sin(\alpha - \beta) = 2\cos(\alpha)\sin(\beta)$

31. $\cos(\alpha + \beta) + \cos(\alpha - \beta) = 2\cos(\alpha)\cos(\beta)$

32. $\cos(\alpha + \beta) - \cos(\alpha - \beta) = -2\sin(\alpha)\sin(\beta)$

33. $\frac{\sin(\alpha + \beta)}{\sin(\alpha - \beta)} = \frac{1 + \cot(\alpha)\tan(\beta)}{1 - \cot(\alpha)\tan(\beta)}$

34. $\frac{\cos(\alpha + \beta)}{\cos(\alpha - \beta)} = \frac{1 - \tan(\alpha)\tan(\beta)}{1 + \tan(\alpha)\tan(\beta)}$

35. $\frac{\tan(\alpha + \beta)}{\tan(\alpha - \beta)} = \frac{\sin(\alpha)\cos(\alpha) + \sin(\beta)\cos(\beta)}{\sin(\alpha)\cos(\alpha) - \sin(\beta)\cos(\beta)}$

36. $\frac{\sin(t+h) - \sin(t)}{h} = \cos(t)\left(\frac{\sin(h)}{h}\right) + \sin(t)\left(\frac{\cos(h) - 1}{h}\right)$

37. $\frac{\cos(t+h) - \cos(t)}{h} = \cos(t)\left(\frac{\cos(h) - 1}{h}\right) - \sin(t)\left(\frac{\sin(h)}{h}\right)$

38. $\frac{\tan(t+h) - \tan(t)}{h} = \left(\frac{\tan(h)}{h}\right)\left(\frac{\sec^2(t)}{1 - \tan(t)\tan(h)}\right)$

In Exercises 39 - 48, use the Half Angle Formulas to find the exact value. You may have need of the Quotient, Reciprocal or Even / Odd Identities as well.

39. $\cos(75^\circ)$ (compare with Exercise 7)

40. $\sin(105^\circ)$ (compare with Exercise 9)

41. $\cos(67.5^\circ)$

42. $\sin(157.5^\circ)$

43. $\tan(112.5^\circ)$

44. $\cos\left(\frac{7\pi}{12}\right)$ (compare with Exercise 16)

45. $\sin\left(\frac{\pi}{12}\right)$ (compare with Exercise 18)

46. $\cos\left(\frac{\pi}{8}\right)$

47. $\sin\left(\frac{5\pi}{8}\right)$

48. $\tan\left(\frac{7\pi}{8}\right)$

In Exercises 49 - 58, use the given information about θ to find the exact values of

$$\bullet \sin(2\theta)$$

$$\bullet \cos(2\theta)$$

$$\bullet \tan(2\theta)$$

$$\bullet \sin\left(\frac{\theta}{2}\right)$$

$$\bullet \cos\left(\frac{\theta}{2}\right)$$

$$\bullet \tan\left(\frac{\theta}{2}\right)$$

$$49. \sin(\theta) = -\frac{7}{25} \text{ where } \frac{3\pi}{2} < \theta < 2\pi$$

$$50. \cos(\theta) = \frac{28}{53} \text{ where } 0 < \theta < \frac{\pi}{2}$$

$$51. \tan(\theta) = \frac{12}{5} \text{ where } \pi < \theta < \frac{3\pi}{2}$$

$$52. \csc(\theta) = 4 \text{ where } \frac{\pi}{2} < \theta < \pi$$

$$53. \cos(\theta) = \frac{3}{5} \text{ where } 0 < \theta < \frac{\pi}{2}$$

$$54. \sin(\theta) = -\frac{4}{5} \text{ where } \pi < \theta < \frac{3\pi}{2}$$

$$55. \cos(\theta) = \frac{12}{13} \text{ where } \frac{3\pi}{2} < \theta < 2\pi$$

$$56. \sin(\theta) = \frac{5}{13} \text{ where } \frac{\pi}{2} < \theta < \pi$$

$$57. \sec(\theta) = \sqrt{5} \text{ where } \frac{3\pi}{2} < \theta < 2\pi$$

$$58. \tan(\theta) = -2 \text{ where } \frac{\pi}{2} < \theta < \pi$$

In Exercises 59 - 73, verify the identity. Assume all quantities are defined.

$$59. (\cos(\theta) + \sin(\theta))^2 = 1 + \sin(2\theta)$$

$$60. (\cos(\theta) - \sin(\theta))^2 = 1 - \sin(2\theta)$$

$$61. \tan(2\theta) = \frac{1}{1 - \tan(\theta)} - \frac{1}{1 + \tan(\theta)}$$

$$62. \csc(2\theta) = \frac{\cot(\theta) + \tan(\theta)}{2}$$

$$63. 8 \sin^4(\theta) = \cos(4\theta) - 4 \cos(2\theta) + 3$$

$$64. 8 \cos^4(\theta) = \cos(4\theta) + 4 \cos(2\theta) + 3$$

$$65. \sin(3\theta) = 3 \sin(\theta) - 4 \sin^3(\theta)$$

$$66. \sin(4\theta) = 4 \sin(\theta) \cos^3(\theta) - 4 \sin^3(\theta) \cos(\theta)$$

$$67. 32 \sin^2(\theta) \cos^4(\theta) = 2 + \cos(2\theta) - 2 \cos(4\theta) - \cos(6\theta)$$

$$68. 32 \sin^4(\theta) \cos^2(\theta) = 2 - \cos(2\theta) - 2 \cos(4\theta) + \cos(6\theta)$$

$$69. \cos(4\theta) = 8 \cos^4(\theta) - 8 \cos^2(\theta) + 1$$

$$70. \cos(8\theta) = 128 \cos^8(\theta) - 256 \cos^6(\theta) + 160 \cos^4(\theta) - 32 \cos^2(\theta) + 1 \text{ (HINT: Use the result to 69.)}$$

$$71. \sec(2\theta) = \frac{\cos(\theta)}{\cos(\theta) + \sin(\theta)} + \frac{\sin(\theta)}{\cos(\theta) - \sin(\theta)}$$

$$72. \frac{1}{\cos(\theta) - \sin(\theta)} + \frac{1}{\cos(\theta) + \sin(\theta)} = \frac{2 \cos(\theta)}{\cos(2\theta)}$$

$$73. \frac{1}{\cos(\theta) - \sin(\theta)} - \frac{1}{\cos(\theta) + \sin(\theta)} = \frac{2 \sin(\theta)}{\cos(2\theta)}$$

In Exercises 74 - 79, write the given product as a sum. You may need to use an Even/Odd Identity.

74. $\cos(3\theta) \cos(5\theta)$

75. $\sin(2\theta) \sin(7\theta)$

76. $\sin(9\theta) \cos(\theta)$

77. $\cos(2\theta) \cos(6\theta)$

78. $\sin(3\theta) \sin(2\theta)$

79. $\cos(\theta) \sin(3\theta)$

In Exercises 80 - 85, write the given sum as a product. You may need to use an Even/Odd or Cofunction Identity.

80. $\cos(3\theta) + \cos(5\theta)$

81. $\sin(2\theta) - \sin(7\theta)$

82. $\cos(5\theta) - \cos(6\theta)$

83. $\sin(9\theta) - \sin(-\theta)$

84. $\sin(\theta) + \cos(\theta)$

85. $\cos(\theta) - \sin(\theta)$

86. Suppose θ is a Quadrant I angle with $\sin(\theta) = x$. Verify the following formulas

(a) $\cos(\theta) = \sqrt{1 - x^2}$

(b) $\sin(2\theta) = 2x\sqrt{1 - x^2}$

(c) $\cos(2\theta) = 1 - 2x^2$

87. Discuss with your classmates how each of the formulas, if any, in Exercise 86 change if we change assume θ is a Quadrant II, III, or IV angle.

88. Suppose θ is a Quadrant I angle with $\tan(\theta) = x$. Verify the following formulas

(a) $\cos(\theta) = \frac{1}{\sqrt{x^2 + 1}}$

(b) $\sin(\theta) = \frac{x}{\sqrt{x^2 + 1}}$

(c) $\sin(2\theta) = \frac{2x}{x^2 + 1}$

(d) $\cos(2\theta) = \frac{1 - x^2}{x^2 + 1}$

89. Discuss with your classmates how each of the formulas, if any, in Exercise 88 change if we change assume θ is a Quadrant II, III, or IV angle.

90. If $\sin(\theta) = \frac{x}{2}$ for $-\frac{\pi}{2} < \theta < \frac{\pi}{2}$, find an expression for $\cos(2\theta)$ in terms of x .

91. If $\tan(\theta) = \frac{x}{7}$ for $-\frac{\pi}{2} < \theta < \frac{\pi}{2}$, find an expression for $\sin(2\theta)$ in terms of x .

92. If $\sec(\theta) = \frac{x}{4}$ for $0 < \theta < \frac{\pi}{2}$, find an expression for $\ln|\sec(\theta) + \tan(\theta)|$ in terms of x .

93. Show that $\cos^2(\theta) - \sin^2(\theta) = 2\cos^2(\theta) - 1 = 1 - 2\sin^2(\theta)$ for all θ .

94. Let θ be a Quadrant III angle with $\cos(\theta) = -\frac{1}{5}$. Show that this is not enough information to determine the sign of $\sin\left(\frac{\theta}{2}\right)$ by first assuming $3\pi < \theta < \frac{7\pi}{2}$ and then assuming $\pi < \theta < \frac{3\pi}{2}$ and computing $\sin\left(\frac{\theta}{2}\right)$ in both cases.

95. Without using your calculator, show that $\frac{\sqrt{2 + \sqrt{3}}}{2} = \frac{\sqrt{6} + \sqrt{2}}{4}$
96. In part 4 of Example 8.4.3, we wrote $\cos(3\theta)$ as a polynomial in terms of $\cos(\theta)$. In Exercise 69, we had you verify an identity which expresses $\cos(4\theta)$ as a polynomial in terms of $\cos(\theta)$. Can you find a polynomial in terms of $\cos(\theta)$ for $\cos(5\theta)$? $\cos(6\theta)$? Can you find a pattern so that $\cos(n\theta)$ could be written as a polynomial in cosine for any natural number n ?
97. In Exercise 65, we had you verify an identity which expresses $\sin(3\theta)$ as a polynomial in terms of $\sin(\theta)$. Can you do the same for $\sin(5\theta)$? What about for $\sin(4\theta)$? If not, what goes wrong?
98. Verify the Even / Odd Identities for tangent, secant, cosecant and cotangent.
99. Verify the Cofunction Identities for tangent, secant, cosecant and cotangent.
100. Verify the Difference Identities for sine and tangent.
101. Verify the Product to Sum Identities.
102. Verify the Sum to Product Identities.

8.4.2 ANSWERS

7. $\cos(75^\circ) = \frac{\sqrt{6} - \sqrt{2}}{4}$

8. $\sec(165^\circ) = -\frac{4}{\sqrt{2} + \sqrt{6}} = \sqrt{2} - \sqrt{6}$

9. $\sin(105^\circ) = \frac{\sqrt{6} + \sqrt{2}}{4}$

10. $\csc(195^\circ) = \frac{4}{\sqrt{2} - \sqrt{6}} = -(\sqrt{2} + \sqrt{6})$

11. $\cot(255^\circ) = \frac{\sqrt{3} - 1}{\sqrt{3} + 1} = 2 - \sqrt{3}$

12. $\tan(375^\circ) = \frac{3 - \sqrt{3}}{3 + \sqrt{3}} = 2 - \sqrt{3}$

13. $\cos\left(\frac{13\pi}{12}\right) = -\frac{\sqrt{6} + \sqrt{2}}{4}$

14. $\sin\left(\frac{11\pi}{12}\right) = \frac{\sqrt{6} - \sqrt{2}}{4}$

15. $\tan\left(\frac{13\pi}{12}\right) = \frac{3 - \sqrt{3}}{3 + \sqrt{3}} = 2 - \sqrt{3}$

16. $\cos\left(\frac{7\pi}{12}\right) = \frac{\sqrt{2} - \sqrt{6}}{4}$

17. $\tan\left(\frac{17\pi}{12}\right) = 2 + \sqrt{3}$

18. $\sin\left(\frac{\pi}{12}\right) = \frac{\sqrt{6} - \sqrt{2}}{4}$

19. $\cot\left(\frac{11\pi}{12}\right) = -(2 + \sqrt{3})$

20. $\csc\left(\frac{5\pi}{12}\right) = \sqrt{6} - \sqrt{2}$

21. $\sec\left(-\frac{\pi}{12}\right) = \sqrt{6} - \sqrt{2}$

22. (a) $\cos(\alpha + \beta) = -\frac{\sqrt{2}}{10}$

(b) $\sin(\alpha + \beta) = \frac{7\sqrt{2}}{10}$

(c) $\tan(\alpha + \beta) = -7$

(d) $\cos(\alpha - \beta) = -\frac{\sqrt{2}}{2}$

(e) $\sin(\alpha - \beta) = \frac{\sqrt{2}}{2}$

(f) $\tan(\alpha - \beta) = -1$

23. (a) $\cos(\alpha + \beta) = -\frac{4 + 7\sqrt{2}}{30}$

(b) $\sin(\alpha + \beta) = \frac{28 - \sqrt{2}}{30}$

(c) $\tan(\alpha + \beta) = \frac{-28 + \sqrt{2}}{4 + 7\sqrt{2}} = \frac{63 - 100\sqrt{2}}{41}$

(d) $\cos(\alpha - \beta) = \frac{-4 + 7\sqrt{2}}{30}$

(e) $\sin(\alpha - \beta) = -\frac{28 + \sqrt{2}}{30}$

(f) $\tan(\alpha - \beta) = \frac{28 + \sqrt{2}}{4 - 7\sqrt{2}} = -\frac{63 + 100\sqrt{2}}{41}$

24. (a) $\sin(\alpha + \beta) = \frac{16}{65}$

(b) $\cos(\alpha - \beta) = \frac{33}{65}$

(c) $\tan(\alpha - \beta) = \frac{56}{33}$

$$25. \quad (a) \csc(\alpha - \beta) = -\frac{5}{4} \qquad (b) \sec(\alpha + \beta) = \frac{125}{117} \qquad (c) \cot(\alpha + \beta) = \frac{117}{44}$$

$$39. \cos(75^\circ) = \frac{\sqrt{2 - \sqrt{3}}}{2} \qquad 40. \sin(105^\circ) = \frac{\sqrt{2 + \sqrt{3}}}{2}$$

$$41. \cos(67.5^\circ) = \frac{\sqrt{2 - \sqrt{2}}}{2} \qquad 42. \sin(157.5^\circ) = \frac{\sqrt{2 - \sqrt{2}}}{2}$$

$$43. \tan(112.5^\circ) = -\sqrt{\frac{2 + \sqrt{2}}{2 - \sqrt{2}}} = -1 - \sqrt{2} \qquad 44. \cos\left(\frac{7\pi}{12}\right) = -\frac{\sqrt{2 - \sqrt{3}}}{2}$$

$$45. \sin\left(\frac{\pi}{12}\right) = \frac{\sqrt{2 - \sqrt{3}}}{2} \qquad 46. \cos\left(\frac{\pi}{8}\right) = \frac{\sqrt{2 + \sqrt{2}}}{2}$$

$$47. \sin\left(\frac{5\pi}{8}\right) = \frac{\sqrt{2 + \sqrt{2}}}{2} \qquad 48. \tan\left(\frac{7\pi}{8}\right) = -\sqrt{\frac{2 - \sqrt{2}}{2 + \sqrt{2}}} = 1 - \sqrt{2}$$

$$49. \quad \bullet \sin(2\theta) = -\frac{336}{625} \qquad \bullet \cos(2\theta) = \frac{527}{625} \qquad \bullet \tan(2\theta) = -\frac{336}{527}$$

$$\bullet \sin\left(\frac{\theta}{2}\right) = \frac{\sqrt{2}}{10} \qquad \bullet \cos\left(\frac{\theta}{2}\right) = -\frac{7\sqrt{2}}{10} \qquad \bullet \tan\left(\frac{\theta}{2}\right) = -\frac{1}{7}$$

$$50. \quad \bullet \sin(2\theta) = \frac{2520}{2809} \qquad \bullet \cos(2\theta) = -\frac{1241}{2809} \qquad \bullet \tan(2\theta) = -\frac{2520}{1241}$$

$$\bullet \sin\left(\frac{\theta}{2}\right) = \frac{5\sqrt{106}}{106} \qquad \bullet \cos\left(\frac{\theta}{2}\right) = \frac{9\sqrt{106}}{106} \qquad \bullet \tan\left(\frac{\theta}{2}\right) = \frac{5}{9}$$

$$51. \quad \bullet \sin(2\theta) = \frac{120}{169} \qquad \bullet \cos(2\theta) = -\frac{119}{169} \qquad \bullet \tan(2\theta) = -\frac{120}{119}$$

$$\bullet \sin\left(\frac{\theta}{2}\right) = \frac{3\sqrt{13}}{13} \qquad \bullet \cos\left(\frac{\theta}{2}\right) = -\frac{2\sqrt{13}}{13} \qquad \bullet \tan\left(\frac{\theta}{2}\right) = -\frac{3}{2}$$

$$52. \quad \bullet \sin(2\theta) = -\frac{\sqrt{15}}{8} \qquad \bullet \cos(2\theta) = \frac{7}{8} \qquad \bullet \tan(2\theta) = -\frac{\sqrt{15}}{7}$$

$$\bullet \sin\left(\frac{\theta}{2}\right) = \frac{\sqrt{8 + 2\sqrt{15}}}{4} \qquad \bullet \cos\left(\frac{\theta}{2}\right) = \frac{\sqrt{8 - 2\sqrt{15}}}{4} \qquad \bullet \tan\left(\frac{\theta}{2}\right) = \sqrt{\frac{8 + 2\sqrt{15}}{8 - 2\sqrt{15}}}$$

$$\tan\left(\frac{\theta}{2}\right) = 4 + \sqrt{15}$$

$$53. \quad \bullet \sin(2\theta) = \frac{24}{25} \qquad \bullet \cos(2\theta) = -\frac{7}{25} \qquad \bullet \tan(2\theta) = -\frac{24}{7}$$

$$\bullet \sin\left(\frac{\theta}{2}\right) = \frac{\sqrt{5}}{5} \qquad \bullet \cos\left(\frac{\theta}{2}\right) = \frac{2\sqrt{5}}{5} \qquad \bullet \tan\left(\frac{\theta}{2}\right) = \frac{1}{2}$$

54. $\bullet \sin(2\theta) = \frac{24}{25}$ $\bullet \cos(2\theta) = -\frac{7}{25}$ $\bullet \tan(2\theta) = -\frac{24}{7}$
 $\bullet \sin\left(\frac{\theta}{2}\right) = \frac{2\sqrt{5}}{5}$ $\bullet \cos\left(\frac{\theta}{2}\right) = -\frac{\sqrt{5}}{5}$ $\bullet \tan\left(\frac{\theta}{2}\right) = -2$
55. $\bullet \sin(2\theta) = -\frac{120}{169}$ $\bullet \cos(2\theta) = \frac{119}{169}$ $\bullet \tan(2\theta) = -\frac{120}{119}$
 $\bullet \sin\left(\frac{\theta}{2}\right) = \frac{\sqrt{26}}{26}$ $\bullet \cos\left(\frac{\theta}{2}\right) = -\frac{5\sqrt{26}}{26}$ $\bullet \tan\left(\frac{\theta}{2}\right) = -\frac{1}{5}$
56. $\bullet \sin(2\theta) = -\frac{120}{169}$ $\bullet \cos(2\theta) = \frac{119}{169}$ $\bullet \tan(2\theta) = -\frac{120}{119}$
 $\bullet \sin\left(\frac{\theta}{2}\right) = \frac{5\sqrt{26}}{26}$ $\bullet \cos\left(\frac{\theta}{2}\right) = \frac{\sqrt{26}}{26}$ $\bullet \tan\left(\frac{\theta}{2}\right) = 5$
57. $\bullet \sin(2\theta) = -\frac{4}{5}$ $\bullet \cos(2\theta) = -\frac{3}{5}$ $\bullet \tan(2\theta) = \frac{4}{3}$
 $\bullet \sin\left(\frac{\theta}{2}\right) = \frac{\sqrt{50 - 10\sqrt{5}}}{10}$ $\bullet \cos\left(\frac{\theta}{2}\right) = -\frac{\sqrt{50 + 10\sqrt{5}}}{10}$ $\bullet \tan\left(\frac{\theta}{2}\right) = -\sqrt{\frac{5 - \sqrt{5}}{5 + \sqrt{5}}}$
 $\tan\left(\frac{\theta}{2}\right) = \frac{5 - 5\sqrt{5}}{10}$
58. $\bullet \sin(2\theta) = -\frac{4}{5}$ $\bullet \cos(2\theta) = -\frac{3}{5}$ $\bullet \tan(2\theta) = \frac{4}{3}$
 $\bullet \sin\left(\frac{\theta}{2}\right) = \frac{\sqrt{50 + 10\sqrt{5}}}{10}$ $\bullet \cos\left(\frac{\theta}{2}\right) = \frac{\sqrt{50 - 10\sqrt{5}}}{10}$ $\bullet \tan\left(\frac{\theta}{2}\right) = \sqrt{\frac{5 + \sqrt{5}}{5 - \sqrt{5}}}$
 $\tan\left(\frac{\theta}{2}\right) = \frac{5 + 5\sqrt{5}}{10}$
74. $\frac{\cos(2\theta) + \cos(8\theta)}{2}$ 75. $\frac{\cos(5\theta) - \cos(9\theta)}{2}$ 76. $\frac{\sin(8\theta) + \sin(10\theta)}{2}$
77. $\frac{\cos(4\theta) + \cos(8\theta)}{2}$ 78. $\frac{\cos(\theta) - \cos(5\theta)}{2}$ 79. $\frac{\sin(2\theta) + \sin(4\theta)}{2}$
80. $2 \cos(4\theta) \cos(\theta)$ 81. $-2 \cos\left(\frac{9}{2}\theta\right) \sin\left(\frac{5}{2}\theta\right)$ 82. $2 \sin\left(\frac{11}{2}\theta\right) \sin\left(\frac{1}{2}\theta\right)$
83. $2 \cos(4\theta) \sin(5\theta)$ 84. $\sqrt{2} \cos\left(\theta - \frac{\pi}{4}\right)$ 85. $-\sqrt{2} \sin\left(\theta - \frac{\pi}{4}\right)$
90. $1 - \frac{x^2}{2}$ 91. $\frac{14x}{x^2 + 49}$ 92. $\ln|x + \sqrt{x^2 + 16}| - \ln(4)$

8.5 GRAPHS OF THE TRIGONOMETRIC FUNCTIONS

In this section, we return to our discussion of the circular (trigonometric) functions as functions of real numbers and pick up where we left off in Sections 8.2.1 and 8.3.1. As usual, we begin our study with the functions $f(t) = \cos(t)$ and $g(t) = \sin(t)$.

8.5.1 GRAPHS OF THE COSINE AND SINE FUNCTIONS

From Theorem 8.5 in Section 8.2.1, we know that the domain of $f(t) = \cos(t)$ and of $g(t) = \sin(t)$ is all real numbers, $(-\infty, \infty)$, and the range of both functions is $[-1, 1]$. The Even / Odd Identities in Theorem 8.12 tell us $\cos(-t) = \cos(t)$ for all real numbers t and $\sin(-t) = -\sin(t)$ for all real numbers t . This means $f(t) = \cos(t)$ is an even function, while $g(t) = \sin(t)$ is an odd function.¹ Another important property of these functions is that for coterminal angles α and β , $\cos(\alpha) = \cos(\beta)$ and $\sin(\alpha) = \sin(\beta)$. Said differently, $\cos(t + 2\pi k) = \cos(t)$ and $\sin(t + 2\pi k) = \sin(t)$ for all real numbers t and any integer k . This last property is given a special name.

Definition 8.3. Periodic Functions: A function f is said to be **periodic** if there is a real number c so that $f(t + c) = f(t)$ for all real numbers t in the domain of f . The smallest positive number p for which $f(t + p) = f(t)$ for all real numbers t in the domain of f , if it exists, is called the **period** of f .

We have already seen a family of periodic functions in Section 2.1: the constant functions. However, despite being periodic a constant function has no period. (We'll leave that odd gem as an exercise for you.) Returning to the circular functions, we see that by Definition 8.3, $f(t) = \cos(t)$ is periodic, since $\cos(t + 2\pi k) = \cos(t)$ for any integer k . To determine the period of f , we need to find the smallest real number p so that $f(t + p) = f(t)$ for all real numbers t or, said differently, the smallest positive real number p such that $\cos(t + p) = \cos(t)$ for all real numbers t . We know that $\cos(t + 2\pi) = \cos(t)$ for all real numbers t but the question remains if any smaller real number will do the trick. Suppose $p > 0$ and $\cos(t + p) = \cos(t)$ for all real numbers t . Then, in particular, $\cos(0 + p) = \cos(0)$ so that $\cos(p) = 1$. From this we know p is a multiple of 2π and, since the smallest positive multiple of 2π is 2π itself, we have the result. Similarly, we can show $g(t) = \sin(t)$ is also periodic with 2π as its period.² Having period 2π essentially means that we can completely understand everything about the functions $f(t) = \cos(t)$ and $g(t) = \sin(t)$ by studying one interval of length 2π , say $[0, 2\pi]$.³

One last property of the functions $f(t) = \cos(t)$ and $g(t) = \sin(t)$ is worth pointing out: both of these functions are continuous and smooth. Recall from Section 3.1 that geometrically this means the graphs of the cosine and sine functions have no jumps, gaps, holes in the graph, asymptotes,

¹See section 1.6 for a review of these concepts.

²Alternatively, we can use the Cofunction Identities in Theorem 8.14 to show that $g(t) = \sin(t)$ is periodic with period 2π since $g(t) = \sin(t) = \cos(\frac{\pi}{2} - t) = f(\frac{\pi}{2} - t)$.

³Technically, we should study the interval $[0, 2\pi)$,⁴ since whatever happens at $t = 2\pi$ is the same as what happens at $t = 0$. As we will see shortly, $t = 2\pi$ gives us an extra 'check' when we go to graph these functions.

⁴In some advanced texts, the interval of choice is $[-\pi, \pi)$.

corners or cusps. As we shall see, the graphs of both $f(t) = \cos(t)$ and $g(t) = \sin(t)$ meander nicely and don't cause any trouble. We summarize these facts in the following theorem.

Theorem 8.22. Properties of the Cosine and Sine Functions

- | | |
|----------------------------------|----------------------------------|
| • The function $f(x) = \cos(x)$ | • The function $g(x) = \sin(x)$ |
| – has domain $(-\infty, \infty)$ | – has domain $(-\infty, \infty)$ |
| – has range $[-1, 1]$ | – has range $[-1, 1]$ |
| – is continuous and smooth | – is continuous and smooth |
| – is even | – is odd |
| – has period 2π | – has period 2π |

In the chart above, we followed the convention established in Section 1.6 and used x as the independent variable and y as the dependent variable.⁵ This allows us to turn our attention to graphing the cosine and sine functions in the Cartesian Plane. To graph $y = \cos(x)$, we make a table as we did in Section 1.6 using some of the ‘common values’ of x in the interval $[0, 2\pi]$. This generates a *portion* of the cosine graph, which we call the ‘**fundamental cycle**’ of $y = \cos(x)$.

x	$\cos(x)$	$(x, \cos(x))$
0	1	$(0, 1)$
$\frac{\pi}{4}$	$\frac{\sqrt{2}}{2}$	$(\frac{\pi}{4}, \frac{\sqrt{2}}{2})$
$\frac{\pi}{2}$	0	$(\frac{\pi}{2}, 0)$
$\frac{3\pi}{4}$	$-\frac{\sqrt{2}}{2}$	$(\frac{3\pi}{4}, -\frac{\sqrt{2}}{2})$
π	-1	$(\pi, -1)$
$\frac{5\pi}{4}$	$-\frac{\sqrt{2}}{2}$	$(\frac{5\pi}{4}, -\frac{\sqrt{2}}{2})$
$\frac{3\pi}{2}$	0	$(\frac{3\pi}{2}, 0)$
$\frac{7\pi}{4}$	$\frac{\sqrt{2}}{2}$	$(\frac{7\pi}{4}, \frac{\sqrt{2}}{2})$
2π	1	$(2\pi, 1)$

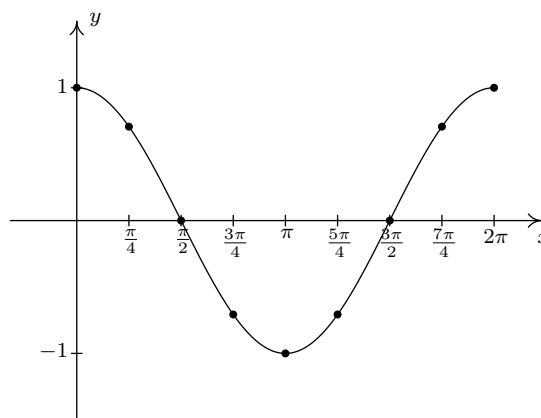

The ‘fundamental cycle’ of $y = \cos(x)$.

A few things about the graph above are worth mentioning. First, this graph represents only part of the graph of $y = \cos(x)$. To get the entire graph, we imagine ‘copying and pasting’ this graph end to end infinitely in both directions (left and right) on the x -axis. Secondly, the vertical scale here has been greatly exaggerated for clarity and aesthetics. Below is an accurate-to-scale graph of $y = \cos(x)$ showing several cycles with the ‘fundamental cycle’ plotted thicker than the others. The

⁵The use of x and y in this context is not to be confused with the x - and y -coordinates of points on the Unit Circle which define cosine and sine. Using the term ‘trigonometric function’ as opposed to ‘circular function’ can help with that, but one could then ask, “Hey, where’s the triangle?”

graph of $y = \cos(x)$ is usually described as ‘wavelike’ – indeed, many of the applications involving the cosine and sine functions feature modeling wavelike phenomena.

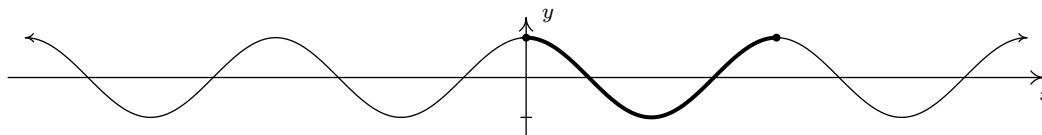

An accurately scaled graph of $y = \cos(x)$.

We can plot the fundamental cycle of the graph of $y = \sin(x)$ similarly, with similar results.

x	$\sin(x)$	$(x, \sin(x))$
0	0	$(0, 0)$
$\frac{\pi}{4}$	$\frac{\sqrt{2}}{2}$	$(\frac{\pi}{4}, \frac{\sqrt{2}}{2})$
$\frac{\pi}{2}$	1	$(\frac{\pi}{2}, 1)$
$\frac{3\pi}{4}$	$\frac{\sqrt{2}}{2}$	$(\frac{3\pi}{4}, \frac{\sqrt{2}}{2})$
π	0	$(\pi, 0)$
$\frac{5\pi}{4}$	$-\frac{\sqrt{2}}{2}$	$(\frac{5\pi}{4}, -\frac{\sqrt{2}}{2})$
$\frac{3\pi}{2}$	-1	$(\frac{3\pi}{2}, -1)$
$\frac{7\pi}{4}$	$-\frac{\sqrt{2}}{2}$	$(\frac{7\pi}{4}, -\frac{\sqrt{2}}{2})$
2π	0	$(2\pi, 0)$

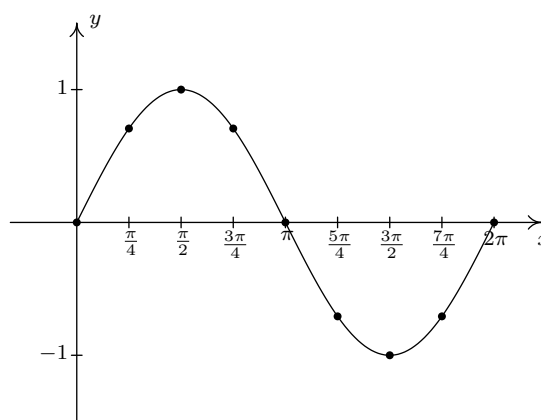

The ‘fundamental cycle’ of $y = \sin(x)$.

As with the graph of $y = \cos(x)$, we provide an accurately scaled graph of $y = \sin(x)$ below with the fundamental cycle highlighted.

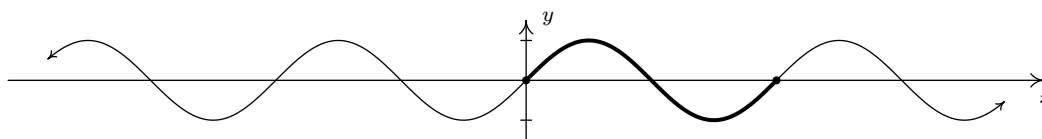

An accurately scaled graph of $y = \sin(x)$.

It is no accident that the graphs of $y = \cos(x)$ and $y = \sin(x)$ are so similar. Using a cofunction identity along with the even property of cosine, we have

$$\sin(x) = \cos\left(\frac{\pi}{2} - x\right) = \cos\left(-\left(x - \frac{\pi}{2}\right)\right) = \cos\left(x - \frac{\pi}{2}\right)$$

Recalling Section 1.7, we see from this formula that the graph of $y = \sin(x)$ is the result of shifting the graph of $y = \cos(x)$ to the right $\frac{\pi}{2}$ units. A visual inspection confirms this.

Now that we know the basic shapes of the graphs of $y = \cos(x)$ and $y = \sin(x)$, we can use Theorem 1.7 in Section 1.7 to graph more complicated curves. To do so, we need to keep track of

the movement of some key points on the original graphs. We choose to track the values $x = 0, \frac{\pi}{2}, \pi, \frac{3\pi}{2}$ and 2π . These ‘quarter marks’ correspond to quadrantal angles, and as such, mark the location of the zeros and the local extrema of these functions over exactly one period. Before we begin our next example, we need to review the concept of the ‘argument’ of a function as first introduced in Section 1.4. For the function $f(x) = 1 - 5 \cos(2x - \pi)$, the argument of f is x . We shall have occasion, however, to refer to the argument of the *cosine*, which in this case is $2x - \pi$. Loosely stated, the argument of a trigonometric function is the expression ‘inside’ the function.

Example 8.5.1. Graph one cycle of the following functions. State the period of each.

1. $f(x) = 3 \cos\left(\frac{\pi x - \pi}{2}\right) + 1$

2. $g(x) = \frac{1}{2} \sin(\pi - 2x) + \frac{3}{2}$

Solution.

1. We set the argument of the cosine, $\frac{\pi x - \pi}{2}$, equal to each of the values: $0, \frac{\pi}{2}, \pi, \frac{3\pi}{2}, 2\pi$ and solve for x . We summarize the results below.

a	$\frac{\pi x - \pi}{2} = a$	x
0	$\frac{\pi x - \pi}{2} = 0$	1
$\frac{\pi}{2}$	$\frac{\pi x - \pi}{2} = \frac{\pi}{2}$	2
π	$\frac{\pi x - \pi}{2} = \pi$	3
$\frac{3\pi}{2}$	$\frac{\pi x - \pi}{2} = \frac{3\pi}{2}$	4
2π	$\frac{\pi x - \pi}{2} = 2\pi$	5

Next, we substitute each of these x values into $f(x) = 3 \cos\left(\frac{\pi x - \pi}{2}\right) + 1$ to determine the corresponding y -values and connect the dots in a pleasing wavelike fashion.

x	$f(x)$	$(x, f(x))$
1	4	(1, 4)
2	1	(2, 1)
3	-2	(3, -2)
4	1	(4, 1)
5	4	(5, 4)

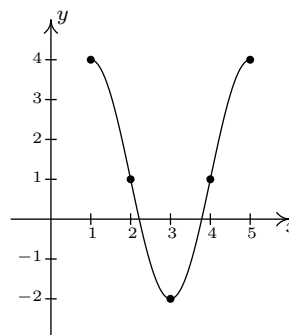

One cycle of $y = f(x)$.

One cycle is graphed on $[1, 5]$ so the period is the length of that interval which is 4.

2. Proceeding as above, we set the argument of the sine, $\pi - 2x$, equal to each of our quarter marks and solve for x .

a	$\pi - 2x = a$	x
0	$\pi - 2x = 0$	$\frac{\pi}{2}$
$\frac{\pi}{2}$	$\pi - 2x = \frac{\pi}{2}$	$\frac{\pi}{4}$
π	$\pi - 2x = \pi$	0
$\frac{3\pi}{2}$	$\pi - 2x = \frac{3\pi}{2}$	$-\frac{\pi}{4}$
2π	$\pi - 2x = 2\pi$	$-\frac{\pi}{2}$

We now find the corresponding y -values on the graph by substituting each of these x -values into $g(x) = \frac{1}{2} \sin(\pi - 2x) + \frac{3}{2}$. Once again, we connect the dots in a wavelike fashion.

x	$g(x)$	$(x, g(x))$
$\frac{\pi}{2}$	$\frac{3}{2}$	$(\frac{\pi}{2}, \frac{3}{2})$
$\frac{\pi}{4}$	2	$(\frac{\pi}{4}, 2)$
0	$\frac{3}{2}$	$(0, \frac{3}{2})$
$-\frac{\pi}{4}$	1	$(-\frac{\pi}{4}, 1)$
$-\frac{\pi}{2}$	$\frac{3}{2}$	$(-\frac{\pi}{2}, \frac{3}{2})$

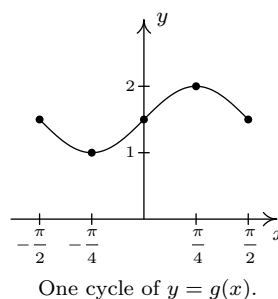

One cycle was graphed on the interval $[-\frac{\pi}{2}, \frac{\pi}{2}]$ so the period is $\frac{\pi}{2} - (-\frac{\pi}{2}) = \pi$. □

The functions in Example 8.5.1 are examples of **sinusoids**. Roughly speaking, a sinusoid is the result of taking the basic graph of $f(x) = \cos(x)$ or $g(x) = \sin(x)$ and performing any of the transformations⁶ mentioned in Section 1.7. Sinusoids can be characterized by four properties: period, amplitude, phase shift and vertical shift. We have already discussed period, that is, how long it takes for the sinusoid to complete one cycle. The standard period of both $f(x) = \cos(x)$ and $g(x) = \sin(x)$ is 2π , but horizontal scalings will change the period of the resulting sinusoid. The **amplitude** of the sinusoid is a measure of how ‘tall’ the wave is, as indicated in the figure below. The amplitude of the standard cosine and sine functions is 1, but vertical scalings can alter this.

⁶We have already seen how the Even/Odd and Cofunction Identities can be used to rewrite $g(x) = \sin(x)$ as a transformed version of $f(x) = \cos(x)$, so of course, the reverse is true: $f(x) = \cos(x)$ can be written as a transformed version of $g(x) = \sin(x)$. The authors have seen some instances where sinusoids are always converted to cosine functions while in other disciplines, the sinusoids are always written in terms of sine functions. We will discuss the applications of sinusoids in greater detail in Chapter 9. Until then, we will keep our options open.

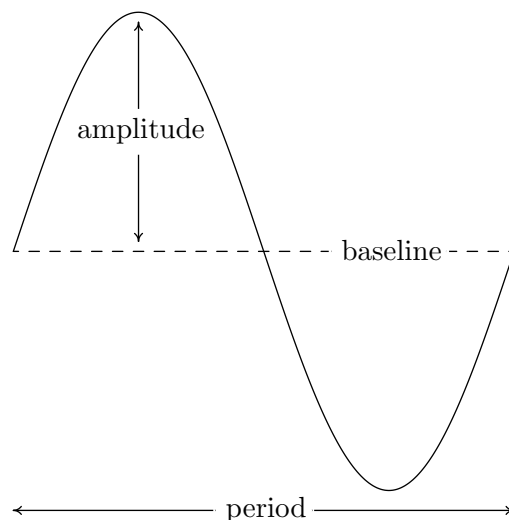

The **phase shift** of the sinusoid is the horizontal shift experienced by the fundamental cycle. We have seen that a phase (horizontal) shift of $\frac{\pi}{2}$ to the right takes $f(x) = \cos(x)$ to $g(x) = \sin(x)$ since $\cos(x - \frac{\pi}{2}) = \sin(x)$. As the reader can verify, a phase shift of $\frac{\pi}{2}$ to the left takes $g(x) = \sin(x)$ to $f(x) = \cos(x)$. The vertical shift of a sinusoid is exactly the same as the vertical shifts in Section 1.7. In most contexts, the vertical shift of a sinusoid is assumed to be 0, but we state the more general case below. The following theorem, which is reminiscent of Theorem 1.7 in Section 1.7, shows how to find these four fundamental quantities from the formula of the given sinusoid.

Theorem 8.23. For $\omega > 0$, the functions

$$C(x) = A \cos(\omega x + \phi) + B \quad \text{and} \quad S(x) = A \sin(\omega x + \phi) + B$$

- have period $\frac{2\pi}{\omega}$
- have amplitude $|A|$
- have phase shift $-\frac{\phi}{\omega}$
- have vertical shift B

We note that in some scientific and engineering circles, the quantity ϕ mentioned in Theorem 8.23 is called the **phase** of the sinusoid. Since our interest in this book is primarily with *graphing* sinusoids, we focus our attention on the horizontal shift $-\frac{\phi}{\omega}$ induced by ϕ .

The proof of Theorem 8.23 is a direct application of Theorem 1.7 in Section 1.7 and is left to the reader. The parameter ω , which is stipulated to be positive, is called the (**angular**) **frequency** of the sinusoid and is the number of cycles the sinusoid completes over a 2π interval. We can always ensure $\omega > 0$ using the Even/Odd Identities.⁷ We now test out Theorem 8.23 using the functions f and g featured in Example 8.5.1. First, we write $f(x)$ in the form prescribed in Theorem 8.23,

$$f(x) = 3 \cos\left(\frac{\pi x - \pi}{2}\right) + 1 = 3 \cos\left(\frac{\pi}{2}x + \left(-\frac{\pi}{2}\right)\right) + 1,$$

⁷Try using the formulas in Theorem 8.23 applied to $C(x) = \cos(-x + \pi)$ to see why we need $\omega > 0$.

so that $A = 3$, $\omega = \frac{\pi}{2}$, $\phi = -\frac{\pi}{2}$ and $B = 1$. According to Theorem 8.23, the period of f is $\frac{2\pi}{\omega} = \frac{2\pi}{\pi/2} = 4$, the amplitude is $|A| = |3| = 3$, the phase shift is $-\frac{\phi}{\omega} = -\frac{-\pi/2}{\pi/2} = 1$ (indicating a shift to the *right* 1 unit) and the vertical shift is $B = 1$ (indicating a shift *up* 1 unit.) All of these match with our graph of $y = f(x)$. Moreover, if we start with the basic shape of the cosine graph, shift it 1 unit to the right, 1 unit up, stretch the amplitude to 3 and shrink the period to 4, we will have reconstructed one period of the graph of $y = f(x)$. In other words, instead of tracking the five ‘quarter marks’ through the transformations to plot $y = f(x)$, we can use five other pieces of information: the phase shift, vertical shift, amplitude, period and basic shape of the cosine curve. Turning our attention now to the function g in Example 8.5.1, we first need to use the odd property of the sine function to write it in the form required by Theorem 8.23

$$g(x) = \frac{1}{2} \sin(\pi - 2x) + \frac{3}{2} = \frac{1}{2} \sin(-(2x - \pi)) + \frac{3}{2} = -\frac{1}{2} \sin(2x - \pi) + \frac{3}{2} = -\frac{1}{2} \sin(2x + (-\pi)) + \frac{3}{2}$$

We find $A = -\frac{1}{2}$, $\omega = 2$, $\phi = -\pi$ and $B = \frac{3}{2}$. The period is then $\frac{2\pi}{\omega} = \pi$, the amplitude is $|-\frac{1}{2}| = \frac{1}{2}$, the phase shift is $-\frac{-\pi}{2} = \frac{\pi}{2}$ (indicating a shift *right* $\frac{\pi}{2}$ units) and the vertical shift is *up* $\frac{3}{2}$. Note that, in this case, all of the data match our graph of $y = g(x)$ with the exception of the phase shift. Instead of the graph *starting* at $x = \frac{\pi}{2}$, it ends there. Remember, however, that the graph presented in Example 8.5.1 is only one portion of the graph of $y = g(x)$. Indeed, another complete cycle begins at $x = \frac{\pi}{2}$, and this is the cycle Theorem 8.23 is detecting. The reason for the discrepancy is that, in order to apply Theorem 8.23, we had to rewrite the formula for $g(x)$ using the odd property of the sine function. Note that whether we graph $y = g(x)$ using the ‘quarter marks’ approach or using the Theorem 8.23, we get one complete cycle of the graph, which means we have completely determined the sinusoid.

Example 8.5.2. Below is the graph of one complete cycle of a sinusoid $y = f(x)$.

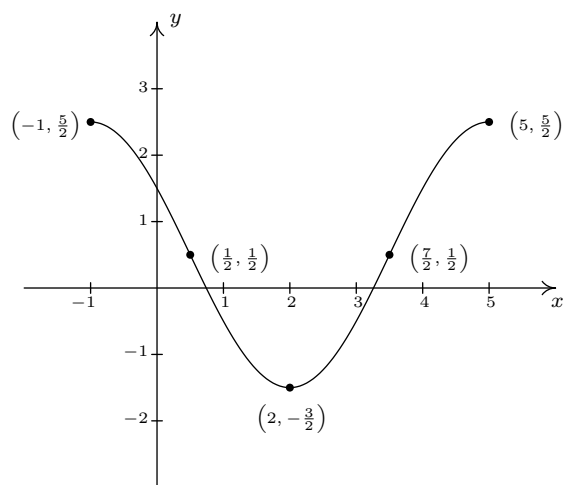

One cycle of $y = f(x)$.

1. Find a cosine function whose graph matches the graph of $y = f(x)$.

2. Find a sine function whose graph matches the graph of $y = f(x)$.

Solution.

1. We fit the data to a function of the form $C(x) = A \cos(\omega x + \phi) + B$. Since one cycle is graphed over the interval $[-1, 5]$, its period is $5 - (-1) = 6$. According to Theorem 8.23, $6 = \frac{2\pi}{\omega}$, so that $\omega = \frac{\pi}{3}$. Next, we see that the phase shift is -1 , so we have $-\frac{\phi}{\omega} = -1$, or $\phi = \omega = \frac{\pi}{3}$. To find the amplitude, note that the range of the sinusoid is $[-\frac{3}{2}, \frac{5}{2}]$. As a result, the amplitude $A = \frac{1}{2} [\frac{5}{2} - (-\frac{3}{2})] = \frac{1}{2}(4) = 2$. Finally, to determine the vertical shift, we average the endpoints of the range to find $B = \frac{1}{2} [\frac{5}{2} + (-\frac{3}{2})] = \frac{1}{2}(1) = \frac{1}{2}$. Our final answer is $C(x) = 2 \cos(\frac{\pi}{3}x + \frac{\pi}{3}) + \frac{1}{2}$.
2. Most of the work to fit the data to a function of the form $S(x) = A \sin(\omega x + \phi) + B$ is done. The period, amplitude and vertical shift are the same as before with $\omega = \frac{\pi}{3}$, $A = 2$ and $B = \frac{1}{2}$. The trickier part is finding the phase shift. To that end, we imagine extending the graph of the given sinusoid as in the figure below so that we can identify a cycle beginning at $(\frac{7}{2}, \frac{1}{2})$. Taking the phase shift to be $\frac{7}{2}$, we get $-\frac{\phi}{\omega} = \frac{7}{2}$, or $\phi = -\frac{7}{2}\omega = -\frac{7}{2}(\frac{\pi}{3}) = -\frac{7\pi}{6}$. Hence, our answer is $S(x) = 2 \sin(\frac{\pi}{3}x - \frac{7\pi}{6}) + \frac{1}{2}$.

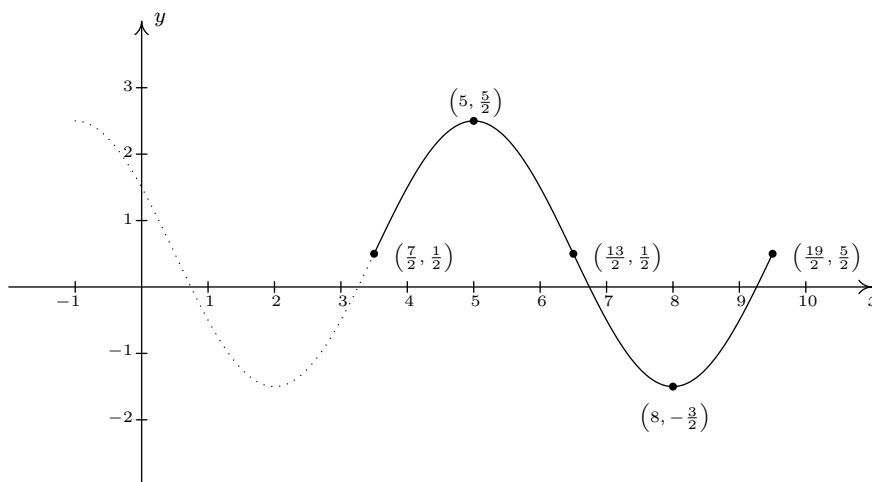

Extending the graph of $y = f(x)$.

□

Note that each of the answers given in Example 8.5.2 is one choice out of many possible answers. For example, when fitting a sine function to the data, we could have chosen to start at $(\frac{1}{2}, \frac{1}{2})$ taking $A = -2$. In this case, the phase shift is $\frac{1}{2}$ so $\phi = -\frac{\pi}{6}$ for an answer of $S(x) = -2 \sin(\frac{\pi}{3}x - \frac{\pi}{6}) + \frac{1}{2}$. Alternatively, we could have extended the graph of $y = f(x)$ to the left and considered a sine function starting at $(-\frac{5}{2}, \frac{1}{2})$, and so on. Each of these formulas determine the same sinusoid curve and their formulas are all equivalent using identities. Speaking of identities, if we use the sum identity for cosine, we can expand the formula to yield

$$C(x) = A \cos(\omega x + \phi) + B = A \cos(\omega x) \cos(\phi) - A \sin(\omega x) \sin(\phi) + B.$$

Similarly, using the sum identity for sine, we get

$$S(x) = A \sin(\omega x + \phi) + B = A \sin(\omega x) \cos(\phi) + A \cos(\omega x) \sin(\phi) + B.$$

Making these observations allows us to recognize (and graph) functions as sinusoids which, at first glance, don't appear to fit the forms of either $C(x)$ or $S(x)$.

Example 8.5.3. Consider the function $f(x) = \cos(2x) - \sqrt{3} \sin(2x)$. Find a formula for $f(x)$:

1. in the form $C(x) = A \cos(\omega x + \phi) + B$ for $\omega > 0$
2. in the form $S(x) = A \sin(\omega x + \phi) + B$ for $\omega > 0$

Check your answers analytically using identities and graphically using a calculator.

Solution.

1. The key to this problem is to use the expanded forms of the sinusoid formulas and match up corresponding coefficients. Equating $f(x) = \cos(2x) - \sqrt{3} \sin(2x)$ with the expanded form of $C(x) = A \cos(\omega x + \phi) + B$, we get

$$\cos(2x) - \sqrt{3} \sin(2x) = A \cos(\omega x) \cos(\phi) - A \sin(\omega x) \sin(\phi) + B$$

It should be clear that we can take $\omega = 2$ and $B = 0$ to get

$$\cos(2x) - \sqrt{3} \sin(2x) = A \cos(2x) \cos(\phi) - A \sin(2x) \sin(\phi)$$

To determine A and ϕ , a bit more work is involved. We get started by equating the coefficients of the trigonometric functions on either side of the equation. On the left hand side, the coefficient of $\cos(2x)$ is 1, while on the right hand side, it is $A \cos(\phi)$. Since this equation is to hold for all real numbers, we must have that $A \cos(\phi) = 1$. Similarly, we find by equating the coefficients of $\sin(2x)$ that $A \sin(\phi) = \sqrt{3}$. What we have here is a system of nonlinear equations! We can temporarily eliminate the dependence on ϕ by using the Pythagorean Identity. We know $\cos^2(\phi) + \sin^2(\phi) = 1$, so multiplying this by A^2 gives $A^2 \cos^2(\phi) + A^2 \sin^2(\phi) = A^2$. Since $A \cos(\phi) = 1$ and $A \sin(\phi) = \sqrt{3}$, we get $A^2 = 1^2 + (\sqrt{3})^2 = 4$ or $A = \pm 2$. Choosing $A = 2$, we have $2 \cos(\phi) = 1$ and $2 \sin(\phi) = \sqrt{3}$ or, after some rearrangement, $\cos(\phi) = \frac{1}{2}$ and $\sin(\phi) = \frac{\sqrt{3}}{2}$. One such angle ϕ which satisfies this criteria is $\phi = \frac{\pi}{3}$. Hence, one way to write $f(x)$ as a sinusoid is $f(x) = 2 \cos(2x + \frac{\pi}{3})$. We can easily check our answer using the sum formula for cosine

$$\begin{aligned} f(x) &= 2 \cos\left(2x + \frac{\pi}{3}\right) \\ &= 2 \left[\cos(2x) \cos\left(\frac{\pi}{3}\right) - \sin(2x) \sin\left(\frac{\pi}{3}\right) \right] \\ &= 2 \left[\cos(2x) \left(\frac{1}{2}\right) - \sin(2x) \left(\frac{\sqrt{3}}{2}\right) \right] \\ &= \cos(2x) - \sqrt{3} \sin(2x) \end{aligned}$$

2. Proceeding as before, we equate $f(x) = \cos(2x) - \sqrt{3}\sin(2x)$ with the expanded form of $S(x) = A \sin(\omega x + \phi) + B$ to get

$$\cos(2x) - \sqrt{3}\sin(2x) = A \sin(\omega x) \cos(\phi) + A \cos(\omega x) \sin(\phi) + B$$

Once again, we may take $\omega = 2$ and $B = 0$ so that

$$\cos(2x) - \sqrt{3}\sin(2x) = A \sin(2x) \cos(\phi) + A \cos(2x) \sin(\phi)$$

We equate⁸ the coefficients of $\cos(2x)$ on either side and get $A \sin(\phi) = 1$ and $A \cos(\phi) = -\sqrt{3}$. Using $A^2 \cos^2(\phi) + A^2 \sin^2(\phi) = A^2$ as before, we get $A = \pm 2$, and again we choose $A = 2$. This means $2 \sin(\phi) = 1$, or $\sin(\phi) = \frac{1}{2}$, and $2 \cos(\phi) = -\sqrt{3}$, which means $\cos(\phi) = -\frac{\sqrt{3}}{2}$. One such angle which meets these criteria is $\phi = \frac{5\pi}{6}$. Hence, we have $f(x) = 2 \sin(2x + \frac{5\pi}{6})$. Checking our work analytically, we have

$$\begin{aligned} f(x) &= 2 \sin\left(2x + \frac{5\pi}{6}\right) \\ &= 2 \left[\sin(2x) \cos\left(\frac{5\pi}{6}\right) + \cos(2x) \sin\left(\frac{5\pi}{6}\right) \right] \\ &= 2 \left[\sin(2x) \left(-\frac{\sqrt{3}}{2}\right) + \cos(2x) \left(\frac{1}{2}\right) \right] \\ &= \cos(2x) - \sqrt{3}\sin(2x) \end{aligned}$$

Graphing the three formulas for $f(x)$ result in the identical curve, verifying our analytic work.

```

Plot1 Plot2 Plot3
\Y1=cos(2X)-√(3)
sin(2X)
\Y2=2cos(2X+π/3)
\Y3=2sin(2X+5π/6)
\Y4=

```

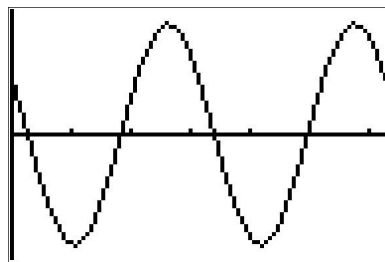

□

It is important to note that in order for the technique presented in Example 8.5.3 to fit a function into one of the forms in Theorem 8.23, the arguments of the cosine and sine function must match. That is, while $f(x) = \cos(2x) - \sqrt{3}\sin(2x)$ is a sinusoid, $g(x) = \cos(2x) - \sqrt{3}\sin(3x)$ is not.⁹ It is also worth mentioning that, had we chosen $A = -2$ instead of $A = 2$ as we worked through Example 8.5.3, our final answers would have *looked* different. The reader is encouraged to rework Example 8.5.3 using $A = -2$ to see what these differences are, and then for a challenging exercise, use identities to show that the formulas are all equivalent. The general equations to fit a function of the form $f(x) = a \cos(\omega x) + b \sin(\omega x) + B$ into one of the forms in Theorem 8.23 are explored in Exercise 35.

⁸Be careful here!

⁹This graph does, however, exhibit sinusoid-like characteristics! Check it out!

8.5.2 GRAPHS OF THE SECANT AND COSECANT FUNCTIONS

We now turn our attention to graphing $y = \sec(x)$. Since $\sec(x) = \frac{1}{\cos(x)}$, we can use our table of values for the graph of $y = \cos(x)$ and take reciprocals. We know from Section 8.3.1 that the domain of $F(x) = \sec(x)$ excludes all odd multiples of $\frac{\pi}{2}$, and sure enough, we run into trouble at $x = \frac{\pi}{2}$ and $x = \frac{3\pi}{2}$ since $\cos(x) = 0$ at these values. Using the notation introduced in Section 4.2, we have that as $x \rightarrow \frac{\pi}{2}^-$, $\cos(x) \rightarrow 0^+$, so $\sec(x) \rightarrow \infty$. (See Section 8.3.1 for a more detailed analysis.) Similarly, we find that as $x \rightarrow \frac{\pi}{2}^+$, $\sec(x) \rightarrow -\infty$; as $x \rightarrow \frac{3\pi}{2}^-$, $\sec(x) \rightarrow -\infty$; and as $x \rightarrow \frac{3\pi}{2}^+$, $\sec(x) \rightarrow \infty$. This means we have a pair of vertical asymptotes to the graph of $y = \sec(x)$, $x = \frac{\pi}{2}$ and $x = \frac{3\pi}{2}$. Since $\cos(x)$ is periodic with period 2π , it follows that $\sec(x)$ is also.¹⁰ Below we graph a fundamental cycle of $y = \sec(x)$ along with a more complete graph obtained by the usual ‘copying and pasting.’¹¹

x	$\cos(x)$	$\sec(x)$	$(x, \sec(x))$
0	1	1	(0, 1)
$\frac{\pi}{4}$	$\frac{\sqrt{2}}{2}$	$\sqrt{2}$	$(\frac{\pi}{4}, \sqrt{2})$
$\frac{\pi}{2}$	0	undefined	
$\frac{3\pi}{4}$	$-\frac{\sqrt{2}}{2}$	$-\sqrt{2}$	$(\frac{3\pi}{4}, -\sqrt{2})$
π	-1	-1	(π , -1)
$\frac{5\pi}{4}$	$-\frac{\sqrt{2}}{2}$	$-\sqrt{2}$	$(\frac{5\pi}{4}, -\sqrt{2})$
$\frac{3\pi}{2}$	0	undefined	
$\frac{7\pi}{4}$	$\frac{\sqrt{2}}{2}$	$\sqrt{2}$	$(\frac{7\pi}{4}, \sqrt{2})$
2π	1	1	(2π , 1)

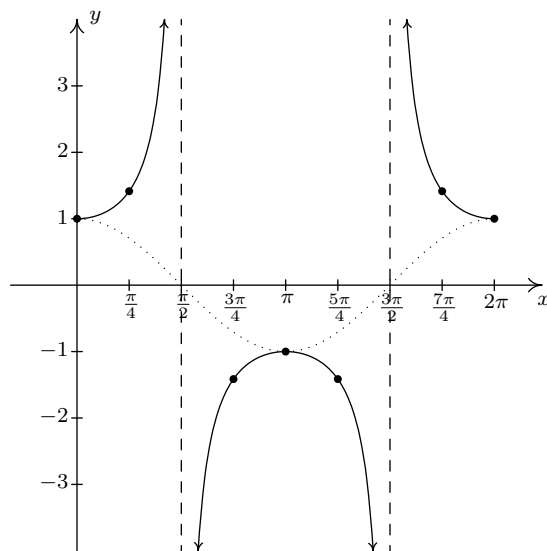
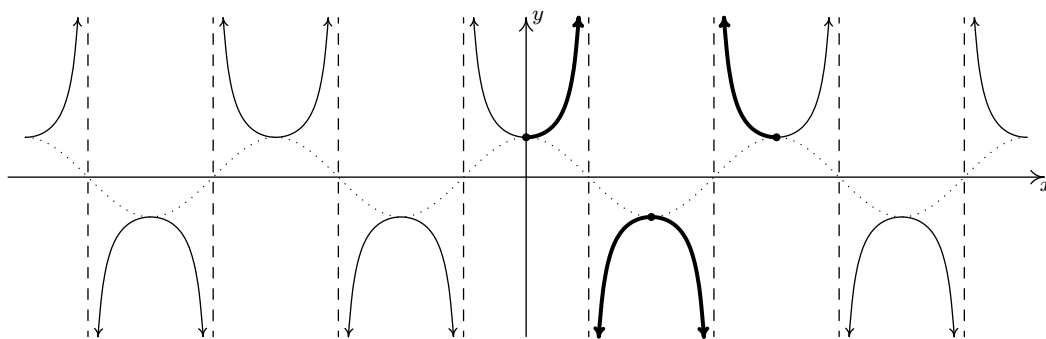
The ‘fundamental cycle’ of $y = \sec(x)$.The graph of $y = \sec(x)$.

¹⁰Provided $\sec(\alpha)$ and $\sec(\beta)$ are defined, $\sec(\alpha) = \sec(\beta)$ if and only if $\cos(\alpha) = \cos(\beta)$. Hence, $\sec(x)$ inherits its period from $\cos(x)$.

¹¹In Section 8.3.1, we argued the range of $F(x) = \sec(x)$ is $(-\infty, -1] \cup [1, \infty)$. We can now see this graphically.

As one would expect, to graph $y = \csc(x)$ we begin with $y = \sin(x)$ and take reciprocals of the corresponding y -values. Here, we encounter issues at $x = 0$, $x = \pi$ and $x = 2\pi$. Proceeding with the usual analysis, we graph the fundamental cycle of $y = \csc(x)$ below along with the dotted graph of $y = \sin(x)$ for reference. Since $y = \sin(x)$ and $y = \cos(x)$ are merely phase shifts of each other, so too are $y = \csc(x)$ and $y = \sec(x)$.

x	$\sin(x)$	$\csc(x)$	$(x, \csc(x))$
0	0	undefined	
$\frac{\pi}{4}$	$\frac{\sqrt{2}}{2}$	$\sqrt{2}$	$(\frac{\pi}{4}, \sqrt{2})$
$\frac{\pi}{2}$	1	1	$(\frac{\pi}{2}, 1)$
$\frac{3\pi}{4}$	$\frac{\sqrt{2}}{2}$	$\sqrt{2}$	$(\frac{3\pi}{4}, \sqrt{2})$
π	0	undefined	
$\frac{5\pi}{4}$	$-\frac{\sqrt{2}}{2}$	$-\sqrt{2}$	$(\frac{5\pi}{4}, -\sqrt{2})$
$\frac{3\pi}{2}$	-1	-1	$(\frac{3\pi}{2}, -1)$
$\frac{7\pi}{4}$	$-\frac{\sqrt{2}}{2}$	$-\sqrt{2}$	$(\frac{7\pi}{4}, -\sqrt{2})$
2π	0	undefined	

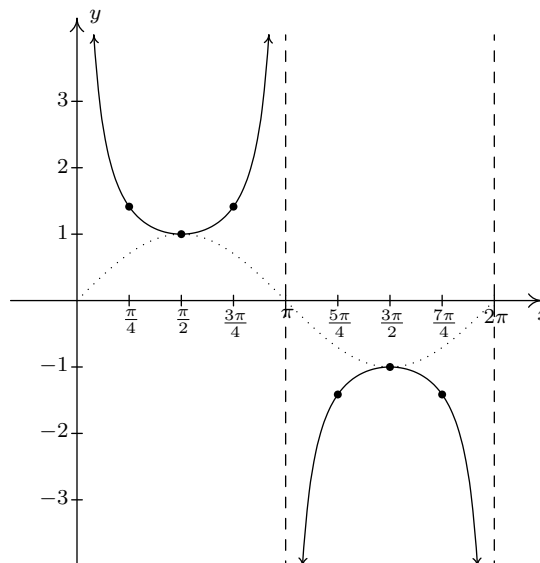

The 'fundamental cycle' of $y = \csc(x)$.

Once again, our domain and range work in Section 8.3.1 is verified geometrically in the graph of $y = G(x) = \csc(x)$.

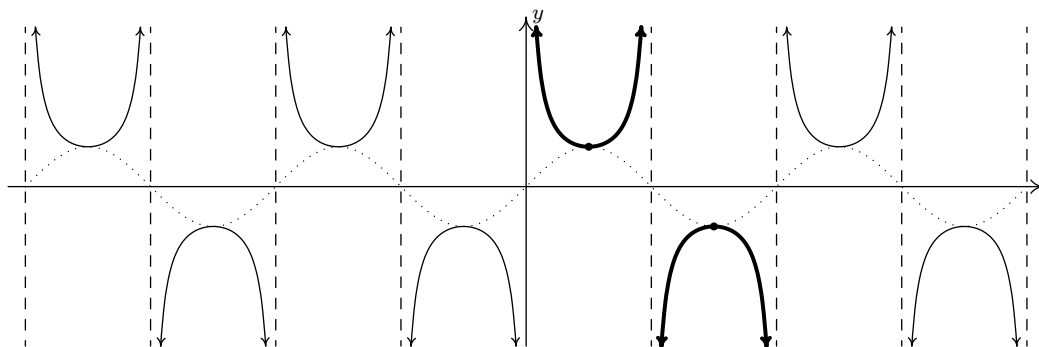

The graph of $y = \csc(x)$.

Note that, on the intervals between the vertical asymptotes, both $F(x) = \sec(x)$ and $G(x) = \csc(x)$ are continuous and smooth. In other words, they are continuous and smooth *on their domains*.¹² The following theorem summarizes the properties of the secant and cosecant functions. Note that

¹²Just like the rational functions in Chapter 4 are continuous and smooth on their domains because polynomials are continuous and smooth everywhere, the secant and cosecant functions are continuous and smooth on their domains since the cosine and sine functions are continuous and smooth everywhere.

all of these properties are direct results of them being reciprocals of the cosine and sine functions, respectively.

Theorem 8.24. Properties of the Secant and Cosecant Functions

- The function $F(x) = \sec(x)$

- has domain $\{x : x \neq \frac{\pi}{2} + \pi k, k \text{ is an integer}\} = \bigcup_{k=-\infty}^{\infty} \left(\frac{(2k+1)\pi}{2}, \frac{(2k+3)\pi}{2} \right)$

- has range $\{y : |y| \geq 1\} = (-\infty, -1] \cup [1, \infty)$

- is continuous and smooth on its domain

- is even

- has period 2π

- The function $G(x) = \csc(x)$

- has domain $\{x : x \neq \pi k, k \text{ is an integer}\} = \bigcup_{k=-\infty}^{\infty} (k\pi, (k+1)\pi)$

- has range $\{y : |y| \geq 1\} = (-\infty, -1] \cup [1, \infty)$

- is continuous and smooth on its domain

- is odd

- has period 2π

In the next example, we discuss graphing more general secant and cosecant curves.

Example 8.5.4. Graph one cycle of the following functions. State the period of each.

1. $f(x) = 1 - 2\sec(2x)$

2. $g(x) = \frac{\csc(\pi - \pi x) - 5}{3}$

Solution.

1. To graph $y = 1 - 2\sec(2x)$, we follow the same procedure as in Example 8.5.1. First, we set the argument of secant, $2x$, equal to the ‘quarter marks’ $0, \frac{\pi}{2}, \pi, \frac{3\pi}{2}$ and 2π and solve for x .

a	$2x = a$	x
0	$2x = 0$	0
$\frac{\pi}{2}$	$2x = \frac{\pi}{2}$	$\frac{\pi}{4}$
π	$2x = \pi$	$\frac{\pi}{2}$
$\frac{3\pi}{2}$	$2x = \frac{3\pi}{2}$	$\frac{3\pi}{4}$
2π	$2x = 2\pi$	π

Next, we substitute these x values into $f(x)$. If $f(x)$ exists, we have a point on the graph; otherwise, we have found a vertical asymptote. In addition to these points and asymptotes, we have graphed the associated cosine curve – in this case $y = 1 - 2 \cos(2x)$ – dotted in the picture below. Since one cycle is graphed over the interval $[0, \pi]$, the period is $\pi - 0 = \pi$.

x	$f(x)$	$(x, f(x))$
0	-1	$(0, -1)$
$\frac{\pi}{4}$	undefined	
$\frac{\pi}{2}$	3	$(\frac{\pi}{2}, 3)$
$\frac{3\pi}{4}$	undefined	
π	-1	$(\pi, -1)$

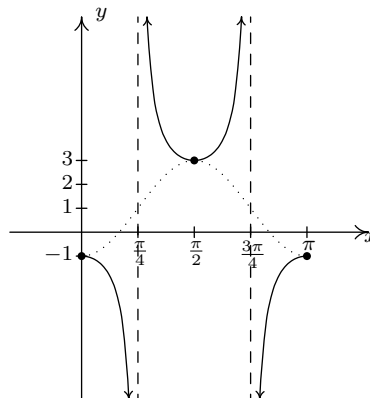

One cycle of $y = 1 - 2 \sec(2x)$.

2. Proceeding as before, we set the argument of cosecant in $g(x) = \frac{\csc(\pi - \pi x) - 5}{3}$ equal to the quarter marks and solve for x .

a	$\pi - \pi x = a$	x
0	$\pi - \pi x = 0$	1
$\frac{\pi}{2}$	$\pi - \pi x = \frac{\pi}{2}$	$\frac{1}{2}$
π	$\pi - \pi x = \pi$	0
$\frac{3\pi}{2}$	$\pi - \pi x = \frac{3\pi}{2}$	$-\frac{1}{2}$
2π	$\pi - \pi x = 2\pi$	-1

Substituting these x -values into $g(x)$, we generate the graph below and find the period to be $1 - (-1) = 2$. The associated sine curve, $y = \frac{\sin(\pi - \pi x) - 5}{3}$, is dotted in as a reference.

x	$g(x)$	$(x, g(x))$
1	undefined	
$\frac{1}{2}$	$-\frac{4}{3}$	$(\frac{1}{2}, -\frac{4}{3})$
0	undefined	
$-\frac{1}{2}$	-2	$(-\frac{1}{2}, -2)$
-1	undefined	

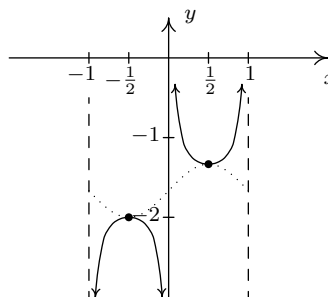

One cycle of $y = \frac{\csc(\pi - \pi x) - 5}{3}$.

□

Before moving on, we note that it is possible to speak of the period, phase shift and vertical shift of secant and cosecant graphs and use even/odd identities to put them in a form similar to the sinusoid forms mentioned in Theorem 8.23. Since these quantities match those of the corresponding cosine and sine curves, we do not spell this out explicitly. Finally, since the ranges of secant and cosecant are unbounded, there is no amplitude associated with these curves.

8.5.3 GRAPHS OF THE TANGENT AND COTANGENT FUNCTIONS

Finally, we turn our attention to the graphs of the tangent and cotangent functions. When constructing a table of values for the tangent function, we see that $J(x) = \tan(x)$ is undefined at $x = \frac{\pi}{2}$ and $x = \frac{3\pi}{2}$, in accordance with our findings in Section 8.3.1. As $x \rightarrow \frac{\pi}{2}^-$, $\sin(x) \rightarrow 1^-$ and $\cos(x) \rightarrow 0^+$, so that $\tan(x) = \frac{\sin(x)}{\cos(x)} \rightarrow \infty$ producing a vertical asymptote at $x = \frac{\pi}{2}$. Using a similar analysis, we get that as $x \rightarrow \frac{\pi}{2}^+$, $\tan(x) \rightarrow -\infty$; as $x \rightarrow \frac{3\pi}{2}^-$, $\tan(x) \rightarrow \infty$; and as $x \rightarrow \frac{3\pi}{2}^+$, $\tan(x) \rightarrow -\infty$. Plotting this information and performing the usual ‘copy and paste’ produces:

x	$\tan(x)$	$(x, \tan(x))$
0	0	$(0, 0)$
$\frac{\pi}{4}$	1	$(\frac{\pi}{4}, 1)$
$\frac{\pi}{2}$	undefined	
$\frac{3\pi}{4}$	-1	$(\frac{3\pi}{4}, -1)$
π	0	$(\pi, 0)$
$\frac{5\pi}{4}$	1	$(\frac{5\pi}{4}, 1)$
$\frac{3\pi}{2}$	undefined	
$\frac{7\pi}{4}$	-1	$(\frac{7\pi}{4}, -1)$
2π	0	$(2\pi, 0)$

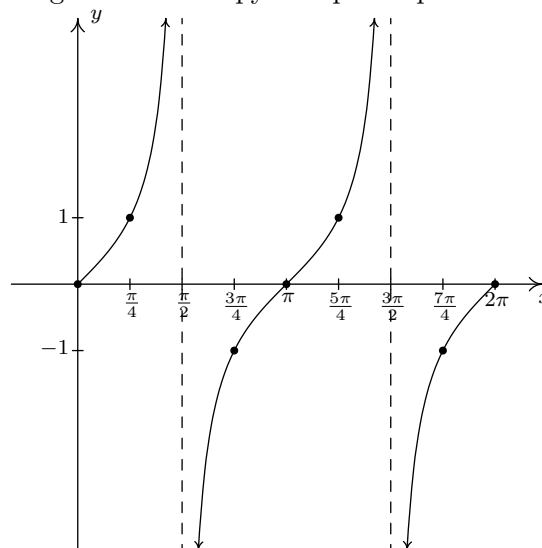

The graph of $y = \tan(x)$ over $[0, 2\pi]$.

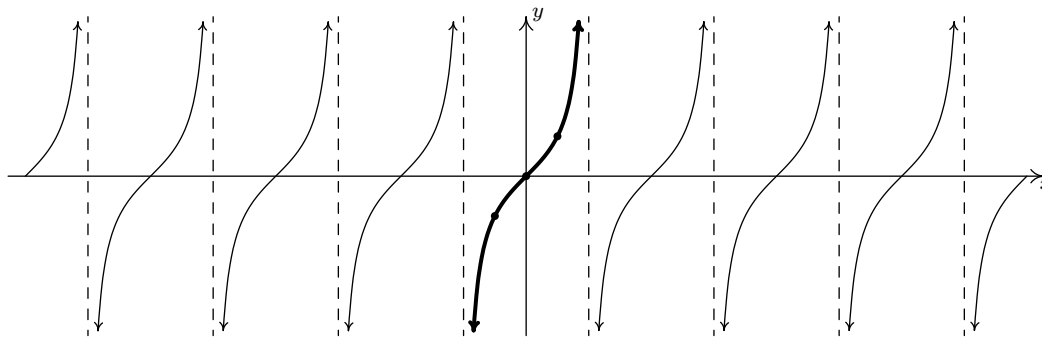

The graph of $y = \tan(x)$.

From the graph, it appears as if the tangent function is periodic with period π . To prove that this is the case, we appeal to the sum formula for tangents. We have:

$$\tan(x + \pi) = \frac{\tan(x) + \tan(\pi)}{1 - \tan(x)\tan(\pi)} = \frac{\tan(x) + 0}{1 - (\tan(x))(0)} = \tan(x),$$

which tells us the period of $\tan(x)$ is at most π . To show that it is exactly π , suppose p is a positive real number so that $\tan(x + p) = \tan(x)$ for all real numbers x . For $x = 0$, we have $\tan(p) = \tan(0 + p) = \tan(0) = 0$, which means p is a multiple of π . The smallest positive multiple of π is π itself, so we have established the result. We take as our fundamental cycle for $y = \tan(x)$ the interval $(-\frac{\pi}{2}, \frac{\pi}{2})$, and use as our ‘quarter marks’ $x = -\frac{\pi}{2}, -\frac{\pi}{4}, 0, \frac{\pi}{4}$ and $\frac{\pi}{2}$. From the graph, we see confirmation of our domain and range work in Section 8.3.1.

It should be no surprise that $K(x) = \cot(x)$ behaves similarly to $J(x) = \tan(x)$. Plotting $\cot(x)$ over the interval $[0, 2\pi]$ results in the graph below.

x	$\cot(x)$	$(x, \cot(x))$
0	undefined	
$\frac{\pi}{4}$	1	$(\frac{\pi}{4}, 1)$
$\frac{\pi}{2}$	0	$(\frac{\pi}{2}, 0)$
$\frac{3\pi}{4}$	-1	$(\frac{3\pi}{4}, -1)$
π	undefined	
$\frac{5\pi}{4}$	1	$(\frac{5\pi}{4}, 1)$
$\frac{3\pi}{2}$	0	$(\frac{3\pi}{2}, 0)$
$\frac{7\pi}{4}$	-1	$(\frac{7\pi}{4}, -1)$
2π	undefined	

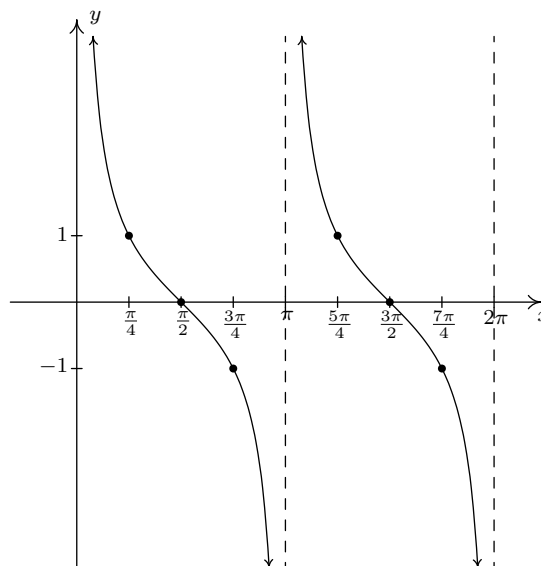

The graph of $y = \cot(x)$ over $[0, 2\pi]$.

From these data, it clearly appears as if the period of $\cot(x)$ is π , and we leave it to the reader to prove this.¹³ We take as one fundamental cycle the interval $(0, \pi)$ with quarter marks: $x = 0, \frac{\pi}{4}, \frac{\pi}{2}, \frac{3\pi}{4}$ and π . A more complete graph of $y = \cot(x)$ is below, along with the fundamental cycle highlighted as usual. Once again, we see the domain and range of $K(x) = \cot(x)$ as read from the graph matches with what we found analytically in Section 8.3.1.

¹³Certainly, mimicking the proof that the period of $\tan(x)$ is an option; for another approach, consider transforming $\tan(x)$ to $\cot(x)$ using identities.

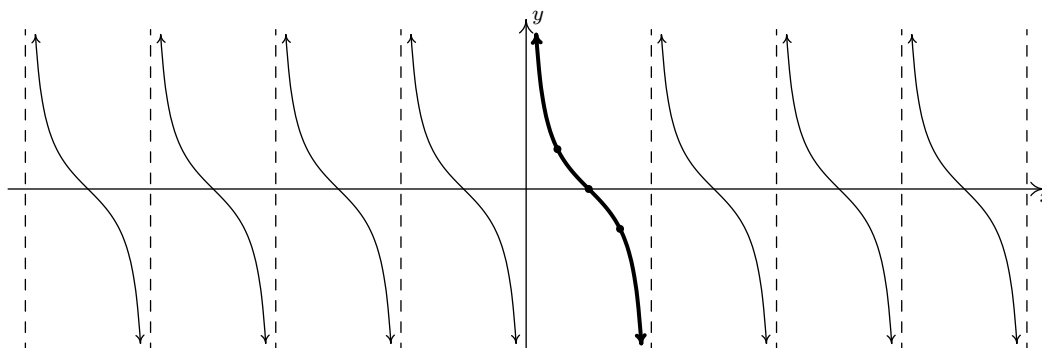
The graph of $y = \cot(x)$.

The properties of the tangent and cotangent functions are summarized below. As with Theorem 8.24, each of the results below can be traced back to properties of the cosine and sine functions and the definition of the tangent and cotangent functions as quotients thereof.

Theorem 8.25. Properties of the Tangent and Cotangent Functions

- The function $J(x) = \tan(x)$

- has domain $\{x : x \neq \frac{\pi}{2} + \pi k, k \text{ is an integer}\} = \bigcup_{k=-\infty}^{\infty} \left(\frac{(2k+1)\pi}{2}, \frac{(2k+3)\pi}{2} \right)$
- has range $(-\infty, \infty)$
- is continuous and smooth on its domain
- is odd
- has period π

- The function $K(x) = \cot(x)$

- has domain $\{x : x \neq \pi k, k \text{ is an integer}\} = \bigcup_{k=-\infty}^{\infty} (k\pi, (k+1)\pi)$
- has range $(-\infty, \infty)$
- is continuous and smooth on its domain
- is odd
- has period π

Example 8.5.5. Graph one cycle of the following functions. Find the period.

1. $f(x) = 1 - \tan\left(\frac{x}{2}\right)$.

2. $g(x) = 2 \cot\left(\frac{\pi}{2}x + \pi\right) + 1$.

Solution.

1. We proceed as we have in all of the previous graphing examples by setting the argument of tangent in $f(x) = 1 - \tan\left(\frac{x}{2}\right)$, namely $\frac{x}{2}$, equal to each of the ‘quarter marks’ $-\frac{\pi}{2}$, $-\frac{\pi}{4}$, 0 , $\frac{\pi}{4}$ and $\frac{\pi}{2}$, and solving for x .

a	$\frac{x}{2} = a$	x
$-\frac{\pi}{2}$	$\frac{x}{2} = -\frac{\pi}{2}$	$-\pi$
$-\frac{\pi}{4}$	$\frac{x}{2} = -\frac{\pi}{4}$	$-\frac{\pi}{2}$
0	$\frac{x}{2} = 0$	0
$\frac{\pi}{4}$	$\frac{x}{2} = \frac{\pi}{4}$	$\frac{\pi}{2}$
$\frac{\pi}{2}$	$\frac{x}{2} = \frac{\pi}{2}$	π

Substituting these x -values into $f(x)$, we find points on the graph and the vertical asymptotes.

x	$f(x)$	$(x, f(x))$
$-\pi$	undefined	
$-\frac{\pi}{2}$	2	$\left(-\frac{\pi}{2}, 2\right)$
0	1	$(0, 1)$
$\frac{\pi}{2}$	0	$\left(\frac{\pi}{2}, 0\right)$
π	undefined	

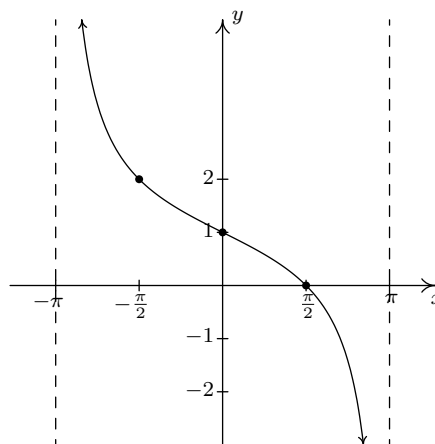

One cycle of $y = 1 - \tan\left(\frac{x}{2}\right)$.

We see that the period is $\pi - (-\pi) = 2\pi$.

2. The ‘quarter marks’ for the fundamental cycle of the cotangent curve are 0 , $\frac{\pi}{4}$, $\frac{\pi}{2}$, $\frac{3\pi}{4}$ and π . To graph $g(x) = 2 \cot\left(\frac{\pi}{2}x + \pi\right) + 1$, we begin by setting $\frac{\pi}{2}x + \pi$ equal to each quarter mark and solving for x .

a	$\frac{\pi}{2}x + \pi = a$	x
0	$\frac{\pi}{2}x + \pi = 0$	-2
$\frac{\pi}{4}$	$\frac{\pi}{2}x + \pi = \frac{\pi}{4}$	$-\frac{3}{2}$
$\frac{\pi}{2}$	$\frac{\pi}{2}x + \pi = \frac{\pi}{2}$	-1
$\frac{3\pi}{4}$	$\frac{\pi}{2}x + \pi = \frac{3\pi}{4}$	$-\frac{1}{2}$
π	$\frac{\pi}{2}x + \pi = \pi$	0

We now use these x -values to generate our graph.

x	$g(x)$	$(x, g(x))$
-2	undefined	
$-\frac{3}{2}$	3	$(-\frac{3}{2}, 3)$
-1	1	$(-1, 1)$
$-\frac{1}{2}$	-1	$(-\frac{1}{2}, -1)$
0	undefined	

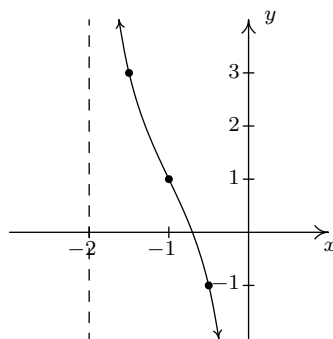

One cycle of $y = 2 \cot\left(\frac{\pi}{2}x + \pi\right) + 1$.

We find the period to be $0 - (-2) = 2$. □

As with the secant and cosecant functions, it is possible to extend the notion of period, phase shift and vertical shift to the tangent and cotangent functions as we did for the cosine and sine functions in Theorem 8.23. Since the number of classical applications involving sinusoids far outnumber those involving tangent and cotangent functions, we omit this. The ambitious reader is invited to formulate such a theorem, however.

8.5.4 EXERCISES

In Exercises 1 - 12, graph one cycle of the given function. State the period, amplitude, phase shift and vertical shift of the function.

1. $y = 3 \sin(x)$

2. $y = \sin(3x)$

3. $y = -2 \cos(x)$

4. $y = \cos\left(x - \frac{\pi}{2}\right)$

5. $y = -\sin\left(x + \frac{\pi}{3}\right)$

6. $y = \sin(2x - \pi)$

7. $y = -\frac{1}{3} \cos\left(\frac{1}{2}x + \frac{\pi}{3}\right)$

8. $y = \cos(3x - 2\pi) + 4$

9. $y = \sin\left(-x - \frac{\pi}{4}\right) - 2$

10. $y = \frac{2}{3} \cos\left(\frac{\pi}{2} - 4x\right) + 1$

11. $y = -\frac{3}{2} \cos\left(2x + \frac{\pi}{3}\right) - \frac{1}{2}$

12. $y = 4 \sin(-2\pi x + \pi)$

In Exercises 13 - 24, graph one cycle of the given function. State the period of the function.

13. $y = \tan\left(x - \frac{\pi}{3}\right)$

14. $y = 2 \tan\left(\frac{1}{4}x\right) - 3$

15. $y = \frac{1}{3} \tan(-2x - \pi) + 1$

16. $y = \sec\left(x - \frac{\pi}{2}\right)$

17. $y = -\csc\left(x + \frac{\pi}{3}\right)$

18. $y = -\frac{1}{3} \sec\left(\frac{1}{2}x + \frac{\pi}{3}\right)$

19. $y = \csc(2x - \pi)$

20. $y = \sec(3x - 2\pi) + 4$

21. $y = \csc\left(-x - \frac{\pi}{4}\right) - 2$

22. $y = \cot\left(x + \frac{\pi}{6}\right)$

23. $y = -11 \cot\left(\frac{1}{5}x\right)$

24. $y = \frac{1}{3} \cot\left(2x + \frac{3\pi}{2}\right) + 1$

In Exercises 25 - 34, use Example 8.5.3 as a guide to show that the function is a sinusoid by rewriting it in the forms $C(x) = A \cos(\omega x + \phi) + B$ and $S(x) = A \sin(\omega x + \phi) + B$ for $\omega > 0$ and $0 \leq \phi < 2\pi$.

25. $f(x) = \sqrt{2} \sin(x) + \sqrt{2} \cos(x) + 1$

26. $f(x) = 3\sqrt{3} \sin(3x) - 3 \cos(3x)$

27. $f(x) = -\sin(x) + \cos(x) - 2$

28. $f(x) = -\frac{1}{2} \sin(2x) - \frac{\sqrt{3}}{2} \cos(2x)$

29. $f(x) = 2\sqrt{3} \cos(x) - 2 \sin(x)$

30. $f(x) = \frac{3}{2} \cos(2x) - \frac{3\sqrt{3}}{2} \sin(2x) + 6$

31. $f(x) = -\frac{1}{2} \cos(5x) - \frac{\sqrt{3}}{2} \sin(5x)$

32. $f(x) = -6\sqrt{3} \cos(3x) - 6 \sin(3x) - 3$

$$33. f(x) = \frac{5\sqrt{2}}{2} \sin(x) - \frac{5\sqrt{2}}{2} \cos(x) \qquad 34. f(x) = 3 \sin\left(\frac{x}{6}\right) - 3\sqrt{3} \cos\left(\frac{x}{6}\right)$$

35. In Exercises 25 - 34, you should have noticed a relationship between the phases ϕ for the $S(x)$ and $C(x)$. Show that if $f(x) = A \sin(\omega x + \alpha) + B$, then $f(x) = A \cos(\omega x + \beta) + B$ where $\beta = \alpha - \frac{\pi}{2}$.

36. Let ϕ be an angle measured in radians and let $P(a, b)$ be a point on the terminal side of ϕ when it is drawn in standard position. Use Theorem 8.3 and the sum identity for sine in Theorem 8.15 to show that $f(x) = a \sin(\omega x) + b \cos(\omega x) + B$ (with $\omega > 0$) can be rewritten as $f(x) = \sqrt{a^2 + b^2} \sin(\omega x + \phi) + B$.

37. With the help of your classmates, express the domains of the functions in Examples 8.5.4 and 8.5.5 using extended interval notation. (We will revisit this in Section 8.7.)

In Exercises 38 - 43, verify the identity by graphing the right and left hand sides on a calculator.

$$38. \sin^2(x) + \cos^2(x) = 1 \qquad 39. \sec^2(x) - \tan^2(x) = 1 \qquad 40. \cos(x) = \sin\left(\frac{\pi}{2} - x\right)$$

$$41. \tan(x + \pi) = \tan(x) \qquad 42. \sin(2x) = 2 \sin(x) \cos(x) \qquad 43. \tan\left(\frac{x}{2}\right) = \frac{\sin(x)}{1 + \cos(x)}$$

In Exercises 44 - 50, graph the function with the help of your calculator and discuss the given questions with your classmates.

44. $f(x) = \cos(3x) + \sin(x)$. Is this function periodic? If so, what is the period?

45. $f(x) = \frac{\sin(x)}{x}$. What appears to be the horizontal asymptote of the graph?

46. $f(x) = x \sin(x)$. Graph $y = \pm x$ on the same set of axes and describe the behavior of f .

47. $f(x) = \sin\left(\frac{1}{x}\right)$. What's happening as $x \rightarrow 0$?

48. $f(x) = x - \tan(x)$. Graph $y = x$ on the same set of axes and describe the behavior of f .

49. $f(x) = e^{-0.1x} (\cos(2x) + \sin(2x))$. Graph $y = \pm e^{-0.1x}$ on the same set of axes and describe the behavior of f .

50. $f(x) = e^{-0.1x} (\cos(2x) + 2 \sin(x))$. Graph $y = \pm e^{-0.1x}$ on the same set of axes and describe the behavior of f .

51. Show that a constant function f is periodic by showing that $f(x + 117) = f(x)$ for all real numbers x . Then show that f has no period by showing that you cannot find a *smallest* number p such that $f(x + p) = f(x)$ for all real numbers x . Said another way, show that $f(x + p) = f(x)$ for all real numbers x for ALL values of $p > 0$, so no smallest value exists to satisfy the definition of 'period'.

8.5.5 ANSWERS

1. $y = 3 \sin(x)$
 Period: 2π
 Amplitude: 3
 Phase Shift: 0
 Vertical Shift: 0

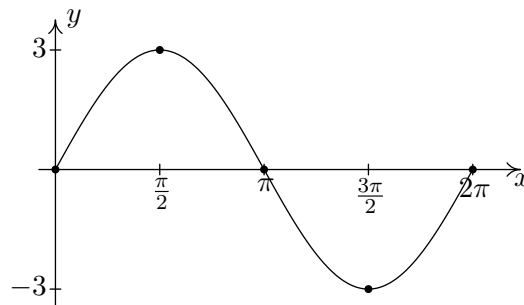

2. $y = \sin(3x)$
 Period: $\frac{2\pi}{3}$
 Amplitude: 1
 Phase Shift: 0
 Vertical Shift: 0

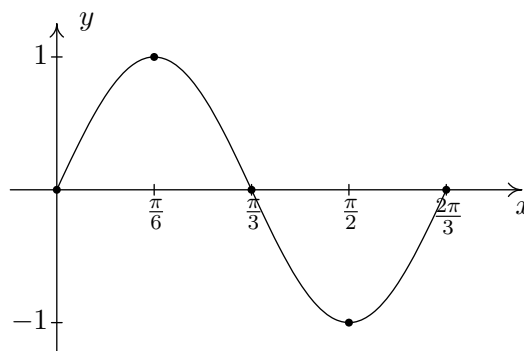

3. $y = -2 \cos(x)$
 Period: 2π
 Amplitude: 2
 Phase Shift: 0
 Vertical Shift: 0

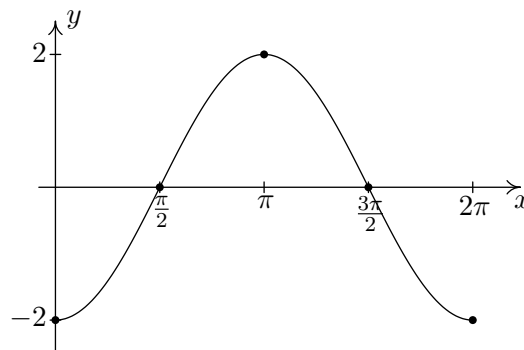

4. $y = \cos\left(x - \frac{\pi}{2}\right)$
 Period: 2π
 Amplitude: 1
 Phase Shift: $\frac{\pi}{2}$
 Vertical Shift: 0

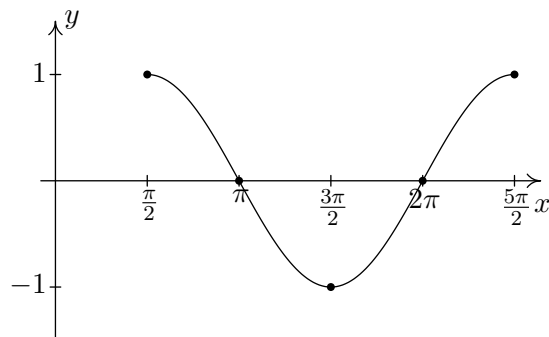

5. $y = -\sin\left(x + \frac{\pi}{3}\right)$

Period: 2π

Amplitude: 1

Phase Shift: $-\frac{\pi}{3}$

Vertical Shift: 0

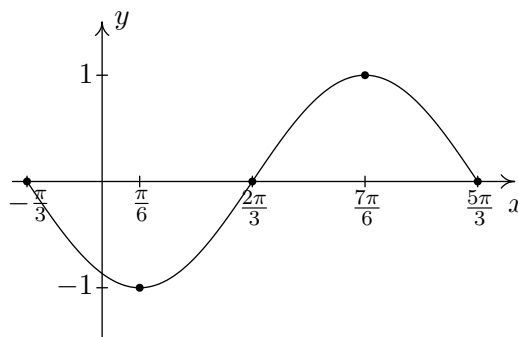

6. $y = \sin(2x - \pi)$

Period: π

Amplitude: 1

Phase Shift: $\frac{\pi}{2}$

Vertical Shift: 0

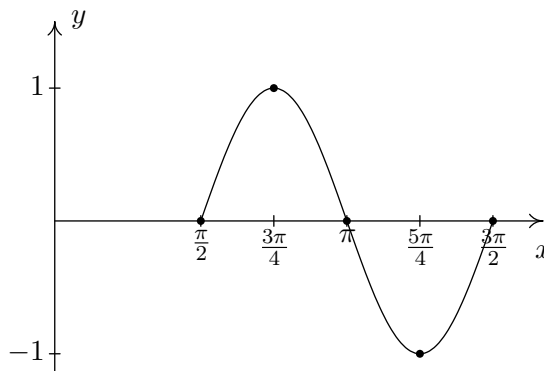

7. $y = -\frac{1}{3}\cos\left(\frac{1}{2}x + \frac{\pi}{3}\right)$

Period: 4π

Amplitude: $\frac{1}{3}$

Phase Shift: $-\frac{2\pi}{3}$

Vertical Shift: 0

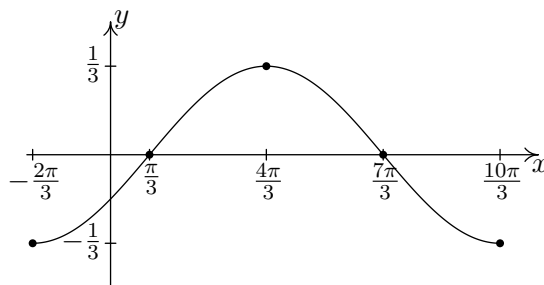

8. $y = \cos(3x - 2\pi) + 4$

Period: $\frac{2\pi}{3}$

Amplitude: 1

Phase Shift: $\frac{2\pi}{3}$

Vertical Shift: 4

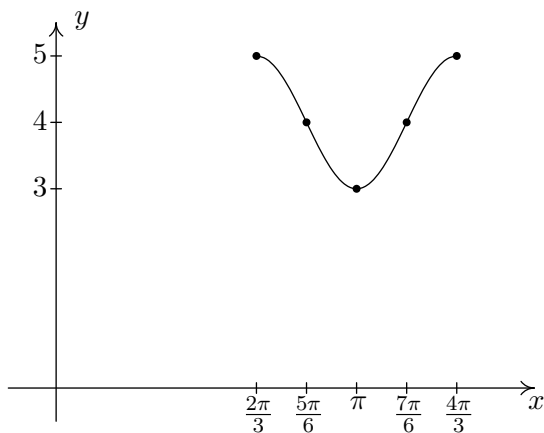

9. $y = \sin\left(-x - \frac{\pi}{4}\right) - 2$

Period: 2π

Amplitude: 1

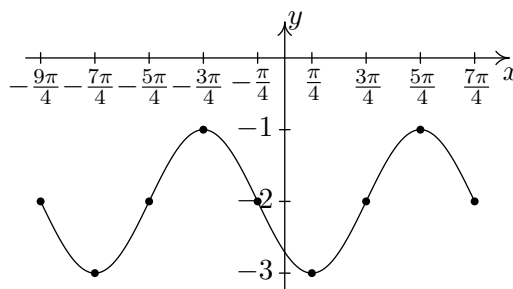
Phase Shift: $-\frac{\pi}{4}$ (You need to use $y = -\sin\left(x + \frac{\pi}{4}\right) - 2$ to find this.)¹⁴Vertical Shift: -2 

10. $y = \frac{2}{3} \cos\left(\frac{\pi}{2} - 4x\right) + 1$

Period: $\frac{\pi}{2}$ Amplitude: $\frac{2}{3}$ Phase Shift: $\frac{\pi}{8}$ (You need to use $y = \frac{2}{3} \cos\left(4x - \frac{\pi}{2}\right) + 1$ to find this.)¹⁵

Vertical Shift: 1

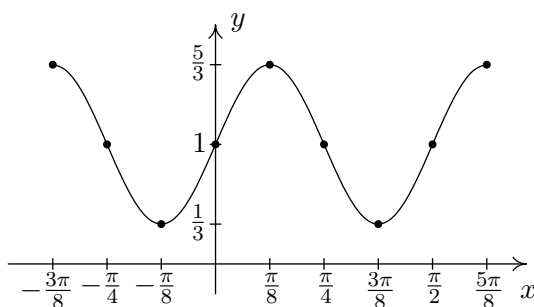

11. $y = -\frac{3}{2} \cos\left(2x + \frac{\pi}{3}\right) - \frac{1}{2}$

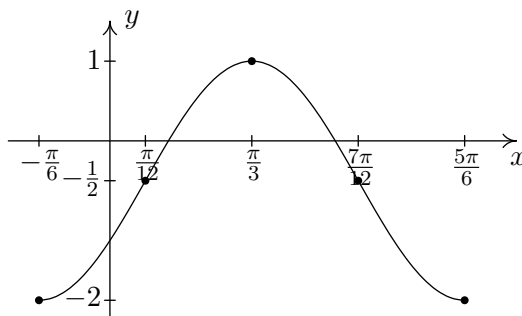
Period: π Amplitude: $\frac{3}{2}$ Phase Shift: $-\frac{\pi}{6}$ Vertical Shift: $-\frac{1}{2}$ 

12. $y = 4 \sin(-2\pi x + \pi)$

Period: 1

Amplitude: 4

Phase Shift: $\frac{1}{2}$ (You need to use $y = -4 \sin(2\pi x - \pi)$ to find this.)¹⁶

Vertical Shift: 0

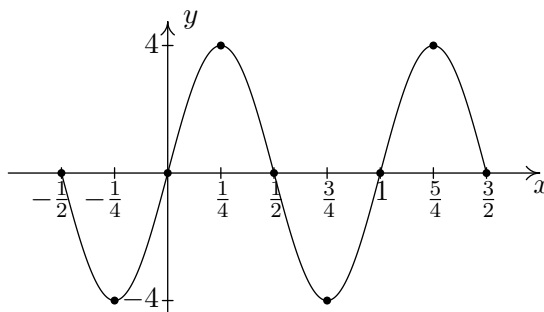
¹⁴Two cycles of the graph are shown to illustrate the discrepancy discussed on page 764.¹⁵Again, we graph two cycles to illustrate the discrepancy discussed on page 764.¹⁶This will be the last time we graph two cycles to illustrate the discrepancy discussed on page 764.

13. $y = \tan\left(x - \frac{\pi}{3}\right)$
 Period: π

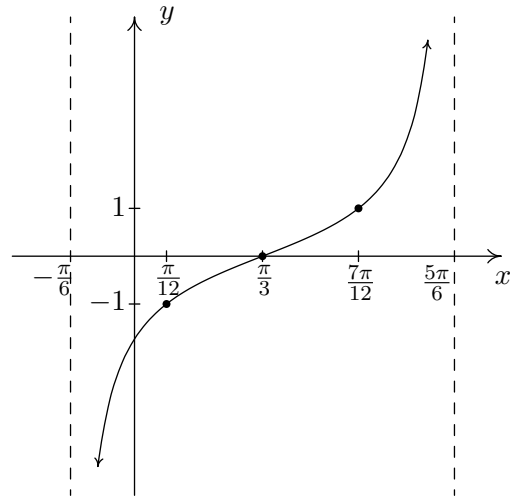

14. $y = 2 \tan\left(\frac{1}{4}x\right) - 3$
 Period: 4π

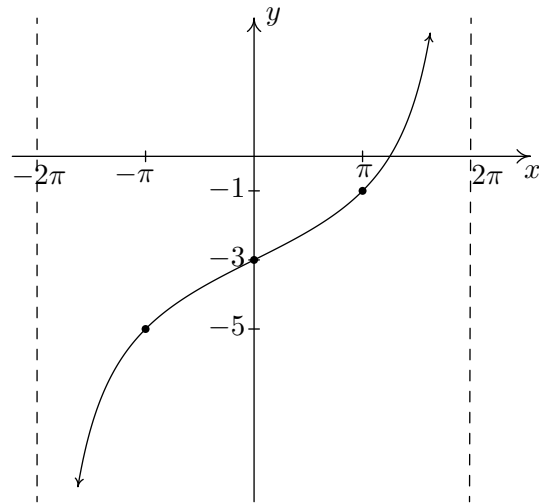

15. $y = \frac{1}{3} \tan(-2x - \pi) + 1$
 is equivalent to
 $y = -\frac{1}{3} \tan(2x + \pi) + 1$
 via the Even / Odd identity for tangent.
 Period: $\frac{\pi}{2}$

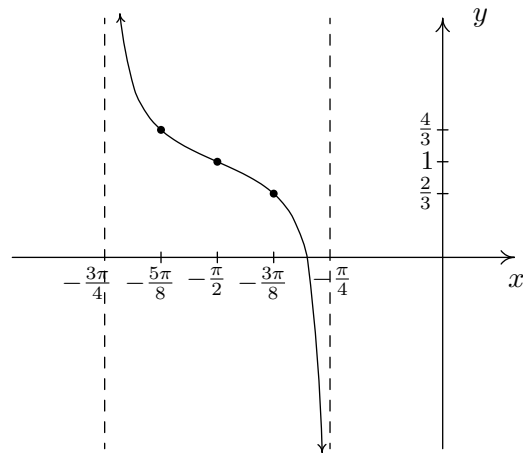

16. $y = \sec\left(x - \frac{\pi}{2}\right)$
 Start with $y = \cos\left(x - \frac{\pi}{2}\right)$
 Period: 2π

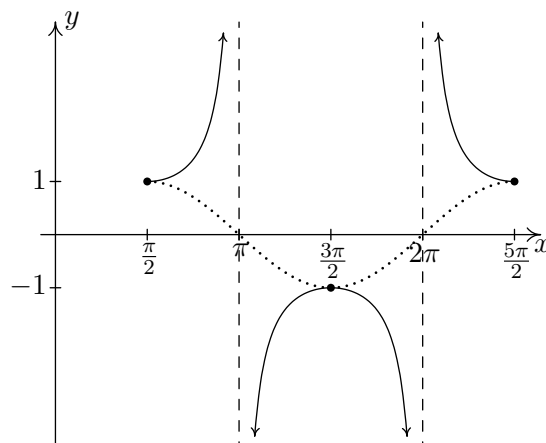

17. $y = -\csc\left(x + \frac{\pi}{3}\right)$
 Start with $y = -\sin\left(x + \frac{\pi}{3}\right)$
 Period: 2π

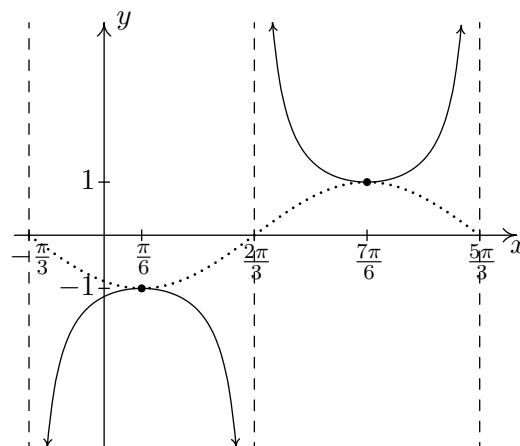

18. $y = -\frac{1}{3}\sec\left(\frac{1}{2}x + \frac{\pi}{3}\right)$
 Start with $y = -\frac{1}{3}\cos\left(\frac{1}{2}x + \frac{\pi}{3}\right)$
 Period: 4π

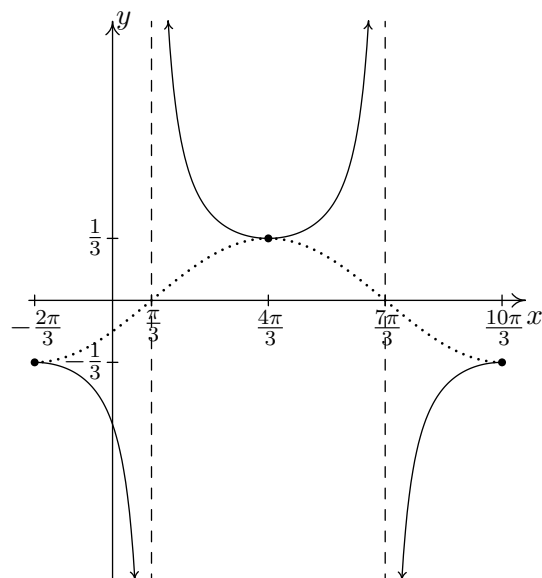

19. $y = \csc(2x - \pi)$
 Start with $y = \sin(2x - \pi)$
 Period: π

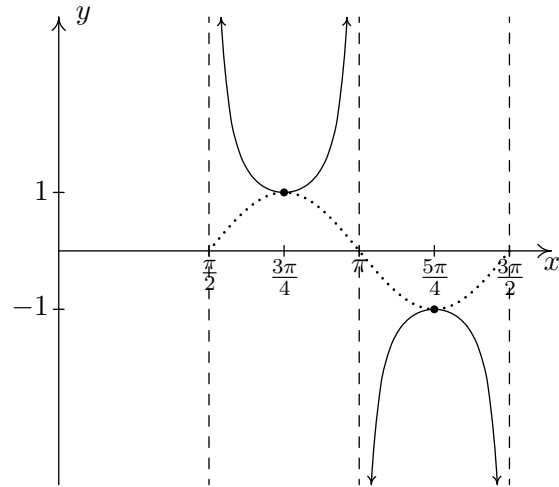

20. $y = \sec(3x - 2\pi) + 4$
 Start with $y = \cos(3x - 2\pi) + 4$
 Period: $\frac{2\pi}{3}$

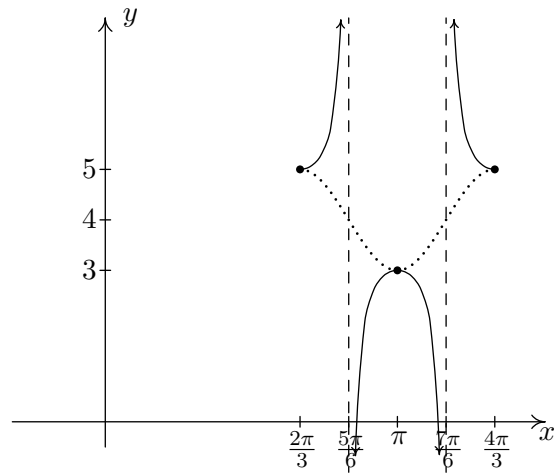

21. $y = \csc\left(-x - \frac{\pi}{4}\right) - 2$
 Start with $y = \sin\left(-x - \frac{\pi}{4}\right) - 2$
 Period: 2π

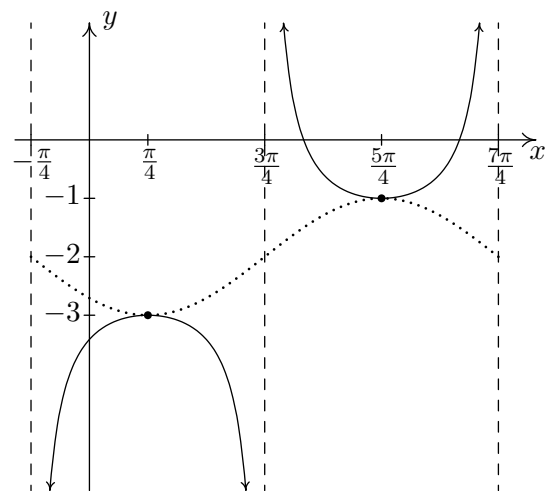

22. $y = \cot\left(x + \frac{\pi}{6}\right)$
 Period: π

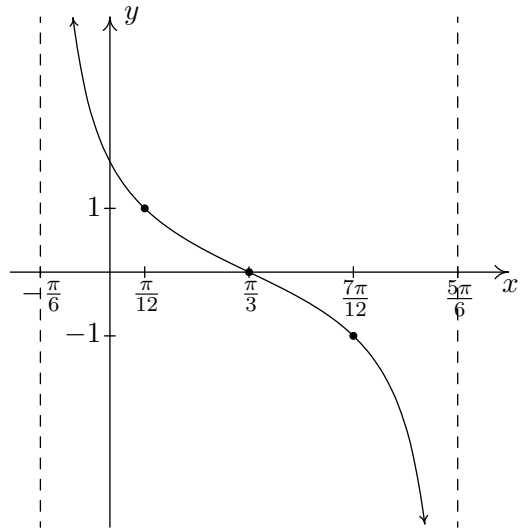

23. $y = -11 \cot\left(\frac{1}{5}x\right)$
 Period: 5π

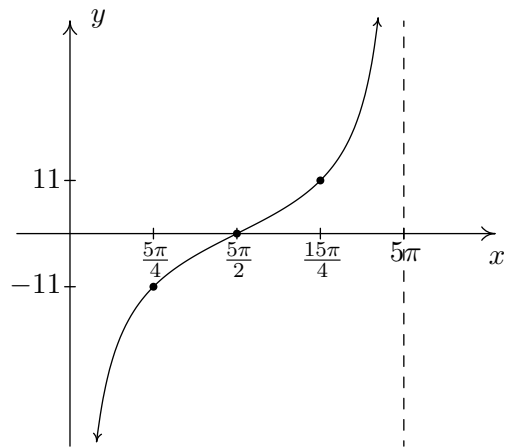

24. $y = \frac{1}{3} \cot\left(2x + \frac{3\pi}{2}\right) + 1$
 Period: $\frac{\pi}{2}$

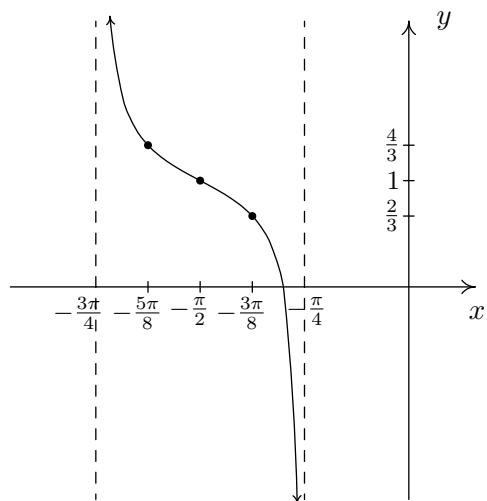

$$25. f(x) = \sqrt{2} \sin(x) + \sqrt{2} \cos(x) + 1 = 2 \sin\left(x + \frac{\pi}{4}\right) + 1 = 2 \cos\left(x + \frac{7\pi}{4}\right) + 1$$

$$26. f(x) = 3\sqrt{3} \sin(3x) - 3 \cos(3x) = 6 \sin\left(3x + \frac{11\pi}{6}\right) = 6 \cos\left(3x + \frac{4\pi}{3}\right)$$

$$27. f(x) = -\sin(x) + \cos(x) - 2 = \sqrt{2} \sin\left(x + \frac{3\pi}{4}\right) - 2 = \sqrt{2} \cos\left(x + \frac{\pi}{4}\right) - 2$$

$$28. f(x) = -\frac{1}{2} \sin(2x) - \frac{\sqrt{3}}{2} \cos(2x) = \sin\left(2x + \frac{4\pi}{3}\right) = \cos\left(2x + \frac{5\pi}{6}\right)$$

$$29. f(x) = 2\sqrt{3} \cos(x) - 2 \sin(x) = 4 \sin\left(x + \frac{2\pi}{3}\right) = 4 \cos\left(x + \frac{\pi}{6}\right)$$

$$30. f(x) = \frac{3}{2} \cos(2x) - \frac{3\sqrt{3}}{2} \sin(2x) + 6 = 3 \sin\left(2x + \frac{5\pi}{6}\right) + 6 = 3 \cos\left(2x + \frac{\pi}{3}\right) + 6$$

$$31. f(x) = -\frac{1}{2} \cos(5x) - \frac{\sqrt{3}}{2} \sin(5x) = \sin\left(5x + \frac{7\pi}{6}\right) = \cos\left(5x + \frac{2\pi}{3}\right)$$

$$32. f(x) = -6\sqrt{3} \cos(3x) - 6 \sin(3x) - 3 = 12 \sin\left(3x + \frac{4\pi}{3}\right) - 3 = 12 \cos\left(3x + \frac{5\pi}{6}\right) - 3$$

$$33. f(x) = \frac{5\sqrt{2}}{2} \sin(x) - \frac{5\sqrt{2}}{2} \cos(x) = 5 \sin\left(x + \frac{7\pi}{4}\right) = 5 \cos\left(x + \frac{5\pi}{4}\right)$$

$$34. f(x) = 3 \sin\left(\frac{x}{6}\right) - 3\sqrt{3} \cos\left(\frac{x}{6}\right) = 6 \sin\left(\frac{x}{6} + \frac{5\pi}{3}\right) = 6 \cos\left(\frac{x}{6} + \frac{7\pi}{6}\right)$$

8.6 THE INVERSE TRIGONOMETRIC FUNCTIONS

As the title indicates, in this section we concern ourselves with finding inverses of the (circular) trigonometric functions. Our immediate problem is that, owing to their periodic nature, none of the six circular functions is one-to-one. To remedy this, we restrict the domains of the circular functions in the same way we restricted the domain of the quadratic function in Example 5.2.3 in Section 5.2 to obtain a one-to-one function. We first consider $f(x) = \cos(x)$. Choosing the interval $[0, \pi]$ allows us to keep the range as $[-1, 1]$ as well as the properties of being smooth and continuous.

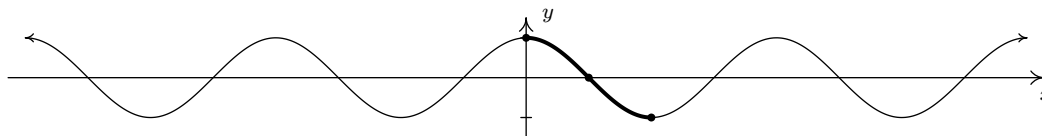

Restricting the domain of $f(x) = \cos(x)$ to $[0, \pi]$.

Recall from Section 5.2 that the inverse of a function f is typically denoted f^{-1} . For this reason, some textbooks use the notation $f^{-1}(x) = \cos^{-1}(x)$ for the inverse of $f(x) = \cos(x)$. The obvious pitfall here is our convention of writing $(\cos(x))^2$ as $\cos^2(x)$, $(\cos(x))^3$ as $\cos^3(x)$ and so on. It is far too easy to confuse $\cos^{-1}(x)$ with $\frac{1}{\cos(x)} = \sec(x)$ so we will not use this notation in our text.¹ Instead, we use the notation $f^{-1}(x) = \arccos(x)$, read ‘arc-cosine of x ’. To understand the ‘arc’ in ‘arccosine’, recall that an inverse function, by definition, reverses the process of the original function. The function $f(t) = \cos(t)$ takes a real number input t , associates it with the angle $\theta = t$ radians, and returns the value $\cos(\theta)$. Digging deeper,² we have that $\cos(\theta) = \cos(t)$ is the x -coordinate of the terminal point on the Unit Circle of an oriented arc of length $|t|$ whose initial point is $(1, 0)$. Hence, we may view the inputs to $f(t) = \cos(t)$ as oriented arcs and the outputs as x -coordinates on the Unit Circle. The function f^{-1} , then, would take x -coordinates on the Unit Circle and return oriented arcs, hence the ‘arc’ in arccosine. Below are the graphs of $f(x) = \cos(x)$ and $f^{-1}(x) = \arccos(x)$, where we obtain the latter from the former by reflecting it across the line $y = x$, in accordance with Theorem 5.3.

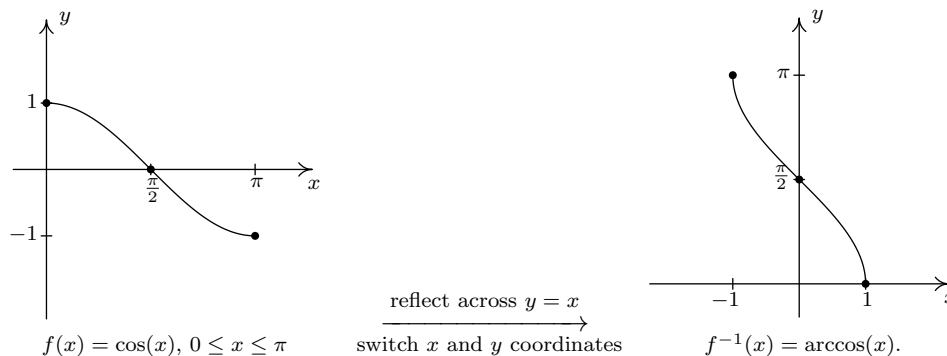

¹But be aware that many books do! As always, be sure to check the context!

²See page 672 if you need a review of how we associate real numbers with angles in radian measure.

We restrict $g(x) = \sin(x)$ in a similar manner, although the interval of choice is $[-\frac{\pi}{2}, \frac{\pi}{2}]$.

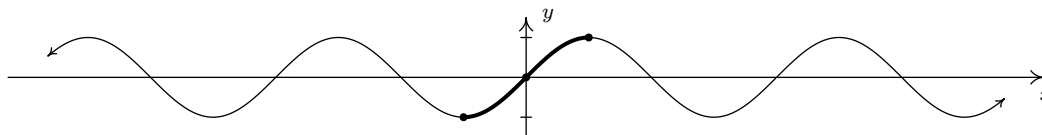

Restricting the domain of $f(x) = \sin(x)$ to $[-\frac{\pi}{2}, \frac{\pi}{2}]$.

It should be no surprise that we call $g^{-1}(x) = \arcsin(x)$, which is read 'arc-sine of x '.

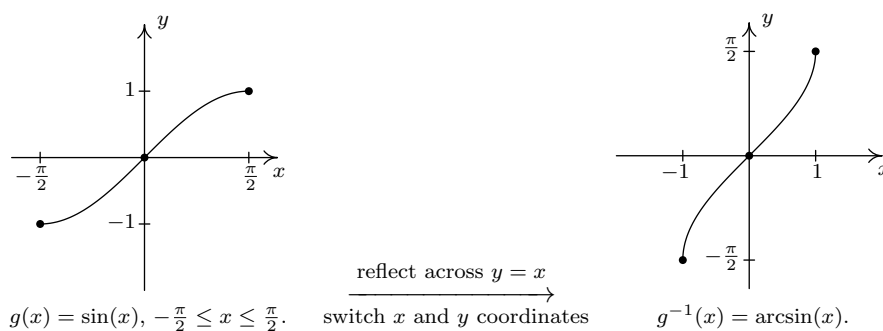

We list some important facts about the arccosine and arcsine functions in the following theorem.

Theorem 8.26. Properties of the Arccosine and Arcsine Functions

- Properties of $F(x) = \arccos(x)$
 - Domain: $[-1, 1]$
 - Range: $[0, \pi]$
 - $\arccos(x) = t$ if and only if $0 \leq t \leq \pi$ and $\cos(t) = x$
 - $\cos(\arccos(x)) = x$ provided $-1 \leq x \leq 1$
 - $\arccos(\cos(x)) = x$ provided $0 \leq x \leq \pi$
- Properties of $G(x) = \arcsin(x)$
 - Domain: $[-1, 1]$
 - Range: $[-\frac{\pi}{2}, \frac{\pi}{2}]$
 - $\arcsin(x) = t$ if and only if $-\frac{\pi}{2} \leq t \leq \frac{\pi}{2}$ and $\sin(t) = x$
 - $\sin(\arcsin(x)) = x$ provided $-1 \leq x \leq 1$
 - $\arcsin(\sin(x)) = x$ provided $-\frac{\pi}{2} \leq x \leq \frac{\pi}{2}$
 - additionally, arcsine is odd

Everything in Theorem 8.26 is a direct consequence of the facts that $f(x) = \cos(x)$ for $0 \leq x \leq \pi$ and $F(x) = \arccos(x)$ are inverses of each other as are $g(x) = \sin(x)$ for $-\frac{\pi}{2} \leq x \leq \frac{\pi}{2}$ and $G(x) = \arcsin(x)$. It's about time for an example.

Example 8.6.1.

1. Find the exact values of the following.

(a) $\arccos\left(\frac{1}{2}\right)$

(b) $\arcsin\left(\frac{\sqrt{2}}{2}\right)$

(c) $\arccos\left(-\frac{\sqrt{2}}{2}\right)$

(d) $\arcsin\left(-\frac{1}{2}\right)$

(e) $\arccos\left(\cos\left(\frac{\pi}{6}\right)\right)$

(f) $\arccos\left(\cos\left(\frac{11\pi}{6}\right)\right)$

(g) $\cos\left(\arccos\left(-\frac{3}{5}\right)\right)$

(h) $\sin\left(\arccos\left(-\frac{3}{5}\right)\right)$

2. Rewrite the following as algebraic expressions of x and state the domain on which the equivalence is valid.

(a) $\tan(\arccos(x))$

(b) $\cos(2 \arcsin(x))$

Solution.

1. (a) To find $\arccos\left(\frac{1}{2}\right)$, we need to find the real number t (or, equivalently, an angle measuring t radians) which lies between 0 and π with $\cos(t) = \frac{1}{2}$. We know $t = \frac{\pi}{3}$ meets these criteria, so $\arccos\left(\frac{1}{2}\right) = \frac{\pi}{3}$.
- (b) The value of $\arcsin\left(\frac{\sqrt{2}}{2}\right)$ is a real number t between $-\frac{\pi}{2}$ and $\frac{\pi}{2}$ with $\sin(t) = \frac{\sqrt{2}}{2}$. The number we seek is $t = \frac{\pi}{4}$. Hence, $\arcsin\left(\frac{\sqrt{2}}{2}\right) = \frac{\pi}{4}$.
- (c) The number $t = \arccos\left(-\frac{\sqrt{2}}{2}\right)$ lies in the interval $[0, \pi]$ with $\cos(t) = -\frac{\sqrt{2}}{2}$. Our answer is $\arccos\left(-\frac{\sqrt{2}}{2}\right) = \frac{3\pi}{4}$.
- (d) To find $\arcsin\left(-\frac{1}{2}\right)$, we seek the number t in the interval $\left[-\frac{\pi}{2}, \frac{\pi}{2}\right]$ with $\sin(t) = -\frac{1}{2}$. The answer is $t = -\frac{\pi}{6}$ so that $\arcsin\left(-\frac{1}{2}\right) = -\frac{\pi}{6}$.
- (e) Since $0 \leq \frac{\pi}{6} \leq \pi$, we could simply invoke Theorem 8.26 to get $\arccos\left(\cos\left(\frac{\pi}{6}\right)\right) = \frac{\pi}{6}$. However, in order to make sure we understand *why* this is the case, we choose to work the example through using the definition of arccosine. Working from the inside out, $\arccos\left(\cos\left(\frac{\pi}{6}\right)\right) = \arccos\left(\frac{\sqrt{3}}{2}\right)$. Now, $\arccos\left(\frac{\sqrt{3}}{2}\right)$ is the real number t with $0 \leq t \leq \pi$ and $\cos(t) = \frac{\sqrt{3}}{2}$. We find $t = \frac{\pi}{6}$, so that $\arccos\left(\cos\left(\frac{\pi}{6}\right)\right) = \frac{\pi}{6}$.

- (f) Since $\frac{11\pi}{6}$ does not fall between 0 and π , Theorem 8.26 does not apply. We are forced to work through from the inside out starting with $\arccos(\cos(\frac{11\pi}{6})) = \arccos(\frac{\sqrt{3}}{2})$. From the previous problem, we know $\arccos(\frac{\sqrt{3}}{2}) = \frac{\pi}{6}$. Hence, $\arccos(\cos(\frac{11\pi}{6})) = \frac{\pi}{6}$.
- (g) One way to simplify $\cos(\arccos(-\frac{3}{5}))$ is to use Theorem 8.26 directly. Since $-\frac{3}{5}$ is between -1 and 1 , we have that $\cos(\arccos(-\frac{3}{5})) = -\frac{3}{5}$ and we are done. However, as before, to really understand *why* this cancellation occurs, we let $t = \arccos(-\frac{3}{5})$. Then, by definition, $\cos(t) = -\frac{3}{5}$. Hence, $\cos(\arccos(-\frac{3}{5})) = \cos(t) = -\frac{3}{5}$, and we are finished in (nearly) the same amount of time.
- (h) As in the previous example, we let $t = \arccos(-\frac{3}{5})$ so that $\cos(t) = -\frac{3}{5}$ for some t where $0 \leq t \leq \pi$. Since $\cos(t) < 0$, we can narrow this down a bit and conclude that $\frac{\pi}{2} < t < \pi$, so that t corresponds to an angle in Quadrant II. In terms of t , then, we need to find $\sin(\arccos(-\frac{3}{5})) = \sin(t)$. Using the Pythagorean Identity $\cos^2(t) + \sin^2(t) = 1$, we get $(-\frac{3}{5})^2 + \sin^2(t) = 1$ or $\sin(t) = \pm\frac{4}{5}$. Since t corresponds to a Quadrants II angle, we choose $\sin(t) = \frac{4}{5}$. Hence, $\sin(\arccos(-\frac{3}{5})) = \frac{4}{5}$.
2. (a) We begin this problem in the same manner we began the previous two problems. To help us see the forest for the trees, we let $t = \arccos(x)$, so our goal is to find a way to express $\tan(\arccos(x)) = \tan(t)$ in terms of x . Since $t = \arccos(x)$, we know $\cos(t) = x$ where $0 \leq t \leq \pi$, but since we are after an expression for $\tan(t)$, we know we need to throw out $t = \frac{\pi}{2}$ from consideration. Hence, either $0 \leq t < \frac{\pi}{2}$ or $\frac{\pi}{2} < t \leq \pi$ so that, geometrically, t corresponds to an angle in Quadrant I or Quadrant II. One approach³ to finding $\tan(t)$ is to use the quotient identity $\tan(t) = \frac{\sin(t)}{\cos(t)}$. Substituting $\cos(t) = x$ into the Pythagorean Identity $\cos^2(t) + \sin^2(t) = 1$ gives $x^2 + \sin^2(t) = 1$, from which we get $\sin(t) = \pm\sqrt{1-x^2}$. Since t corresponds to angles in Quadrants I and II, $\sin(t) \geq 0$, so we choose $\sin(t) = \sqrt{1-x^2}$. Thus,

$$\tan(t) = \frac{\sin(t)}{\cos(t)} = \frac{\sqrt{1-x^2}}{x}$$

To determine the values of x for which this equivalence is valid, we consider our substitution $t = \arccos(x)$. Since the domain of $\arccos(x)$ is $[-1, 1]$, we know we must restrict $-1 \leq x \leq 1$. Additionally, since we had to discard $t = \frac{\pi}{2}$, we need to discard $x = \cos(\frac{\pi}{2}) = 0$. Hence, $\tan(\arccos(x)) = \frac{\sqrt{1-x^2}}{x}$ is valid for x in $[-1, 0) \cup (0, 1]$.

- (b) We proceed as in the previous problem by writing $t = \arcsin(x)$ so that t lies in the interval $[-\frac{\pi}{2}, \frac{\pi}{2}]$ with $\sin(t) = x$. We aim to express $\cos(2\arcsin(x)) = \cos(2t)$ in terms of x . Since $\cos(2t)$ is defined everywhere, we get no additional restrictions on t as we did in the previous problem. We have three choices for rewriting $\cos(2t)$: $\cos^2(t) - \sin^2(t)$, $2\cos^2(t) - 1$ and $1 - 2\sin^2(t)$. Since we know $x = \sin(t)$, it is easiest to use the last form:

$$\cos(2\arcsin(x)) = \cos(2t) = 1 - 2\sin^2(t) = 1 - 2x^2$$

³Alternatively, we could use the identity: $1 + \tan^2(t) = \sec^2(t)$. Since $x = \cos(t)$, $\sec(t) = \frac{1}{\cos(t)} = \frac{1}{x}$. The reader is invited to work through this approach to see what, if any, difficulties arise.

To find the restrictions on x , we once again appeal to our substitution $t = \arcsin(x)$. Since $\arcsin(x)$ is defined only for $-1 \leq x \leq 1$, the equivalence $\cos(2 \arcsin(x)) = 1 - 2x^2$ is valid only on $[-1, 1]$. \square

A few remarks about Example 8.6.1 are in order. Most of the common errors encountered in dealing with the inverse circular functions come from the need to restrict the domains of the original functions so that they are one-to-one. One instance of this phenomenon is the fact that $\arccos(\cos(\frac{11\pi}{6})) = \frac{\pi}{6}$ as opposed to $\frac{11\pi}{6}$. This is the exact same phenomenon discussed in Section 5.2 when we saw $\sqrt{(-2)^2} = 2$ as opposed to -2 . Additionally, even though the expression we arrived at in part 2b above, namely $1 - 2x^2$, is defined for all real numbers, the equivalence $\cos(2 \arcsin(x)) = 1 - 2x^2$ is valid for only $-1 \leq x \leq 1$. This is akin to the fact that while the expression x is defined for all real numbers, the equivalence $(\sqrt{x})^2 = x$ is valid only for $x \geq 0$. For this reason, it pays to be careful when we determine the intervals where such equivalences are valid.

The next pair of functions we wish to discuss are the inverses of tangent and cotangent, which are named arctangent and arccotangent, respectively. First, we restrict $f(x) = \tan(x)$ to its fundamental cycle on $(-\frac{\pi}{2}, \frac{\pi}{2})$ to obtain $f^{-1}(x) = \arctan(x)$. Among other things, note that the *vertical* asymptotes $x = -\frac{\pi}{2}$ and $x = \frac{\pi}{2}$ of the graph of $f(x) = \tan(x)$ become the *horizontal* asymptotes $y = -\frac{\pi}{2}$ and $y = \frac{\pi}{2}$ of the graph of $f^{-1}(x) = \arctan(x)$.

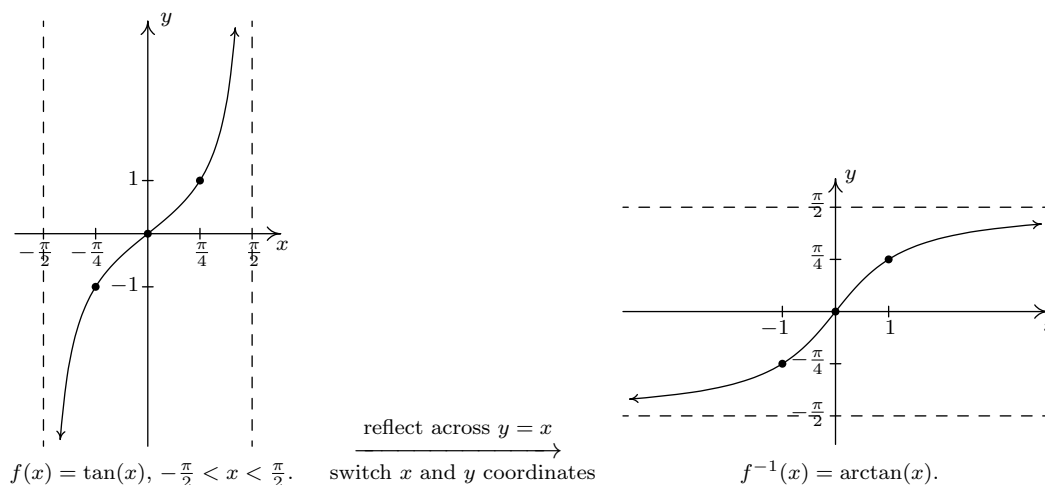

Next, we restrict $g(x) = \cot(x)$ to its fundamental cycle on $(0, \pi)$ to obtain $g^{-1}(x) = \operatorname{arccot}(x)$. Once again, the vertical asymptotes $x = 0$ and $x = \pi$ of the graph of $g(x) = \cot(x)$ become the horizontal asymptotes $y = 0$ and $y = \pi$ of the graph of $g^{-1}(x) = \operatorname{arccot}(x)$. We show these graphs on the next page and list some of the basic properties of the arctangent and arccotangent functions.

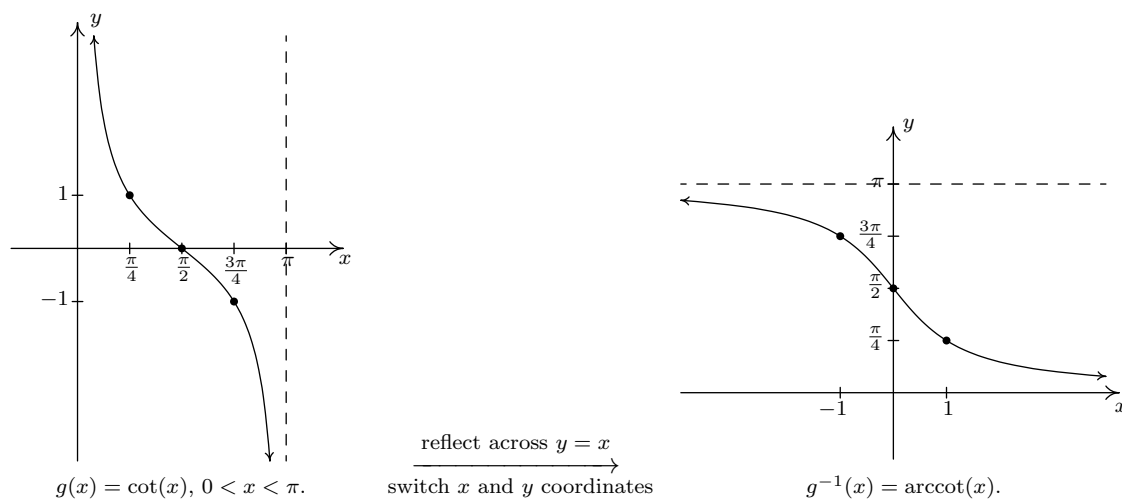

Theorem 8.27. Properties of the Arctangent and Arccotangent Functions

- Properties of $F(x) = \arctan(x)$

- Domain: $(-\infty, \infty)$
- Range: $(-\frac{\pi}{2}, \frac{\pi}{2})$
- as $x \rightarrow -\infty$, $\arctan(x) \rightarrow -\frac{\pi}{2}^+$; as $x \rightarrow \infty$, $\arctan(x) \rightarrow \frac{\pi}{2}^-$
- $\arctan(x) = t$ if and only if $-\frac{\pi}{2} < t < \frac{\pi}{2}$ and $\tan(t) = x$
- $\arctan(x) = \operatorname{arccot}(\frac{1}{x})$ for $x > 0$
- $\tan(\arctan(x)) = x$ for all real numbers x
- $\arctan(\tan(x)) = x$ provided $-\frac{\pi}{2} < x < \frac{\pi}{2}$
- additionally, arctangent is odd

- Properties of $G(x) = \operatorname{arccot}(x)$

- Domain: $(-\infty, \infty)$
- Range: $(0, \pi)$
- as $x \rightarrow -\infty$, $\operatorname{arccot}(x) \rightarrow \pi^-$; as $x \rightarrow \infty$, $\operatorname{arccot}(x) \rightarrow 0^+$
- $\operatorname{arccot}(x) = t$ if and only if $0 < t < \pi$ and $\cot(t) = x$
- $\operatorname{arccot}(x) = \arctan(\frac{1}{x})$ for $x > 0$
- $\cot(\operatorname{arccot}(x)) = x$ for all real numbers x
- $\operatorname{arccot}(\cot(x)) = x$ provided $0 < x < \pi$

Example 8.6.2.

1. Find the exact values of the following.

(a) $\arctan(\sqrt{3})$

(b) $\operatorname{arccot}(-\sqrt{3})$

(c) $\cot(\operatorname{arccot}(-5))$

(d) $\sin\left(\arctan\left(-\frac{3}{4}\right)\right)$

2. Rewrite the following as algebraic expressions of x and state the domain on which the equivalence is valid.

(a) $\tan(2 \arctan(x))$

(b) $\cos(\operatorname{arccot}(2x))$

Solution.

1. (a) We know $\arctan(\sqrt{3})$ is the real number t between $-\frac{\pi}{2}$ and $\frac{\pi}{2}$ with $\tan(t) = \sqrt{3}$. We find $t = \frac{\pi}{3}$, so $\arctan(\sqrt{3}) = \frac{\pi}{3}$.
- (b) The real number $t = \operatorname{arccot}(-\sqrt{3})$ lies in the interval $(0, \pi)$ with $\cot(t) = -\sqrt{3}$. We get $\operatorname{arccot}(-\sqrt{3}) = \frac{5\pi}{6}$.
- (c) We can apply Theorem 8.27 directly and obtain $\cot(\operatorname{arccot}(-5)) = -5$. However, working it through provides us with yet another opportunity to understand why this is the case. Letting $t = \operatorname{arccot}(-5)$, we have that t belongs to the interval $(0, \pi)$ and $\cot(t) = -5$. Hence, $\cot(\operatorname{arccot}(-5)) = \cot(t) = -5$.
- (d) We start simplifying $\sin\left(\arctan\left(-\frac{3}{4}\right)\right)$ by letting $t = \arctan\left(-\frac{3}{4}\right)$. Then $\tan(t) = -\frac{3}{4}$ for some $-\frac{\pi}{2} < t < \frac{\pi}{2}$. Since $\tan(t) < 0$, we know, in fact, $-\frac{\pi}{2} < t < 0$. One way to proceed is to use The Pythagorean Identity, $1 + \cot^2(t) = \csc^2(t)$, since this relates the reciprocals of $\tan(t)$ and $\sin(t)$ and is valid for all t under consideration.⁴ From $\tan(t) = -\frac{3}{4}$, we get $\cot(t) = -\frac{4}{3}$. Substituting, we get $1 + \left(-\frac{4}{3}\right)^2 = \csc^2(t)$ so that $\csc(t) = \pm\frac{5}{3}$. Since $-\frac{\pi}{2} < t < 0$, we choose $\csc(t) = -\frac{5}{3}$, so $\sin(t) = -\frac{3}{5}$. Hence, $\sin\left(\arctan\left(-\frac{3}{4}\right)\right) = -\frac{3}{5}$.
2. (a) If we let $t = \arctan(x)$, then $-\frac{\pi}{2} < t < \frac{\pi}{2}$ and $\tan(t) = x$. We look for a way to express $\tan(2 \arctan(x)) = \tan(2t)$ in terms of x . Before we get started using identities, we note that $\tan(2t)$ is undefined when $2t = \frac{\pi}{2} + \pi k$ for integers k . Dividing both sides of this equation by 2 tells us we need to exclude values of t where $t = \frac{\pi}{4} + \frac{\pi}{2}k$, where k is an integer. The only members of this family which lie in $(-\frac{\pi}{2}, \frac{\pi}{2})$ are $t = \pm\frac{\pi}{4}$, which means the values of t under consideration are $(-\frac{\pi}{2}, -\frac{\pi}{4}) \cup (-\frac{\pi}{4}, \frac{\pi}{4}) \cup (\frac{\pi}{4}, \frac{\pi}{2})$. Returning to $\arctan(2t)$, we note the double angle identity $\tan(2t) = \frac{2 \tan(t)}{1 - \tan^2(t)}$, is valid for all the values of t under consideration, hence we get

$$\tan(2 \arctan(x)) = \tan(2t) = \frac{2 \tan(t)}{1 - \tan^2(t)} = \frac{2x}{1 - x^2}$$

⁴It's always a good idea to make sure the identities used in these situations are valid for all values t under consideration. Check our work back in Example 8.6.1. Were the identities we used there valid for all t under consideration? A pedantic point, to be sure, but what else do you expect from this book?

To find where this equivalence is valid we check back with our substitution $t = \arctan(x)$. Since the domain of $\arctan(x)$ is all real numbers, the only exclusions come from the values of t we discarded earlier, $t = \pm\frac{\pi}{4}$. Since $x = \tan(t)$, this means we exclude $x = \tan(\pm\frac{\pi}{4}) = \pm 1$. Hence, the equivalence $\tan(2\arctan(x)) = \frac{2x}{1-x^2}$ holds for all x in $(-\infty, -1) \cup (-1, 1) \cup (1, \infty)$.

- (b) To get started, we let $t = \operatorname{arccot}(2x)$ so that $\cot(t) = 2x$ where $0 < t < \pi$. In terms of t , $\cos(\operatorname{arccot}(2x)) = \cos(t)$, and our goal is to express the latter in terms of x . Since $\cos(t)$ is always defined, there are no additional restrictions on t , so we can begin using identities to relate $\cot(t)$ to $\cos(t)$. The identity $\cot(t) = \frac{\cos(t)}{\sin(t)}$ is valid for t in $(0, \pi)$, so our strategy is to obtain $\sin(t)$ in terms of x , then write $\cos(t) = \cot(t)\sin(t)$. The identity $1 + \cot^2(t) = \csc^2(t)$ holds for all t in $(0, \pi)$ and relates $\cot(t)$ and $\csc(t) = \frac{1}{\sin(t)}$. Substituting $\cot(t) = 2x$, we get $1 + (2x)^2 = \csc^2(t)$, or $\csc(t) = \pm\sqrt{4x^2 + 1}$. Since t is between 0 and π , $\csc(t) > 0$, so $\csc(t) = \sqrt{4x^2 + 1}$ which gives $\sin(t) = \frac{1}{\sqrt{4x^2 + 1}}$. Hence,

$$\cos(\operatorname{arccot}(2x)) = \cos(t) = \cot(t)\sin(t) = \frac{2x}{\sqrt{4x^2 + 1}}$$

Since $\operatorname{arccot}(2x)$ is defined for all real numbers x and we encountered no additional restrictions on t , we have $\cos(\operatorname{arccot}(2x)) = \frac{2x}{\sqrt{4x^2 + 1}}$ for all real numbers x . \square

The last two functions to invert are secant and cosecant. A portion of each of their graphs, which were first discussed in Subsection 8.5.2, are given below with the fundamental cycles highlighted.

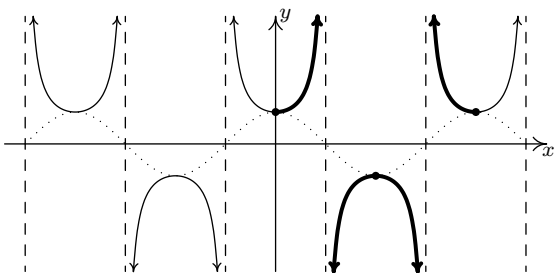

The graph of $y = \sec(x)$.

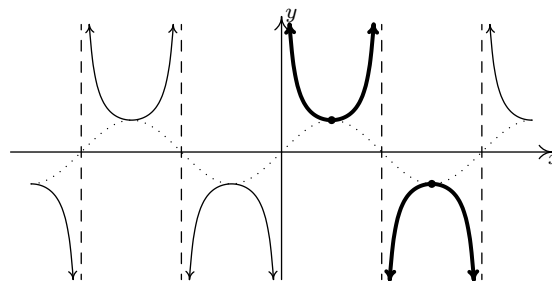

The graph of $y = \csc(x)$.

It is clear from the graph of secant that we cannot find one single continuous piece of its graph which covers its entire range of $(-\infty, -1] \cup [1, \infty)$ and restricts the domain of the function so that it is one-to-one. The same is true for cosecant. Thus in order to define the arcsecant and arccosecant functions, we must settle for a piecewise approach wherein we choose one piece to cover the top of the range, namely $[1, \infty)$, and another piece to cover the bottom, namely $(-\infty, -1]$. There are two generally accepted ways make these choices which restrict the domains of these functions so that they are one-to-one. One approach simplifies the Trigonometry associated with the inverse functions, but complicates the Calculus; the other makes the Calculus easier, but the Trigonometry less so. We present both points of view.

8.6.1 INVERSES OF SECANT AND COSECANT: TRIGONOMETRY FRIENDLY APPROACH

In this subsection, we restrict the secant and cosecant functions to coincide with the restrictions on cosine and sine, respectively. For $f(x) = \sec(x)$, we restrict the domain to $[0, \frac{\pi}{2}) \cup (\frac{\pi}{2}, \pi]$

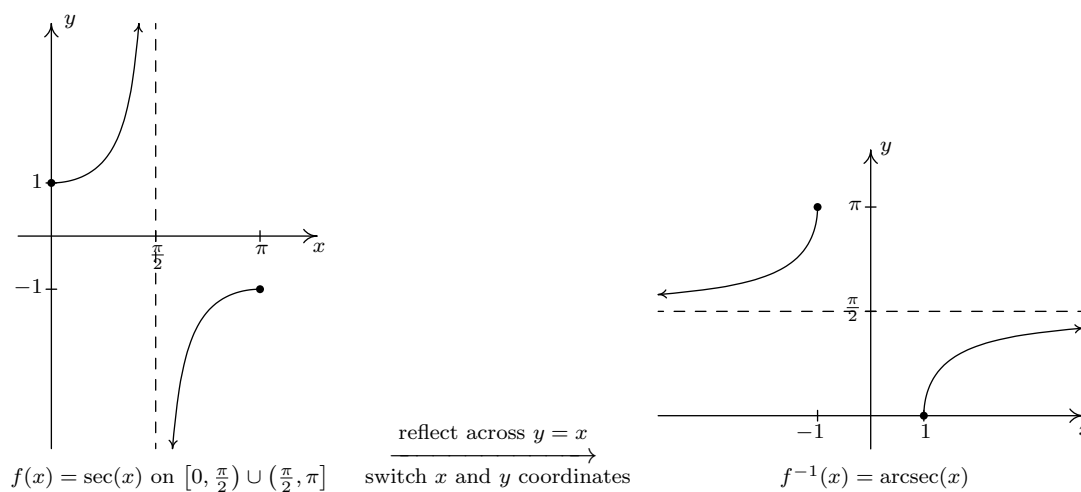

and we restrict $g(x) = \csc(x)$ to $[-\frac{\pi}{2}, 0) \cup (0, \frac{\pi}{2}]$.

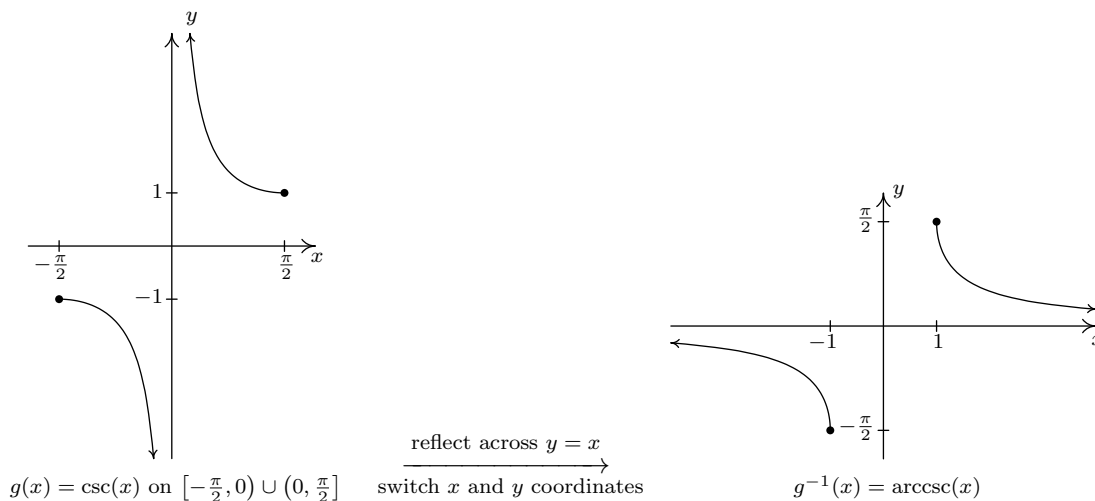

Note that for both arcsecant and arccosecant, the domain is $(-\infty, -1] \cup [1, \infty)$. Taking a page from Section 2.2, we can rewrite this as $\{x : |x| \geq 1\}$. This is often done in Calculus textbooks, so we include it here for completeness. Using these definitions, we get the following properties of the arcsecant and arccosecant functions.

Theorem 8.28. Properties of the Arcsecant and Arccosecant Functions^a

- Properties of $F(x) = \operatorname{arcsec}(x)$
 - Domain: $\{x : |x| \geq 1\} = (-\infty, -1] \cup [1, \infty)$
 - Range: $[0, \frac{\pi}{2}) \cup (\frac{\pi}{2}, \pi]$
 - as $x \rightarrow -\infty$, $\operatorname{arcsec}(x) \rightarrow \frac{\pi}{2}^+$; as $x \rightarrow \infty$, $\operatorname{arcsec}(x) \rightarrow \frac{\pi}{2}^-$
 - $\operatorname{arcsec}(x) = t$ if and only if $0 \leq t < \frac{\pi}{2}$ or $\frac{\pi}{2} < t \leq \pi$ and $\sec(t) = x$
 - $\operatorname{arcsec}(x) = \arccos(\frac{1}{x})$ provided $|x| \geq 1$
 - $\sec(\operatorname{arcsec}(x)) = x$ provided $|x| \geq 1$
 - $\operatorname{arcsec}(\sec(x)) = x$ provided $0 \leq x < \frac{\pi}{2}$ or $\frac{\pi}{2} < x \leq \pi$
- Properties of $G(x) = \operatorname{arccsc}(x)$
 - Domain: $\{x : |x| \geq 1\} = (-\infty, -1] \cup [1, \infty)$
 - Range: $[-\frac{\pi}{2}, 0) \cup (0, \frac{\pi}{2}]$
 - as $x \rightarrow -\infty$, $\operatorname{arccsc}(x) \rightarrow 0^-$; as $x \rightarrow \infty$, $\operatorname{arccsc}(x) \rightarrow 0^+$
 - $\operatorname{arccsc}(x) = t$ if and only if $-\frac{\pi}{2} \leq t < 0$ or $0 < t \leq \frac{\pi}{2}$ and $\csc(t) = x$
 - $\operatorname{arccsc}(x) = \arcsin(\frac{1}{x})$ provided $|x| \geq 1$
 - $\csc(\operatorname{arccsc}(x)) = x$ provided $|x| \geq 1$
 - $\operatorname{arccsc}(\csc(x)) = x$ provided $-\frac{\pi}{2} \leq x < 0$ or $0 < x \leq \frac{\pi}{2}$
 - additionally, arccosecant is odd

^a...assuming the “Trigonometry Friendly” ranges are used.**Example 8.6.3.**

1. Find the exact values of the following.

(a) $\operatorname{arcsec}(2)$ (b) $\operatorname{arccsc}(-2)$ (c) $\operatorname{arcsec}(\sec(\frac{5\pi}{4}))$ (d) $\cot(\operatorname{arccsc}(-3))$

2. Rewrite the following as algebraic expressions of x and state the domain on which the equivalence is valid.

(a) $\tan(\operatorname{arcsec}(x))$ (b) $\cos(\operatorname{arccsc}(4x))$

Solution.

1. (a) Using Theorem 8.28, we have $\operatorname{arcsec}(2) = \arccos\left(\frac{1}{2}\right) = \frac{\pi}{3}$.
 - (b) Once again, Theorem 8.28 comes to our aid giving $\operatorname{arccsc}(-2) = \arcsin\left(-\frac{1}{2}\right) = -\frac{\pi}{6}$.
 - (c) Since $\frac{5\pi}{4}$ doesn't fall between 0 and $\frac{\pi}{2}$ or $\frac{\pi}{2}$ and π , we cannot use the inverse property stated in Theorem 8.28. We can, nevertheless, begin by working 'inside out' which yields $\operatorname{arcsec}\left(\sec\left(\frac{5\pi}{4}\right)\right) = \operatorname{arcsec}(-\sqrt{2}) = \arccos\left(-\frac{\sqrt{2}}{2}\right) = \frac{3\pi}{4}$.
 - (d) One way to begin to simplify $\cot(\operatorname{arccsc}(-3))$ is to let $t = \operatorname{arccsc}(-3)$. Then, $\csc(t) = -3$ and, since this is negative, we have that t lies in the interval $[-\frac{\pi}{2}, 0)$. We are after $\cot(\operatorname{arccsc}(-3)) = \cot(t)$, so we use the Pythagorean Identity $1 + \cot^2(t) = \csc^2(t)$. Substituting, we have $1 + \cot^2(t) = (-3)^2$, or $\cot(t) = \pm\sqrt{8} = \pm 2\sqrt{2}$. Since $-\frac{\pi}{2} \leq t < 0$, $\cot(t) < 0$, so we get $\cot(\operatorname{arccsc}(-3)) = -2\sqrt{2}$.
2. (a) We begin simplifying $\tan(\operatorname{arcsec}(x))$ by letting $t = \operatorname{arcsec}(x)$. Then, $\sec(t) = x$ for t in $[0, \frac{\pi}{2}) \cup (\frac{\pi}{2}, \pi]$, and we seek a formula for $\tan(t)$. Since $\tan(t)$ is defined for all t values under consideration, we have no additional restrictions on t . To relate $\sec(t)$ to $\tan(t)$, we use the identity $1 + \tan^2(t) = \sec^2(t)$. This is valid for all values of t under consideration, and when we substitute $\sec(t) = x$, we get $1 + \tan^2(t) = x^2$. Hence, $\tan(t) = \pm\sqrt{x^2 - 1}$. If t belongs to $[0, \frac{\pi}{2})$ then $\tan(t) \geq 0$; if, on the other hand, t belongs to $(\frac{\pi}{2}, \pi]$ then $\tan(t) \leq 0$. As a result, we get a piecewise defined function for $\tan(t)$

$$\tan(t) = \begin{cases} \sqrt{x^2 - 1}, & \text{if } 0 \leq t < \frac{\pi}{2} \\ -\sqrt{x^2 - 1}, & \text{if } \frac{\pi}{2} < t \leq \pi \end{cases}$$

Now we need to determine what these conditions on t mean for x . Since $x = \sec(t)$, when $0 \leq t < \frac{\pi}{2}$, $x \geq 1$, and when $\frac{\pi}{2} < t \leq \pi$, $x \leq -1$. Since we encountered no further restrictions on t , the equivalence below holds for all x in $(-\infty, -1] \cup [1, \infty)$.

$$\tan(\operatorname{arcsec}(x)) = \begin{cases} \sqrt{x^2 - 1}, & \text{if } x \geq 1 \\ -\sqrt{x^2 - 1}, & \text{if } x \leq -1 \end{cases}$$

- (b) To simplify $\cos(\operatorname{arccsc}(4x))$, we start by letting $t = \operatorname{arccsc}(4x)$. Then $\csc(t) = 4x$ for t in $[-\frac{\pi}{2}, 0) \cup (0, \frac{\pi}{2}]$, and we now set about finding an expression for $\cos(\operatorname{arccsc}(4x)) = \cos(t)$. Since $\cos(t)$ is defined for all t , we do not encounter any additional restrictions on t . From $\csc(t) = 4x$, we get $\sin(t) = \frac{1}{4x}$, so to find $\cos(t)$, we can make use of the identity $\cos^2(t) + \sin^2(t) = 1$. Substituting $\sin(t) = \frac{1}{4x}$ gives $\cos^2(t) + \left(\frac{1}{4x}\right)^2 = 1$. Solving, we get

$$\cos(t) = \pm\sqrt{\frac{16x^2 - 1}{16x^2}} = \pm\frac{\sqrt{16x^2 - 1}}{4|x|}$$

Since t belongs to $[-\frac{\pi}{2}, 0) \cup (0, \frac{\pi}{2}]$, we know $\cos(t) \geq 0$, so we choose $\cos(t) = \frac{\sqrt{16x^2 - 1}}{4|x|}$. (The absolute values here are necessary, since x could be negative.) To find the values for

which this equivalence is valid, we look back at our original substitution, $t = \operatorname{arccsc}(4x)$. Since the domain of $\operatorname{arccsc}(x)$ requires its argument x to satisfy $|x| \geq 1$, the domain of $\operatorname{arccsc}(4x)$ requires $|4x| \geq 1$. Using Theorem 2.4, we rewrite this inequality and solve to get $x \leq -\frac{1}{4}$ or $x \geq \frac{1}{4}$. Since we had no additional restrictions on t , the equivalence $\cos(\operatorname{arccsc}(4x)) = \frac{\sqrt{16x^2-1}}{4|x|}$ holds for all x in $(-\infty, -\frac{1}{4}] \cup [\frac{1}{4}, \infty)$. \square

8.6.2 INVERSES OF SECANT AND COSECANT: CALCULUS FRIENDLY APPROACH

In this subsection, we restrict $f(x) = \sec(x)$ to $[0, \frac{\pi}{2}) \cup (\pi, \frac{3\pi}{2})$

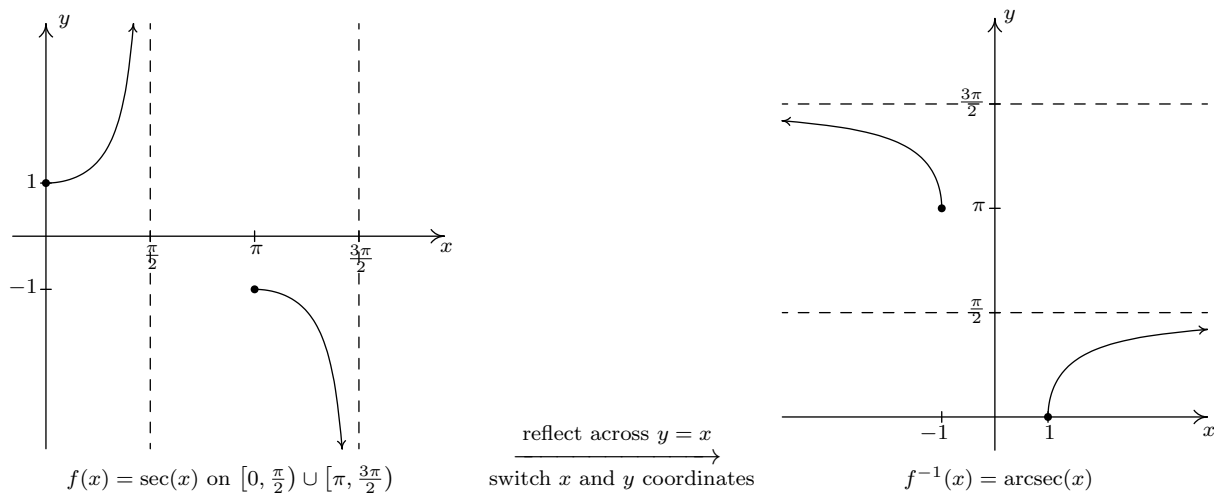

and we restrict $g(x) = \csc(x)$ to $(0, \frac{\pi}{2}] \cup (\pi, \frac{3\pi}{2}]$.

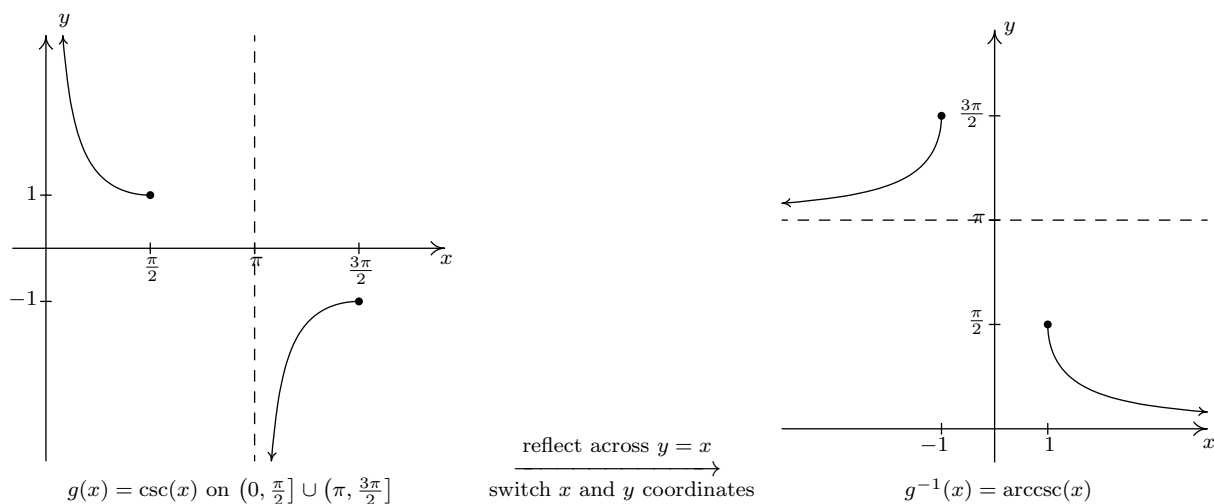

Using these definitions, we get the following result.

Solution.

1. (a) Since $2 \geq 1$, we may invoke Theorem 8.29 to get $\operatorname{arcsec}(2) = \arccos\left(\frac{1}{2}\right) = \frac{\pi}{3}$.
 - (b) Unfortunately, -2 is not greater than or equal to 1, so we cannot apply Theorem 8.29 to $\operatorname{arccsc}(-2)$ and convert this into an arcsine problem. Instead, we appeal to the definition. The real number $t = \operatorname{arccsc}(-2)$ lies in $(0, \frac{\pi}{2}] \cup (\pi, \frac{3\pi}{2}]$ and satisfies $\csc(t) = -2$. The t we're after is $t = \frac{7\pi}{6}$, so $\operatorname{arccsc}(-2) = \frac{7\pi}{6}$.
 - (c) Since $\frac{5\pi}{4}$ lies between π and $\frac{3\pi}{2}$, we may apply Theorem 8.29 directly to simplify $\operatorname{arcsec}\left(\sec\left(\frac{5\pi}{4}\right)\right) = \frac{5\pi}{4}$. We encourage the reader to work this through using the definition as we have done in the previous examples to see how it goes.
 - (d) To simplify $\cot(\operatorname{arccsc}(-3))$ we let $t = \operatorname{arccsc}(-3)$ so that $\cot(\operatorname{arccsc}(-3)) = \cot(t)$. We know $\csc(t) = -3$, and since this is negative, t lies in $(\pi, \frac{3\pi}{2}]$. Using the identity $1 + \cot^2(t) = \csc^2(t)$, we find $1 + \cot^2(t) = (-3)^2$ so that $\cot(t) = \pm\sqrt{8} = \pm 2\sqrt{2}$. Since t is in the interval $(\pi, \frac{3\pi}{2}]$, we know $\cot(t) > 0$. Our answer is $\cot(\operatorname{arccsc}(-3)) = 2\sqrt{2}$.
2. (a) We begin simplifying $\tan(\operatorname{arcsec}(x))$ by letting $t = \operatorname{arcsec}(x)$. Then, $\sec(t) = x$ for t in $[0, \frac{\pi}{2}) \cup [\pi, \frac{3\pi}{2})$, and we seek a formula for $\tan(t)$. Since $\tan(t)$ is defined for all t values under consideration, we have no additional restrictions on t . To relate $\sec(t)$ to $\tan(t)$, we use the identity $1 + \tan^2(t) = \sec^2(t)$. This is valid for all values of t under consideration, and when we substitute $\sec(t) = x$, we get $1 + \tan^2(t) = x^2$. Hence, $\tan(t) = \pm\sqrt{x^2 - 1}$. Since t lies in $[0, \frac{\pi}{2}) \cup [\pi, \frac{3\pi}{2})$, $\tan(t) \geq 0$, so we choose $\tan(t) = \sqrt{x^2 - 1}$. Since we found no additional restrictions on t , the equivalence $\tan(\operatorname{arcsec}(x)) = \sqrt{x^2 - 1}$ holds for all x in the domain of $t = \operatorname{arcsec}(x)$, namely $(-\infty, -1] \cup [1, \infty)$.
 - (b) To simplify $\cos(\operatorname{arccsc}(4x))$, we start by letting $t = \operatorname{arccsc}(4x)$. Then $\csc(t) = 4x$ for t in $(0, \frac{\pi}{2}] \cup (\pi, \frac{3\pi}{2}]$, and we now set about finding an expression for $\cos(\operatorname{arccsc}(4x)) = \cos(t)$. Since $\cos(t)$ is defined for all t , we do not encounter any additional restrictions on t . From $\csc(t) = 4x$, we get $\sin(t) = \frac{1}{4x}$, so to find $\cos(t)$, we can make use of the identity $\cos^2(t) + \sin^2(t) = 1$. Substituting $\sin(t) = \frac{1}{4x}$ gives $\cos^2(t) + \left(\frac{1}{4x}\right)^2 = 1$. Solving, we get

$$\cos(t) = \pm\sqrt{\frac{16x^2 - 1}{16x^2}} = \pm\frac{\sqrt{16x^2 - 1}}{4|x|}$$

If t lies in $(0, \frac{\pi}{2}]$, then $\cos(t) \geq 0$, and we choose $\cos(t) = \frac{\sqrt{16x^2 - 1}}{4|x|}$. Otherwise, t belongs to $(\pi, \frac{3\pi}{2}]$ in which case $\cos(t) \leq 0$, so, we choose $\cos(t) = -\frac{\sqrt{16x^2 - 1}}{4|x|}$. This leads us to a (momentarily) piecewise defined function for $\cos(t)$

$$\cos(t) = \begin{cases} \frac{\sqrt{16x^2 - 1}}{4|x|}, & \text{if } 0 \leq t \leq \frac{\pi}{2} \\ -\frac{\sqrt{16x^2 - 1}}{4|x|}, & \text{if } \pi < t \leq \frac{3\pi}{2} \end{cases}$$

We now see what these restrictions mean in terms of x . Since $4x = \csc(t)$, we get that for $0 \leq t \leq \frac{\pi}{2}$, $4x \geq 1$, or $x \geq \frac{1}{4}$. In this case, we can simplify $|x| = x$ so

$$\cos(t) = \frac{\sqrt{16x^2 - 1}}{4|x|} = \frac{\sqrt{16x^2 - 1}}{4x}$$

Similarly, for $\pi < t \leq \frac{3\pi}{2}$, we get $4x \leq -1$, or $x \leq -\frac{1}{4}$. In this case, $|x| = -x$, so we also get

$$\cos(t) = -\frac{\sqrt{16x^2 - 1}}{4|x|} = -\frac{\sqrt{16x^2 - 1}}{4(-x)} = \frac{\sqrt{16x^2 - 1}}{4x}$$

Hence, in all cases, $\cos(\operatorname{arccsc}(4x)) = \frac{\sqrt{16x^2 - 1}}{4x}$, and this equivalence is valid for all x in the domain of $t = \operatorname{arccsc}(4x)$, namely $(-\infty, -\frac{1}{4}] \cup [\frac{1}{4}, \infty)$ \square

8.6.3 CALCULATORS AND THE INVERSE CIRCULAR FUNCTIONS.

In the sections to come, we will have need to approximate the values of the inverse circular functions. On most calculators, only the arcsine, arccosine and arctangent functions are available and they are usually labeled as \sin^{-1} , \cos^{-1} and \tan^{-1} , respectively. If we are asked to approximate these values, it is a simple matter to punch up the appropriate decimal on the calculator. If we are asked for an arccotangent, arcsecant or arccosecant, however, we often need to employ some ingenuity, as our next example illustrates.

Example 8.6.5.

- Use a calculator to approximate the following values to four decimal places.

$$(a) \operatorname{arccot}(2) \qquad (b) \operatorname{arcsec}(5) \qquad (c) \operatorname{arccot}(-2) \qquad (d) \operatorname{arccsc}\left(-\frac{3}{2}\right)$$

- Find the domain and range of the following functions. Check your answers using a calculator.

$$(a) f(x) = \frac{\pi}{2} - \arccos\left(\frac{x}{5}\right) \qquad (b) f(x) = 3 \arctan(4x). \qquad (c) f(x) = \operatorname{arccot}\left(\frac{x}{2}\right) + \pi$$

Solution.

- Since $2 > 0$, we can use the property listed in Theorem 8.27 to rewrite $\operatorname{arccot}(2)$ as $\operatorname{arccot}(2) = \arctan\left(\frac{1}{2}\right)$. In 'radian' mode, we find $\operatorname{arccot}(2) = \arctan\left(\frac{1}{2}\right) \approx 0.4636$.
 - Since $5 \geq 1$, we can use the property from either Theorem 8.28 or Theorem 8.29 to write $\operatorname{arcsec}(5) = \arccos\left(\frac{1}{5}\right) \approx 1.3694$.

$\tan^{-1}(1/2)$
.463647609

$\cos^{-1}(1/5)$
1.369438406

- (c) Since the argument -2 is negative, we cannot directly apply Theorem 8.27 to help us find $\operatorname{arccot}(-2)$. Let $t = \operatorname{arccot}(-2)$. Then t is a real number such that $0 < t < \pi$ and $\cot(t) = -2$. Moreover, since $\cot(t) < 0$, we know $\frac{\pi}{2} < t < \pi$. Geometrically, this means t corresponds to a Quadrant II angle $\theta = t$ radians. This allows us to proceed using a ‘reference angle’ approach. Consider α , the reference angle for θ , as pictured below. By definition, α is an acute angle so $0 < \alpha < \frac{\pi}{2}$, and the Reference Angle Theorem, Theorem 8.2, tells us that $\cot(\alpha) = 2$. This means $\alpha = \operatorname{arccot}(2)$ radians. Since the argument of arccotangent is now a *positive* 2, we can use Theorem 8.27 to get $\alpha = \operatorname{arccot}(2) = \arctan\left(\frac{1}{2}\right)$ radians. Since $\theta = \pi - \alpha = \pi - \arctan\left(\frac{1}{2}\right) \approx 2.6779$ radians, we get $\operatorname{arccot}(-2) \approx 2.6779$.

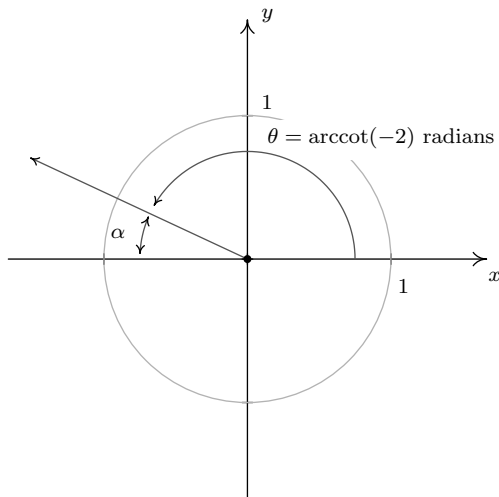

$\pi - \tan^{-1}(1/2)$
2.677945045

Another way to attack the problem is to use $\arctan\left(-\frac{1}{2}\right)$. By definition, the real number $t = \arctan\left(-\frac{1}{2}\right)$ satisfies $\tan(t) = -\frac{1}{2}$ with $-\frac{\pi}{2} < t < \frac{\pi}{2}$. Since $\tan(t) < 0$, we know more specifically that $-\frac{\pi}{2} < t < 0$, so t corresponds to an angle β in Quadrant IV. To find the value of $\operatorname{arccot}(-2)$, we once again visualize the angle $\theta = \operatorname{arccot}(-2)$ radians and note that it is a Quadrant II angle with $\tan(\theta) = -\frac{1}{2}$. This means it is exactly π units away from β , and we get $\theta = \pi + \beta = \pi + \arctan\left(-\frac{1}{2}\right) \approx 2.6779$ radians. Hence, as before, $\operatorname{arccot}(-2) \approx 2.6779$.

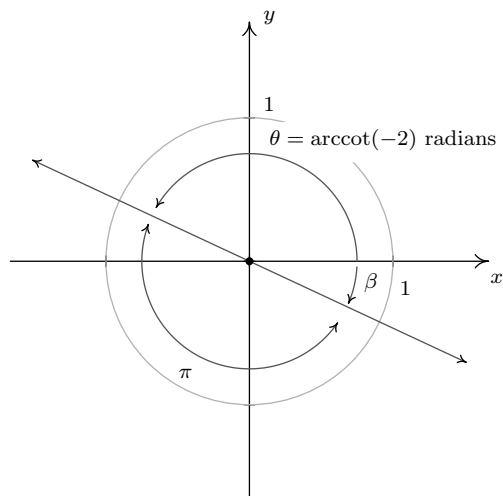

$$\pi + \tan^{-1}(-1/2)$$

$$2.677945045$$

- (d) If the range of arccosecant is taken to be $[-\frac{\pi}{2}, 0) \cup (0, \frac{\pi}{2}]$, we can use Theorem 8.28 to get $\operatorname{arccsc}(-\frac{3}{2}) = \arcsin(-\frac{2}{3}) \approx -0.7297$. If, on the other hand, the range of arccosecant is taken to be $(0, \frac{\pi}{2}] \cup (\pi, \frac{3\pi}{2}]$, then we proceed as in the previous problem by letting $t = \operatorname{arccsc}(-\frac{3}{2})$. Then t is a real number with $\csc(t) = -\frac{3}{2}$. Since $\csc(t) < 0$, we have that $\pi < \theta \leq \frac{3\pi}{2}$, so t corresponds to a Quadrant III angle, θ . As above, we let α be the reference angle for θ . Then $0 < \alpha < \frac{\pi}{2}$ and $\csc(\alpha) = \frac{3}{2}$, which means $\alpha = \operatorname{arccsc}(\frac{3}{2})$ radians. Since the argument of arccosecant is now positive, we may use Theorem 8.29 to get $\alpha = \operatorname{arccsc}(\frac{3}{2}) = \arcsin(\frac{2}{3})$ radians. Since $\theta = \pi + \alpha = \pi + \arcsin(\frac{2}{3}) \approx 3.8713$ radians, $\operatorname{arccsc}(-\frac{3}{2}) \approx 3.8713$.

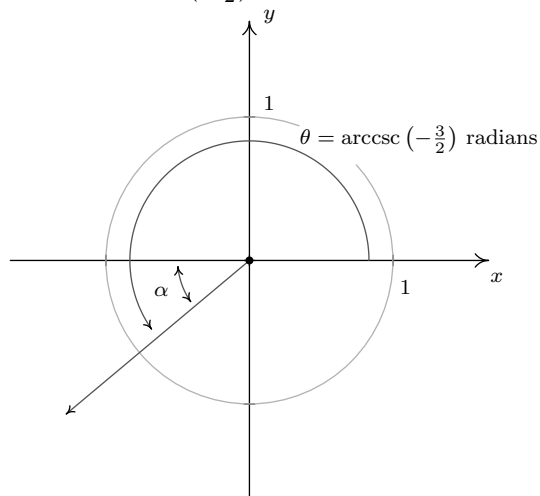

$$\pi + \sin^{-1}(2/3)$$

$$3.87132031$$

2. (a) Since the domain of $F(x) = \arccos(x)$ is $-1 \leq x \leq 1$, we can find the domain of $f(x) = \frac{\pi}{2} - \arccos\left(\frac{x}{5}\right)$ by setting the argument of the arccosine, in this case $\frac{x}{5}$, between -1 and 1 . Solving $-1 \leq \frac{x}{5} \leq 1$ gives $-5 \leq x \leq 5$, so the domain is $[-5, 5]$. To determine the range of f , we take a cue from Section 1.7. Three ‘key’ points on the graph of $F(x) = \arccos(x)$ are $(-1, \pi)$, $(0, \frac{\pi}{2})$ and $(1, 0)$. Following the procedure outlined in Theorem 1.7, we track these points to $(-5, -\frac{\pi}{2})$, $(0, 0)$ and $(5, \frac{\pi}{2})$. Plotting these values tells us that the range⁵ of f is $[-\frac{\pi}{2}, \frac{\pi}{2}]$. Our graph confirms our results.
- (b) To find the domain and range of $f(x) = 3 \arctan(4x)$, we note that since the domain of $F(x) = \arctan(x)$ is all real numbers, the only restrictions, if any, on the domain of $f(x) = 3 \arctan(4x)$ come from the argument of the arctangent, in this case, $4x$. Since $4x$ is defined for all real numbers, we have established that the domain of f is all real numbers. To determine the range of f , we can, once again, appeal to Theorem 1.7. Choosing our ‘key’ point to be $(0, 0)$ and tracking the horizontal asymptotes $y = -\frac{\pi}{2}$ and $y = \frac{\pi}{2}$, we find that the graph of $y = f(x) = 3 \arctan(4x)$ differs from the graph of $y = F(x) = \arctan(x)$ by a horizontal compression by a factor of 4 and a vertical stretch by a factor of 3. It is the latter which affects the range, producing a range of $(-\frac{3\pi}{2}, \frac{3\pi}{2})$. We confirm our findings on the calculator below.

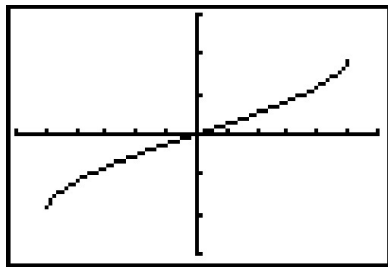

$$y = f(x) = \frac{\pi}{2} - \arccos\left(\frac{x}{5}\right)$$

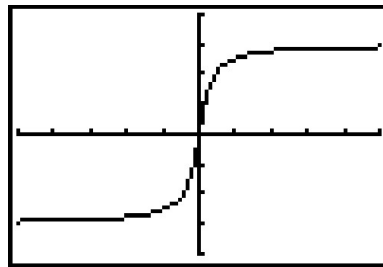

$$y = f(x) = 3 \arctan(4x)$$

- (c) To find the domain of $g(x) = \operatorname{arccot}\left(\frac{x}{2}\right) + \pi$, we proceed as above. Since the domain of $G(x) = \operatorname{arccot}(x)$ is $(-\infty, \infty)$, and $\frac{x}{2}$ is defined for all x , we get that the domain of g is $(-\infty, \infty)$ as well. As for the range, we note that the range of $G(x) = \operatorname{arccot}(x)$, like that of $F(x) = \arctan(x)$, is limited by a pair of horizontal asymptotes, in this case $y = 0$ and $y = \pi$. Following Theorem 1.7, we graph $y = g(x) = \operatorname{arccot}\left(\frac{x}{2}\right) + \pi$ starting with $y = G(x) = \operatorname{arccot}(x)$ and first performing a horizontal expansion by a factor of 2 and following that with a vertical shift upwards by π . This latter transformation is the one which affects the range, making it now $(\pi, 2\pi)$. To check this graphically, we encounter a bit of a problem, since on many calculators, there is no shortcut button corresponding to the arccotangent function. Taking a cue from number 1c, we attempt to rewrite $g(x) = \operatorname{arccot}\left(\frac{x}{2}\right) + \pi$ in terms of the arctangent function. Using Theorem 8.27, we have that $\operatorname{arccot}\left(\frac{x}{2}\right) = \arctan\left(\frac{2}{x}\right)$ when $\frac{x}{2} > 0$, or, in this case, when $x > 0$. Hence, for $x > 0$, we have $g(x) = \arctan\left(\frac{2}{x}\right) + \pi$. When $\frac{x}{2} < 0$, we can use the same argument in number 1c that gave us $\operatorname{arccot}(-2) = \pi + \arctan\left(-\frac{1}{2}\right)$ to give us $\operatorname{arccot}\left(\frac{x}{2}\right) = \pi + \arctan\left(\frac{2}{x}\right)$.

⁵It also confirms our domain!

Hence, for $x < 0$, $g(x) = \pi + \arctan\left(\frac{2}{x}\right) + \pi = \arctan\left(\frac{2}{x}\right) + 2\pi$. What about $x = 0$? We know $g(0) = \operatorname{arccot}(0) + \pi = \pi$, and neither of the formulas for g involving arctangent will produce this result.⁶ Hence, in order to graph $y = g(x)$ on our calculators, we need to write it as a piecewise defined function:

$$g(x) = \operatorname{arccot}\left(\frac{x}{2}\right) + \pi = \begin{cases} \arctan\left(\frac{2}{x}\right) + 2\pi, & \text{if } x < 0 \\ \pi, & \text{if } x = 0 \\ \arctan\left(\frac{2}{x}\right) + \pi, & \text{if } x > 0 \end{cases}$$

We show the input and the result below.

```

Plot1 Plot2 Plot3
\Y1=(tan^-1(2/X)+2
\Y2=(pi)(X=0)
\Y3=(tan^-1(2/X)+pi
)(X>0)
\Y4=
\Y5=

```

$y = g(x)$ in terms of arctangent

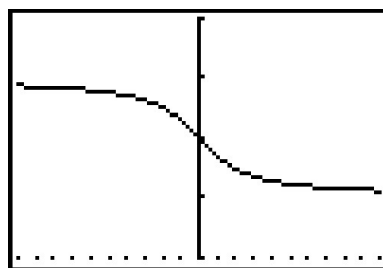

$y = g(x) = \operatorname{arccot}\left(\frac{x}{2}\right) + \pi$

□

The inverse trigonometric functions are typically found in applications whenever the measure of an angle is required. One such scenario is presented in the following example.

Example 8.6.6.⁷ The roof on the house below has a ‘6/12 pitch’. This means that when viewed from the side, the roof line has a rise of 6 feet over a run of 12 feet. Find the angle of inclination from the bottom of the roof to the top of the roof. Express your answer in decimal degrees, rounded to the nearest hundredth of a degree.



Front View



Side View

Solution. If we divide the side view of the house down the middle, we find that the roof line forms the hypotenuse of a right triangle with legs of length 6 feet and 12 feet. Using Theorem 8.10, we

⁶Without Calculus, of course . . .

⁷The authors would like to thank Dan Stitz for this problem and associated graphics.

find the angle of inclination, labeled θ below, satisfies $\tan(\theta) = \frac{6}{12} = \frac{1}{2}$. Since θ is an acute angle, we can use the arctangent function and we find $\theta = \arctan\left(\frac{1}{2}\right)$ radians $\approx 26.56^\circ$.

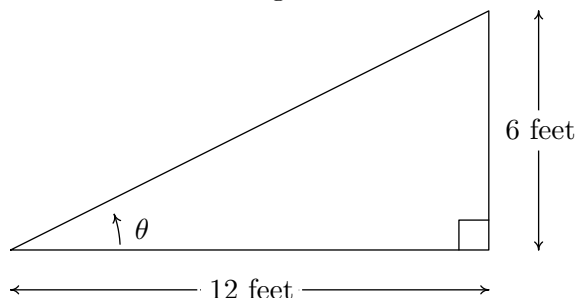

```
tan-1(1/2)
.463647609
Ans*180/π
26.56505118
```

□

8.6.4 SOLVING EQUATIONS USING THE INVERSE TRIGONOMETRIC FUNCTIONS.

In Sections 8.2 and 8.3, we learned how to solve equations like $\sin(\theta) = \frac{1}{2}$ for angles θ and $\tan(t) = -1$ for real numbers t . In each case, we ultimately appealed to the Unit Circle and relied on the fact that the answers corresponded to a set of ‘common angles’ listed on page 692. If, on the other hand, we had been asked to find all angles with $\sin(\theta) = \frac{1}{3}$ or solve $\tan(t) = -2$ for real numbers t , we would have been hard-pressed to do so. With the introduction of the inverse trigonometric functions, however, we are now in a position to solve these equations. A good parallel to keep in mind is how the square root function can be used to solve certain quadratic equations. The equation $x^2 = 4$ is a lot like $\sin(\theta) = \frac{1}{2}$ in that it has friendly, ‘common value’ answers $x = \pm 2$. The equation $x^2 = 7$, on the other hand, is a lot like $\sin(\theta) = \frac{1}{3}$. We know⁸ there are answers, but we can’t express them using ‘friendly’ numbers.⁹ To solve $x^2 = 7$, we make use of the square root function and write $x = \pm\sqrt{7}$. We can certainly *approximate* these answers using a calculator, but as far as exact answers go, we leave them as $x = \pm\sqrt{7}$. In the same way, we will use the arcsine function to solve $\sin(\theta) = \frac{1}{3}$, as seen in the following example.

Example 8.6.7. Solve the following equations.

1. Find all angles θ for which $\sin(\theta) = \frac{1}{3}$.
2. Find all real numbers t for which $\tan(t) = -2$
3. Solve $\sec(x) = -\frac{5}{3}$ for x .

Solution.

1. If $\sin(\theta) = \frac{1}{3}$, then the terminal side of θ , when plotted in standard position, intersects the Unit Circle at $y = \frac{1}{3}$. Geometrically, we see that this happens at two places: in Quadrant I and Quadrant II. If we let α denote the acute solution to the equation, then all the solutions

⁸How do we know this again?

⁹This is all, of course, a matter of opinion. For the record, the authors find $\pm\sqrt{7}$ just as ‘nice’ as ± 2 .

to this equation in Quadrant I are coterminal with α , and α serves as the reference angle for all of the solutions to this equation in Quadrant II.

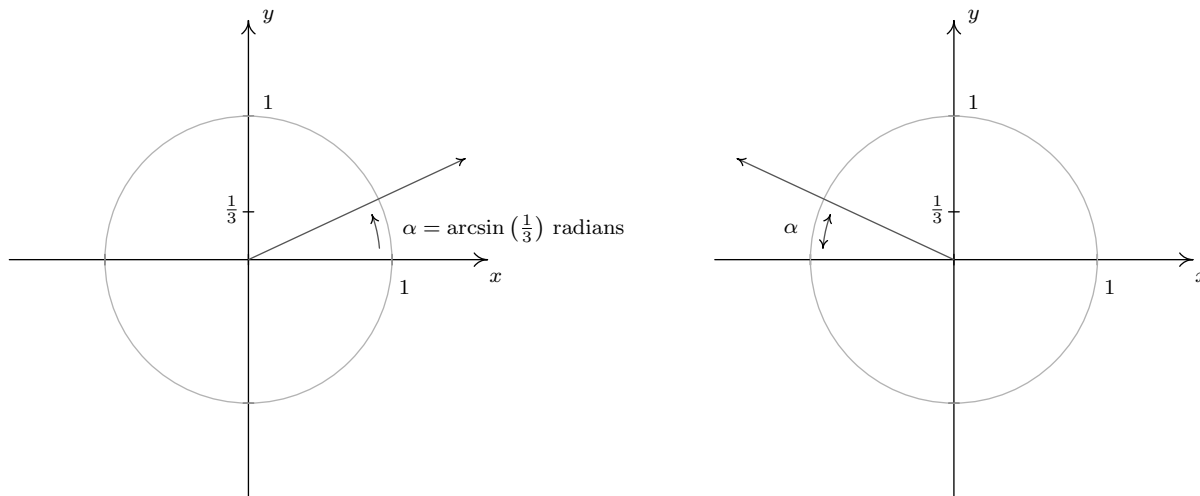

Since $\frac{1}{3}$ isn't the sine of any of the 'common angles' discussed earlier, we use the arcsine functions to express our answers. The real number $t = \arcsin(\frac{1}{3})$ is defined so it satisfies $0 < t < \frac{\pi}{2}$ with $\sin(t) = \frac{1}{3}$. Hence, $\alpha = \arcsin(\frac{1}{3})$ radians. Since the solutions in Quadrant I are all coterminal with α , we get part of our solution to be $\theta = \alpha + 2\pi k = \arcsin(\frac{1}{3}) + 2\pi k$ for integers k . Turning our attention to Quadrant II, we get one solution to be $\pi - \alpha$. Hence, the Quadrant II solutions are $\theta = \pi - \alpha + 2\pi k = \pi - \arcsin(\frac{1}{3}) + 2\pi k$, for integers k .

2. We may visualize the solutions to $\tan(t) = -2$ as angles θ with $\tan(\theta) = -2$. Since tangent is negative only in Quadrants II and IV, we focus our efforts there.

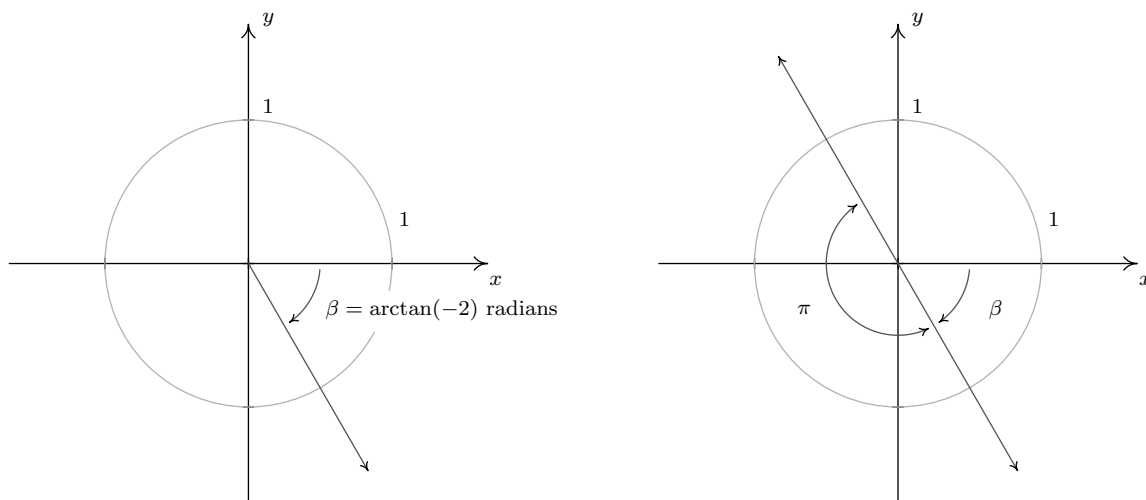

Since -2 isn't the tangent of any of the 'common angles', we need to use the arctangent function to express our answers. The real number $t = \arctan(-2)$ satisfies $\tan(t) = -2$ and $-\frac{\pi}{2} < t < 0$. If we let $\beta = \arctan(-2)$ radians, we see that all of the Quadrant IV solutions

to $\tan(\theta) = -2$ are coterminal with β . Moreover, the solutions from Quadrant II differ by exactly π units from the solutions in Quadrant IV, so all the solutions to $\tan(\theta) = -2$ are of the form $\theta = \beta + \pi k = \arctan(-2) + \pi k$ for some integer k . Switching back to the variable t , we record our final answer to $\tan(t) = -2$ as $t = \arctan(-2) + \pi k$ for integers k .

3. The last equation we are asked to solve, $\sec(x) = -\frac{5}{3}$, poses two immediate problems. First, we are not told whether or not x represents an angle or a real number. We assume the latter, but note that we will use angles and the Unit Circle to solve the equation regardless. Second, as we have mentioned, there is no universally accepted range of the arcsecant function. For that reason, we adopt the advice given in Section 8.3 and convert this to the cosine problem $\cos(x) = -\frac{3}{5}$. Adopting an angle approach, we consider the equation $\cos(\theta) = -\frac{3}{5}$ and note that our solutions lie in Quadrants II and III. Since $-\frac{3}{5}$ isn't the cosine of any of the 'common angles', we'll need to express our solutions in terms of the arccosine function. The real number $t = \arccos(-\frac{3}{5})$ is defined so that $\frac{\pi}{2} < t < \pi$ with $\cos(t) = -\frac{3}{5}$. If we let $\beta = \arccos(-\frac{3}{5})$ radians, we see that β is a Quadrant II angle. To obtain a Quadrant III angle solution, we may simply use $-\beta = -\arccos(-\frac{3}{5})$. Since all angle solutions are coterminal with β or $-\beta$, we get our solutions to $\cos(\theta) = -\frac{3}{5}$ to be $\theta = \beta + 2\pi k = \arccos(-\frac{3}{5}) + 2\pi k$ or $\theta = -\beta + 2\pi k = -\arccos(-\frac{3}{5}) + 2\pi k$ for integers k . Switching back to the variable x , we record our final answer to $\sec(x) = -\frac{5}{3}$ as $x = \arccos(-\frac{3}{5}) + 2\pi k$ or $x = -\arccos(-\frac{3}{5}) + 2\pi k$ for integers k .

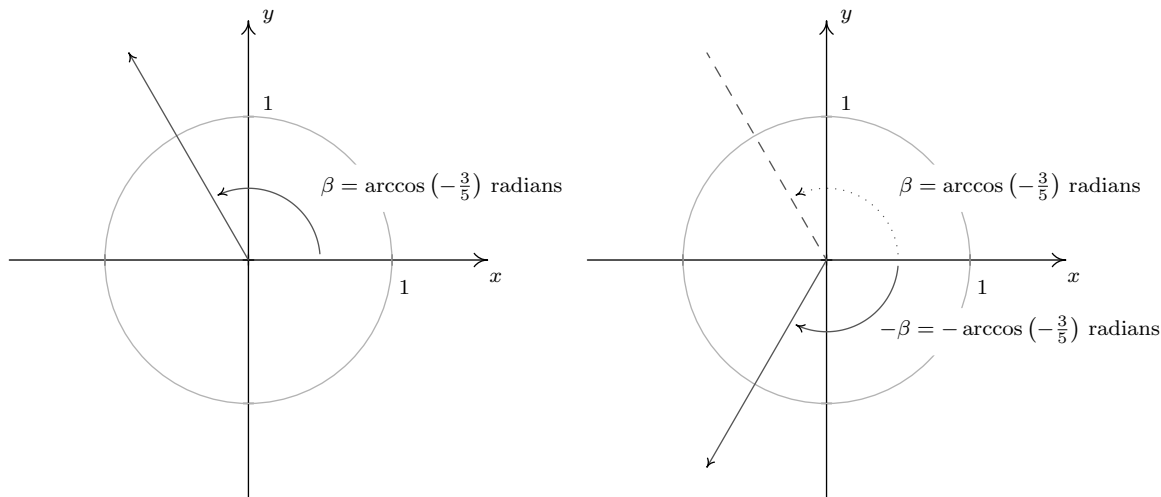

□

The reader is encouraged to check the answers found in Example 8.6.7 - both analytically and with the calculator (see Section 8.6.3). With practice, the inverse trigonometric functions will become as familiar to you as the square root function. Speaking of practice ...

8.6.5 EXERCISES

In Exercises 1 - 40, find the exact value.

- | | | | |
|---|---|---|---|
| 1. $\arcsin(-1)$ | 2. $\arcsin\left(-\frac{\sqrt{3}}{2}\right)$ | 3. $\arcsin\left(-\frac{\sqrt{2}}{2}\right)$ | 4. $\arcsin\left(-\frac{1}{2}\right)$ |
| 5. $\arcsin(0)$ | 6. $\arcsin\left(\frac{1}{2}\right)$ | 7. $\arcsin\left(\frac{\sqrt{2}}{2}\right)$ | 8. $\arcsin\left(\frac{\sqrt{3}}{2}\right)$ |
| 9. $\arcsin(1)$ | 10. $\arccos(-1)$ | 11. $\arccos\left(-\frac{\sqrt{3}}{2}\right)$ | 12. $\arccos\left(-\frac{\sqrt{2}}{2}\right)$ |
| 13. $\arccos\left(-\frac{1}{2}\right)$ | 14. $\arccos(0)$ | 15. $\arccos\left(\frac{1}{2}\right)$ | 16. $\arccos\left(\frac{\sqrt{2}}{2}\right)$ |
| 17. $\arccos\left(\frac{\sqrt{3}}{2}\right)$ | 18. $\arccos(1)$ | 19. $\arctan(-\sqrt{3})$ | 20. $\arctan(-1)$ |
| 21. $\arctan\left(-\frac{\sqrt{3}}{3}\right)$ | 22. $\arctan(0)$ | 23. $\arctan\left(\frac{\sqrt{3}}{3}\right)$ | 24. $\arctan(1)$ |
| 25. $\arctan(\sqrt{3})$ | 26. $\operatorname{arccot}(-\sqrt{3})$ | 27. $\operatorname{arccot}(-1)$ | 28. $\operatorname{arccot}\left(-\frac{\sqrt{3}}{3}\right)$ |
| 29. $\operatorname{arccot}(0)$ | 30. $\operatorname{arccot}\left(\frac{\sqrt{3}}{3}\right)$ | 31. $\operatorname{arccot}(1)$ | 32. $\operatorname{arccot}(\sqrt{3})$ |
| 33. $\operatorname{arcsec}(2)$ | 34. $\operatorname{arccsc}(2)$ | 35. $\operatorname{arcsec}(\sqrt{2})$ | 36. $\operatorname{arccsc}(\sqrt{2})$ |
| 37. $\operatorname{arcsec}\left(\frac{2\sqrt{3}}{3}\right)$ | 38. $\operatorname{arccsc}\left(\frac{2\sqrt{3}}{3}\right)$ | 39. $\operatorname{arcsec}(1)$ | 40. $\operatorname{arccsc}(1)$ |

In Exercises 41 - 48, assume that the range of arcsecant is $[0, \frac{\pi}{2}) \cup [\pi, \frac{3\pi}{2})$ and that the range of arccosecant is $(0, \frac{\pi}{2}] \cup (\pi, \frac{3\pi}{2}]$ when finding the exact value.

- | | | | |
|---------------------------------|--|--|---------------------------------|
| 41. $\operatorname{arcsec}(-2)$ | 42. $\operatorname{arcsec}(-\sqrt{2})$ | 43. $\operatorname{arcsec}\left(-\frac{2\sqrt{3}}{3}\right)$ | 44. $\operatorname{arcsec}(-1)$ |
| 45. $\operatorname{arccsc}(-2)$ | 46. $\operatorname{arccsc}(-\sqrt{2})$ | 47. $\operatorname{arccsc}\left(-\frac{2\sqrt{3}}{3}\right)$ | 48. $\operatorname{arccsc}(-1)$ |

In Exercises 49 - 56, assume that the range of arcsecant is $[0, \frac{\pi}{2}) \cup (\frac{\pi}{2}, \pi]$ and that the range of arccosecant is $[-\frac{\pi}{2}, 0) \cup (0, \frac{\pi}{2}]$ when finding the exact value.

$$\begin{array}{llll}
 49. \operatorname{arcsec}(-2) & 50. \operatorname{arcsec}(-\sqrt{2}) & 51. \operatorname{arcsec}\left(-\frac{2\sqrt{3}}{3}\right) & 52. \operatorname{arcsec}(-1) \\
 53. \operatorname{arccsc}(-2) & 54. \operatorname{arccsc}(-\sqrt{2}) & 55. \operatorname{arccsc}\left(-\frac{2\sqrt{3}}{3}\right) & 56. \operatorname{arccsc}(-1)
 \end{array}$$

In Exercises 57 - 86, find the exact value or state that it is undefined.

$$\begin{array}{lll}
 57. \sin\left(\arcsin\left(\frac{1}{2}\right)\right) & 58. \sin\left(\arcsin\left(-\frac{\sqrt{2}}{2}\right)\right) & 59. \sin\left(\arcsin\left(\frac{3}{5}\right)\right) \\
 60. \sin(\arcsin(-0.42)) & 61. \sin\left(\arcsin\left(\frac{5}{4}\right)\right) & 62. \cos\left(\arccos\left(\frac{\sqrt{2}}{2}\right)\right) \\
 63. \cos\left(\arccos\left(-\frac{1}{2}\right)\right) & 64. \cos\left(\arccos\left(\frac{5}{13}\right)\right) & 65. \cos(\arccos(-0.998)) \\
 66. \cos(\arccos(\pi)) & 67. \tan(\arctan(-1)) & 68. \tan(\arctan(\sqrt{3})) \\
 69. \tan\left(\arctan\left(\frac{5}{12}\right)\right) & 70. \tan(\arctan(0.965)) & 71. \tan(\arctan(3\pi)) \\
 72. \cot(\operatorname{arccot}(1)) & 73. \cot(\operatorname{arccot}(-\sqrt{3})) & 74. \cot\left(\operatorname{arccot}\left(-\frac{7}{24}\right)\right) \\
 75. \cot(\operatorname{arccot}(-0.001)) & 76. \cot\left(\operatorname{arccot}\left(\frac{17\pi}{4}\right)\right) & 77. \sec(\operatorname{arcsec}(2)) \\
 78. \sec(\operatorname{arcsec}(-1)) & 79. \sec\left(\operatorname{arcsec}\left(\frac{1}{2}\right)\right) & 80. \sec(\operatorname{arcsec}(0.75)) \\
 81. \sec(\operatorname{arcsec}(117\pi)) & 82. \csc(\operatorname{arccsc}(\sqrt{2})) & 83. \csc\left(\operatorname{arccsc}\left(-\frac{2\sqrt{3}}{3}\right)\right) \\
 84. \csc\left(\operatorname{arccsc}\left(\frac{\sqrt{2}}{2}\right)\right) & 85. \csc(\operatorname{arccsc}(1.0001)) & 86. \csc\left(\operatorname{arccsc}\left(\frac{\pi}{4}\right)\right)
 \end{array}$$

In Exercises 87 - 106, find the exact value or state that it is undefined.

$$\begin{array}{lll}
 87. \arcsin\left(\sin\left(\frac{\pi}{6}\right)\right) & 88. \arcsin\left(\sin\left(-\frac{\pi}{3}\right)\right) & 89. \arcsin\left(\sin\left(\frac{3\pi}{4}\right)\right)
 \end{array}$$

90. $\arcsin\left(\sin\left(\frac{11\pi}{6}\right)\right)$

91. $\arcsin\left(\sin\left(\frac{4\pi}{3}\right)\right)$

92. $\arccos\left(\cos\left(\frac{\pi}{4}\right)\right)$

93. $\arccos\left(\cos\left(\frac{2\pi}{3}\right)\right)$

94. $\arccos\left(\cos\left(\frac{3\pi}{2}\right)\right)$

95. $\arccos\left(\cos\left(-\frac{\pi}{6}\right)\right)$

96. $\arccos\left(\cos\left(\frac{5\pi}{4}\right)\right)$

97. $\arctan\left(\tan\left(\frac{\pi}{3}\right)\right)$

98. $\arctan\left(\tan\left(-\frac{\pi}{4}\right)\right)$

99. $\arctan(\tan(\pi))$

100. $\arctan\left(\tan\left(\frac{\pi}{2}\right)\right)$

101. $\arctan\left(\tan\left(\frac{2\pi}{3}\right)\right)$

102. $\operatorname{arccot}\left(\cot\left(\frac{\pi}{3}\right)\right)$

103. $\operatorname{arccot}\left(\cot\left(-\frac{\pi}{4}\right)\right)$

104. $\operatorname{arccot}(\cot(\pi))$

105. $\operatorname{arccot}\left(\cot\left(\frac{\pi}{2}\right)\right)$

106. $\operatorname{arccot}\left(\cot\left(\frac{2\pi}{3}\right)\right)$

In Exercises 107 - 118, assume that the range of arcsecant is $[0, \frac{\pi}{2}) \cup [\pi, \frac{3\pi}{2})$ and that the range of arccosecant is $(0, \frac{\pi}{2}] \cup (\pi, \frac{3\pi}{2}]$ when finding the exact value.

107. $\operatorname{arcsec}\left(\sec\left(\frac{\pi}{4}\right)\right)$

108. $\operatorname{arcsec}\left(\sec\left(\frac{4\pi}{3}\right)\right)$

109. $\operatorname{arcsec}\left(\sec\left(\frac{5\pi}{6}\right)\right)$

110. $\operatorname{arcsec}\left(\sec\left(-\frac{\pi}{2}\right)\right)$

111. $\operatorname{arcsec}\left(\sec\left(\frac{5\pi}{3}\right)\right)$

112. $\operatorname{arccsc}\left(\csc\left(\frac{\pi}{6}\right)\right)$

113. $\operatorname{arccsc}\left(\csc\left(\frac{5\pi}{4}\right)\right)$

114. $\operatorname{arccsc}\left(\csc\left(\frac{2\pi}{3}\right)\right)$

115. $\operatorname{arccsc}\left(\csc\left(-\frac{\pi}{2}\right)\right)$

116. $\operatorname{arccsc}\left(\csc\left(\frac{11\pi}{6}\right)\right)$

117. $\operatorname{arcsec}\left(\sec\left(\frac{11\pi}{12}\right)\right)$

118. $\operatorname{arccsc}\left(\csc\left(\frac{9\pi}{8}\right)\right)$

In Exercises 119 - 130, assume that the range of arcsecant is $[0, \frac{\pi}{2}) \cup (\frac{\pi}{2}, \pi]$ and that the range of arccosecant is $[-\frac{\pi}{2}, 0) \cup (0, \frac{\pi}{2}]$ when finding the exact value.

119. $\operatorname{arcsec}\left(\sec\left(\frac{\pi}{4}\right)\right)$

120. $\operatorname{arcsec}\left(\sec\left(\frac{4\pi}{3}\right)\right)$

121. $\operatorname{arcsec}\left(\sec\left(\frac{5\pi}{6}\right)\right)$

122. $\operatorname{arcsec}\left(\sec\left(-\frac{\pi}{2}\right)\right)$

123. $\operatorname{arcsec}\left(\sec\left(\frac{5\pi}{3}\right)\right)$

124. $\operatorname{arccsc}\left(\csc\left(\frac{\pi}{6}\right)\right)$

125. $\operatorname{arccsc}\left(\csc\left(\frac{5\pi}{4}\right)\right)$

126. $\operatorname{arccsc}\left(\csc\left(\frac{2\pi}{3}\right)\right)$

127. $\operatorname{arccsc}\left(\csc\left(-\frac{\pi}{2}\right)\right)$

128. $\operatorname{arccsc}\left(\csc\left(\frac{11\pi}{6}\right)\right)$

129. $\operatorname{arcsec}\left(\sec\left(\frac{11\pi}{12}\right)\right)$

130. $\operatorname{arccsc}\left(\csc\left(\frac{9\pi}{8}\right)\right)$

In Exercises 131 - 154, find the exact value or state that it is undefined.

- | | | |
|--|---|---|
| 131. $\sin\left(\arccos\left(-\frac{1}{2}\right)\right)$ | 132. $\sin\left(\arccos\left(\frac{3}{5}\right)\right)$ | 133. $\sin(\arctan(-2))$ |
| 134. $\sin(\operatorname{arccot}(\sqrt{5}))$ | 135. $\sin(\operatorname{arccsc}(-3))$ | 136. $\cos\left(\arcsin\left(-\frac{5}{13}\right)\right)$ |
| 137. $\cos(\arctan(\sqrt{7}))$ | 138. $\cos(\operatorname{arccot}(3))$ | 139. $\cos(\operatorname{arcsec}(5))$ |
| 140. $\tan\left(\arcsin\left(-\frac{2\sqrt{5}}{5}\right)\right)$ | 141. $\tan\left(\arccos\left(-\frac{1}{2}\right)\right)$ | 142. $\tan\left(\operatorname{arcsec}\left(\frac{5}{3}\right)\right)$ |
| 143. $\tan(\operatorname{arccot}(12))$ | 144. $\cot\left(\arcsin\left(\frac{12}{13}\right)\right)$ | 145. $\cot\left(\arccos\left(\frac{\sqrt{3}}{2}\right)\right)$ |
| 146. $\cot(\operatorname{arccsc}(\sqrt{5}))$ | 147. $\cot(\arctan(0.25))$ | 148. $\sec\left(\arccos\left(\frac{\sqrt{3}}{2}\right)\right)$ |
| 149. $\sec\left(\arcsin\left(-\frac{12}{13}\right)\right)$ | 150. $\sec(\arctan(10))$ | 151. $\sec\left(\operatorname{arccot}\left(-\frac{\sqrt{10}}{10}\right)\right)$ |
| 152. $\csc(\operatorname{arccot}(9))$ | 153. $\csc\left(\arcsin\left(\frac{3}{5}\right)\right)$ | 154. $\csc\left(\arctan\left(-\frac{2}{3}\right)\right)$ |

In Exercises 155 - 164, find the exact value or state that it is undefined.

- | | |
|--|---|
| 155. $\sin\left(\arcsin\left(\frac{5}{13}\right) + \frac{\pi}{4}\right)$ | 156. $\cos(\operatorname{arcsec}(3) + \arctan(2))$ |
| 157. $\tan\left(\arctan(3) + \arccos\left(-\frac{3}{5}\right)\right)$ | 158. $\sin\left(2\arcsin\left(-\frac{4}{5}\right)\right)$ |
| 159. $\sin\left(2\operatorname{arccsc}\left(\frac{13}{5}\right)\right)$ | 160. $\sin(2\arctan(2))$ |
| 161. $\cos\left(2\arcsin\left(\frac{3}{5}\right)\right)$ | 162. $\cos\left(2\operatorname{arcsec}\left(\frac{25}{7}\right)\right)$ |
| 163. $\cos(2\operatorname{arccot}(-\sqrt{5}))$ | 164. $\sin\left(\frac{\arctan(2)}{2}\right)$ |

In Exercises 165 - 184, rewrite the quantity as algebraic expressions of x and state the domain on which the equivalence is valid.

- | | | |
|--|--|--------------------------|
| 165. $\sin(\arccos(x))$ | 166. $\cos(\arctan(x))$ | 167. $\tan(\arcsin(x))$ |
| 168. $\sec(\arctan(x))$ | 169. $\csc(\arccos(x))$ | 170. $\sin(2\arctan(x))$ |
| 171. $\sin(2\arccos(x))$ | 172. $\cos(2\arctan(x))$ | 173. $\sin(\arccos(2x))$ |
| 174. $\sin\left(\arccos\left(\frac{x}{5}\right)\right)$ | 175. $\cos\left(\arcsin\left(\frac{x}{2}\right)\right)$ | 176. $\cos(\arctan(3x))$ |
| 177. $\sin(2\arcsin(7x))$ | 178. $\sin\left(2\arcsin\left(\frac{x\sqrt{3}}{3}\right)\right)$ | |
| 179. $\cos(2\arcsin(4x))$ | 180. $\sec(\arctan(2x))\tan(\arctan(2x))$ | |
| 181. $\sin(\arcsin(x) + \arccos(x))$ | 182. $\cos(\arcsin(x) + \arctan(x))$ | |
| 183. $\tan(2\arcsin(x))$ | 184. $\sin\left(\frac{1}{2}\arctan(x)\right)$ | |
| 185. If $\sin(\theta) = \frac{x}{2}$ for $-\frac{\pi}{2} < \theta < \frac{\pi}{2}$, find an expression for $\theta + \sin(2\theta)$ in terms of x . | | |
| 186. If $\tan(\theta) = \frac{x}{7}$ for $-\frac{\pi}{2} < \theta < \frac{\pi}{2}$, find an expression for $\frac{1}{2}\theta - \frac{1}{2}\sin(2\theta)$ in terms of x . | | |
| 187. If $\sec(\theta) = \frac{x}{4}$ for $0 < \theta < \frac{\pi}{2}$, find an expression for $4\tan(\theta) - 4\theta$ in terms of x . | | |

In Exercises 188 - 207, solve the equation using the techniques discussed in Example 8.6.7 then approximate the solutions which lie in the interval $[0, 2\pi)$ to four decimal places.

- | | | |
|---------------------------------|-------------------------------|----------------------------------|
| 188. $\sin(x) = \frac{7}{11}$ | 189. $\cos(x) = -\frac{2}{9}$ | 190. $\sin(x) = -0.569$ |
| 191. $\cos(x) = 0.117$ | 192. $\sin(x) = 0.008$ | 193. $\cos(x) = \frac{359}{360}$ |
| 194. $\tan(x) = 117$ | 195. $\cot(x) = -12$ | 196. $\sec(x) = \frac{3}{2}$ |
| 197. $\csc(x) = -\frac{90}{17}$ | 198. $\tan(x) = -\sqrt{10}$ | 199. $\sin(x) = \frac{3}{8}$ |
| 200. $\cos(x) = -\frac{7}{16}$ | 201. $\tan(x) = 0.03$ | 202. $\sin(x) = 0.3502$ |

203. $\sin(x) = -0.721$

204. $\cos(x) = 0.9824$

205. $\cos(x) = -0.5637$

206. $\cot(x) = \frac{1}{117}$

207. $\tan(x) = -0.6109$

In Exercises 208 - 210, find the two acute angles in the right triangle whose sides have the given lengths. Express your answers using degree measure rounded to two decimal places.

208. 3, 4 and 5

209. 5, 12 and 13

210. 336, 527 and 625

211. A guy wire 1000 feet long is attached to the top of a tower. When pulled taut it touches level ground 360 feet from the base of the tower. What angle does the wire make with the ground? Express your answer using degree measure rounded to one decimal place.

212. At Cliffs of Insanity Point, The Great Sasquatch Canyon is 7117 feet deep. From that point, a fire is seen at a location known to be 10 miles away from the base of the sheer canyon wall. What angle of depression is made by the line of sight from the canyon edge to the fire? Express your answer using degree measure rounded to one decimal place.

213. Shelving is being built at the Utility Muffin Research Library which is to be 14 inches deep. An 18-inch rod will be attached to the wall and the underside of the shelf at its edge away from the wall, forming a right triangle under the shelf to support it. What angle, to the nearest degree, will the rod make with the wall?

214. A parasailor is being pulled by a boat on Lake Ippizuti. The cable is 300 feet long and the parasailor is 100 feet above the surface of the water. What is the angle of elevation from the boat to the parasailor? Express your answer using degree measure rounded to one decimal place.

215. A tag-and-release program to study the Sasquatch population of the eponymous Sasquatch National Park is begun. From a 200 foot tall tower, a ranger spots a Sasquatch lumbering through the wilderness directly towards the tower. Let θ denote the angle of depression from the top of the tower to a point on the ground. If the range of the rifle with a tranquilizer dart is 300 feet, find the smallest value of θ for which the corresponding point on the ground is in range of the rifle. Round your answer to the nearest hundredth of a degree.

In Exercises 216 - 221, rewrite the given function as a sinusoid of the form $S(x) = A \sin(\omega x + \phi)$ using Exercises 35 and 36 in Section 8.5 for reference. Approximate the value of ϕ (which is in radians, of course) to four decimal places.

216. $f(x) = 5 \sin(3x) + 12 \cos(3x)$

217. $f(x) = 3 \cos(2x) + 4 \sin(2x)$

218. $f(x) = \cos(x) - 3 \sin(x)$

219. $f(x) = 7 \sin(10x) - 24 \cos(10x)$

220. $f(x) = -\cos(x) - 2\sqrt{2}\sin(x)$

221. $f(x) = 2\sin(x) - \cos(x)$

In Exercises 222 - 233, find the domain of the given function. Write your answers in interval notation.

222. $f(x) = \arcsin(5x)$

223. $f(x) = \arccos\left(\frac{3x-1}{2}\right)$

224. $f(x) = \arcsin(2x^2)$

225. $f(x) = \arccos\left(\frac{1}{x^2-4}\right)$

226. $f(x) = \arctan(4x)$

227. $f(x) = \operatorname{arccot}\left(\frac{2x}{x^2-9}\right)$

228. $f(x) = \arctan(\ln(2x-1))$

229. $f(x) = \operatorname{arccot}(\sqrt{2x-1})$

230. $f(x) = \operatorname{arcsec}(12x)$

231. $f(x) = \operatorname{arccsc}(x+5)$

232. $f(x) = \operatorname{arcsec}\left(\frac{x^3}{8}\right)$

233. $f(x) = \operatorname{arccsc}(e^{2x})$

234. Show that $\operatorname{arcsec}(x) = \arccos\left(\frac{1}{x}\right)$ for $|x| \geq 1$ as long as we use $\left[0, \frac{\pi}{2}\right] \cup \left(\frac{\pi}{2}, \pi\right]$ as the range of $f(x) = \operatorname{arcsec}(x)$.

235. Show that $\operatorname{arccsc}(x) = \arcsin\left(\frac{1}{x}\right)$ for $|x| \geq 1$ as long as we use $\left[-\frac{\pi}{2}, 0\right) \cup \left(0, \frac{\pi}{2}\right]$ as the range of $f(x) = \operatorname{arccsc}(x)$.

236. Show that $\arcsin(x) + \arccos(x) = \frac{\pi}{2}$ for $-1 \leq x \leq 1$.

237. Discuss with your classmates why $\arcsin\left(\frac{1}{2}\right) \neq 30^\circ$.

238. Use the following picture and the series of exercises on the next page to show that

$$\arctan(1) + \arctan(2) + \arctan(3) = \pi$$

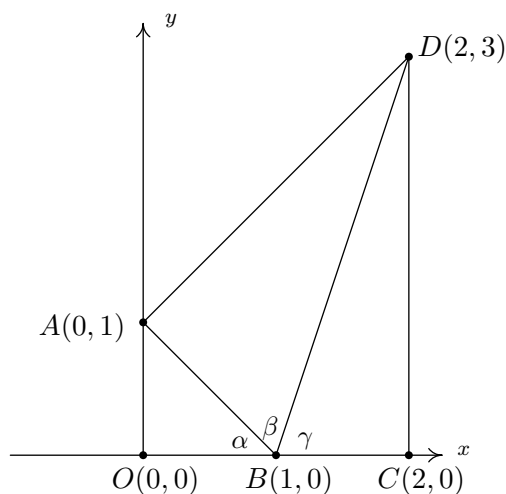

- (a) Clearly $\triangle AOB$ and $\triangle BCD$ are right triangles because the line through O and A and the line through C and D are perpendicular to the x -axis. Use the distance formula to show that $\triangle BAD$ is also a right triangle (with $\angle BAD$ being the right angle) by showing that the sides of the triangle satisfy the Pythagorean Theorem.
- (b) Use $\triangle AOB$ to show that $\alpha = \arctan(1)$
- (c) Use $\triangle BAD$ to show that $\beta = \arctan(2)$
- (d) Use $\triangle BCD$ to show that $\gamma = \arctan(3)$
- (e) Use the fact that O , B and C all lie on the x -axis to conclude that $\alpha + \beta + \gamma = \pi$. Thus $\arctan(1) + \arctan(2) + \arctan(3) = \pi$.

8.6.6 ANSWERS

1. $\arcsin(-1) = -\frac{\pi}{2}$
2. $\arcsin\left(-\frac{\sqrt{3}}{2}\right) = -\frac{\pi}{3}$
3. $\arcsin\left(-\frac{\sqrt{2}}{2}\right) = -\frac{\pi}{4}$
4. $\arcsin\left(-\frac{1}{2}\right) = -\frac{\pi}{6}$
5. $\arcsin(0) = 0$
6. $\arcsin\left(\frac{1}{2}\right) = \frac{\pi}{6}$
7. $\arcsin\left(\frac{\sqrt{2}}{2}\right) = \frac{\pi}{4}$
8. $\arcsin\left(\frac{\sqrt{3}}{2}\right) = \frac{\pi}{3}$
9. $\arcsin(1) = \frac{\pi}{2}$
10. $\arccos(-1) = \pi$
11. $\arccos\left(-\frac{\sqrt{3}}{2}\right) = \frac{5\pi}{6}$
12. $\arccos\left(-\frac{\sqrt{2}}{2}\right) = \frac{3\pi}{4}$
13. $\arccos\left(-\frac{1}{2}\right) = \frac{2\pi}{3}$
14. $\arccos(0) = \frac{\pi}{2}$
15. $\arccos\left(\frac{1}{2}\right) = \frac{\pi}{3}$
16. $\arccos\left(\frac{\sqrt{2}}{2}\right) = \frac{\pi}{4}$
17. $\arccos\left(\frac{\sqrt{3}}{2}\right) = \frac{\pi}{6}$
18. $\arccos(1) = 0$
19. $\arctan(-\sqrt{3}) = -\frac{\pi}{3}$
20. $\arctan(-1) = -\frac{\pi}{4}$
21. $\arctan\left(-\frac{\sqrt{3}}{3}\right) = -\frac{\pi}{6}$
22. $\arctan(0) = 0$
23. $\arctan\left(\frac{\sqrt{3}}{3}\right) = \frac{\pi}{6}$
24. $\arctan(1) = \frac{\pi}{4}$
25. $\arctan(\sqrt{3}) = \frac{\pi}{3}$
26. $\operatorname{arccot}(-\sqrt{3}) = \frac{5\pi}{6}$
27. $\operatorname{arccot}(-1) = \frac{3\pi}{4}$
28. $\operatorname{arccot}\left(-\frac{\sqrt{3}}{3}\right) = \frac{2\pi}{3}$
29. $\operatorname{arccot}(0) = \frac{\pi}{2}$
30. $\operatorname{arccot}\left(\frac{\sqrt{3}}{3}\right) = \frac{\pi}{3}$
31. $\operatorname{arccot}(1) = \frac{\pi}{4}$
32. $\operatorname{arccot}(\sqrt{3}) = \frac{\pi}{6}$
33. $\operatorname{arcsec}(2) = \frac{\pi}{3}$
34. $\operatorname{arcsec}(2) = \frac{\pi}{6}$
35. $\operatorname{arcsec}(\sqrt{2}) = \frac{\pi}{4}$
36. $\operatorname{arcsec}(\sqrt{2}) = \frac{\pi}{4}$
37. $\operatorname{arcsec}\left(\frac{2\sqrt{3}}{3}\right) = \frac{\pi}{6}$
38. $\operatorname{arcsec}\left(\frac{2\sqrt{3}}{3}\right) = \frac{\pi}{3}$
39. $\operatorname{arcsec}(1) = 0$
40. $\operatorname{arcsec}(1) = \frac{\pi}{2}$
41. $\operatorname{arcsec}(-2) = \frac{4\pi}{3}$
42. $\operatorname{arcsec}(-\sqrt{2}) = \frac{5\pi}{4}$

43. $\operatorname{arcsec}\left(-\frac{2\sqrt{3}}{3}\right) = \frac{7\pi}{6}$ 44. $\operatorname{arcsec}(-1) = \pi$ 45. $\operatorname{arccsc}(-2) = \frac{7\pi}{6}$
46. $\operatorname{arccsc}(-\sqrt{2}) = \frac{5\pi}{4}$ 47. $\operatorname{arccsc}\left(-\frac{2\sqrt{3}}{3}\right) = \frac{4\pi}{3}$ 48. $\operatorname{arccsc}(-1) = \frac{3\pi}{2}$
49. $\operatorname{arcsec}(-2) = \frac{2\pi}{3}$ 50. $\operatorname{arcsec}(-\sqrt{2}) = \frac{3\pi}{4}$ 51. $\operatorname{arcsec}\left(-\frac{2\sqrt{3}}{3}\right) = \frac{5\pi}{6}$
52. $\operatorname{arcsec}(-1) = \pi$ 53. $\operatorname{arccsc}(-2) = -\frac{\pi}{6}$ 54. $\operatorname{arccsc}(-\sqrt{2}) = -\frac{\pi}{4}$
55. $\operatorname{arccsc}\left(-\frac{2\sqrt{3}}{3}\right) = -\frac{\pi}{3}$ 56. $\operatorname{arccsc}(-1) = -\frac{\pi}{2}$
57. $\sin\left(\arcsin\left(\frac{1}{2}\right)\right) = \frac{1}{2}$ 58. $\sin\left(\arcsin\left(-\frac{\sqrt{2}}{2}\right)\right) = -\frac{\sqrt{2}}{2}$
59. $\sin\left(\arcsin\left(\frac{3}{5}\right)\right) = \frac{3}{5}$ 60. $\sin(\arcsin(-0.42)) = -0.42$
61. $\sin\left(\arcsin\left(\frac{5}{4}\right)\right)$ is undefined. 62. $\cos\left(\arccos\left(\frac{\sqrt{2}}{2}\right)\right) = \frac{\sqrt{2}}{2}$
63. $\cos\left(\arccos\left(-\frac{1}{2}\right)\right) = -\frac{1}{2}$ 64. $\cos\left(\arccos\left(\frac{5}{13}\right)\right) = \frac{5}{13}$
65. $\cos(\arccos(-0.998)) = -0.998$ 66. $\cos(\arccos(\pi))$ is undefined.
67. $\tan(\arctan(-1)) = -1$ 68. $\tan(\arctan(\sqrt{3})) = \sqrt{3}$
69. $\tan\left(\arctan\left(\frac{5}{12}\right)\right) = \frac{5}{12}$ 70. $\tan(\arctan(0.965)) = 0.965$
71. $\tan(\arctan(3\pi)) = 3\pi$ 72. $\cot(\operatorname{arccot}(1)) = 1$
73. $\cot(\operatorname{arccot}(-\sqrt{3})) = -\sqrt{3}$ 74. $\cot\left(\operatorname{arccot}\left(-\frac{7}{24}\right)\right) = -\frac{7}{24}$
75. $\cot(\operatorname{arccot}(-0.001)) = -0.001$ 76. $\cot\left(\operatorname{arccot}\left(\frac{17\pi}{4}\right)\right) = \frac{17\pi}{4}$
77. $\sec(\operatorname{arcsec}(2)) = 2$ 78. $\sec(\operatorname{arcsec}(-1)) = -1$

79. $\sec\left(\operatorname{arcsec}\left(\frac{1}{2}\right)\right)$ is undefined.
80. $\sec(\operatorname{arcsec}(0.75))$ is undefined.
81. $\sec(\operatorname{arcsec}(117\pi)) = 117\pi$
82. $\csc(\operatorname{arccsc}(\sqrt{2})) = \sqrt{2}$
83. $\csc\left(\operatorname{arccsc}\left(-\frac{2\sqrt{3}}{3}\right)\right) = -\frac{2\sqrt{3}}{3}$
84. $\csc\left(\operatorname{arccsc}\left(\frac{\sqrt{2}}{2}\right)\right)$ is undefined.
85. $\csc(\operatorname{arccsc}(1.0001)) = 1.0001$
86. $\csc\left(\operatorname{arccsc}\left(\frac{\pi}{4}\right)\right)$ is undefined.
87. $\arcsin\left(\sin\left(\frac{\pi}{6}\right)\right) = \frac{\pi}{6}$
88. $\arcsin\left(\sin\left(-\frac{\pi}{3}\right)\right) = -\frac{\pi}{3}$
89. $\arcsin\left(\sin\left(\frac{3\pi}{4}\right)\right) = \frac{\pi}{4}$
90. $\arcsin\left(\sin\left(\frac{11\pi}{6}\right)\right) = -\frac{\pi}{6}$
91. $\arcsin\left(\sin\left(\frac{4\pi}{3}\right)\right) = -\frac{\pi}{3}$
92. $\arccos\left(\cos\left(\frac{\pi}{4}\right)\right) = \frac{\pi}{4}$
93. $\arccos\left(\cos\left(\frac{2\pi}{3}\right)\right) = \frac{2\pi}{3}$
94. $\arccos\left(\cos\left(\frac{3\pi}{2}\right)\right) = \frac{\pi}{2}$
95. $\arccos\left(\cos\left(-\frac{\pi}{6}\right)\right) = \frac{\pi}{6}$
96. $\arccos\left(\cos\left(\frac{5\pi}{4}\right)\right) = \frac{3\pi}{4}$
97. $\arctan\left(\tan\left(\frac{\pi}{3}\right)\right) = \frac{\pi}{3}$
98. $\arctan\left(\tan\left(-\frac{\pi}{4}\right)\right) = -\frac{\pi}{4}$
99. $\arctan(\tan(\pi)) = 0$
100. $\arctan\left(\tan\left(\frac{\pi}{2}\right)\right)$ is undefined
101. $\arctan\left(\tan\left(\frac{2\pi}{3}\right)\right) = -\frac{\pi}{3}$
102. $\operatorname{arccot}\left(\cot\left(\frac{\pi}{3}\right)\right) = \frac{\pi}{3}$
103. $\operatorname{arccot}\left(\cot\left(-\frac{\pi}{4}\right)\right) = \frac{3\pi}{4}$
104. $\operatorname{arccot}(\cot(\pi))$ is undefined
105. $\operatorname{arccot}\left(\cot\left(\frac{3\pi}{2}\right)\right) = \frac{\pi}{2}$
106. $\operatorname{arccot}\left(\cot\left(\frac{2\pi}{3}\right)\right) = \frac{2\pi}{3}$
107. $\operatorname{arcsec}\left(\sec\left(\frac{\pi}{4}\right)\right) = \frac{\pi}{4}$
108. $\operatorname{arcsec}\left(\sec\left(\frac{4\pi}{3}\right)\right) = \frac{4\pi}{3}$
109. $\operatorname{arcsec}\left(\sec\left(\frac{5\pi}{6}\right)\right) = \frac{7\pi}{6}$
110. $\operatorname{arcsec}\left(\sec\left(-\frac{\pi}{2}\right)\right)$ is undefined.
111. $\operatorname{arcsec}\left(\sec\left(\frac{5\pi}{3}\right)\right) = \frac{\pi}{3}$
112. $\operatorname{arccsc}\left(\csc\left(\frac{\pi}{6}\right)\right) = \frac{\pi}{6}$

113. $\operatorname{arccsc} \left(\csc \left(\frac{5\pi}{4} \right) \right) = \frac{5\pi}{4}$

115. $\operatorname{arccsc} \left(\csc \left(-\frac{\pi}{2} \right) \right) = \frac{3\pi}{2}$

117. $\operatorname{arcsec} \left(\sec \left(\frac{11\pi}{12} \right) \right) = \frac{13\pi}{12}$

119. $\operatorname{arcsec} \left(\sec \left(\frac{\pi}{4} \right) \right) = \frac{\pi}{4}$

121. $\operatorname{arcsec} \left(\sec \left(\frac{5\pi}{6} \right) \right) = \frac{5\pi}{6}$

123. $\operatorname{arcsec} \left(\sec \left(\frac{5\pi}{3} \right) \right) = \frac{\pi}{3}$

125. $\operatorname{arccsc} \left(\csc \left(\frac{5\pi}{4} \right) \right) = -\frac{\pi}{4}$

127. $\operatorname{arccsc} \left(\csc \left(-\frac{\pi}{2} \right) \right) = -\frac{\pi}{2}$

129. $\operatorname{arcsec} \left(\sec \left(\frac{11\pi}{12} \right) \right) = \frac{11\pi}{12}$

131. $\sin \left(\arccos \left(-\frac{1}{2} \right) \right) = \frac{\sqrt{3}}{2}$

133. $\sin (\arctan (-2)) = -\frac{2\sqrt{5}}{5}$

135. $\sin (\operatorname{arccsc} (-3)) = -\frac{1}{3}$

137. $\cos (\arctan (\sqrt{7})) = \frac{\sqrt{2}}{4}$

139. $\cos (\operatorname{arcsec} (5)) = \frac{1}{5}$

141. $\tan \left(\arccos \left(-\frac{1}{2} \right) \right) = -\sqrt{3}$

143. $\tan (\operatorname{arccot} (12)) = \frac{1}{12}$

114. $\operatorname{arccsc} \left(\csc \left(\frac{2\pi}{3} \right) \right) = \frac{\pi}{3}$

116. $\operatorname{arccsc} \left(\csc \left(\frac{11\pi}{6} \right) \right) = \frac{7\pi}{6}$

118. $\operatorname{arccsc} \left(\csc \left(\frac{9\pi}{8} \right) \right) = \frac{9\pi}{8}$

120. $\operatorname{arcsec} \left(\sec \left(\frac{4\pi}{3} \right) \right) = \frac{2\pi}{3}$

122. $\operatorname{arcsec} \left(\sec \left(-\frac{\pi}{2} \right) \right)$ is undefined.

124. $\operatorname{arccsc} \left(\csc \left(\frac{\pi}{6} \right) \right) = \frac{\pi}{6}$

126. $\operatorname{arccsc} \left(\csc \left(\frac{2\pi}{3} \right) \right) = \frac{\pi}{3}$

128. $\operatorname{arccsc} \left(\csc \left(\frac{11\pi}{6} \right) \right) = -\frac{\pi}{6}$

130. $\operatorname{arccsc} \left(\csc \left(\frac{9\pi}{8} \right) \right) = -\frac{\pi}{8}$

132. $\sin \left(\arccos \left(\frac{3}{5} \right) \right) = \frac{4}{5}$

134. $\sin (\operatorname{arccot} (\sqrt{5})) = \frac{\sqrt{6}}{6}$

136. $\cos \left(\arcsin \left(-\frac{5}{13} \right) \right) = \frac{12}{13}$

138. $\cos (\operatorname{arccot} (3)) = \frac{3\sqrt{10}}{10}$

140. $\tan \left(\arcsin \left(-\frac{2\sqrt{5}}{5} \right) \right) = -2$

142. $\tan \left(\operatorname{arcsec} \left(\frac{5}{3} \right) \right) = \frac{4}{3}$

144. $\cot \left(\arcsin \left(\frac{12}{13} \right) \right) = \frac{5}{12}$

145. $\cot \left(\arccos \left(\frac{\sqrt{3}}{2} \right) \right) = \sqrt{3}$

146. $\cot (\operatorname{arccsc} (\sqrt{5})) = 2$

147. $\cot (\arctan (0.25)) = 4$

148. $\sec \left(\arccos \left(\frac{\sqrt{3}}{2} \right) \right) = \frac{2\sqrt{3}}{3}$

149. $\sec \left(\arcsin \left(-\frac{12}{13} \right) \right) = \frac{13}{5}$

150. $\sec (\arctan (10)) = \sqrt{101}$

151. $\sec \left(\operatorname{arccot} \left(-\frac{\sqrt{10}}{10} \right) \right) = -\sqrt{11}$

152. $\csc (\operatorname{arccot} (9)) = \sqrt{82}$

153. $\csc \left(\arcsin \left(\frac{3}{5} \right) \right) = \frac{5}{3}$

154. $\csc \left(\arctan \left(-\frac{2}{3} \right) \right) = -\frac{\sqrt{13}}{2}$

155. $\sin \left(\arcsin \left(\frac{5}{13} \right) + \frac{\pi}{4} \right) = \frac{17\sqrt{2}}{26}$

156. $\cos (\operatorname{arcsec}(3) + \arctan(2)) = \frac{\sqrt{5} - 4\sqrt{10}}{15}$

157. $\tan \left(\arctan(3) + \arccos \left(-\frac{3}{5} \right) \right) = \frac{1}{3}$

158. $\sin \left(2 \arcsin \left(-\frac{4}{5} \right) \right) = -\frac{24}{25}$

159. $\sin \left(2 \operatorname{arccsc} \left(\frac{13}{5} \right) \right) = \frac{120}{169}$

160. $\sin (2 \arctan (2)) = \frac{4}{5}$

161. $\cos \left(2 \arcsin \left(\frac{3}{5} \right) \right) = \frac{7}{25}$

162. $\cos \left(2 \operatorname{arcsec} \left(\frac{25}{7} \right) \right) = -\frac{527}{625}$

163. $\cos (2 \operatorname{arccot} (-\sqrt{5})) = \frac{2}{3}$

164. $\sin \left(\frac{\arctan(2)}{2} \right) = \sqrt{\frac{5 - \sqrt{5}}{10}}$

165. $\sin (\arccos (x)) = \sqrt{1 - x^2}$ for $-1 \leq x \leq 1$

166. $\cos (\arctan (x)) = \frac{1}{\sqrt{1 + x^2}}$ for all x

167. $\tan (\arcsin (x)) = \frac{x}{\sqrt{1 - x^2}}$ for $-1 < x < 1$

168. $\sec (\arctan (x)) = \sqrt{1 + x^2}$ for all x

169. $\csc (\arccos (x)) = \frac{1}{\sqrt{1 - x^2}}$ for $-1 < x < 1$

170. $\sin (2 \arctan (x)) = \frac{2x}{x^2 + 1}$ for all x

171. $\sin (2 \arccos (x)) = 2x\sqrt{1 - x^2}$ for $-1 \leq x \leq 1$

$$172. \cos(2 \arctan(x)) = \frac{1-x^2}{1+x^2} \text{ for all } x$$

$$173. \sin(\arccos(2x)) = \sqrt{1-4x^2} \text{ for } -\frac{1}{2} \leq x \leq \frac{1}{2}$$

$$174. \sin\left(\arccos\left(\frac{x}{5}\right)\right) = \frac{\sqrt{25-x^2}}{5} \text{ for } -5 \leq x \leq 5$$

$$175. \cos\left(\arcsin\left(\frac{x}{2}\right)\right) = \frac{\sqrt{4-x^2}}{2} \text{ for } -2 \leq x \leq 2$$

$$176. \cos(\arctan(3x)) = \frac{1}{\sqrt{1+9x^2}} \text{ for all } x$$

$$177. \sin(2 \arcsin(7x)) = 14x\sqrt{1-49x^2} \text{ for } -\frac{1}{7} \leq x \leq \frac{1}{7}$$

$$178. \sin\left(2 \arcsin\left(\frac{x\sqrt{3}}{3}\right)\right) = \frac{2x\sqrt{3-x^2}}{3} \text{ for } -\sqrt{3} \leq x \leq \sqrt{3}$$

$$179. \cos(2 \arcsin(4x)) = 1-32x^2 \text{ for } -\frac{1}{4} \leq x \leq \frac{1}{4}$$

$$180. \sec(\arctan(2x)) \tan(\arctan(2x)) = 2x\sqrt{1+4x^2} \text{ for all } x$$

$$181. \sin(\arcsin(x) + \arccos(x)) = 1 \text{ for } -1 \leq x \leq 1$$

$$182. \cos(\arcsin(x) + \arctan(x)) = \frac{\sqrt{1-x^2}-x^2}{\sqrt{1+x^2}} \text{ for } -1 \leq x \leq 1$$

$$183. \text{}^{10} \tan(2 \arcsin(x)) = \frac{2x\sqrt{1-x^2}}{1-2x^2} \text{ for } x \text{ in } \left(-1, -\frac{\sqrt{2}}{2}\right) \cup \left(-\frac{\sqrt{2}}{2}, \frac{\sqrt{2}}{2}\right) \cup \left(\frac{\sqrt{2}}{2}, 1\right)$$

$$184. \sin\left(\frac{1}{2} \arctan(x)\right) = \begin{cases} \sqrt{\frac{\sqrt{x^2+1}-1}{2\sqrt{x^2+1}}} & \text{for } x \geq 0 \\ -\sqrt{\frac{\sqrt{x^2+1}-1}{2\sqrt{x^2+1}}} & \text{for } x < 0 \end{cases}$$

$$185. \text{ If } \sin(\theta) = \frac{x}{2} \text{ for } -\frac{\pi}{2} < \theta < \frac{\pi}{2}, \text{ then } \theta + \sin(2\theta) = \arcsin\left(\frac{x}{2}\right) + \frac{x\sqrt{4-x^2}}{2}$$

$$186. \text{ If } \tan(\theta) = \frac{x}{7} \text{ for } -\frac{\pi}{2} < \theta < \frac{\pi}{2}, \text{ then } \frac{1}{2}\theta - \frac{1}{2}\sin(2\theta) = \frac{1}{2} \arctan\left(\frac{x}{7}\right) - \frac{7x}{x^2+49}$$

¹⁰The equivalence for $x = \pm 1$ can be verified independently of the derivation of the formula, but Calculus is required to fully understand what is happening at those x values. You'll see what we mean when you work through the details of the identity for $\tan(2t)$. For now, we exclude $x = \pm 1$ from our answer.

187. If $\sec(\theta) = \frac{x}{4}$ for $0 < \theta < \frac{\pi}{2}$, then $4 \tan(\theta) - 4\theta = \sqrt{x^2 - 16} - 4 \operatorname{arcsec}\left(\frac{x}{4}\right)$
188. $x = \arcsin\left(\frac{7}{11}\right) + 2\pi k$ or $x = \pi - \arcsin\left(\frac{7}{11}\right) + 2\pi k$, in $[0, 2\pi)$, $x \approx 0.6898, 2.4518$
189. $x = \arccos\left(-\frac{2}{9}\right) + 2\pi k$ or $x = -\arccos\left(-\frac{2}{9}\right) + 2\pi k$, in $[0, 2\pi)$, $x \approx 1.7949, 4.4883$
190. $x = \pi + \arcsin(0.569) + 2\pi k$ or $x = 2\pi - \arcsin(0.569) + 2\pi k$, in $[0, 2\pi)$, $x \approx 3.7469, 5.6779$
191. $x = \arccos(0.117) + 2\pi k$ or $x = 2\pi - \arccos(0.117) + 2\pi k$, in $[0, 2\pi)$, $x \approx 1.4535, 4.8297$
192. $x = \arcsin(0.008) + 2\pi k$ or $x = \pi - \arcsin(0.008) + 2\pi k$, in $[0, 2\pi)$, $x \approx 0.0080, 3.1336$
193. $x = \arccos\left(\frac{359}{360}\right) + 2\pi k$ or $x = 2\pi - \arccos\left(\frac{359}{360}\right) + 2\pi k$, in $[0, 2\pi)$, $x \approx 0.0746, 6.2086$
194. $x = \arctan(117) + \pi k$, in $[0, 2\pi)$, $x \approx 1.56225, 4.70384$
195. $x = \arctan\left(-\frac{1}{12}\right) + \pi k$, in $[0, 2\pi)$, $x \approx 3.0585, 6.2000$
196. $x = \arccos\left(\frac{2}{3}\right) + 2\pi k$ or $x = 2\pi - \arccos\left(\frac{2}{3}\right) + 2\pi k$, in $[0, 2\pi)$, $x \approx 0.8411, 5.4422$
197. $x = \pi + \arcsin\left(\frac{17}{90}\right) + 2\pi k$ or $x = 2\pi - \arcsin\left(\frac{17}{90}\right) + 2\pi k$, in $[0, 2\pi)$, $x \approx 3.3316, 6.0932$
198. $x = \arctan(-\sqrt{10}) + \pi k$, in $[0, 2\pi)$, $x \approx 1.8771, 5.0187$
199. $x = \arcsin\left(\frac{3}{8}\right) + 2\pi k$ or $x = \pi - \arcsin\left(\frac{3}{8}\right) + 2\pi k$, in $[0, 2\pi)$, $x \approx 0.3844, 2.7572$
200. $x = \arccos\left(-\frac{7}{16}\right) + 2\pi k$ or $x = -\arccos\left(-\frac{7}{16}\right) + 2\pi k$, in $[0, 2\pi)$, $x \approx 2.0236, 4.2596$
201. $x = \arctan(0.03) + \pi k$, in $[0, 2\pi)$, $x \approx 0.0300, 3.1716$
202. $x = \arcsin(0.3502) + 2\pi k$ or $x = \pi - \arcsin(0.3502) + 2\pi k$, in $[0, 2\pi)$, $x \approx 0.3578, 2.784$
203. $x = \pi + \arcsin(0.721) + 2\pi k$ or $x = 2\pi - \arcsin(0.721) + 2\pi k$, in $[0, 2\pi)$, $x \approx 3.9468, 5.4780$
204. $x = \arccos(0.9824) + 2\pi k$ or $x = 2\pi - \arccos(0.9824) + 2\pi k$, in $[0, 2\pi)$, $x \approx 0.1879, 6.0953$
205. $x = \arccos(-0.5637) + 2\pi k$ or $x = -\arccos(-0.5637) + 2\pi k$, in $[0, 2\pi)$, $x \approx 2.1697, 4.1135$
206. $x = \arctan(117) + \pi k$, in $[0, 2\pi)$, $x \approx 1.5622, 4.7038$
207. $x = \arctan(-0.6109) + \pi k$, in $[0, 2\pi)$, $x \approx 2.5932, 5.7348$

208. 36.87° and 53.13° 209. 22.62° and 67.38° 210. 32.52° and 57.48°
211. 68.9° 212. 7.7° 213. 51° 214. 19.5° 215. 41.81°
216. $f(x) = 5 \sin(3x) + 12 \cos(3x) = 13 \sin\left(3x + \arcsin\left(\frac{12}{13}\right)\right) \approx 13 \sin(3x + 1.1760)$
217. $f(x) = 3 \cos(2x) + 4 \sin(2x) = 5 \sin\left(2x + \arcsin\left(\frac{3}{5}\right)\right) \approx 5 \sin(2x + 0.6435)$
218. $f(x) = \cos(x) - 3 \sin(x) = \sqrt{10} \sin\left(x + \arccos\left(-\frac{3\sqrt{10}}{10}\right)\right) \approx \sqrt{10} \sin(x + 2.8198)$
219. $f(x) = 7 \sin(10x) - 24 \cos(10x) = 25 \sin\left(10x + \arcsin\left(-\frac{24}{25}\right)\right) \approx 25 \sin(10x - 1.2870)$
220. $f(x) = -\cos(x) - 2\sqrt{2} \sin(x) = 3 \sin\left(x + \pi + \arcsin\left(\frac{1}{3}\right)\right) \approx 3 \sin(x + 3.4814)$
221. $f(x) = 2 \sin(x) - \cos(x) = \sqrt{5} \sin\left(x + \arcsin\left(-\frac{\sqrt{5}}{5}\right)\right) \approx \sqrt{5} \sin(x - 0.4636)$
222. $\left[-\frac{1}{5}, \frac{1}{5}\right]$ 223. $\left[-\frac{1}{3}, 1\right]$
224. $\left[-\frac{\sqrt{2}}{2}, \frac{\sqrt{2}}{2}\right]$ 225. $(-\infty, -\sqrt{5}] \cup [-\sqrt{3}, \sqrt{3}] \cup [\sqrt{5}, \infty)$
226. $(-\infty, \infty)$ 227. $(-\infty, -3) \cup (-3, 3) \cup (3, \infty)$
228. $\left(\frac{1}{2}, \infty\right)$ 229. $\left[\frac{1}{2}, \infty\right)$
230. $\left(-\infty, -\frac{1}{12}\right] \cup \left[\frac{1}{12}, \infty\right)$ 231. $(-\infty, -6] \cup [-4, \infty)$
232. $(-\infty, -2] \cup [2, \infty)$ 233. $[0, \infty)$

8.7 TRIGONOMETRIC EQUATIONS AND INEQUALITIES

In Sections 8.2, 8.3 and most recently 8.6, we solved some basic equations involving the trigonometric functions. Below we summarize the techniques we've employed thus far. Note that we use the neutral letter 'u' as the argument¹ of each circular function for generality.

Strategies for Solving Basic Equations Involving Trigonometric Functions

- To solve $\cos(u) = c$ or $\sin(u) = c$ for $-1 \leq c \leq 1$, first solve for u in the interval $[0, 2\pi)$ and add integer multiples of the period 2π . If $c < -1$ or of $c > 1$, there are no real solutions.
- To solve $\sec(u) = c$ or $\csc(u) = c$ for $c \leq -1$ or $c \geq 1$, convert to cosine or sine, respectively, and solve as above. If $-1 < c < 1$, there are no real solutions.
- To solve $\tan(u) = c$ for any real number c , first solve for u in the interval $(-\frac{\pi}{2}, \frac{\pi}{2})$ and add integer multiples of the period π .
- To solve $\cot(u) = c$ for $c \neq 0$, convert to tangent and solve as above. If $c = 0$, the solution to $\cot(u) = 0$ is $u = \frac{\pi}{2} + \pi k$ for integers k .

Using the above guidelines, we can comfortably solve $\sin(x) = \frac{1}{2}$ and find the solution $x = \frac{\pi}{6} + 2\pi k$ or $x = \frac{5\pi}{6} + 2\pi k$ for integers k . How do we solve something like $\sin(3x) = \frac{1}{2}$? Since this equation has the *form* $\sin(u) = \frac{1}{2}$, we know the solutions take the form $u = \frac{\pi}{6} + 2\pi k$ or $u = \frac{5\pi}{6} + 2\pi k$ for integers k . Since the argument of sine here is $3x$, we have $3x = \frac{\pi}{6} + 2\pi k$ or $3x = \frac{5\pi}{6} + 2\pi k$ for integers k . To solve for x , we divide both sides² of these equations by 3, and obtain $x = \frac{\pi}{18} + \frac{2\pi}{3}k$ or $x = \frac{5\pi}{18} + \frac{2\pi}{3}k$ for integers k . This is the technique employed in the example below.

Example 8.7.1. Solve the following equations and check your answers analytically. List the solutions which lie in the interval $[0, 2\pi)$ and verify them using a graphing utility.

1. $\cos(2x) = -\frac{\sqrt{3}}{2}$
2. $\csc(\frac{1}{3}x - \pi) = \sqrt{2}$
3. $\cot(3x) = 0$
4. $\sec^2(x) = 4$
5. $\tan(\frac{x}{2}) = -3$
6. $\sin(2x) = 0.87$

Solution.

1. The solutions to $\cos(u) = -\frac{\sqrt{3}}{2}$ are $u = \frac{5\pi}{6} + 2\pi k$ or $u = \frac{7\pi}{6} + 2\pi k$ for integers k . Since the argument of cosine here is $2x$, this means $2x = \frac{5\pi}{6} + 2\pi k$ or $2x = \frac{7\pi}{6} + 2\pi k$ for integers k . Solving for x gives $x = \frac{5\pi}{12} + \pi k$ or $x = \frac{7\pi}{12} + \pi k$ for integers k . To check these answers analytically, we substitute them into the original equation. For any integer k we have

$$\begin{aligned} \cos\left(2\left[\frac{5\pi}{12} + \pi k\right]\right) &= \cos\left(\frac{5\pi}{6} + 2\pi k\right) \\ &= \cos\left(\frac{5\pi}{6}\right) && \text{(the period of cosine is } 2\pi\text{)} \\ &= -\frac{\sqrt{3}}{2} \end{aligned}$$

¹See the comments at the beginning of Section 8.5 for a review of this concept.

²Don't forget to divide the $2\pi k$ by 3 as well!

Similarly, we find $\cos(2[\frac{7\pi}{12} + \pi k]) = \cos(\frac{7\pi}{6} + 2\pi k) = \cos(\frac{7\pi}{6}) = -\frac{\sqrt{3}}{2}$. To determine which of our solutions lie in $[0, 2\pi)$, we substitute integer values for k . The solutions we keep come from the values of $k = 0$ and $k = 1$ and are $x = \frac{5\pi}{12}, \frac{7\pi}{12}, \frac{17\pi}{12}$ and $\frac{19\pi}{12}$. Using a calculator, we graph $y = \cos(2x)$ and $y = -\frac{\sqrt{3}}{2}$ over $[0, 2\pi)$ and examine where these two graphs intersect. We see that the x -coordinates of the intersection points correspond to the decimal representations of our exact answers.

2. Since this equation has the form $\csc(u) = \sqrt{2}$, we rewrite this as $\sin(u) = \frac{\sqrt{2}}{2}$ and find $u = \frac{\pi}{4} + 2\pi k$ or $u = \frac{3\pi}{4} + 2\pi k$ for integers k . Since the argument of cosecant here is $(\frac{1}{3}x - \pi)$,

$$\frac{1}{3}x - \pi = \frac{\pi}{4} + 2\pi k \quad \text{or} \quad \frac{1}{3}x - \pi = \frac{3\pi}{4} + 2\pi k$$

To solve $\frac{1}{3}x - \pi = \frac{\pi}{4} + 2\pi k$, we first add π to both sides

$$\frac{1}{3}x = \frac{\pi}{4} + 2\pi k + \pi$$

A common error is to treat the ' $2\pi k$ ' and ' π ' terms as 'like' terms and try to combine them when they are not.³ We can, however, combine the ' π ' and ' $\frac{\pi}{4}$ ' terms to get

$$\frac{1}{3}x = \frac{5\pi}{4} + 2\pi k$$

We now finish by multiplying both sides by 3 to get

$$x = 3\left(\frac{5\pi}{4} + 2\pi k\right) = \frac{15\pi}{4} + 6\pi k$$

Solving the other equation, $\frac{1}{3}x - \pi = \frac{3\pi}{4} + 2\pi k$ produces $x = \frac{21\pi}{4} + 6\pi k$ for integers k . To check the first family of answers, we substitute, combine like terms, and simplify.

$$\begin{aligned} \csc\left(\frac{1}{3}\left[\frac{15\pi}{4} + 6\pi k\right] - \pi\right) &= \csc\left(\frac{5\pi}{4} + 2\pi k - \pi\right) \\ &= \csc\left(\frac{\pi}{4} + 2\pi k\right) \\ &= \csc\left(\frac{\pi}{4}\right) && \text{(the period of cosecant is } 2\pi) \\ &= \sqrt{2} \end{aligned}$$

The family $x = \frac{21\pi}{4} + 6\pi k$ checks similarly. Despite having infinitely many solutions, we find that *none* of them lie in $[0, 2\pi)$. To verify this graphically, we use a reciprocal identity to rewrite the cosecant as a sine and we find that $y = \frac{1}{\sin(\frac{1}{3}x - \pi)}$ and $y = \sqrt{2}$ do not intersect at all over the interval $[0, 2\pi)$.

³Do you see why?

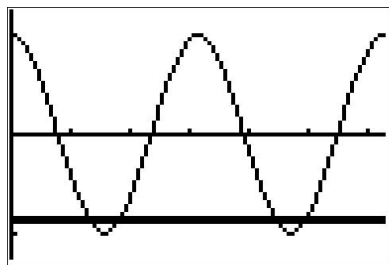

$$y = \cos(2x) \text{ and } y = -\frac{\sqrt{3}}{2}$$

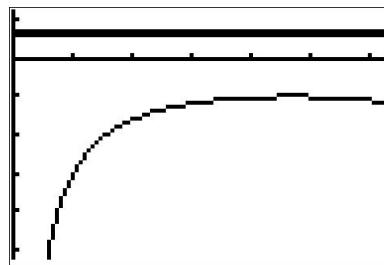

$$y = \frac{1}{\sin(\frac{1}{3}x - \pi)} \text{ and } y = \sqrt{2}$$

3. Since $\cot(3x) = 0$ has the form $\cot(u) = 0$, we know $u = \frac{\pi}{2} + \pi k$, so, in this case, $3x = \frac{\pi}{2} + \pi k$ for integers k . Solving for x yields $x = \frac{\pi}{6} + \frac{\pi}{3}k$. Checking our answers, we get

$$\begin{aligned} \cot\left(3\left[\frac{\pi}{6} + \frac{\pi}{3}k\right]\right) &= \cot\left(\frac{\pi}{2} + \pi k\right) \\ &= \cot\left(\frac{\pi}{2}\right) \quad (\text{the period of cotangent is } \pi) \\ &= 0 \end{aligned}$$

As k runs through the integers, we obtain six answers, corresponding to $k = 0$ through $k = 5$, which lie in $[0, 2\pi)$: $x = \frac{\pi}{6}, \frac{\pi}{2}, \frac{5\pi}{6}, \frac{7\pi}{6}, \frac{3\pi}{2}$ and $\frac{11\pi}{6}$. To confirm these graphically, we must be careful. On many calculators, there is no function button for cotangent. We choose⁴ to use the quotient identity $\cot(3x) = \frac{\cos(3x)}{\sin(3x)}$. Graphing $y = \frac{\cos(3x)}{\sin(3x)}$ and $y = 0$ (the x -axis), we see that the x -coordinates of the intersection points approximately match our solutions.

4. The complication in solving an equation like $\sec^2(x) = 4$ comes not from the argument of secant, which is just x , but rather, the fact the secant is being squared. To get this equation to look like one of the forms listed on page 825, we extract square roots to get $\sec(x) = \pm 2$. Converting to cosines, we have $\cos(x) = \pm \frac{1}{2}$. For $\cos(x) = \frac{1}{2}$, we get $x = \frac{\pi}{3} + 2\pi k$ or $x = \frac{5\pi}{3} + 2\pi k$ for integers k . For $\cos(x) = -\frac{1}{2}$, we get $x = \frac{2\pi}{3} + 2\pi k$ or $x = \frac{4\pi}{3} + 2\pi k$ for integers k . If we take a step back and think of these families of solutions geometrically, we see we are finding the measures of all angles with a reference angle of $\frac{\pi}{3}$. As a result, these solutions can be combined and we may write our solutions as $x = \frac{\pi}{3} + \pi k$ and $x = \frac{2\pi}{3} + \pi k$ for integers k . To check the first family of solutions, we note that, depending on the integer k , $\sec\left(\frac{\pi}{3} + \pi k\right)$ doesn't always equal $\sec\left(\frac{\pi}{3}\right)$. However, it is true that for all integers k , $\sec\left(\frac{\pi}{3} + \pi k\right) = \pm \sec\left(\frac{\pi}{3}\right) = \pm 2$. (Can you show this?) As a result,

$$\begin{aligned} \sec^2\left(\frac{\pi}{3} + \pi k\right) &= \left(\pm \sec\left(\frac{\pi}{3}\right)\right)^2 \\ &= (\pm 2)^2 \\ &= 4 \end{aligned}$$

The same holds for the family $x = \frac{2\pi}{3} + \pi k$. The solutions which lie in $[0, 2\pi)$ come from the values $k = 0$ and $k = 1$, namely $x = \frac{\pi}{3}, \frac{2\pi}{3}, \frac{4\pi}{3}$ and $\frac{5\pi}{3}$. To confirm graphically, we use

⁴The reader is encouraged to see what happens if we had chosen the reciprocal identity $\cot(3x) = \frac{1}{\tan(3x)}$ instead. The graph on the calculator *appears* identical, but what happens when you try to find the intersection points?

a reciprocal identity to rewrite the secant as cosine. The x -coordinates of the intersection points of $y = \frac{1}{(\cos(x))^2}$ and $y = 4$ verify our answers.

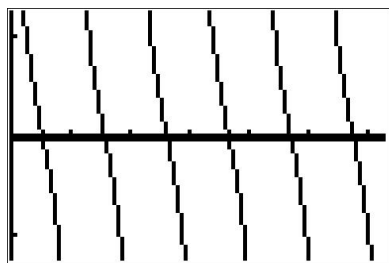

$$y = \frac{\cos(3x)}{\sin(3x)} \text{ and } y = 0$$

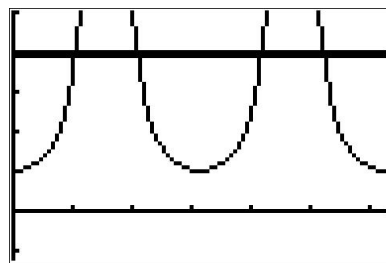

$$y = \frac{1}{\cos^2(x)} \text{ and } y = 4$$

5. The equation $\tan\left(\frac{x}{2}\right) = -3$ has the form $\tan(u) = -3$, whose solution is $u = \arctan(-3) + \pi k$. Hence, $\frac{x}{2} = \arctan(-3) + \pi k$, so $x = 2 \arctan(-3) + 2\pi k$ for integers k . To check, we note

$$\begin{aligned} \tan\left(\frac{2 \arctan(-3) + 2\pi k}{2}\right) &= \tan(\arctan(-3) + \pi k) \\ &= \tan(\arctan(-3)) && \text{(the period of tangent is } \pi) \\ &= -3 && \text{(See Theorem 8.27)} \end{aligned}$$

To determine which of our answers lie in the interval $[0, 2\pi)$, we first need to get an idea of the value of $2 \arctan(-3)$. While we could easily find an approximation using a calculator,⁵ we proceed analytically. Since $-3 < 0$, it follows that $-\frac{\pi}{2} < \arctan(-3) < 0$. Multiplying through by 2 gives $-\pi < 2 \arctan(-3) < 0$. We are now in a position to argue which of the solutions $x = 2 \arctan(-3) + 2\pi k$ lie in $[0, 2\pi)$. For $k = 0$, we get $x = 2 \arctan(-3) < 0$, so we discard this answer and all answers $x = 2 \arctan(-3) + 2\pi k$ where $k < 0$. Next, we turn our attention to $k = 1$ and get $x = 2 \arctan(-3) + 2\pi$. Starting with the inequality $-\pi < 2 \arctan(-3) < 0$, we add 2π and get $\pi < 2 \arctan(-3) + 2\pi < 2\pi$. This means $x = 2 \arctan(-3) + 2\pi$ lies in $[0, 2\pi)$. Advancing k to 2 produces $x = 2 \arctan(-3) + 4\pi$. Once again, we get from $-\pi < 2 \arctan(-3) < 0$ that $3\pi < 2 \arctan(-3) + 4\pi < 4\pi$. Since this is outside the interval $[0, 2\pi)$, we discard $x = 2 \arctan(-3) + 4\pi$ and all solutions of the form $x = 2 \arctan(-3) + 2\pi k$ for $k > 2$. Graphically, we see $y = \tan\left(\frac{x}{2}\right)$ and $y = -3$ intersect only once on $[0, 2\pi)$ at $x = 2 \arctan(-3) + 2\pi \approx 3.7851$.

6. To solve $\sin(2x) = 0.87$, we first note that it has the form $\sin(u) = 0.87$, which has the family of solutions $u = \arcsin(0.87) + 2\pi k$ or $u = \pi - \arcsin(0.87) + 2\pi k$ for integers k . Since the argument of sine here is $2x$, we get $2x = \arcsin(0.87) + 2\pi k$ or $2x = \pi - \arcsin(0.87) + 2\pi k$ which gives $x = \frac{1}{2} \arcsin(0.87) + \pi k$ or $x = \frac{\pi}{2} - \frac{1}{2} \arcsin(0.87) + \pi k$ for integers k . To check,

⁵Your instructor will let you know if you should abandon the analytic route at this point and use your calculator. But seriously, what fun would that be?

$$\begin{aligned}
 \sin\left(2\left[\frac{1}{2}\arcsin(0.87) + \pi k\right]\right) &= \sin(\arcsin(0.87) + 2\pi k) \\
 &= \sin(\arcsin(0.87)) && \text{(the period of sine is } 2\pi) \\
 &= 0.87 && \text{(See Theorem 8.26)}
 \end{aligned}$$

For the family $x = \frac{\pi}{2} - \frac{1}{2}\arcsin(0.87) + \pi k$, we get

$$\begin{aligned}
 \sin\left(2\left[\frac{\pi}{2} - \frac{1}{2}\arcsin(0.87) + \pi k\right]\right) &= \sin(\pi - \arcsin(0.87) + 2\pi k) \\
 &= \sin(\pi - \arcsin(0.87)) && \text{(the period of sine is } 2\pi) \\
 &= \sin(\arcsin(0.87)) && \text{(}\sin(\pi - t) = \sin(t)\text{)} \\
 &= 0.87 && \text{(See Theorem 8.26)}
 \end{aligned}$$

To determine which of these solutions lie in $[0, 2\pi)$, we first need to get an idea of the value of $x = \frac{1}{2}\arcsin(0.87)$. Once again, we could use the calculator, but we adopt an analytic route here. By definition, $0 < \arcsin(0.87) < \frac{\pi}{2}$ so that multiplying through by $\frac{1}{2}$ gives us $0 < \frac{1}{2}\arcsin(0.87) < \frac{\pi}{4}$. Starting with the family of solutions $x = \frac{1}{2}\arcsin(0.87) + \pi k$, we use the same kind of arguments as in our solution to number 5 above and find only the solutions corresponding to $k = 0$ and $k = 1$ lie in $[0, 2\pi)$: $x = \frac{1}{2}\arcsin(0.87)$ and $x = \frac{1}{2}\arcsin(0.87) + \pi$. Next, we move to the family $x = \frac{\pi}{2} - \frac{1}{2}\arcsin(0.87) + \pi k$ for integers k . Here, we need to get a better estimate of $\frac{\pi}{2} - \frac{1}{2}\arcsin(0.87)$. From the inequality $0 < \frac{1}{2}\arcsin(0.87) < \frac{\pi}{4}$, we first multiply through by -1 and then add $\frac{\pi}{2}$ to get $\frac{\pi}{2} > \frac{\pi}{2} - \frac{1}{2}\arcsin(0.87) > \frac{\pi}{4}$, or $\frac{\pi}{4} < \frac{\pi}{2} - \frac{1}{2}\arcsin(0.87) < \frac{\pi}{2}$. Proceeding with the usual arguments, we find the only solutions which lie in $[0, 2\pi)$ correspond to $k = 0$ and $k = 1$, namely $x = \frac{\pi}{2} - \frac{1}{2}\arcsin(0.87)$ and $x = \frac{3\pi}{2} - \frac{1}{2}\arcsin(0.87)$. All told, we have found four solutions to $\sin(2x) = 0.87$ in $[0, 2\pi)$: $x = \frac{1}{2}\arcsin(0.87)$, $x = \frac{1}{2}\arcsin(0.87) + \pi$, $x = \frac{\pi}{2} - \frac{1}{2}\arcsin(0.87)$ and $x = \frac{3\pi}{2} - \frac{1}{2}\arcsin(0.87)$. By graphing $y = \sin(2x)$ and $y = 0.87$, we confirm our results.

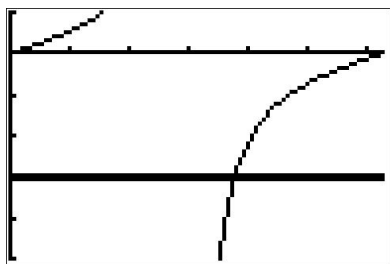

$y = \tan\left(\frac{x}{2}\right)$ and $y = -3$

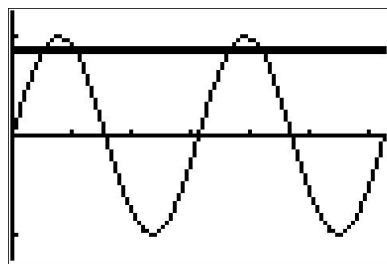

$y = \sin(2x)$ and $y = 0.87$

□

Each of the problems in Example 8.7.1 featured one trigonometric function. If an equation involves two different trigonometric functions or if the equation contains the same trigonometric function but with different arguments, we will need to use identities and Algebra to reduce the equation to the same form as those given on page 825.

Example 8.7.2. Solve the following equations and list the solutions which lie in the interval $[0, 2\pi)$. Verify your solutions on $[0, 2\pi)$ graphically.

- | | |
|--|-------------------------------------|
| 1. $3 \sin^3(x) = \sin^2(x)$ | 2. $\sec^2(x) = \tan(x) + 3$ |
| 3. $\cos(2x) = 3 \cos(x) - 2$ | 4. $\cos(3x) = 2 - \cos(x)$ |
| 5. $\cos(3x) = \cos(5x)$ | 6. $\sin(2x) = \sqrt{3} \cos(x)$ |
| 7. $\sin(x) \cos\left(\frac{x}{2}\right) + \cos(x) \sin\left(\frac{x}{2}\right) = 1$ | 8. $\cos(x) - \sqrt{3} \sin(x) = 2$ |

Solution.

1. We resist the temptation to divide both sides of $3 \sin^3(x) = \sin^2(x)$ by $\sin^2(x)$ (What goes wrong if you do?) and instead gather all of the terms to one side of the equation and factor.

$$\begin{aligned} 3 \sin^3(x) &= \sin^2(x) \\ 3 \sin^3(x) - \sin^2(x) &= 0 \\ \sin^2(x)(3 \sin(x) - 1) &= 0 \end{aligned} \quad \text{Factor out } \sin^2(x) \text{ from both terms.}$$

We get $\sin^2(x) = 0$ or $3 \sin(x) - 1 = 0$. Solving for $\sin(x)$, we find $\sin(x) = 0$ or $\sin(x) = \frac{1}{3}$. The solution to the first equation is $x = \pi k$, with $x = 0$ and $x = \pi$ being the two solutions which lie in $[0, 2\pi)$. To solve $\sin(x) = \frac{1}{3}$, we use the arcsine function to get $x = \arcsin\left(\frac{1}{3}\right) + 2\pi k$ or $x = \pi - \arcsin\left(\frac{1}{3}\right) + 2\pi k$ for integers k . We find the two solutions here which lie in $[0, 2\pi)$ to be $x = \arcsin\left(\frac{1}{3}\right)$ and $x = \pi - \arcsin\left(\frac{1}{3}\right)$. To check graphically, we plot $y = 3(\sin(x))^3$ and $y = (\sin(x))^2$ and find the x -coordinates of the intersection points of these two curves. Some extra zooming is required near $x = 0$ and $x = \pi$ to verify that these two curves do in fact intersect four times.⁶

2. Analysis of $\sec^2(x) = \tan(x) + 3$ reveals two different trigonometric functions, so an identity is in order. Since $\sec^2(x) = 1 + \tan^2(x)$, we get

$$\begin{aligned} \sec^2(x) &= \tan(x) + 3 \\ 1 + \tan^2(x) &= \tan(x) + 3 \quad (\text{Since } \sec^2(x) = 1 + \tan^2(x).) \\ \tan^2(x) - \tan(x) - 2 &= 0 \\ u^2 - u - 2 &= 0 && \text{Let } u = \tan(x). \\ (u + 1)(u - 2) &= 0 \end{aligned}$$

⁶Note that we are *not* counting the point $(2\pi, 0)$ in our solution set since $x = 2\pi$ is not in the interval $[0, 2\pi)$. In the forthcoming solutions, remember that while $x = 2\pi$ may be a solution to the equation, it isn't counted among the solutions in $[0, 2\pi)$.

This gives $u = -1$ or $u = 2$. Since $u = \tan(x)$, we have $\tan(x) = -1$ or $\tan(x) = 2$. From $\tan(x) = -1$, we get $x = -\frac{\pi}{4} + \pi k$ for integers k . To solve $\tan(x) = 2$, we employ the arctangent function and get $x = \arctan(2) + \pi k$ for integers k . From the first set of solutions, we get $x = \frac{3\pi}{4}$ and $x = \frac{7\pi}{4}$ as our answers which lie in $[0, 2\pi)$. Using the same sort of argument we saw in Example 8.7.1, we get $x = \arctan(2)$ and $x = \pi + \arctan(2)$ as answers from our second set of solutions which lie in $[0, 2\pi)$. Using a reciprocal identity, we rewrite the secant as a cosine and graph $y = \frac{1}{(\cos(x))^2}$ and $y = \tan(x) + 3$ to find the x -values of the points where they intersect.

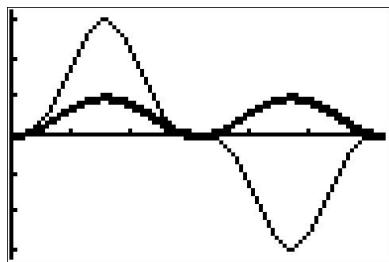

$$y = 3(\sin(x))^3 \text{ and } y = (\sin(x))^2$$

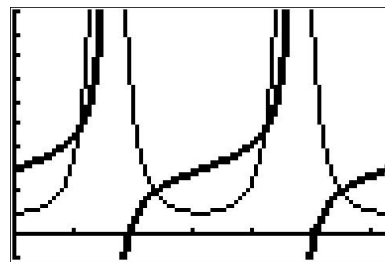

$$y = \frac{1}{(\cos(x))^2} \text{ and } y = \tan(x) + 3$$

3. In the equation $\cos(2x) = 3\cos(x) - 2$, we have the same circular function, namely cosine, on both sides but the arguments differ. Using the identity $\cos(2x) = 2\cos^2(x) - 1$, we obtain a ‘quadratic in disguise’ and proceed as we have done in the past.

$$\begin{aligned} \cos(2x) &= 3\cos(x) - 2 \\ 2\cos^2(x) - 1 &= 3\cos(x) - 2 \quad (\text{Since } \cos(2x) = 2\cos^2(x) - 1.) \\ 2\cos^2(x) - 3\cos(x) + 1 &= 0 \\ 2u^2 - 3u + 1 &= 0 && \text{Let } u = \cos(x). \\ (2u - 1)(u - 1) &= 0 \end{aligned}$$

This gives $u = \frac{1}{2}$ or $u = 1$. Since $u = \cos(x)$, we get $\cos(x) = \frac{1}{2}$ or $\cos(x) = 1$. Solving $\cos(x) = \frac{1}{2}$, we get $x = \frac{\pi}{3} + 2\pi k$ or $x = \frac{5\pi}{3} + 2\pi k$ for integers k . From $\cos(x) = 1$, we get $x = 2\pi k$ for integers k . The answers which lie in $[0, 2\pi)$ are $x = 0, \frac{\pi}{3}$, and $\frac{5\pi}{3}$. Graphing $y = \cos(2x)$ and $y = 3\cos(x) - 2$, we find, after a little extra effort, that the curves intersect in three places on $[0, 2\pi)$, and the x -coordinates of these points confirm our results.

4. To solve $\cos(3x) = 2 - \cos(x)$, we use the same technique as in the previous problem. From Example 8.4.3, number 4, we know that $\cos(3x) = 4\cos^3(x) - 3\cos(x)$. This transforms the equation into a polynomial in terms of $\cos(x)$.

$$\begin{aligned} \cos(3x) &= 2 - \cos(x) \\ 4\cos^3(x) - 3\cos(x) &= 2 - \cos(x) \\ 2\cos^3(x) - 2\cos(x) - 2 &= 0 \\ 4u^3 - 2u - 2 &= 0 && \text{Let } u = \cos(x). \end{aligned}$$

To solve $4u^3 - 2u - 2 = 0$, we need the techniques in Chapter 3 to factor $4u^3 - 2u - 2$ into $(u - 1)(4u^2 + 4u + 2)$. We get either $u - 1 = 0$ or $4u^2 + 4u + 2 = 0$, and since the discriminant of the latter is negative, the only real solution to $4u^3 - 2u - 2 = 0$ is $u = 1$. Since $u = \cos(x)$, we get $\cos(x) = 1$, so $x = 2\pi k$ for integers k . The only solution which lies in $[0, 2\pi)$ is $x = 0$. Graphing $y = \cos(3x)$ and $y = 2 - \cos(x)$ on the same set of axes over $[0, 2\pi)$ shows that the graphs intersect at what appears to be $(0, 1)$, as required.

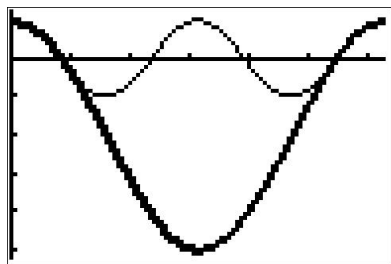

$y = \cos(2x)$ and $y = 3 \cos(x) - 2$

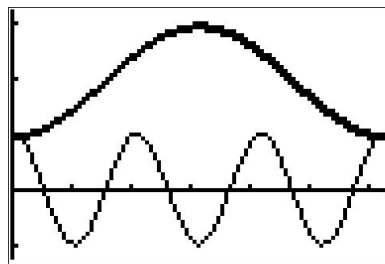

$y = \cos(3x)$ and $y = 2 - \cos(x)$

5. While we could approach $\cos(3x) = \cos(5x)$ in the same manner as we did the previous two problems, we choose instead to showcase the utility of the Sum to Product Identities. From $\cos(3x) = \cos(5x)$, we get $\cos(5x) - \cos(3x) = 0$, and it is the presence of 0 on the right hand side that indicates a switch to a product would be a good move.⁷ Using Theorem 8.21, we have that $\cos(5x) - \cos(3x) = -2 \sin\left(\frac{5x+3x}{2}\right) \sin\left(\frac{5x-3x}{2}\right) = -2 \sin(4x) \sin(x)$. Hence, the equation $\cos(5x) = \cos(3x)$ is equivalent to $-2 \sin(4x) \sin(x) = 0$. From this, we get $\sin(4x) = 0$ or $\sin(x) = 0$. Solving $\sin(4x) = 0$ gives $x = \frac{\pi}{4}k$ for integers k , and the solution to $\sin(x) = 0$ is $x = \pi k$ for integers k . The second set of solutions is contained in the first set of solutions,⁸ so our final solution to $\cos(5x) = \cos(3x)$ is $x = \frac{\pi}{4}k$ for integers k . There are eight of these answers which lie in $[0, 2\pi)$: $x = 0, \frac{\pi}{4}, \frac{\pi}{2}, \frac{3\pi}{4}, \pi, \frac{5\pi}{4}, \frac{3\pi}{2}$ and $\frac{7\pi}{4}$. Our plot of the graphs of $y = \cos(3x)$ and $y = \cos(5x)$ below (after some careful zooming) bears this out.
6. In examining the equation $\sin(2x) = \sqrt{3} \cos(x)$, not only do we have different circular functions involved, namely sine and cosine, we also have different arguments to contend with, namely $2x$ and x . Using the identity $\sin(2x) = 2 \sin(x) \cos(x)$ makes all of the arguments the same and we proceed as we would solving any nonlinear equation – gather all of the nonzero terms on one side of the equation and factor.

$$\begin{aligned} \sin(2x) &= \sqrt{3} \cos(x) \\ 2 \sin(x) \cos(x) &= \sqrt{3} \cos(x) \quad (\text{Since } \sin(2x) = 2 \sin(x) \cos(x).) \\ 2 \sin(x) \cos(x) - \sqrt{3} \cos(x) &= 0 \\ \cos(x)(2 \sin(x) - \sqrt{3}) &= 0 \end{aligned}$$

from which we get $\cos(x) = 0$ or $\sin(x) = \frac{\sqrt{3}}{2}$. From $\cos(x) = 0$, we obtain $x = \frac{\pi}{2} + \pi k$ for integers k . From $\sin(x) = \frac{\sqrt{3}}{2}$, we get $x = \frac{\pi}{3} + 2\pi k$ or $x = \frac{2\pi}{3} + 2\pi k$ for integers k . The answers

⁷As always, experience is the greatest teacher here!

⁸As always, when in doubt, write it out!

which lie in $[0, 2\pi)$ are $x = \frac{\pi}{2}, \frac{3\pi}{2}, \frac{\pi}{3}$ and $\frac{2\pi}{3}$. We graph $y = \sin(2x)$ and $y = \sqrt{3}\cos(x)$ and, after some careful zooming, verify our answers.

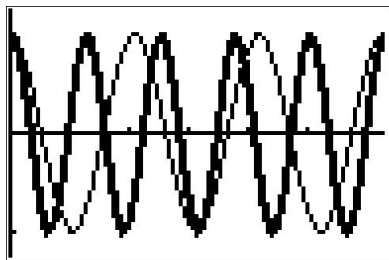

$y = \cos(3x)$ and $y = \cos(5x)$

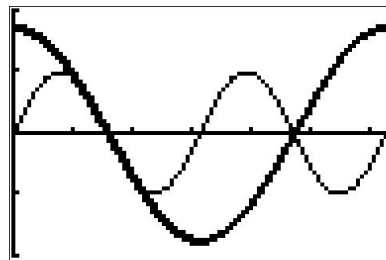

$y = \sin(2x)$ and $y = \sqrt{3}\cos(x)$

7. Unlike the previous problem, there seems to be no quick way to get the circular functions or their arguments to match in the equation $\sin(x)\cos\left(\frac{x}{2}\right) + \cos(x)\sin\left(\frac{x}{2}\right) = 1$. If we stare at it long enough, however, we realize that the left hand side is the expanded form of the sum formula for $\sin\left(x + \frac{x}{2}\right)$. Hence, our original equation is equivalent to $\sin\left(\frac{3}{2}x\right) = 1$. Solving, we find $x = \frac{\pi}{3} + \frac{4\pi}{3}k$ for integers k . Two of these solutions lie in $[0, 2\pi)$: $x = \frac{\pi}{3}$ and $x = \frac{5\pi}{3}$. Graphing $y = \sin(x)\cos\left(\frac{x}{2}\right) + \cos(x)\sin\left(\frac{x}{2}\right)$ and $y = 1$ validates our solutions.
8. With the absence of double angles or squares, there doesn't seem to be much we can do. However, since the arguments of the cosine and sine are the same, we can rewrite the left hand side of this equation as a sinusoid.⁹ To fit $f(x) = \cos(x) - \sqrt{3}\sin(x)$ to the form $A\sin(\omega t + \phi) + B$, we use what we learned in Example 8.5.3 and find $A = 2$, $B = 0$, $\omega = 1$ and $\phi = \frac{5\pi}{6}$. Hence, we can rewrite the equation $\cos(x) - \sqrt{3}\sin(x) = 2$ as $2\sin\left(x + \frac{5\pi}{6}\right) = 2$, or $\sin\left(x + \frac{5\pi}{6}\right) = 1$. Solving the latter, we get $x = -\frac{\pi}{3} + 2\pi k$ for integers k . Only one of these solutions, $x = \frac{5\pi}{3}$, which corresponds to $k = 1$, lies in $[0, 2\pi)$. Geometrically, we see that $y = \cos(x) - \sqrt{3}\sin(x)$ and $y = 2$ intersect just once, supporting our answer.

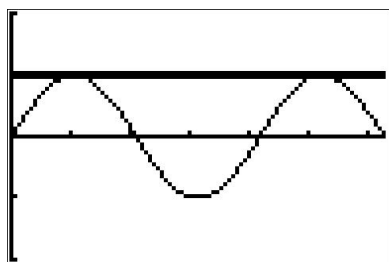

$y = \sin(x)\cos\left(\frac{x}{2}\right) + \cos(x)\sin\left(\frac{x}{2}\right)$ and $y = 1$

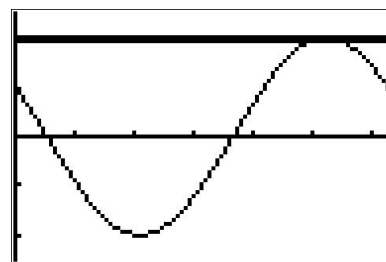

$y = \cos(x) - \sqrt{3}\sin(x)$ and $y = 2$

□

We repeat here the advice given when solving systems of nonlinear equations in section 7.2 – when it comes to solving equations involving the trigonometric functions, it helps to just try something.

⁹We are essentially ‘undoing’ the sum / difference formula for cosine or sine, depending on which form we use, so this problem is actually closely related to the previous one!

Next, we focus on solving inequalities involving the trigonometric functions. Since these functions are continuous on their domains, we may use the sign diagram technique we've used in the past to solve the inequalities.¹⁰

Example 8.7.3. Solve the following inequalities on $[0, 2\pi)$. Express your answers using interval notation and verify your answers graphically.

1. $2 \sin(x) \leq 1$

2. $\sin(2x) > \cos(x)$

3. $\tan(x) \geq 3$

Solution.

1. We begin solving $2 \sin(x) \leq 1$ by collecting all of the terms on one side of the equation and zero on the other to get $2 \sin(x) - 1 \leq 0$. Next, we let $f(x) = 2 \sin(x) - 1$ and note that our original inequality is equivalent to solving $f(x) \leq 0$. We now look to see where, if ever, f is undefined and where $f(x) = 0$. Since the domain of f is all real numbers, we can immediately set about finding the zeros of f . Solving $f(x) = 0$, we have $2 \sin(x) - 1 = 0$ or $\sin(x) = \frac{1}{2}$. The solutions here are $x = \frac{\pi}{6} + 2\pi k$ and $x = \frac{5\pi}{6} + 2\pi k$ for integers k . Since we are restricting our attention to $[0, 2\pi)$, only $x = \frac{\pi}{6}$ and $x = \frac{5\pi}{6}$ are of concern to us. Next, we choose test values in $[0, 2\pi)$ other than the zeros and determine if f is positive or negative there. For $x = 0$ we have $f(0) = -1$, for $x = \frac{\pi}{2}$ we get $f(\frac{\pi}{2}) = 1$ and for $x = \pi$ we get $f(\pi) = -1$. Since our original inequality is equivalent to $f(x) \leq 0$, we are looking for where the function is negative ($-$) or 0, and we get the intervals $[0, \frac{\pi}{6}] \cup [\frac{5\pi}{6}, 2\pi)$. We can confirm our answer graphically by seeing where the graph of $y = 2 \sin(x)$ crosses or is below the graph of $y = 1$.

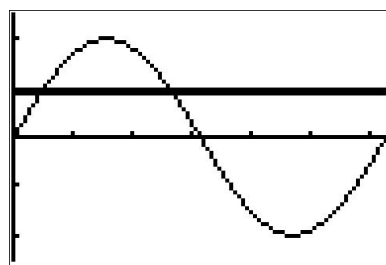
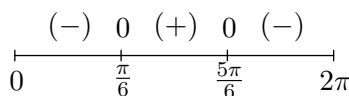

$y = 2 \sin(x)$ and $y = 1$

2. We first rewrite $\sin(2x) > \cos(x)$ as $\sin(2x) - \cos(x) > 0$ and let $f(x) = \sin(2x) - \cos(x)$. Our original inequality is thus equivalent to $f(x) > 0$. The domain of f is all real numbers, so we can advance to finding the zeros of f . Setting $f(x) = 0$ yields $\sin(2x) - \cos(x) = 0$, which, by way of the double angle identity for sine, becomes $2 \sin(x) \cos(x) - \cos(x) = 0$ or $\cos(x)(2 \sin(x) - 1) = 0$. From $\cos(x) = 0$, we get $x = \frac{\pi}{2} + \pi k$ for integers k of which only $x = \frac{\pi}{2}$ and $x = \frac{3\pi}{2}$ lie in $[0, 2\pi)$. For $2 \sin(x) - 1 = 0$, we get $\sin(x) = \frac{1}{2}$ which gives $x = \frac{\pi}{6} + 2\pi k$ or $x = \frac{5\pi}{6} + 2\pi k$ for integers k . Of those, only $x = \frac{\pi}{6}$ and $x = \frac{5\pi}{6}$ lie in $[0, 2\pi)$. Next, we choose

¹⁰See page 348, Example 3.1.5, page 455, page 533, Example 6.3.2 and Example 6.4.2 for discussion of this technique.

our test values. For $x = 0$ we find $f(0) = -1$; when $x = \frac{\pi}{4}$ we get $f\left(\frac{\pi}{4}\right) = 1 - \frac{\sqrt{2}}{2} = \frac{2-\sqrt{2}}{2}$; for $x = \frac{3\pi}{4}$ we get $f\left(\frac{3\pi}{4}\right) = -1 + \frac{\sqrt{2}}{2} = \frac{\sqrt{2}-2}{2}$; when $x = \pi$ we have $f(\pi) = 1$, and lastly, for $x = \frac{7\pi}{4}$ we get $f\left(\frac{7\pi}{4}\right) = -1 - \frac{\sqrt{2}}{2} = \frac{-2-\sqrt{2}}{2}$. We see $f(x) > 0$ on $\left(\frac{\pi}{6}, \frac{\pi}{2}\right) \cup \left(\frac{5\pi}{6}, \frac{3\pi}{2}\right)$, so this is our answer. We can use the calculator to check that the graph of $y = \sin(2x)$ is indeed above the graph of $y = \cos(x)$ on those intervals.

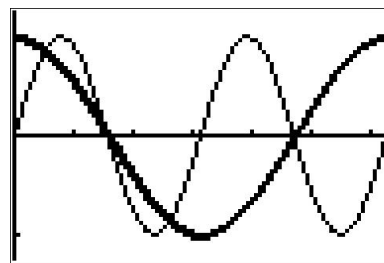
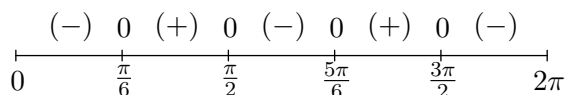

$y = \sin(2x)$ and $y = \cos(x)$

3. Proceeding as in the last two problems, we rewrite $\tan(x) \geq 3$ as $\tan(x) - 3 \geq 0$ and let $f(x) = \tan(x) - 3$. We note that on $[0, 2\pi)$, f is undefined at $x = \frac{\pi}{2}$ and $\frac{3\pi}{2}$, so those values will need the usual disclaimer on the sign diagram.¹¹ Moving along to zeros, solving $f(x) = \tan(x) - 3 = 0$ requires the arctangent function. We find $x = \arctan(3) + \pi k$ for integers k and of these, only $x = \arctan(3)$ and $x = \arctan(3) + \pi$ lie in $[0, 2\pi)$. Since $3 > 0$, we know $0 < \arctan(3) < \frac{\pi}{2}$ which allows us to position these zeros correctly on the sign diagram. To choose test values, we begin with $x = 0$ and find $f(0) = -3$. Finding a convenient test value in the interval $(\arctan(3), \frac{\pi}{2})$ is a bit more challenging. Keep in mind that the arctangent function is increasing and is bounded above by $\frac{\pi}{2}$. This means that the number $x = \arctan(117)$ is guaranteed¹² to lie between $\arctan(3)$ and $\frac{\pi}{2}$. We see that $f(\arctan(117)) = \tan(\arctan(117)) - 3 = 114$. For our next test value, we take $x = \pi$ and find $f(\pi) = -3$. To find our next test value, we note that since $\arctan(3) < \arctan(117) < \frac{\pi}{2}$, it follows¹³ that $\arctan(3) + \pi < \arctan(117) + \pi < \frac{3\pi}{2}$. Evaluating f at $x = \arctan(117) + \pi$ yields $f(\arctan(117) + \pi) = \tan(\arctan(117) + \pi) - 3 = \tan(\arctan(117)) - 3 = 114$. We choose our last test value to be $x = \frac{7\pi}{4}$ and find $f\left(\frac{7\pi}{4}\right) = -4$. Since we want $f(x) \geq 0$, we see that our answer is $[\arctan(3), \frac{\pi}{2}) \cup [\arctan(3) + \pi, \frac{3\pi}{2})$. Using the graphs of $y = \tan(x)$ and $y = 3$, we see when the graph of the former is above (or meets) the graph of the latter.

¹¹See page 455 for a discussion of the non-standard character known as the interrobang.

¹²We could have chosen any value $\arctan(t)$ where $t > 3$.

¹³... by adding π through the inequality ...

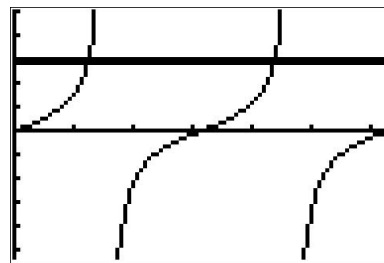
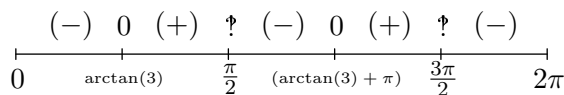

$$y = \tan(x) \text{ and } y = 3$$

□

Our next example puts solving equations and inequalities to good use – finding domains of functions.

Example 8.7.4. Express the domain of the following functions using extended interval notation.¹⁴

$$1. f(x) = \csc\left(2x + \frac{\pi}{3}\right) \qquad 2. f(x) = \frac{\sin(x)}{2\cos(x) - 1} \qquad 3. f(x) = \sqrt{1 - \cot(x)}$$

Solution.

1. To find the domain of $f(x) = \csc\left(2x + \frac{\pi}{3}\right)$, we rewrite f in terms of sine as $f(x) = \frac{1}{\sin\left(2x + \frac{\pi}{3}\right)}$. Since the sine function is defined everywhere, our only concern comes from zeros in the denominator. Solving $\sin\left(2x + \frac{\pi}{3}\right) = 0$, we get $x = -\frac{\pi}{6} + \frac{\pi}{2}k$ for integers k . In set-builder notation, our domain is $\{x : x \neq -\frac{\pi}{6} + \frac{\pi}{2}k \text{ for integers } k\}$. To help visualize the domain, we follow the old mantra ‘When in doubt, write it out!’ We get $\{x : x \neq -\frac{\pi}{6}, \frac{2\pi}{6}, -\frac{4\pi}{6}, \frac{5\pi}{6}, -\frac{7\pi}{6}, \frac{8\pi}{6}, \dots\}$, where we have kept the denominators 6 throughout to help see the pattern. Graphing the situation on a numberline, we have

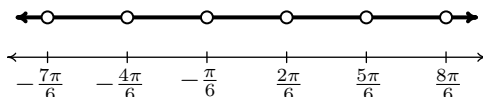

Proceeding as we did on page 724 in Section 8.3.1, we let x_k denote the k th number excluded from the domain and we have $x_k = -\frac{\pi}{6} + \frac{\pi}{2}k = \frac{(3k-1)\pi}{6}$ for integers k . The intervals which comprise the domain are of the form $(x_k, x_{k+1}) = \left(\frac{(3k-1)\pi}{6}, \frac{(3k+2)\pi}{6}\right)$ as k runs through the integers. Using extended interval notation, we have that the domain is

$$\bigcup_{k=-\infty}^{\infty} \left(\frac{(3k-1)\pi}{6}, \frac{(3k+2)\pi}{6} \right)$$

We can check our answer by substituting in values of k to see that it matches our diagram.

¹⁴See page 724 for details about this notation.

2. Since the domains of $\sin(x)$ and $\cos(x)$ are all real numbers, the only concern when finding the domain of $f(x) = \frac{\sin(x)}{2\cos(x)-1}$ is division by zero so we set the denominator equal to zero and solve. From $2\cos(x)-1=0$ we get $\cos(x) = \frac{1}{2}$ so that $x = \frac{\pi}{3} + 2\pi k$ or $x = \frac{5\pi}{3} + 2\pi k$ for integers k . Using set-builder notation, the domain is $\{x : x \neq \frac{\pi}{3} + 2\pi k \text{ and } x \neq \frac{5\pi}{3} + 2\pi k \text{ for integers } k\}$, or $\{x : x \neq \pm\frac{\pi}{3}, \pm\frac{5\pi}{3}, \pm\frac{7\pi}{3}, \pm\frac{11\pi}{3}, \dots\}$, so we have

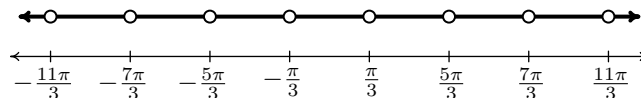

Unlike the previous example, we have *two* different families of points to consider, and we present two ways of dealing with this kind of situation. One way is to generalize what we did in the previous example and use the formulas we found in our domain work to describe the intervals. To that end, we let $a_k = \frac{\pi}{3} + 2\pi k = \frac{(6k+1)\pi}{3}$ and $b_k = \frac{5\pi}{3} + 2\pi k = \frac{(6k+5)\pi}{3}$ for integers k . The goal now is to write the domain in terms of the a 's and b 's. We find $a_0 = \frac{\pi}{3}$, $a_1 = \frac{7\pi}{3}$, $a_{-1} = -\frac{5\pi}{3}$, $a_2 = \frac{13\pi}{3}$, $a_{-2} = -\frac{11\pi}{3}$, $b_0 = \frac{5\pi}{3}$, $b_1 = \frac{11\pi}{3}$, $b_{-1} = -\frac{\pi}{3}$, $b_2 = \frac{17\pi}{3}$ and $b_{-2} = -\frac{7\pi}{3}$. Hence, in terms of the a 's and b 's, our domain is

$$\dots (a_{-2}, b_{-2}) \cup (b_{-2}, a_{-1}) \cup (a_{-1}, b_{-1}) \cup (b_{-1}, a_0) \cup (a_0, b_0) \cup (b_0, a_1) \cup (a_1, b_1) \cup \dots$$

If we group these intervals in pairs, $(a_{-2}, b_{-2}) \cup (b_{-2}, a_{-1})$, $(a_{-1}, b_{-1}) \cup (b_{-1}, a_0)$, $(a_0, b_0) \cup (b_0, a_1)$ and so forth, we see a pattern emerge of the form $(a_k, b_k) \cup (b_k, a_{k+1})$ for integers k so that our domain can be written as

$$\bigcup_{k=-\infty}^{\infty} (a_k, b_k) \cup (b_k, a_{k+1}) = \bigcup_{k=-\infty}^{\infty} \left(\frac{(6k+1)\pi}{3}, \frac{(6k+5)\pi}{3} \right) \cup \left(\frac{(6k+5)\pi}{3}, \frac{(6k+7)\pi}{3} \right)$$

A second approach to the problem exploits the periodic nature of f . Since $\cos(x)$ and $\sin(x)$ have period 2π , it's not too difficult to show the function f repeats itself every 2π units.¹⁵ This means if we can find a formula for the domain on an interval of length 2π , we can express the entire domain by translating our answer left and right on the x -axis by adding integer multiples of 2π . One such interval that arises from our domain work is $[\frac{\pi}{3}, \frac{7\pi}{3}]$. The portion of the domain here is $(\frac{\pi}{3}, \frac{5\pi}{3}) \cup (\frac{5\pi}{3}, \frac{7\pi}{3})$. Adding integer multiples of 2π , we get the family of intervals $(\frac{\pi}{3} + 2\pi k, \frac{5\pi}{3} + 2\pi k) \cup (\frac{5\pi}{3} + 2\pi k, \frac{7\pi}{3} + 2\pi k)$ for integers k . We leave it to the reader to show that getting common denominators leads to our previous answer.

¹⁵This doesn't necessarily mean the period of f is 2π . The tangent function is comprised of $\cos(x)$ and $\sin(x)$, but its period is half theirs. The reader is invited to investigate the period of f .

3. To find the domain of $f(x) = \sqrt{1 - \cot(x)}$, we first note that, due to the presence of the $\cot(x)$ term, $x \neq \pi k$ for integers k . Next, we recall that for the square root to be defined, we need $1 - \cot(x) \geq 0$. Unlike the inequalities we solved in Example 8.7.3, we are not restricted here to a given interval. Our strategy is to solve this inequality over $(0, \pi)$ (the same interval which generates a fundamental cycle of cotangent) and then add integer multiples of the period, in this case, π . We let $g(x) = 1 - \cot(x)$ and set about making a sign diagram for g over the interval $(0, \pi)$ to find where $g(x) \geq 0$. We note that g is undefined for $x = \pi k$ for integers k , in particular, at the endpoints of our interval $x = 0$ and $x = \pi$. Next, we look for the zeros of g . Solving $g(x) = 0$, we get $\cot(x) = 1$ or $x = \frac{\pi}{4} + \pi k$ for integers k and only one of these, $x = \frac{\pi}{4}$, lies in $(0, \pi)$. Choosing the test values $x = \frac{\pi}{6}$ and $x = \frac{\pi}{2}$, we get $g(\frac{\pi}{6}) = 1 - \sqrt{3}$, and $g(\frac{\pi}{2}) = 1$.

$$\begin{array}{ccccccc} & \text{?} & (-) & 0 & (+) & \text{?} & \\ & | & & | & & | & \\ & 0 & & \frac{\pi}{4} & & \pi & \end{array}$$

We find $g(x) \geq 0$ on $[\frac{\pi}{4}, \pi)$. Adding multiples of the period we get our solution to consist of the intervals $[\frac{\pi}{4} + \pi k, \pi + \pi k) = [\frac{(4k+1)\pi}{4}, (k+1)\pi)$. Using extended interval notation, we express our final answer as

$$\bigcup_{k=-\infty}^{\infty} \left[\frac{(4k+1)\pi}{4}, (k+1)\pi \right)$$

□

We close this section with an example which demonstrates how to solve equations and inequalities involving the inverse trigonometric functions.

Example 8.7.5. Solve the following equations and inequalities analytically. Check your answers using a graphing utility.

1. $\arcsin(2x) = \frac{\pi}{3}$
2. $4 \arccos(x) - 3\pi = 0$
3. $3 \operatorname{arcsec}(2x - 1) + \pi = 2\pi$
4. $4 \arctan^2(x) - 3\pi \arctan(x) - \pi^2 = 0$
5. $\pi^2 - 4 \arccos^2(x) < 0$
6. $4 \operatorname{arccot}(3x) > \pi$

Solution.

1. To solve $\arcsin(2x) = \frac{\pi}{3}$, we first note that $\frac{\pi}{3}$ is in the range of the arcsine function (so a solution exists!) Next, we exploit the inverse property of sine and arcsine from Theorem 8.26

$$\begin{aligned}\arcsin(2x) &= \frac{\pi}{3} \\ \sin(\arcsin(2x)) &= \sin\left(\frac{\pi}{3}\right) \\ 2x &= \frac{\sqrt{3}}{2} && \text{Since } \sin(\arcsin(u)) = u \\ x &= \frac{\sqrt{3}}{4}\end{aligned}$$

Graphing $y = \arcsin(2x)$ and the horizontal line $y = \frac{\pi}{3}$, we see they intersect at $\frac{\sqrt{3}}{4} \approx 0.4430$.

2. Our first step in solving $4 \arccos(x) - 3\pi = 0$ is to isolate the arccosine. Doing so, we get $\arccos(x) = \frac{3\pi}{4}$. Since $\frac{3\pi}{4}$ is in the range of arccosine, we may apply Theorem 8.26

$$\begin{aligned}\arccos(x) &= \frac{3\pi}{4} \\ \cos(\arccos(x)) &= \cos\left(\frac{3\pi}{4}\right) \\ x &= -\frac{\sqrt{2}}{2} && \text{Since } \cos(\arccos(u)) = u\end{aligned}$$

The calculator confirms $y = 4 \arccos(x) - 3\pi$ crosses $y = 0$ (the x -axis) at $-\frac{\sqrt{2}}{2} \approx -0.7071$.

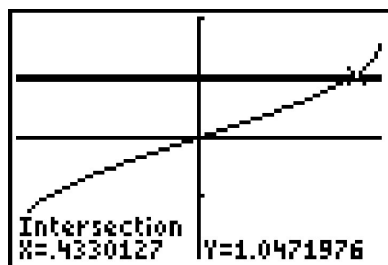

$$y = \arcsin(2x) \text{ and } y = \frac{\pi}{3}$$

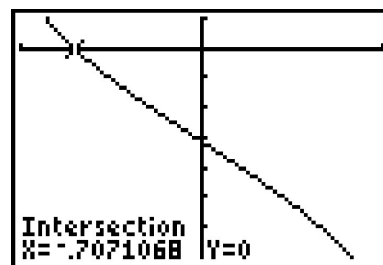

$$y = 4 \arccos(x) - 3\pi$$

3. From $3 \operatorname{arcsec}(2x - 1) + \pi = 2\pi$, we get $\operatorname{arcsec}(2x - 1) = \frac{\pi}{3}$. As we saw in Section 8.6, there are two possible ranges for the arcsecant function. Fortunately, both ranges contain $\frac{\pi}{3}$. Applying Theorem 8.28 / 8.29, we get

$$\begin{aligned}\operatorname{arcsec}(2x - 1) &= \frac{\pi}{3} \\ \sec(\operatorname{arcsec}(2x - 1)) &= \sec\left(\frac{\pi}{3}\right) \\ 2x - 1 &= 2 && \text{Since } \sec(\operatorname{arcsec}(u)) = u \\ x &= \frac{3}{2}\end{aligned}$$

To check using our calculator, we need to graph $y = 3 \operatorname{arcsec}(2x - 1) + \pi$. To do so, we make use of the identity $\operatorname{arcsec}(u) = \arccos\left(\frac{1}{u}\right)$ from Theorems 8.28 and 8.29.¹⁶ We see the graph of $y = 3 \arccos\left(\frac{1}{2x-1}\right) + \pi$ and the horizontal line $y = 2\pi$ intersect at $\frac{3}{2} = 1.5$.

¹⁶Since we are checking for solutions where arcsecant is positive, we know $u = 2x - 1 \geq 1$, and so the identity applies in both cases.

4. With the presence of both $\arctan^2(x)$ ($= (\arctan(x))^2$) and $\arctan(x)$, we substitute $u = \arctan(x)$. The equation $4\arctan^2(x) - 3\pi\arctan(x) - \pi^2 = 0$ becomes $4u^2 - 3\pi u - \pi^2 = 0$. Factoring,¹⁷ we get $(4u + \pi)(u - \pi) = 0$, so $u = \arctan(x) = -\frac{\pi}{4}$ or $u = \arctan(x) = \pi$. Since $-\frac{\pi}{4}$ is in the range of arctangent, but π is not, we only get solutions from the first equation. Using Theorem 8.27, we get

$$\begin{aligned}\arctan(x) &= -\frac{\pi}{4} \\ \tan(\arctan(x)) &= \tan\left(-\frac{\pi}{4}\right) \\ x &= -1 \quad \text{Since } \tan(\arctan(u)) = u.\end{aligned}$$

The calculator verifies our result.

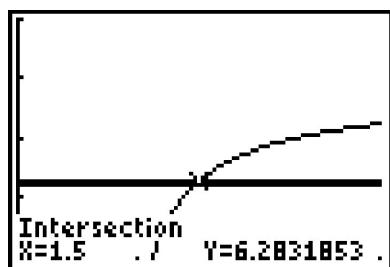

$$y = 3 \operatorname{arcsec}(2x - 1) + \pi \text{ and } y = 2\pi$$

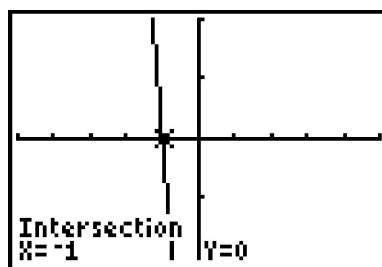

$$y = 4 \arctan^2(x) - 3\pi \arctan(x) - \pi^2$$

5. Since the inverse trigonometric functions are continuous on their domains, we can solve inequalities featuring these functions using sign diagrams. Since all of the nonzero terms of $\pi^2 - 4\arccos^2(x) < 0$ are on one side of the inequality, we let $f(x) = \pi^2 - 4\arccos^2(x)$ and note the domain of f is limited by the $\arccos(x)$ to $[-1, 1]$. Next, we find the zeros of f by setting $f(x) = \pi^2 - 4\arccos^2(x) = 0$. We get $\arccos(x) = \pm\frac{\pi}{2}$, and since the range of arccosine is $[0, \pi]$, we focus our attention on $\arccos(x) = \frac{\pi}{2}$. Using Theorem 8.26, we get $x = \cos\left(\frac{\pi}{2}\right) = 0$ as our only zero. Hence, we have two test intervals, $[-1, 0)$ and $(0, 1]$. Choosing test values $x = \pm 1$, we get $f(-1) = -3\pi^2 < 0$ and $f(1) = \pi^2 > 0$. Since we are looking for where $f(x) = \pi^2 - 4\arccos^2(x) < 0$, our answer is $[-1, 0)$. The calculator confirms that for these values of x , the graph of $y = \pi^2 - 4\arccos^2(x)$ is below $y = 0$ (the x -axis.)

¹⁷It's not as bad as it looks... don't let the π throw you!

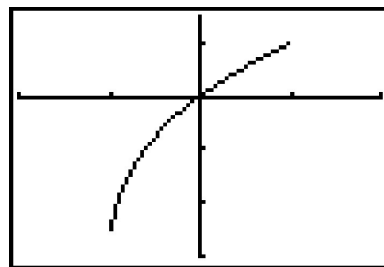
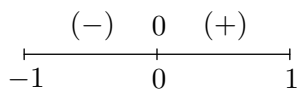

$$y = \pi^2 - 4 \arccos^2(x)$$

6. To begin, we rewrite $4 \operatorname{arccot}(3x) > \pi$ as $4 \operatorname{arccot}(3x) - \pi > 0$. We let $f(x) = 4 \operatorname{arccot}(3x) - \pi$, and note the domain of f is all real numbers, $(-\infty, \infty)$. To find the zeros of f , we set $f(x) = 4 \operatorname{arccot}(3x) - \pi = 0$ and solve. We get $\operatorname{arccot}(3x) = \frac{\pi}{4}$, and since $\frac{\pi}{4}$ is in the range of arccotangent, we may apply Theorem 8.27 and solve

$$\begin{aligned} \operatorname{arccot}(3x) &= \frac{\pi}{4} \\ \cot(\operatorname{arccot}(3x)) &= \cot\left(\frac{\pi}{4}\right) \\ 3x &= 1 && \text{Since } \cot(\operatorname{arccot}(u)) = u. \\ x &= \frac{1}{3} \end{aligned}$$

Next, we make a sign diagram for f . Since the domain of f is all real numbers, and there is only one zero of f , $x = \frac{1}{3}$, we have two test intervals, $(-\infty, \frac{1}{3})$ and $(\frac{1}{3}, \infty)$. Ideally, we wish to find test values x in these intervals so that $\operatorname{arccot}(4x)$ corresponds to one of our oft-used ‘common’ angles. After a bit of computation,¹⁸ we choose $x = 0$ for $x < \frac{1}{3}$ and for $x > \frac{1}{3}$, we choose $x = \frac{\sqrt{3}}{3}$. We find $f(0) = \pi > 0$ and $f\left(\frac{\sqrt{3}}{3}\right) = -\frac{\pi}{3} < 0$. Since we are looking for where $f(x) = 4 \operatorname{arccot}(3x) - \pi > 0$, we get our answer $(-\infty, \frac{1}{3})$. To check graphically, we use the technique in number 2c of Example 8.6.5 in Section 8.6 to graph $y = 4 \operatorname{arccot}(3x)$ and we see it is above the horizontal line $y = \pi$ on $(-\infty, \frac{1}{3}) = (-\infty, 0.\bar{3})$.

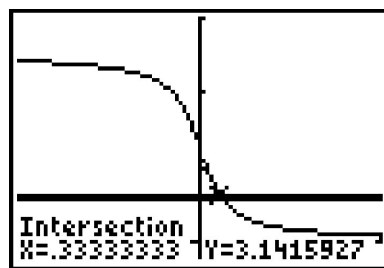
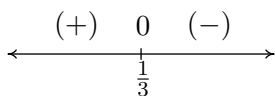

$$y = 4 \operatorname{arccot}(3x) \text{ and } y = \pi$$

□

¹⁸Set $3x$ equal to the cotangents of the ‘common angles’ and choose accordingly.

8.7.1 EXERCISES

In Exercises 1 - 18, find all of the exact solutions of the equation and then list those solutions which are in the interval $[0, 2\pi)$.

1. $\sin(5x) = 0$

2. $\cos(3x) = \frac{1}{2}$

3. $\sin(-2x) = \frac{\sqrt{3}}{2}$

4. $\tan(6x) = 1$

5. $\csc(4x) = -1$

6. $\sec(3x) = \sqrt{2}$

7. $\cot(2x) = -\frac{\sqrt{3}}{3}$

8. $\cos(9x) = 9$

9. $\sin\left(\frac{x}{3}\right) = \frac{\sqrt{2}}{2}$

10. $\cos\left(x + \frac{5\pi}{6}\right) = 0$

11. $\sin\left(2x - \frac{\pi}{3}\right) = -\frac{1}{2}$

12. $2\cos\left(x + \frac{7\pi}{4}\right) = \sqrt{3}$

13. $\csc(x) = 0$

14. $\tan(2x - \pi) = 1$

15. $\tan^2(x) = 3$

16. $\sec^2(x) = \frac{4}{3}$

17. $\cos^2(x) = \frac{1}{2}$

18. $\sin^2(x) = \frac{3}{4}$

In Exercises 19 - 42, solve the equation, giving the exact solutions which lie in $[0, 2\pi)$

19. $\sin(x) = \cos(x)$

20. $\sin(2x) = \sin(x)$

21. $\sin(2x) = \cos(x)$

22. $\cos(2x) = \sin(x)$

23. $\cos(2x) = \cos(x)$

24. $\cos(2x) = 2 - 5\cos(x)$

25. $3\cos(2x) + \cos(x) + 2 = 0$

26. $\cos(2x) = 5\sin(x) - 2$

27. $3\cos(2x) = \sin(x) + 2$

28. $2\sec^2(x) = 3 - \tan(x)$

29. $\tan^2(x) = 1 - \sec(x)$

30. $\cot^2(x) = 3\csc(x) - 3$

31. $\sec(x) = 2\csc(x)$

32. $\cos(x)\csc(x)\cot(x) = 6 - \cot^2(x)$

33. $\sin(2x) = \tan(x)$

34. $\cot^4(x) = 4\csc^2(x) - 7$

35. $\cos(2x) + \csc^2(x) = 0$

36. $\tan^3(x) = 3\tan(x)$

37. $\tan^2(x) = \frac{3}{2}\sec(x)$

38. $\cos^3(x) = -\cos(x)$

39. $\tan(2x) - 2\cos(x) = 0$

40. $\csc^3(x) + \csc^2(x) = 4\csc(x) + 4$

41. $2\tan(x) = 1 - \tan^2(x)$

42. $\tan(x) = \sec(x)$

In Exercises 43 - 58, solve the equation, giving the exact solutions which lie in $[0, 2\pi)$

43. $\sin(6x) \cos(x) = -\cos(6x) \sin(x)$

44. $\sin(3x) \cos(x) = \cos(3x) \sin(x)$

45. $\cos(2x) \cos(x) + \sin(2x) \sin(x) = 1$

46. $\cos(5x) \cos(3x) - \sin(5x) \sin(3x) = \frac{\sqrt{3}}{2}$

47. $\sin(x) + \cos(x) = 1$

48. $\sin(x) + \sqrt{3} \cos(x) = 1$

49. $\sqrt{2} \cos(x) - \sqrt{2} \sin(x) = 1$

50. $\sqrt{3} \sin(2x) + \cos(2x) = 1$

51. $\cos(2x) - \sqrt{3} \sin(2x) = \sqrt{2}$

52. $3\sqrt{3} \sin(3x) - 3 \cos(3x) = 3\sqrt{3}$

53. $\cos(3x) = \cos(5x)$

54. $\cos(4x) = \cos(2x)$

55. $\sin(5x) = \sin(3x)$

56. $\cos(5x) = -\cos(2x)$

57. $\sin(6x) + \sin(x) = 0$

58. $\tan(x) = \cos(x)$

In Exercises 59 - 68, solve the equation.

59. $\arccos(2x) = \pi$

60. $\pi - 2 \arcsin(x) = 2\pi$

61. $4 \arctan(3x - 1) - \pi = 0$

62. $6 \operatorname{arccot}(2x) - 5\pi = 0$

63. $4 \operatorname{arcsec}\left(\frac{x}{2}\right) = \pi$

64. $12 \operatorname{arccsc}\left(\frac{x}{3}\right) = 2\pi$

65. $9 \arcsin^2(x) - \pi^2 = 0$

66. $9 \operatorname{arccos}^2(x) - \pi^2 = 0$

67. $8 \operatorname{arccot}^2(x) + 3\pi^2 = 10\pi \operatorname{arccot}(x)$

68. $6 \arctan(x)^2 = \pi \arctan(x) + \pi^2$

In Exercises 69 - 80, solve the inequality. Express the exact answer in interval notation, restricting your attention to $0 \leq x \leq 2\pi$.

69. $\sin(x) \leq 0$

70. $\tan(x) \geq \sqrt{3}$

71. $\sec^2(x) \leq 4$

72. $\cos^2(x) > \frac{1}{2}$

73. $\cos(2x) \leq 0$

74. $\sin\left(x + \frac{\pi}{3}\right) > \frac{1}{2}$

75. $\cot^2(x) \geq \frac{1}{3}$

76. $2 \cos(x) \geq 1$

77. $\sin(5x) \geq 5$

78. $\cos(3x) \leq 1$

79. $\sec(x) \leq \sqrt{2}$

80. $\cot(x) \leq 4$

In Exercises 81 - 86, solve the inequality. Express the exact answer in interval notation, restricting your attention to $-\pi \leq x \leq \pi$.

81. $\cos(x) > \frac{\sqrt{3}}{2}$

82. $\sin(x) > \frac{1}{3}$

83. $\sec(x) \leq 2$

84. $\sin^2(x) < \frac{3}{4}$

85. $\cot(x) \geq -1$

86. $\cos(x) \geq \sin(x)$

In Exercises 87 - 92, solve the inequality. Express the exact answer in interval notation, restricting your attention to $-2\pi \leq x \leq 2\pi$.

87. $\csc(x) > 1$

88. $\cos(x) \leq \frac{5}{3}$

89. $\cot(x) \geq 5$

90. $\tan^2(x) \geq 1$

91. $\sin(2x) \geq \sin(x)$

92. $\cos(2x) \leq \sin(x)$

In Exercises 93 - 98, solve the given inequality.

93. $\arcsin(2x) > 0$

94. $3 \arccos(x) \leq \pi$

95. $6 \operatorname{arccot}(7x) \geq \pi$

96. $\pi > 2 \arctan(x)$

97. $2 \arcsin(x)^2 > \pi \arcsin(x)$

98. $12 \arccos(x)^2 + 2\pi^2 > 11\pi \arccos(x)$

In Exercises 99 - 107, express the domain of the function using the extended interval notation. (See page 724 in Section 8.3.1 for details.)

99. $f(x) = \frac{1}{\cos(x) - 1}$

100. $f(x) = \frac{\cos(x)}{\sin(x) + 1}$

101. $f(x) = \sqrt{\tan^2(x) - 1}$

102. $f(x) = \sqrt{2 - \sec(x)}$

103. $f(x) = \csc(2x)$

104. $f(x) = \frac{\sin(x)}{2 + \cos(x)}$

105. $f(x) = 3 \csc(x) + 4 \sec(x)$

106. $f(x) = \ln(|\cos(x)|)$

107. $f(x) = \arcsin(\tan(x))$

108. With the help of your classmates, determine the number of solutions to $\sin(x) = \frac{1}{2}$ in $[0, 2\pi)$. Then find the number of solutions to $\sin(2x) = \frac{1}{2}$, $\sin(3x) = \frac{1}{2}$ and $\sin(4x) = \frac{1}{2}$ in $[0, 2\pi)$. A pattern should emerge. Explain how this pattern would help you solve equations like $\sin(11x) = \frac{1}{2}$. Now consider $\sin\left(\frac{x}{2}\right) = \frac{1}{2}$, $\sin\left(\frac{3x}{2}\right) = \frac{1}{2}$ and $\sin\left(\frac{5x}{2}\right) = \frac{1}{2}$. What do you find? Replace $\frac{1}{2}$ with -1 and repeat the whole exploration.

8.7.2 ANSWERS

1. $x = \frac{\pi k}{5}; x = 0, \frac{\pi}{5}, \frac{2\pi}{5}, \frac{3\pi}{5}, \frac{4\pi}{5}, \pi, \frac{6\pi}{5}, \frac{7\pi}{5}, \frac{8\pi}{5}, \frac{9\pi}{5}$
2. $x = \frac{\pi}{9} + \frac{2\pi k}{3}$ or $x = \frac{5\pi}{9} + \frac{2\pi k}{3}; x = \frac{\pi}{9}, \frac{5\pi}{9}, \frac{7\pi}{9}, \frac{11\pi}{9}, \frac{13\pi}{9}, \frac{17\pi}{9}$
3. $x = \frac{2\pi}{3} + \pi k$ or $x = \frac{5\pi}{6} + \pi k; x = \frac{2\pi}{3}, \frac{5\pi}{6}, \frac{5\pi}{3}, \frac{11\pi}{6}$
4. $x = \frac{\pi}{24} + \frac{\pi k}{6}; x = \frac{\pi}{24}, \frac{5\pi}{24}, \frac{3\pi}{8}, \frac{13\pi}{24}, \frac{17\pi}{24}, \frac{7\pi}{8}, \frac{25\pi}{24}, \frac{29\pi}{24}, \frac{11\pi}{8}, \frac{37\pi}{24}, \frac{41\pi}{24}, \frac{15\pi}{8}$
5. $x = \frac{3\pi}{8} + \frac{\pi k}{2}; x = \frac{3\pi}{8}, \frac{7\pi}{8}, \frac{11\pi}{8}, \frac{15\pi}{8}$
6. $x = \frac{\pi}{12} + \frac{2\pi k}{3}$ or $x = \frac{7\pi}{12} + \frac{2\pi k}{3}; x = \frac{\pi}{12}, \frac{7\pi}{12}, \frac{3\pi}{4}, \frac{5\pi}{4}, \frac{17\pi}{12}, \frac{23\pi}{12}$
7. $x = \frac{\pi}{3} + \frac{\pi k}{2}; x = \frac{\pi}{3}, \frac{5\pi}{6}, \frac{4\pi}{3}, \frac{11\pi}{6}$
8. No solution
9. $x = \frac{3\pi}{4} + 6\pi k$ or $x = \frac{9\pi}{4} + 6\pi k; x = \frac{3\pi}{4}$
10. $x = -\frac{\pi}{3} + \pi k; x = \frac{2\pi}{3}, \frac{5\pi}{3}$
11. $x = \frac{3\pi}{4} + \pi k$ or $x = \frac{13\pi}{12} + \pi k; x = \frac{\pi}{12}, \frac{3\pi}{4}, \frac{13\pi}{12}, \frac{7\pi}{4}$
12. $x = -\frac{19\pi}{12} + 2\pi k$ or $x = \frac{\pi}{12} + 2\pi k; x = \frac{\pi}{12}, \frac{5\pi}{12}$
13. No solution
14. $x = \frac{5\pi}{8} + \frac{\pi k}{2}; x = \frac{\pi}{8}, \frac{5\pi}{8}, \frac{9\pi}{8}, \frac{13\pi}{8}$
15. $x = \frac{\pi}{3} + \pi k$ or $x = \frac{2\pi}{3} + \pi k; x = \frac{\pi}{3}, \frac{2\pi}{3}, \frac{4\pi}{3}, \frac{5\pi}{3}$
16. $x = \frac{\pi}{6} + \pi k$ or $x = \frac{5\pi}{6} + \pi k; x = \frac{\pi}{6}, \frac{5\pi}{6}, \frac{7\pi}{6}, \frac{11\pi}{6}$
17. $x = \frac{\pi}{4} + \frac{\pi k}{2}; x = \frac{\pi}{4}, \frac{3\pi}{4}, \frac{5\pi}{4}, \frac{7\pi}{4}$
18. $x = \frac{\pi}{3} + \pi k$ or $x = \frac{2\pi}{3} + \pi k; x = \frac{\pi}{3}, \frac{2\pi}{3}, \frac{4\pi}{3}, \frac{5\pi}{3}$

19. $x = \frac{\pi}{4}, \frac{5\pi}{4}$

21. $x = \frac{\pi}{6}, \frac{\pi}{2}, \frac{5\pi}{6}, \frac{3\pi}{2}$

23. $x = 0, \frac{2\pi}{3}, \frac{4\pi}{3}$

25. $x = \frac{2\pi}{3}, \frac{4\pi}{3}, \arccos\left(\frac{1}{3}\right), 2\pi - \arccos\left(\frac{1}{3}\right)$

27. $x = \frac{7\pi}{6}, \frac{11\pi}{6}, \arcsin\left(\frac{1}{3}\right), \pi - \arcsin\left(\frac{1}{3}\right)$

29. $x = 0, \frac{2\pi}{3}, \frac{4\pi}{3}$

31. $x = \arctan(2), \pi + \arctan(2)$

33. $x = 0, \pi, \frac{\pi}{4}, \frac{3\pi}{4}, \frac{5\pi}{4}, \frac{7\pi}{4}$

35. $x = \frac{\pi}{2}, \frac{3\pi}{2}$

37. $x = \frac{\pi}{3}, \frac{5\pi}{3}$

39. $x = \frac{\pi}{6}, \frac{\pi}{2}, \frac{5\pi}{6}, \frac{3\pi}{2}$

41. $x = \frac{\pi}{8}, \frac{5\pi}{8}, \frac{9\pi}{8}, \frac{13\pi}{8}$

43. $x = 0, \frac{\pi}{7}, \frac{2\pi}{7}, \frac{3\pi}{7}, \frac{4\pi}{7}, \frac{5\pi}{7}, \frac{6\pi}{7}, \pi, \frac{8\pi}{7}, \frac{9\pi}{7}, \frac{10\pi}{7}, \frac{11\pi}{7}, \frac{12\pi}{7}, \frac{13\pi}{7}$

44. $x = 0, \frac{\pi}{2}, \pi, \frac{3\pi}{2}$

46. $x = \frac{\pi}{48}, \frac{11\pi}{48}, \frac{13\pi}{48}, \frac{23\pi}{48}, \frac{25\pi}{48}, \frac{35\pi}{48}, \frac{37\pi}{48}, \frac{47\pi}{48}, \frac{49\pi}{48}, \frac{59\pi}{48}, \frac{61\pi}{48}, \frac{71\pi}{48}, \frac{73\pi}{48}, \frac{83\pi}{48}, \frac{85\pi}{48}, \frac{95\pi}{48}$

47. $x = 0, \frac{\pi}{2}$

49. $x = \frac{\pi}{12}, \frac{17\pi}{12}$

51. $x = \frac{17\pi}{24}, \frac{41\pi}{24}, \frac{23\pi}{24}, \frac{47\pi}{24}$

20. $x = 0, \frac{\pi}{3}, \pi, \frac{5\pi}{3}$

22. $x = \frac{\pi}{6}, \frac{5\pi}{6}, \frac{3\pi}{2}$

24. $x = \frac{\pi}{3}, \frac{5\pi}{3}$

26. $x = \frac{\pi}{6}, \frac{5\pi}{6}$

28. $x = \frac{3\pi}{4}, \frac{7\pi}{4}, \arctan\left(\frac{1}{2}\right), \pi + \arctan\left(\frac{1}{2}\right)$

30. $x = \frac{\pi}{6}, \frac{5\pi}{6}, \frac{\pi}{2}$

32. $x = \frac{\pi}{6}, \frac{7\pi}{6}, \frac{5\pi}{6}, \frac{11\pi}{6}$

34. $x = \frac{\pi}{6}, \frac{\pi}{4}, \frac{3\pi}{4}, \frac{5\pi}{6}, \frac{7\pi}{6}, \frac{5\pi}{4}, \frac{7\pi}{4}, \frac{11\pi}{6}$

36. $x = 0, \frac{\pi}{3}, \frac{2\pi}{3}, \pi, \frac{4\pi}{3}, \frac{5\pi}{3}$

38. $x = \frac{\pi}{2}, \frac{3\pi}{2}$

40. $x = \frac{\pi}{6}, \frac{5\pi}{6}, \frac{7\pi}{6}, \frac{3\pi}{2}, \frac{11\pi}{6}$

42. No solution

45. $x = 0$

48. $x = \frac{\pi}{2}, \frac{11\pi}{6}$

50. $x = 0, \pi, \frac{\pi}{3}, \frac{4\pi}{3}$

52. $x = \frac{\pi}{6}, \frac{5\pi}{18}, \frac{5\pi}{6}, \frac{17\pi}{18}, \frac{3\pi}{2}, \frac{29\pi}{18}$

53. $x = 0, \frac{\pi}{4}, \frac{\pi}{2}, \frac{3\pi}{4}, \pi, \frac{5\pi}{4}, \frac{3\pi}{2}, \frac{7\pi}{4}$

54. $x = 0, \frac{\pi}{3}, \frac{2\pi}{3}, \pi, \frac{4\pi}{3}, \frac{5\pi}{3}$

55. $x = 0, \frac{\pi}{8}, \frac{3\pi}{8}, \frac{5\pi}{8}, \frac{7\pi}{8}, \pi, \frac{9\pi}{8}, \frac{11\pi}{8}, \frac{13\pi}{8}, \frac{15\pi}{8}$

56. $x = \frac{\pi}{7}, \frac{\pi}{3}, \frac{3\pi}{7}, \frac{5\pi}{7}, \pi, \frac{9\pi}{7}, \frac{11\pi}{7}, \frac{5\pi}{3}, \frac{13\pi}{7}$

57. $x = 0, \frac{2\pi}{7}, \frac{4\pi}{7}, \frac{6\pi}{7}, \frac{8\pi}{7}, \frac{10\pi}{7}, \frac{12\pi}{7}, \frac{\pi}{5}, \frac{3\pi}{5}, \pi, \frac{7\pi}{5}, \frac{9\pi}{5}$

58. $x = \arcsin\left(\frac{-1 + \sqrt{5}}{2}\right) \approx 0.6662, \pi - \arcsin\left(\frac{-1 + \sqrt{5}}{2}\right) \approx 2.4754$

59. $x = -\frac{1}{2}$

60. $x = -1$

61. $x = \frac{2}{3}$

62. $x = -\frac{\sqrt{3}}{2}$

63. $x = 2\sqrt{2}$

64. $x = 6$

65. $x = \pm \frac{\sqrt{3}}{2}$

66. $x = \frac{1}{2}$

67. $x = -1, 0$

68. $x = -\sqrt{3}$

69. $[\pi, 2\pi]$

70. $\left[\frac{\pi}{3}, \frac{\pi}{2}\right) \cup \left[\frac{4\pi}{3}, \frac{3\pi}{2}\right)$

71. $\left[0, \frac{\pi}{3}\right] \cup \left[\frac{2\pi}{3}, \frac{4\pi}{3}\right] \cup \left[\frac{5\pi}{3}, 2\pi\right]$

72. $\left[0, \frac{\pi}{4}\right) \cup \left(\frac{3\pi}{4}, \frac{5\pi}{4}\right) \cup \left(\frac{7\pi}{4}, 2\pi\right]$

73. $\left[\frac{\pi}{4}, \frac{3\pi}{4}\right] \cup \left[\frac{5\pi}{4}, \frac{7\pi}{4}\right]$

74. $\left[0, \frac{\pi}{2}\right) \cup \left(\frac{11\pi}{6}, 2\pi\right]$

75. $\left(0, \frac{\pi}{3}\right] \cup \left[\frac{2\pi}{3}, \pi\right) \cup \left(\pi, \frac{4\pi}{3}\right] \cup \left[\frac{5\pi}{3}, 2\pi\right)$

76. $\left[0, \frac{\pi}{3}\right] \cup \left[\frac{5\pi}{3}, 2\pi\right]$

77. No solution

78. $[0, 2\pi]$

79. $\left[0, \frac{\pi}{4}\right] \cup \left(\frac{\pi}{2}, \frac{3\pi}{2}\right) \cup \left[\frac{7\pi}{4}, 2\pi\right]$

80. $[\operatorname{arccot}(4), \pi) \cup [\pi + \operatorname{arccot}(4), 2\pi)$

81. $\left(-\frac{\pi}{6}, \frac{\pi}{6}\right)$

82. $\left(\arcsin\left(\frac{1}{3}\right), \pi - \arcsin\left(\frac{1}{3}\right)\right)$

83. $\left[-\pi, -\frac{\pi}{2}\right) \cup \left[-\frac{\pi}{3}, \frac{\pi}{3}\right] \cup \left(\frac{\pi}{2}, \pi\right)$

84. $\left(-\frac{2\pi}{3}, -\frac{\pi}{3}\right) \cup \left(\frac{\pi}{3}, \frac{2\pi}{3}\right)$

85. $\left(-\pi, -\frac{\pi}{4}\right] \cup \left(0, \frac{3\pi}{4}\right]$

86. $\left[-\frac{3\pi}{4}, \frac{\pi}{4}\right]$

87. $\left(-2\pi, -\frac{3\pi}{2}\right) \cup \left(-\frac{3\pi}{2}, -\pi\right) \cup \left(0, \frac{\pi}{2}\right) \cup \left(\frac{\pi}{2}, \pi\right)$

88. $[-2\pi, 2\pi]$

89. $(-2\pi, \operatorname{arccot}(5) - 2\pi] \cup (-\pi, \operatorname{arccot}(5) - \pi] \cup (0, \operatorname{arccot}(5)] \cup (\pi, \pi + \operatorname{arccot}(5))$

90. $\left[-\frac{7\pi}{4}, -\frac{3\pi}{2}\right) \cup \left(-\frac{3\pi}{2}, -\frac{5\pi}{4}\right] \cup \left[-\frac{3\pi}{4}, -\frac{\pi}{2}\right) \cup \left(-\frac{\pi}{2}, -\frac{\pi}{4}\right] \cup \left[\frac{\pi}{4}, \frac{\pi}{2}\right) \cup \left(\frac{\pi}{2}, \frac{3\pi}{4}\right] \cup \left[\frac{5\pi}{4}, \frac{3\pi}{2}\right) \cup \left(\frac{3\pi}{2}, \frac{7\pi}{4}\right]$

91. $\left[-2\pi, -\frac{5\pi}{3}\right] \cup \left[-\pi, -\frac{\pi}{3}\right] \cup \left[0, \frac{\pi}{3}\right] \cup \left[\pi, \frac{5\pi}{3}\right]$

92. $\left[-\frac{11\pi}{6}, -\frac{7\pi}{6}\right] \cup \left[\frac{\pi}{6}, \frac{5\pi}{6}\right] \cup \left\{-\frac{\pi}{2}, \frac{3\pi}{2}\right\}$

93. $\left(0, \frac{1}{2}\right]$

94. $\left[\frac{1}{2}, 1\right]$

95. $\left(-\infty, \frac{\sqrt{3}}{7}\right]$

96. $(-\infty, \infty)$

97. $[-1, 0)$

98. $\left[-1, -\frac{1}{2}\right) \cup \left(\frac{\sqrt{2}}{2}, 1\right]$

99. $\bigcup_{k=-\infty}^{\infty} (2k\pi, (2k+2)\pi)$

100. $\bigcup_{k=-\infty}^{\infty} \left(\frac{(4k-1)\pi}{2}, \frac{(4k+3)\pi}{2}\right)$

101. $\bigcup_{k=-\infty}^{\infty} \left\{ \left[\frac{(4k+1)\pi}{4}, \frac{(2k+1)\pi}{2} \right) \cup \left(\frac{(2k+1)\pi}{2}, \frac{(4k+3)\pi}{4} \right] \right\}$

102. $\bigcup_{k=-\infty}^{\infty} \left\{ \left[\frac{(6k-1)\pi}{3}, \frac{(6k+1)\pi}{3} \right] \cup \left(\frac{(4k+1)\pi}{2}, \frac{(4k+3)\pi}{2} \right) \right\}$

103. $\bigcup_{k=-\infty}^{\infty} \left(\frac{k\pi}{2}, \frac{(k+1)\pi}{2} \right)$

104. $(-\infty, \infty)$

105. $\bigcup_{k=-\infty}^{\infty} \left(\frac{k\pi}{2}, \frac{(k+1)\pi}{2} \right)$

106. $\bigcup_{k=-\infty}^{\infty} \left(\frac{(2k-1)\pi}{2}, \frac{(2k+1)\pi}{2} \right)$

107. $\bigcup_{k=-\infty}^{\infty} \left[\frac{(4k-1)\pi}{4}, \frac{(4k+1)\pi}{4} \right]$

CHAPTER 9

APPLICATIONS OF TRIGONOMETRY

9.1 APPLICATIONS OF SINUSOIDS

In the same way exponential functions can be used to model a wide variety of phenomena in nature,¹ the cosine and sine functions can be used to model their fair share of natural behaviors. In section 8.5, we introduced the concept of a sinusoid as a function which can be written either in the form $C(x) = A \cos(\omega x + \phi) + B$ for $\omega > 0$ or equivalently, in the form $S(x) = A \sin(\omega x + \phi) + B$ for $\omega > 0$. At the time, we remained undecided as to which form we preferred, but the time for such indecision is over. For clarity of exposition we focus on the sine function² in this section and switch to the independent variable t , since the applications in this section are time-dependent. We reintroduce and summarize all of the important facts and definitions about this form of the sinusoid below.

Properties of the Sinusoid $S(t) = A \sin(\omega t + \phi) + B$

- The **amplitude** is $|A|$
- The **angular frequency** is ω and the **ordinary frequency** is $f = \frac{\omega}{2\pi}$
- The **period** is $T = \frac{1}{f} = \frac{2\pi}{\omega}$
- The **phase** is ϕ and the **phase shift** is $-\frac{\phi}{\omega}$
- The **vertical shift** or **baseline** is B

Along with knowing these formulas, it is helpful to remember what these quantities mean in context. The amplitude measures the maximum displacement of the sine wave from its baseline (determined by the vertical shift), the period is the length of time it takes to complete one cycle of the sinusoid, the angular frequency tells how many cycles are completed over an interval of length 2π , and the ordinary frequency measures how many cycles occur per unit of time. The phase indicates what

¹See Section 6.5.

²Sine haters can use the co-function identity $\cos\left(\frac{\pi}{2} - \theta\right) = \sin(\theta)$ to turn all of the sines into cosines.

angle ϕ corresponds to $t = 0$, and the phase shift represents how much of a ‘head start’ the sinusoid has over the un-shifted sine function. The figure below is repeated from Section 8.5.

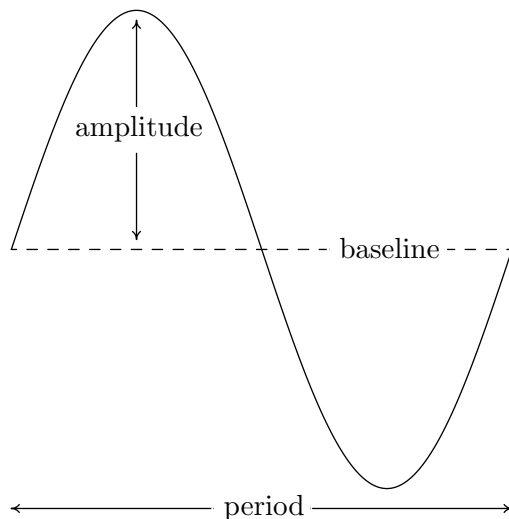

In Section 8.1.1, we introduced the concept of circular motion and in Section 8.2.1, we developed formulas for circular motion. Our first foray into sinusoidal motion puts these notions to good use.

Example 9.1.1. Recall from Exercise 55 in Section 8.1 that The Giant Wheel at Cedar Point is a circle with diameter 128 feet which sits on an 8 foot tall platform making its overall height 136 feet. It completes two revolutions in 2 minutes and 7 seconds. Assuming that the riders are at the edge of the circle, find a sinusoid which describes the height of the passengers above the ground t seconds after they pass the point on the wheel closest to the ground.

Solution. We sketch the problem situation below and assume a counter-clockwise rotation.³

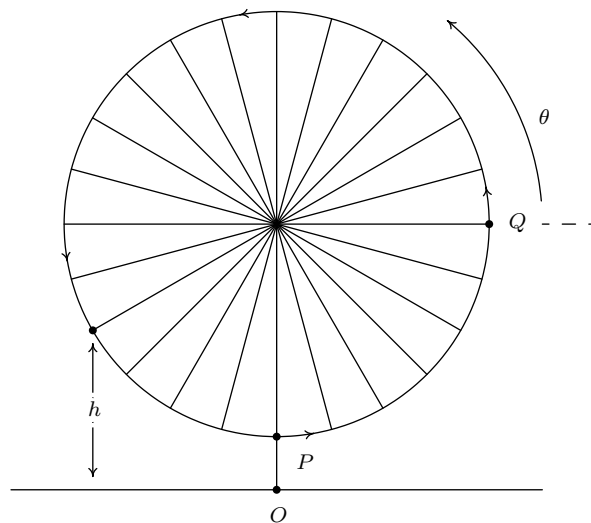

³Otherwise, we could just observe the motion of the wheel from the other side.

We know from the equations given on page 700 in Section 8.2.1 that the y -coordinate for counter-clockwise motion on a circle of radius r centered at the origin with constant angular velocity (frequency) ω is given by $y = r \sin(\omega t)$. Here, $t = 0$ corresponds to the point $(r, 0)$ so that θ , the angle measuring the amount of rotation, is in standard position. In our case, the diameter of the wheel is 128 feet, so the radius is $r = 64$ feet. Since the wheel completes two revolutions in 2 minutes and 7 seconds (which is 127 seconds) the period $T = \frac{1}{2}(127) = \frac{127}{2}$ seconds. Hence, the angular frequency is $\omega = \frac{2\pi}{T} = \frac{4\pi}{127}$ radians per second. Putting these two pieces of information together, we have that $y = 64 \sin\left(\frac{4\pi}{127}t\right)$ describes the y -coordinate on the Giant Wheel after t seconds, assuming it is centered at $(0, 0)$ with $t = 0$ corresponding to the point Q . In order to find an expression for h , we take the point O in the figure as the origin. Since the base of the Giant Wheel ride is 8 feet above the ground and the Giant Wheel itself has a radius of 64 feet, its center is 72 feet above the ground. To account for this vertical shift upward,⁴ we add 72 to our formula for y to obtain the new formula $h = y + 72 = 64 \sin\left(\frac{4\pi}{127}t\right) + 72$. Next, we need to adjust things so that $t = 0$ corresponds to the point P instead of the point Q . This is where the phase comes into play. Geometrically, we need to shift the angle θ in the figure back $\frac{\pi}{2}$ radians. From Section 8.2.1, we know $\theta = \omega t = \frac{4\pi}{127}t$, so we (temporarily) write the height in terms of θ as $h = 64 \sin(\theta) + 72$. Subtracting $\frac{\pi}{2}$ from θ gives the final answer $h(t) = 64 \sin\left(\theta - \frac{\pi}{2}\right) + 72 = 64 \sin\left(\frac{4\pi}{127}t - \frac{\pi}{2}\right) + 72$. We can check the reasonableness of our answer by graphing $y = h(t)$ over the interval $\left[0, \frac{127}{2}\right]$.

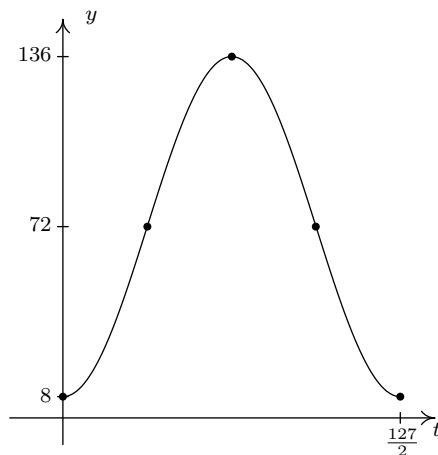

□

A few remarks about Example 9.1.1 are in order. First, note that the amplitude of 64 in our answer corresponds to the radius of the Giant Wheel. This means that passengers on the Giant Wheel never stray more than 64 feet vertically from the center of the Wheel, which makes sense. Second, the phase shift of our answer works out to be $\frac{\pi/2}{4\pi/127} = \frac{127}{8} = 15.875$. This represents the ‘time delay’ (in seconds) we introduce by starting the motion at the point P as opposed to the point Q . Said differently, passengers which ‘start’ at P take 15.875 seconds to ‘catch up’ to the point Q .

Our next example revisits the daylight data first introduced in Section 2.5, Exercise 6b.

⁴We are readjusting our ‘baseline’ from $y = 0$ to $y = 72$.

Example 9.1.2. According to the [U.S. Naval Observatory](#) website, the number of hours H of daylight that Fairbanks, Alaska received on the 21st day of the n th month of 2009 is given below. Here $t = 1$ represents January 21, 2009, $t = 2$ represents February 21, 2009, and so on.

Month Number	1	2	3	4	5	6	7	8	9	10	11	12
Hours of Daylight	5.8	9.3	12.4	15.9	19.4	21.8	19.4	15.6	12.4	9.1	5.6	3.3

1. Find a sinusoid which models these data and use a graphing utility to graph your answer along with the data.
2. Compare your answer to part 1 to one obtained using the regression feature of a calculator.

Solution.

1. To get a feel for the data, we plot it below.

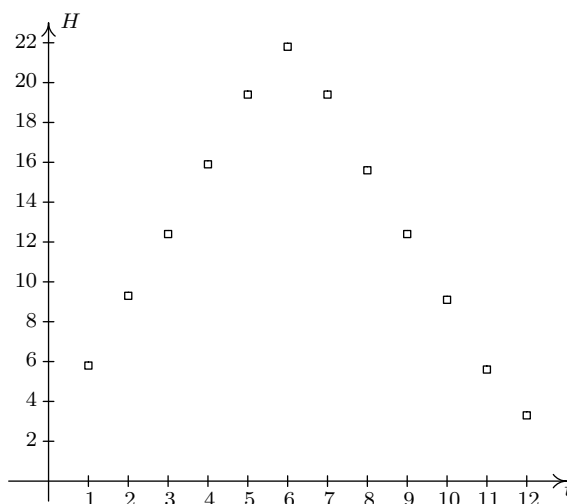

The data certainly appear sinusoidal,⁵ but when it comes down to it, fitting a sinusoid to data manually is not an exact science. We do our best to find the constants A , ω , ϕ and B so that the function $H(t) = A \sin(\omega t + \phi) + B$ closely matches the data. We first go after the vertical shift B whose value determines the baseline. In a typical sinusoid, the value of B is the average of the maximum and minimum values. So here we take $B = \frac{3.3+21.8}{2} = 12.55$. Next is the amplitude A which is the displacement from the baseline to the maximum (and minimum) values. We find $A = 21.8 - 12.55 = 12.55 - 3.3 = 9.25$. At this point, we have $H(t) = 9.25 \sin(\omega t + \phi) + 12.55$. Next, we go after the angular frequency ω . Since the data collected is over the span of a year (12 months), we take the period $T = 12$ months.⁶ This

⁵Okay, it appears to be the ‘Λ’ shape we saw in some of the graphs in Section 2.2. Just humor us.

⁶Even though the data collected lies in the interval $[1, 12]$, which has a length of 11, we need to think of the data point at $t = 1$ as a representative sample of the amount of daylight for every day in January. That is, it represents $H(t)$ over the interval $[0, 1]$. Similarly, $t = 2$ is a sample of $H(t)$ over $[1, 2]$, and so forth.

means $\omega = \frac{2\pi}{T} = \frac{2\pi}{12} = \frac{\pi}{6}$. The last quantity to find is the phase ϕ . Unlike the previous example, it is easier in this case to find the phase shift $-\frac{\phi}{\omega}$. Since we picked $A > 0$, the phase shift corresponds to the first value of t with $H(t) = 12.55$ (the baseline value).⁷ Here, we choose $t = 3$, since its corresponding H value of 12.4 is closer to 12.55 than the next value, 15.9, which corresponds to $t = 4$. Hence, $-\frac{\phi}{\omega} = 3$, so $\phi = -3\omega = -3\left(\frac{\pi}{6}\right) = -\frac{\pi}{2}$. We have $H(t) = 9.25 \sin\left(\frac{\pi}{6}t - \frac{\pi}{2}\right) + 12.55$. Below is a graph of our data with the curve $y = H(t)$.

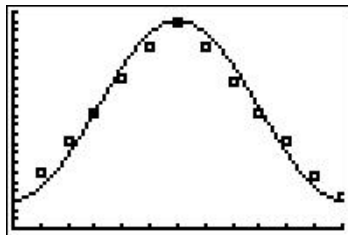

2. Using the ‘SinReg’ command, we graph the calculator’s regression below.

```

EDIT [2nd] [MODE] TESTS
8↑LinReg(a+bx)
9:LnReg
0:ExpReg
A:PwrReg
B:Logistic
 $\blacksquare$ :SinReg
0:Manual-Fit

```

```

SinReg
y=a*sin(bx+c)+d
a=8.364347567
b=.4966915558
c=-1.397237167
d=12.05954684

```

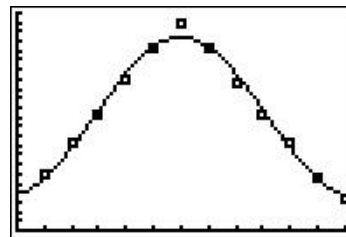

While both models seem to be reasonable fits to the data, the calculator model is possibly the better fit. The calculator does not give us an r^2 value like it did for linear regressions in Section 2.5, nor does it give us an R^2 value like it did for quadratic, cubic and quartic regressions as in Section 3.1. The reason for this, much like the reason for the absence of R^2 for the logistic model in Section 6.5, is beyond the scope of this course. We’ll just have to use our own good judgment when choosing the best sinusoid model. \square

9.1.1 HARMONIC MOTION

One of the major applications of sinusoids in Science and Engineering is the study of **harmonic motion**. The equations for harmonic motion can be used to describe a wide range of phenomena, from the motion of an object on a spring, to the response of an electronic circuit. In this subsection, we restrict our attention to modeling a simple spring system. Before we jump into the Mathematics, there are some Physics terms and concepts we need to discuss. In Physics, ‘mass’ is defined as a measure of an object’s resistance to straight-line motion whereas ‘weight’ is the amount of force (pull) gravity exerts on an object. An object’s mass cannot change,⁸ while its weight could change.

⁷See the figure on page 850.

⁸Well, assuming the object isn’t subjected to relativistic speeds ...

An object which weighs 6 pounds on the surface of the Earth would weigh 1 pound on the surface of the Moon, but its mass is the same in both places. In the English system of units, ‘pounds’ (lbs.) is a measure of force (weight), and the corresponding unit of mass is the ‘slug’. In the SI system, the unit of force is ‘Newtons’ (N) and the associated unit of mass is the ‘kilogram’ (kg). We convert between mass and weight using the formula⁹ $w = mg$. Here, w is the weight of the object, m is the mass and g is the acceleration due to gravity. In the English system, $g = 32 \frac{\text{feet}}{\text{second}^2}$, and in the SI system, $g = 9.8 \frac{\text{meters}}{\text{second}^2}$. Hence, on Earth a *mass* of 1 slug *weighs* 32 lbs. and a *mass* of 1 kg *weighs* 9.8 N.¹⁰ Suppose we attach an object with mass m to a spring as depicted below. The weight of the object will stretch the spring. The system is said to be in ‘equilibrium’ when the weight of the object is perfectly balanced with the restorative force of the spring. How far the spring stretches to reach equilibrium depends on the spring’s ‘spring constant’. Usually denoted by the letter k , the spring constant relates the force F applied to the spring to the amount d the spring stretches in accordance with [Hooke’s Law](#)¹¹ $F = kd$. If the object is released above or below the equilibrium position, or if the object is released with an upward or downward velocity, the object will bounce up and down on the end of the spring until some external force stops it. If we let $x(t)$ denote the object’s displacement from the equilibrium position at time t , then $x(t) = 0$ means the object is at the equilibrium position, $x(t) < 0$ means the object is *above* the equilibrium position, and $x(t) > 0$ means the object is *below* the equilibrium position. The function $x(t)$ is called the ‘equation of motion’ of the object.¹²

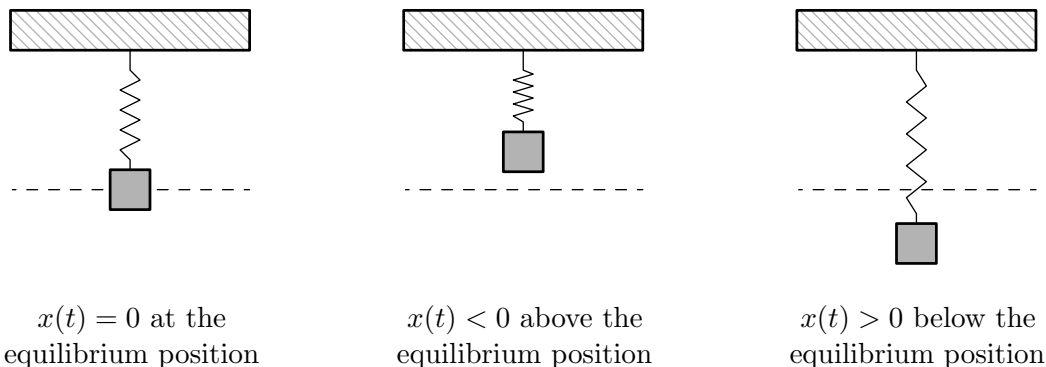

If we ignore all other influences on the system except gravity and the spring force, then Physics tells us that gravity and the spring force will battle each other forever and the object will oscillate indefinitely. In this case, we describe the motion as ‘free’ (meaning there is no external force causing the motion) and ‘undamped’ (meaning we ignore friction caused by surrounding medium, which in our case is air). The following theorem, which comes from Differential Equations, gives $x(t)$ as a function of the mass m of the object, the spring constant k , the initial displacement x_0 of the

⁹This is a consequence of Newton’s Second Law of Motion $F = ma$ where F is force, m is mass and a is acceleration. In our present setting, the force involved is weight which is caused by the acceleration due to gravity.

¹⁰Note that 1 pound = $1 \frac{\text{slug foot}}{\text{second}^2}$ and 1 Newton = $1 \frac{\text{kg meter}}{\text{second}^2}$.

¹¹Look familiar? We saw Hooke’s Law in Section 4.3.1.

¹²To keep units compatible, if we are using the English system, we use feet (ft.) to measure displacement. If we are in the SI system, we measure displacement in meters (m). Time is always measured in seconds (s).

object and initial velocity v_0 of the object. As with $x(t)$, $x_0 = 0$ means the object is released from the equilibrium position, $x_0 < 0$ means the object is released *above* the equilibrium position and $x_0 > 0$ means the object is released *below* the equilibrium position. As far as the initial velocity v_0 is concerned, $v_0 = 0$ means the object is released ‘from rest,’ $v_0 < 0$ means the object is heading *upwards* and $v_0 > 0$ means the object is heading *downwards*.¹³

Theorem 9.1. Equation for Free Undamped Harmonic Motion: Suppose an object of mass m is suspended from a spring with spring constant k . If the initial displacement from the equilibrium position is x_0 and the initial velocity of the object is v_0 , then the displacement x from the equilibrium position at time t is given by $x(t) = A \sin(\omega t + \phi)$ where

- $\omega = \sqrt{\frac{k}{m}}$ and $A = \sqrt{x_0^2 + \left(\frac{v_0}{\omega}\right)^2}$
- $A \sin(\phi) = x_0$ and $A\omega \cos(\phi) = v_0$.

It is a great exercise in ‘dimensional analysis’ to verify that the formulas given in Theorem 9.1 work out so that ω has units $\frac{1}{s}$ and A has units ft. or m, depending on which system we choose.

Example 9.1.3. Suppose an object weighing 64 pounds stretches a spring 8 feet.

1. If the object is attached to the spring and released 3 feet below the equilibrium position from rest, find the equation of motion of the object, $x(t)$. When does the object first pass through the equilibrium position? Is the object heading upwards or downwards at this instant?
2. If the object is attached to the spring and released 3 feet below the equilibrium position with an upward velocity of 8 feet per second, find the equation of motion of the object, $x(t)$. What is the longest distance the object travels *above* the equilibrium position? When does this first happen? Confirm your result using a graphing utility.

Solution. In order to use the formulas in Theorem 9.1, we first need to determine the spring constant k and the mass of the object m . To find k , we use Hooke’s Law $F = kd$. We know the object weighs 64 lbs. and stretches the spring 8 ft.. Using $F = 64$ and $d = 8$, we get $64 = k \cdot 8$, or $k = 8 \frac{\text{lbs.}}{\text{ft.}}$. To find m , we use $w = mg$ with $w = 64$ lbs. and $g = 32 \frac{\text{ft.}}{s^2}$. We get $m = 2$ slugs. We can now proceed to apply Theorem 9.1.

1. With $k = 8$ and $m = 2$, we get $\omega = \sqrt{\frac{k}{m}} = \sqrt{\frac{8}{2}} = 2$. We are told that the object is released 3 feet *below* the equilibrium position ‘from rest.’ This means $x_0 = 3$ and $v_0 = 0$. Therefore, $A = \sqrt{x_0^2 + \left(\frac{v_0}{\omega}\right)^2} = \sqrt{3^2 + 0^2} = 3$. To determine the phase ϕ , we have $A \sin(\phi) = x_0$, which in this case gives $3 \sin(\phi) = 3$ so $\sin(\phi) = 1$. Only $\phi = \frac{\pi}{2}$ and angles coterminal to it

¹³The sign conventions here are carried over from Physics. If not for the spring, the object would fall towards the ground, which is the ‘natural’ or ‘positive’ direction. Since the spring force acts in direct opposition to gravity, any movement upwards is considered ‘negative’.

satisfy this condition, so we pick¹⁴ the phase to be $\phi = \frac{\pi}{2}$. Hence, the equation of motion is $x(t) = 3 \sin(2t + \frac{\pi}{2})$. To find when the object passes through the equilibrium position we solve $x(t) = 3 \sin(2t + \frac{\pi}{2}) = 0$. Going through the usual analysis we find $t = -\frac{\pi}{4} + \frac{\pi}{2}k$ for integers k . Since we are interested in the first time the object passes through the equilibrium position, we look for the smallest positive t value which in this case is $t = \frac{\pi}{4} \approx 0.78$ seconds after the start of the motion. Common sense suggests that if we release the object below the equilibrium position, the object should be traveling upwards when it first passes through it. To check this answer, we graph one cycle of $x(t)$. Since our applied domain in this situation is $t \geq 0$, and the period of $x(t)$ is $T = \frac{2\pi}{\omega} = \frac{2\pi}{2} = \pi$, we graph $x(t)$ over the interval $[0, \pi]$. Remembering that $x(t) > 0$ means the object is below the equilibrium position and $x(t) < 0$ means the object is above the equilibrium position, the fact our graph is crossing through the t -axis from positive x to negative x at $t = \frac{\pi}{4}$ confirms our answer.

2. The only difference between this problem and the previous problem is that we now release the object with an upward velocity of $8 \frac{\text{ft}}{\text{s}}$. We still have $\omega = 2$ and $x_0 = 3$, but now we have $v_0 = -8$, the negative indicating the velocity is directed upwards. Here, we get $A = \sqrt{x_0^2 + (\frac{v_0}{\omega})^2} = \sqrt{3^2 + (-4)^2} = 5$. From $A \sin(\phi) = x_0$, we get $5 \sin(\phi) = 3$ which gives $\sin(\phi) = \frac{3}{5}$. From $A\omega \cos(\phi) = v_0$, we get $10 \cos(\phi) = -8$, or $\cos(\phi) = -\frac{4}{5}$. This means that ϕ is a Quadrant II angle which we can describe in terms of either arcsine or arccosine. Since $x(t)$ is expressed in terms of sine, we choose to express $\phi = \pi - \arcsin(\frac{3}{5})$. Hence, $x(t) = 5 \sin(2t + [\pi - \arcsin(\frac{3}{5})])$. Since the amplitude of $x(t)$ is 5, the object will travel at most 5 feet above the equilibrium position. To find when this happens, we solve the equation $x(t) = 5 \sin(2t + [\pi - \arcsin(\frac{3}{5})]) = -5$, the negative once again signifying that the object is *above* the equilibrium position. Going through the usual machinations, we get $t = \frac{1}{2} \arcsin(\frac{3}{5}) + \frac{\pi}{4} + \pi k$ for integers k . The smallest of these values occurs when $k = 0$, that is, $t = \frac{1}{2} \arcsin(\frac{3}{5}) + \frac{\pi}{4} \approx 1.107$ seconds after the start of the motion. To check our answer using the calculator, we graph $y = 5 \sin(2x + [\pi - \arcsin(\frac{3}{5})])$ on a graphing utility and confirm the coordinates of the first relative minimum to be approximately $(1.107, -5)$.

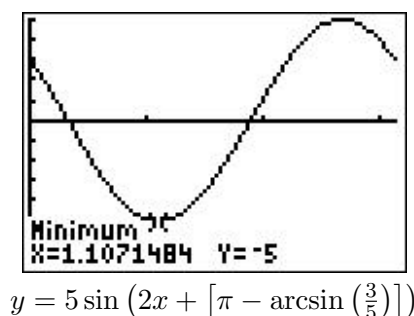
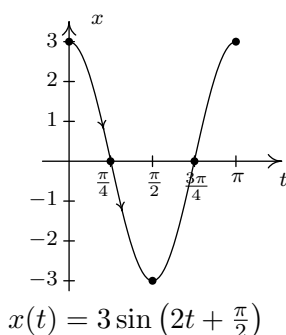

□

It is possible, though beyond the scope of this course, to model the effects of friction and other external forces acting on the system.¹⁵ While we may not have the Physics and Calculus background

¹⁴For confirmation, we note that $A\omega \cos(\phi) = v_0$, which in this case reduces to $6 \cos(\phi) = 0$.

¹⁵Take a good Differential Equations class to see this!

to *derive* equations of motion for these scenarios, we can certainly analyze them. We examine three cases in the following example.

Example 9.1.4.

1. Write $x(t) = 5e^{-t/5} \cos(t) + 5e^{-t/5} \sqrt{3} \sin(t)$ in the form $x(t) = A(t) \sin(\omega t + \phi)$. Graph $x(t)$ using a graphing utility.
2. Write $x(t) = (t + 3)\sqrt{2} \cos(2t) + (t + 3)\sqrt{2} \sin(2t)$ in the form $x(t) = A(t) \sin(\omega t + \phi)$. Graph $x(t)$ using a graphing utility.
3. Find the period of $x(t) = 5 \sin(6t) - 5 \sin(8t)$. Graph $x(t)$ using a graphing utility.

Solution.

1. We start rewriting $x(t) = 5e^{-t/5} \cos(t) + 5e^{-t/5} \sqrt{3} \sin(t)$ by factoring out $5e^{-t/5}$ from both terms to get $x(t) = 5e^{-t/5} (\cos(t) + \sqrt{3} \sin(t))$. We convert what's left in parentheses to the required form using the formulas introduced in Exercise 36 from Section 8.5. We find $(\cos(t) + \sqrt{3} \sin(t)) = 2 \sin(t + \frac{\pi}{3})$ so that $x(t) = 10e^{-t/5} \sin(t + \frac{\pi}{3})$. Graphing this on the calculator as $y = 10e^{-x/5} \sin(x + \frac{\pi}{3})$ reveals some interesting behavior. The sinusoidal nature continues indefinitely, but it is being attenuated. In the sinusoid $A \sin(\omega x + \phi)$, the coefficient A of the sine function is the amplitude. In the case of $y = 10e^{-x/5} \sin(x + \frac{\pi}{3})$, we can think of the *function* $A(x) = 10e^{-x/5}$ as the amplitude. As $x \rightarrow \infty$, $10e^{-x/5} \rightarrow 0$ which means the amplitude continues to shrink towards zero. Indeed, if we graph $y = \pm 10e^{-x/5}$ along with $y = 10e^{-x/5} \sin(x + \frac{\pi}{3})$, we see this attenuation taking place. This equation corresponds to the motion of an object on a spring where there is a slight force which acts to 'damp', or slow the motion. An example of this kind of force would be the friction of the object against the air. In this model, the object oscillates forever, but with smaller and smaller amplitude.

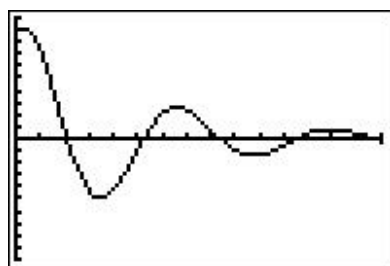

$$y = 10e^{-x/5} \sin\left(x + \frac{\pi}{3}\right)$$

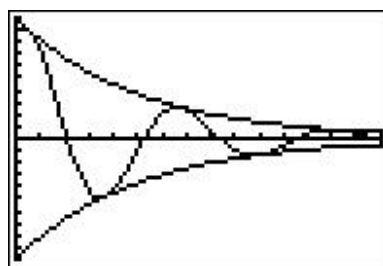

$$y = 10e^{-x/5} \sin\left(x + \frac{\pi}{3}\right), y = \pm 10e^{-x/5}$$

2. Proceeding as in the first example, we factor out $(t + 3)\sqrt{2}$ from each term in the function $x(t) = (t + 3)\sqrt{2} \cos(2t) + (t + 3)\sqrt{2} \sin(2t)$ to get $x(t) = (t + 3)\sqrt{2}(\cos(2t) + \sin(2t))$. We find $(\cos(2t) + \sin(2t)) = \sqrt{2} \sin(2t + \frac{\pi}{4})$, so $x(t) = 2(t + 3) \sin(2t + \frac{\pi}{4})$. Graphing this on the calculator as $y = 2(x + 3) \sin(2x + \frac{\pi}{4})$, we find the sinusoid's amplitude growing. Since our amplitude function here is $A(x) = 2(x + 3) = 2x + 6$, which continues to grow without bound

as $x \rightarrow \infty$, this is hardly surprising. The phenomenon illustrated here is ‘forced’ motion. That is, we imagine that the entire apparatus on which the spring is attached is oscillating as well. In this case, we are witnessing a ‘resonance’ effect – the frequency of the external oscillation matches the frequency of the motion of the object on the spring.¹⁶

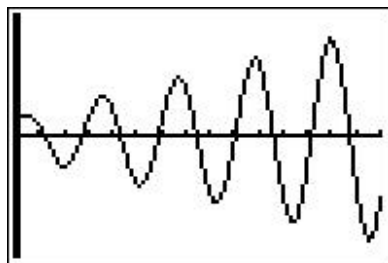

$$y = 2(x + 3) \sin\left(2x + \frac{\pi}{4}\right)$$

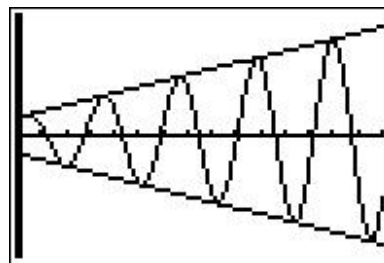

$$y = 2(x + 3) \sin\left(2x + \frac{\pi}{4}\right)$$

$$y = \pm 2(x + 3)$$

3. Last, but not least, we come to $x(t) = 5 \sin(6t) - 5 \sin(8t)$. To find the period of this function, we need to determine the length of the smallest interval on which both $f(t) = 5 \sin(6t)$ and $g(t) = 5 \sin(8t)$ complete a whole number of cycles. To do this, we take the ratio of their frequencies and reduce to lowest terms: $\frac{6}{8} = \frac{3}{4}$. This tells us that for every 3 cycles f makes, g makes 4. In other words, the period of $x(t)$ is three times the period of $f(t)$ (which is four times the period of $g(t)$), or π . We graph $y = 5 \sin(6x) - 5 \sin(8x)$ over $[0, \pi]$ on the calculator to check this. This equation of motion also results from ‘forced’ motion, but here the frequency of the external oscillation is different than that of the object on the spring. Since the sinusoids here have different frequencies, they are ‘out of sync’ and do not amplify each other as in the previous example. Taking things a step further, we can use a sum to product identity to rewrite $x(t) = 5 \sin(6t) - 5 \sin(8t)$ as $x(t) = -10 \sin(t) \cos(7t)$. The lower frequency factor in this expression, $-10 \sin(t)$, plays an interesting role in the graph of $x(t)$. Below we graph $y = 5 \sin(6x) - 5 \sin(8x)$ and $y = \pm 10 \sin(x)$ over $[0, 2\pi]$. This is an example of the ‘beat’ phenomena, and the curious reader is invited to explore this concept as well.¹⁷

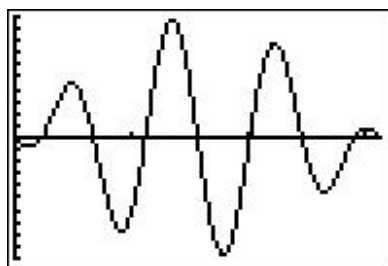

$$y = 5 \sin(6x) - 5 \sin(8x) \text{ over } [0, \pi]$$

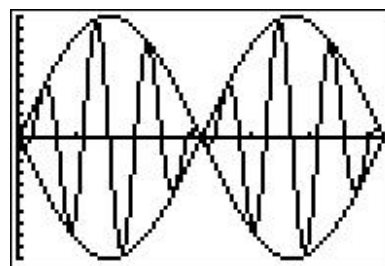

$$y = 5 \sin(6x) - 5 \sin(8x) \text{ and}$$

$$y = \pm 10 \sin(x) \text{ over } [0, 2\pi]$$

□

¹⁶The reader is invited to investigate the destructive implications of [resonance](#).

¹⁷A good place to start is this article on [beats](#).

9.1.2 EXERCISES

1. The sounds we hear are made up of mechanical waves. The note ‘A’ above the note ‘middle C’ is a sound wave with ordinary frequency $f = 440$ Hertz $= 440 \frac{\text{cycles}}{\text{second}}$. Find a sinusoid which models this note, assuming that the amplitude is 1 and the phase shift is 0.
2. The voltage V in an alternating current source has amplitude $220\sqrt{2}$ and ordinary frequency $f = 60$ Hertz. Find a sinusoid which models this voltage. Assume that the phase is 0.
3. The [London Eye](#) is a popular tourist attraction in London, England and is one of the largest Ferris Wheels in the world. It has a diameter of 135 meters and makes one revolution (counter-clockwise) every 30 minutes. It is constructed so that the lowest part of the Eye reaches ground level, enabling passengers to simply walk on to, and off of, the ride. Find a sinusoid which models the height h of the passenger above the ground in meters t minutes after they board the Eye at ground level.
4. On page 700 in Section 8.2.1, we found the x -coordinate of counter-clockwise motion on a circle of radius r with angular frequency ω to be $x = r \cos(\omega t)$, where $t = 0$ corresponds to the point $(r, 0)$. Suppose we are in the situation of Exercise 3 above. Find a sinusoid which models the horizontal *displacement* x of the passenger from the center of the Eye in meters t minutes after they board the Eye. Here we take $x(t) > 0$ to mean the passenger is to the *right* of the center, while $x(t) < 0$ means the passenger is to the *left* of the center.
5. In Exercise 52 in Section 8.1, we introduced the yo-yo trick ‘Around the World’ in which a yo-yo is thrown so it sweeps out a vertical circle. As in that exercise, suppose the yo-yo string is 28 inches and it completes one revolution in 3 seconds. If the closest the yo-yo ever gets to the ground is 2 inches, find a sinusoid which models the height h of the yo-yo above the ground in inches t seconds after it leaves its lowest point.
6. Suppose an object weighing 10 pounds is suspended from the ceiling by a spring which stretches 2 feet to its equilibrium position when the object is attached.
 - (a) Find the spring constant k in $\frac{\text{lbs.}}{\text{ft.}}$ and the mass of the object in slugs.
 - (b) Find the equation of motion of the object if it is released from 1 foot *below* the equilibrium position from rest. When is the first time the object passes through the equilibrium position? In which direction is it heading?
 - (c) Find the equation of motion of the object if it is released from 6 inches *above* the equilibrium position with a *downward* velocity of 2 feet per second. Find when the object passes through the equilibrium position heading downwards for the third time.

7. Consider the pendulum below. Ignoring air resistance, the angular displacement of the pendulum from the vertical position, θ , can be modeled as a sinusoid.¹⁸

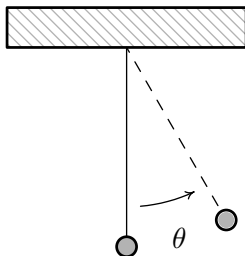

The amplitude of the sinusoid is the same as the initial angular displacement, θ_0 , of the pendulum and the period of the motion is given by

$$T = 2\pi\sqrt{\frac{l}{g}}$$

where l is the length of the pendulum and g is the acceleration due to gravity.

- (a) Find a sinusoid which gives the angular displacement θ as a function of time, t . Arrange things so $\theta(0) = \theta_0$.
- (b) In Exercise 40 section 5.3, you found the length of the pendulum needed in Jeff's antique Seth-Thomas clock to ensure the period of the pendulum is $\frac{1}{2}$ of a second. Assuming the initial displacement of the pendulum is 15° , find a sinusoid which models the displacement of the pendulum θ as a function of time, t , in seconds.
8. The table below lists the average temperature of Lake Erie as measured in Cleveland, Ohio on the first of the month for each month during the years 1971 – 2000.¹⁹ For example, $t = 3$ represents the average of the temperatures recorded for Lake Erie on every March 1 for the years 1971 through 2000.

Month Number, t	1	2	3	4	5	6	7	8	9	10	11	12
Temperature ($^\circ$ F), T	36	33	34	38	47	57	67	74	73	67	56	46

- (a) Using the techniques discussed in Example 9.1.2, fit a sinusoid to these data.
- (b) Using a graphing utility, graph your model along with the data set to judge the reasonableness of the fit.

¹⁸Provided θ is kept 'small.' Carl remembers the 'Rule of Thumb' as being 20° or less. Check with your friendly neighborhood physicist to make sure.

¹⁹See this website: <http://www.erh.noaa.gov/cle/climate/cle/normals/laketempcle.html>.

- (c) Use the model you found in part 8a to predict the average temperature recorded for Lake Erie on April 15th and September 15th during the years 1971–2000.²⁰
- (d) Compare your results to those obtained using a graphing utility.
9. The fraction of the moon illuminated at midnight Eastern Standard Time on the t^{th} day of June, 2009 is given in the table below.²¹

Day of June, t	3	6	9	12	15	18	21	24	27	30
Fraction Illuminated, F	0.81	0.98	0.98	0.83	0.57	0.27	0.04	0.03	0.26	0.58

- (a) Using the techniques discussed in Example 9.1.2, fit a sinusoid to these data.²²
- (b) Using a graphing utility, graph your model along with the data set to judge the reasonableness of the fit.
- (c) Use the model you found in part 9a to predict the fraction of the moon illuminated on June 1, 2009.²³
- (d) Compare your results to those obtained using a graphing utility.
10. With the help of your classmates, research the phenomena mentioned in Example 9.1.4, namely [resonance](#) and [beats](#).
11. With the help of your classmates, research [Amplitude Modulation](#) and [Frequency Modulation](#).
12. What other things in the world might be roughly sinusoidal? Look to see what models you can find for them and share your results with your class.

²⁰The computed average is 41°F for April 15th and 71°F for September 15th.

²¹See this website: <http://www.usno.navy.mil/USNO/astronomical-applications/data-services/frac-moon-ill>.

²²You may want to plot the data before you find the phase shift.

²³The listed fraction is 0.62.

9.1.3 ANSWERS

1. $S(t) = \sin(880\pi t)$
2. $V(t) = 220\sqrt{2}\sin(120\pi t)$
3. $h(t) = 67.5\sin\left(\frac{\pi}{15}t - \frac{\pi}{2}\right) + 67.5$
4. $x(t) = 67.5\cos\left(\frac{\pi}{15}t - \frac{\pi}{2}\right) = 67.5\sin\left(\frac{\pi}{15}t\right)$
5. $h(t) = 28\sin\left(\frac{2\pi}{3}t - \frac{\pi}{2}\right) + 30$
6. (a) $k = 5 \frac{\text{lbs.}}{\text{ft.}}$ and $m = \frac{5}{16}$ slugs
 (b) $x(t) = \sin\left(4t + \frac{\pi}{2}\right)$. The object first passes through the equilibrium point when $t = \frac{\pi}{8} \approx 0.39$ seconds after the motion starts. At this time, the object is heading upwards.
 (c) $x(t) = \frac{\sqrt{2}}{2}\sin\left(4t + \frac{7\pi}{4}\right)$. The object passes through the equilibrium point heading downwards for the third time when $t = \frac{17\pi}{16} \approx 3.34$ seconds.
7. (a) $\theta(t) = \theta_0 \sin\left(\sqrt{\frac{g}{l}}t + \frac{\pi}{2}\right)$
- (b) $\theta(t) = \frac{\pi}{12} \sin\left(4\pi t + \frac{\pi}{2}\right)$
8. (a) $T(t) = 20.5\sin\left(\frac{\pi}{6}t - \pi\right) + 53.5$
 (b) Our function and the data set are graphed below. The sinusoid seems to be shifted to the right of our data.

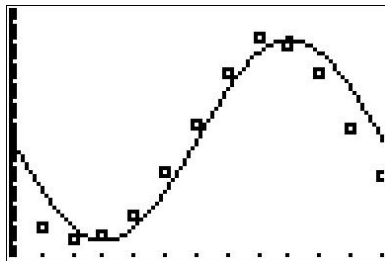

- (c) The average temperature on April 15th is approximately $T(4.5) \approx 39.00^\circ\text{F}$ and the average temperature on September 15th is approximately $T(9.5) \approx 73.38^\circ\text{F}$.
- (d) Using a graphing calculator, we get the following

```

SinReg
y=a*sin(bx+c)+d
a=20.8373989
b=.5251389217
c=-2.860348658
d=52.36580213
  
```

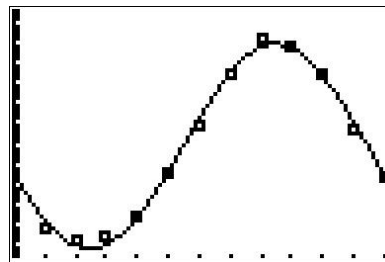

This model predicts the average temperature for April 15th to be approximately 42.43°F and the average temperature on September 15th to be approximately 70.05°F . This model appears to be more accurate.

9. (a) Based on the shape of the data, we either choose $A < 0$ or we find the *second* value of t which closely approximates the ‘baseline’ value, $F = 0.505$. We choose the latter to obtain $F(t) = 0.475 \sin\left(\frac{\pi}{15}t - 2\pi\right) + 0.505 = 0.475 \sin\left(\frac{\pi}{15}t\right) + 0.505$
- (b) Our function and the data set are graphed below. It’s a pretty good fit.

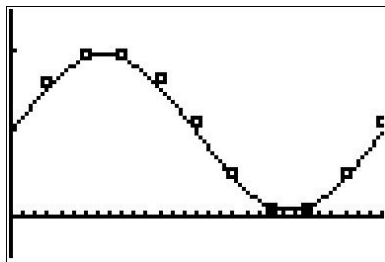

- (c) The fraction of the moon illuminated on June 1st, 2009 is approximately $F(1) \approx 0.60$
- (d) Using a graphing calculator, we get the following.

```
SinReg
y=a*sin(bx+c)+d
a=.495668493
b=.21448267
c=-.0985093289
d=.5315118883
```

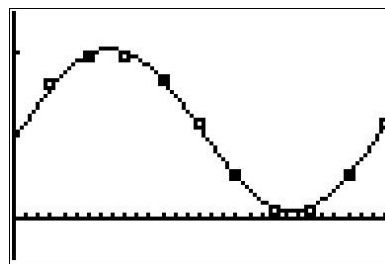

This model predicts that the fraction of the moon illuminated on June 1st, 2009 is approximately 0.59. This appears to be a better fit to the data than our first model.

9.2 THE LAW OF SINES

Trigonometry literally means ‘measuring triangles’ and with Chapter 8 under our belts, we are more than prepared to do just that. The main goal of this section and the next is to develop theorems which allow us to ‘solve’ triangles – that is, find the length of each side of a triangle and the measure of each of its angles. In Sections 8.2, 8.3 and 8.6, we’ve had some experience solving right triangles. The following example reviews what we know.

Example 9.2.1. Given a right triangle with a hypotenuse of length 7 units and one leg of length 4 units, find the length of the remaining side and the measures of the remaining angles. Express the angles in decimal degrees, rounded to the nearest hundredth of a degree.

Solution. For definitiveness, we label the triangle below.

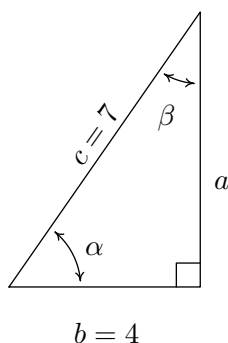

To find the length of the missing side a , we use the Pythagorean Theorem to get $a^2 + 4^2 = 7^2$ which then yields $a = \sqrt{33}$ units. Now that all three sides of the triangle are known, there are several ways we can find α using the inverse trigonometric functions. To decrease the chances of propagating error, however, we stick to using the data given to us in the problem. In this case, the lengths 4 and 7 were given, so we want to relate these to α . According to Theorem 8.4, $\cos(\alpha) = \frac{4}{7}$. Since α is an acute angle, $\alpha = \arccos\left(\frac{4}{7}\right)$ radians. Converting to degrees, we find $\alpha \approx 55.15^\circ$. Now that we have the measure of angle α , we could find the measure of angle β using the fact that α and β are complements so $\alpha + \beta = 90^\circ$. Once again, we opt to use the data given to us in the problem. According to Theorem 8.4, we have that $\sin(\beta) = \frac{4}{7}$ so $\beta = \arcsin\left(\frac{4}{7}\right)$ radians and we have $\beta \approx 34.85^\circ$. \square

A few remarks about Example 9.2.1 are in order. First, we adhere to the convention that a lower case Greek letter denotes an angle¹ and the corresponding lowercase English letter represents the side² opposite that angle. Thus, a is the side opposite α , b is the side opposite β and c is the side opposite γ . Taken together, the pairs (α, a) , (β, b) and (γ, c) are called *angle-side opposite pairs*. Second, as mentioned earlier, we will strive to solve for quantities using the original data given in the problem whenever possible. While this is not always the easiest or fastest way to proceed, it

¹as well as the measure of said angle

²as well as the length of said side

minimizes the chances of propagated error.³ Third, since many of the applications which require solving triangles ‘in the wild’ rely on degree measure, we shall adopt this convention for the time being.⁴ The Pythagorean Theorem along with Theorems 8.4 and 8.10 allow us to easily handle any given right triangle problem, but what if the triangle isn’t a right triangle? In certain cases, we can use the **Law of Sines** to help.

Theorem 9.2. The Law of Sines: Given a triangle with angle-side opposite pairs (α, a) , (β, b) and (γ, c) , the following ratios hold

$$\frac{\sin(\alpha)}{a} = \frac{\sin(\beta)}{b} = \frac{\sin(\gamma)}{c}$$

or, equivalently,

$$\frac{a}{\sin(\alpha)} = \frac{b}{\sin(\beta)} = \frac{c}{\sin(\gamma)}$$

The proof of the Law of Sines can be broken into three cases. For our first case, consider the triangle $\triangle ABC$ below, all of whose angles are acute, with angle-side opposite pairs (α, a) , (β, b) and (γ, c) . If we drop an altitude from vertex B , we divide the triangle into two right triangles: $\triangle ABQ$ and $\triangle BCQ$. If we call the length of the altitude h (for height), we get from Theorem 8.4 that $\sin(\alpha) = \frac{h}{c}$ and $\sin(\gamma) = \frac{h}{a}$ so that $h = c \sin(\alpha) = a \sin(\gamma)$. After some rearrangement of the last equation, we get $\frac{\sin(\alpha)}{a} = \frac{\sin(\gamma)}{c}$. If we drop an altitude from vertex A , we can proceed as above using the triangles $\triangle ABQ$ and $\triangle ACQ$ to get $\frac{\sin(\beta)}{b} = \frac{\sin(\gamma)}{c}$, completing the proof for this case.

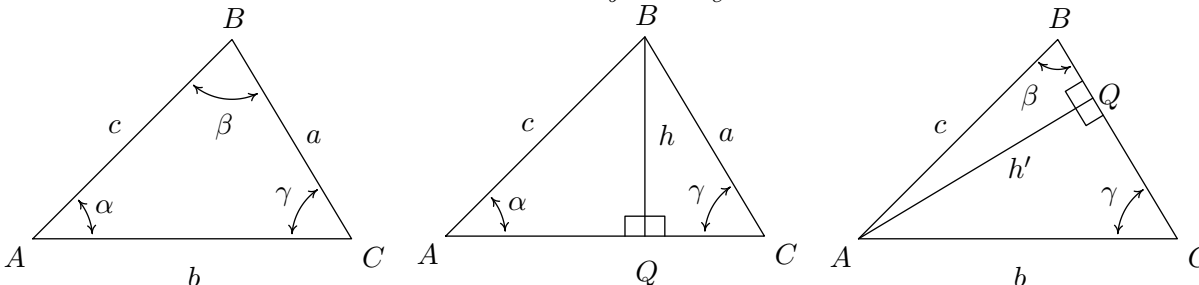

For our next case consider the triangle $\triangle ABC$ below with obtuse angle α . Extending an altitude from vertex A gives two right triangles, as in the previous case: $\triangle ABQ$ and $\triangle ACQ$. Proceeding as before, we get $h = b \sin(\gamma)$ and $h = c \sin(\beta)$ so that $\frac{\sin(\beta)}{b} = \frac{\sin(\gamma)}{c}$.

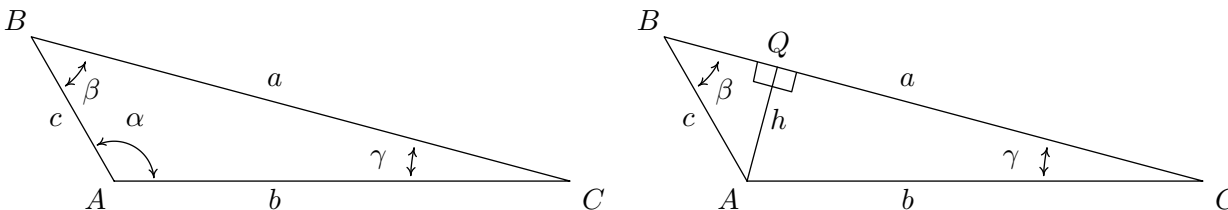

³Your Science teachers should thank us for this.

⁴Don't worry! Radians will be back before you know it!

Dropping an altitude from vertex B also generates two right triangles, $\triangle ABQ$ and $\triangle BCQ$. We know that $\sin(\alpha') = \frac{h'}{c}$ so that $h' = c\sin(\alpha')$. Since $\alpha' = 180^\circ - \alpha$, $\sin(\alpha') = \sin(\alpha)$, so in fact, we have $h' = c\sin(\alpha)$. Proceeding to $\triangle BCQ$, we get $\sin(\gamma) = \frac{h'}{a}$ so $h' = a\sin(\gamma)$. Putting this together with the previous equation, we get $\frac{\sin(\gamma)}{c} = \frac{\sin(\alpha)}{a}$, and we are finished with this case.

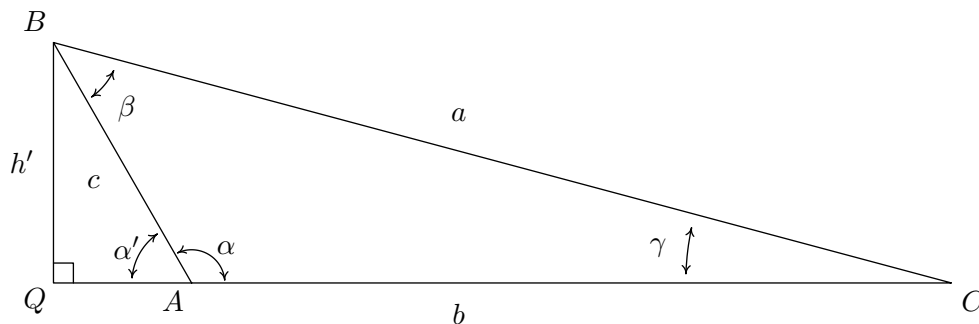

The remaining case is when $\triangle ABC$ is a right triangle. In this case, the Law of Sines reduces to the formulas given in Theorem 8.4 and is left to the reader. In order to use the Law of Sines to solve a triangle, we need at least one angle-side opposite pair. The next example showcases some of the power, and the pitfalls, of the Law of Sines.

Example 9.2.2. Solve the following triangles. Give exact answers and decimal approximations (rounded to hundredths) and sketch the triangle.

- | | |
|---|--|
| 1. $\alpha = 120^\circ$, $a = 7$ units, $\beta = 45^\circ$ | 2. $\alpha = 85^\circ$, $\beta = 30^\circ$, $c = 5.25$ units |
| 3. $\alpha = 30^\circ$, $a = 1$ units, $c = 4$ units | 4. $\alpha = 30^\circ$, $a = 2$ units, $c = 4$ units |
| 5. $\alpha = 30^\circ$, $a = 3$ units, $c = 4$ units | 6. $\alpha = 30^\circ$, $a = 4$ units, $c = 4$ units |

Solution.

- Knowing an angle-side opposite pair, namely α and a , we may proceed in using the Law of Sines. Since $\beta = 45^\circ$, we use $\frac{b}{\sin(45^\circ)} = \frac{7}{\sin(120^\circ)}$ so $b = \frac{7\sin(45^\circ)}{\sin(120^\circ)} = \frac{7\sqrt{6}}{3} \approx 5.72$ units. Now that we have two angle-side pairs, it is time to find the third. To find γ , we use the fact that the sum of the measures of the angles in a triangle is 180° . Hence, $\gamma = 180^\circ - 120^\circ - 45^\circ = 15^\circ$. To find c , we have no choice but to use the derived value $\gamma = 15^\circ$, yet we can minimize the propagation of error here by using the given angle-side opposite pair (α, a) . The Law of Sines gives us $\frac{c}{\sin(15^\circ)} = \frac{7}{\sin(120^\circ)}$ so that $c = \frac{7\sin(15^\circ)}{\sin(120^\circ)} \approx 2.09$ units.⁵
- In this example, we are not immediately given an angle-side opposite pair, but as we have the measures of α and β , we can solve for γ since $\gamma = 180^\circ - 85^\circ - 30^\circ = 65^\circ$. As in the previous example, we are forced to use a derived value in our computations since the only

⁵The exact value of $\sin(15^\circ)$ could be found using the difference identity for sine or a half-angle formula, but that becomes unnecessarily messy for the discussion at hand. Thus “exact” here means $\frac{7\sin(15^\circ)}{\sin(120^\circ)}$.

angle-side pair available is (γ, c) . The Law of Sines gives $\frac{a}{\sin(85^\circ)} = \frac{5.25}{\sin(65^\circ)}$. After the usual rearrangement, we get $a = \frac{5.25 \sin(85^\circ)}{\sin(65^\circ)} \approx 5.77$ units. To find b we use the angle-side pair (γ, c) which yields $\frac{b}{\sin(30^\circ)} = \frac{5.25}{\sin(65^\circ)}$ hence $b = \frac{5.25 \sin(30^\circ)}{\sin(65^\circ)} \approx 2.90$ units.

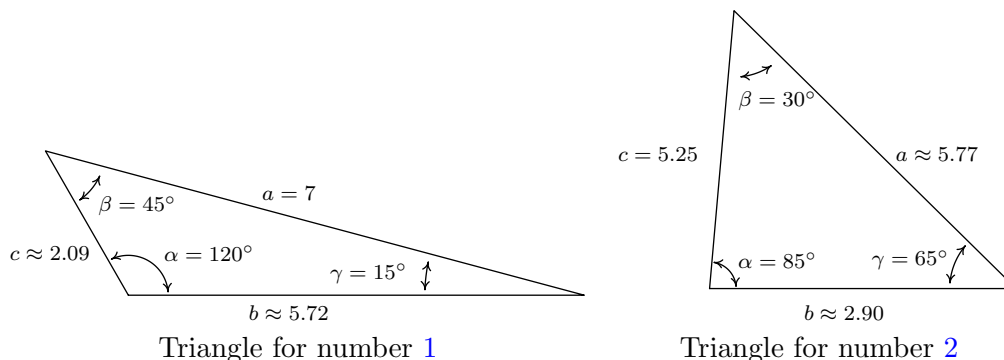

- Since we are given (α, a) and c , we use the Law of Sines to find the measure of γ . We start with $\frac{\sin(\gamma)}{4} = \frac{\sin(30^\circ)}{1}$ and get $\sin(\gamma) = 4 \sin(30^\circ) = 2$. Since the range of the sine function is $[-1, 1]$, there is no real number with $\sin(\gamma) = 2$. Geometrically, we see that side a is just too short to make a triangle. The next three examples keep the same values for the measure of α and the length of c while varying the length of a . We will discuss this case in more detail after we see what happens in those examples.
- In this case, we have the measure of $\alpha = 30^\circ$, $a = 2$ and $c = 4$. Using the Law of Sines, we get $\frac{\sin(\gamma)}{4} = \frac{\sin(30^\circ)}{2}$ so $\sin(\gamma) = 2 \sin(30^\circ) = 1$. Now γ is an angle in a triangle which also contains $\alpha = 30^\circ$. This means that γ must measure between 0° and 150° in order to fit inside the triangle with α . The only angle that satisfies this requirement and has $\sin(\gamma) = 1$ is $\gamma = 90^\circ$. In other words, we have a right triangle. We find the measure of β to be $\beta = 180^\circ - 30^\circ - 90^\circ = 60^\circ$ and then determine b using the Law of Sines. We find $b = \frac{2 \sin(60^\circ)}{\sin(30^\circ)} = 2\sqrt{3} \approx 3.46$ units. In this case, the side a is precisely long enough to form a unique right triangle.

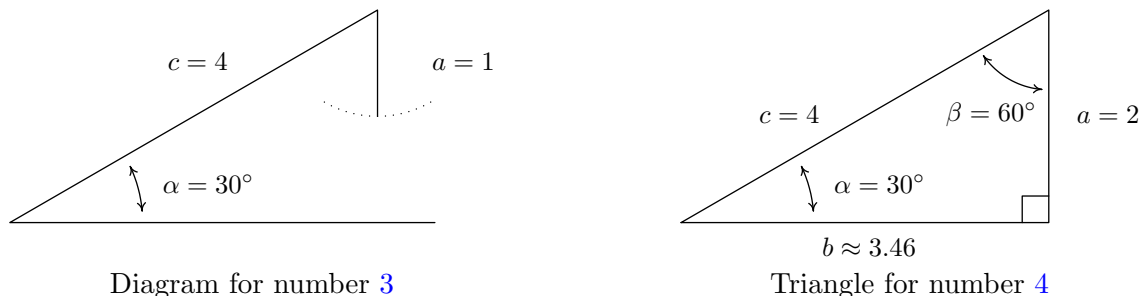

- Proceeding as we have in the previous two examples, we use the Law of Sines to find γ . In this case, we have $\frac{\sin(\gamma)}{4} = \frac{\sin(30^\circ)}{3}$ or $\sin(\gamma) = \frac{4 \sin(30^\circ)}{3} = \frac{2}{3}$. Since γ lies in a triangle with $\alpha = 30^\circ$,

we must have that $0^\circ < \gamma < 150^\circ$. There are two angles γ that fall in this range and have $\sin(\gamma) = \frac{2}{3}$: $\gamma = \arcsin\left(\frac{2}{3}\right)$ radians $\approx 41.81^\circ$ and $\gamma = \pi - \arcsin\left(\frac{2}{3}\right)$ radians $\approx 138.19^\circ$. At this point, we pause to see if it makes sense that we actually have two viable cases to consider. As we have discussed, both candidates for γ are ‘compatible’ with the given angle-side pair $(\alpha, a) = (30^\circ, 3)$ in that both choices for γ can fit in a triangle with α and both have a sine of $\frac{2}{3}$. The only other given piece of information is that $c = 4$ units. Since $c > a$, it must be true that γ , which is opposite c , has greater measure than α which is opposite a . In both cases, $\gamma > \alpha$, so both candidates for γ are compatible with this last piece of given information as well. Thus have two triangles on our hands. In the case $\gamma = \arcsin\left(\frac{2}{3}\right)$ radians $\approx 41.81^\circ$, we find⁶ $\beta \approx 180^\circ - 30^\circ - 41.81^\circ = 108.19^\circ$. Using the Law of Sines with the angle-side opposite pair (α, a) and β , we find $b \approx \frac{3 \sin(108.19^\circ)}{\sin(30^\circ)} \approx 5.70$ units. In the case $\gamma = \pi - \arcsin\left(\frac{2}{3}\right)$ radians $\approx 138.19^\circ$, we repeat the exact same steps and find $\beta \approx 11.81^\circ$ and $b \approx 1.23$ units.⁷ Both triangles are drawn below.

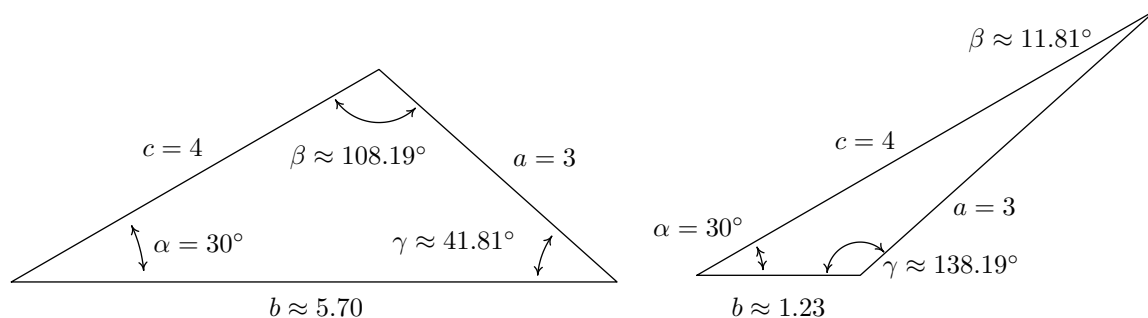

6. For this last problem, we repeat the usual Law of Sines routine to find that $\frac{\sin(\gamma)}{4} = \frac{\sin(30^\circ)}{4}$ so that $\sin(\gamma) = \frac{1}{2}$. Since γ must inhabit a triangle with $\alpha = 30^\circ$, we must have $0^\circ < \gamma < 150^\circ$. Since the measure of γ must be *strictly* less than 150° , there is just one angle which satisfies both required conditions, namely $\gamma = 30^\circ$. So $\beta = 180^\circ - 30^\circ - 30^\circ = 120^\circ$ and, using the Law of Sines one last time, $b = \frac{4 \sin(120^\circ)}{\sin(30^\circ)} = 4\sqrt{3} \approx 6.93$ units.

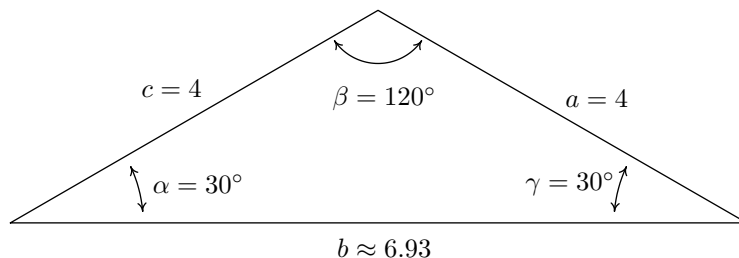

□

Some remarks about Example 9.2.2 are in order. We first note that if we are given the measures of two of the angles in a triangle, say α and β , the measure of the third angle γ is uniquely

⁶To find an exact expression for β , we convert everything back to radians: $\alpha = 30^\circ = \frac{\pi}{6}$ radians, $\gamma = \arcsin\left(\frac{2}{3}\right)$ radians and $180^\circ = \pi$ radians. Hence, $\beta = \pi - \frac{\pi}{6} - \arcsin\left(\frac{2}{3}\right) = \frac{5\pi}{6} - \arcsin\left(\frac{2}{3}\right)$ radians $\approx 108.19^\circ$.

⁷An exact answer for β in this case is $\beta = \arcsin\left(\frac{2}{3}\right) - \frac{\pi}{6}$ radians $\approx 11.81^\circ$.

determined using the equation $\gamma = 180^\circ - \alpha - \beta$. Knowing the measures of all three angles of a triangle completely determines its *shape*. If in addition we are given the length of one of the sides of the triangle, we can then use the Law of Sines to find the lengths of the remaining two sides to determine the *size* of the triangle. Such is the case in numbers 1 and 2 above. In number 1, the given side is adjacent to just one of the angles – this is called the ‘Angle-Angle-Side’ (AAS) case.⁸ In number 2, the given side is adjacent to both angles which means we are in the so-called ‘Angle-Side-Angle’ (ASA) case. If, on the other hand, we are given the measure of just one of the angles in the triangle along with the length of two sides, only one of which is adjacent to the given angle, we are in the ‘Angle-Side-Side’ (ASS) case.⁹ In number 3, the length of the one given side a was too short to even form a triangle; in number 4, the length of a was just long enough to form a right triangle; in 5, a was long enough, but not too long, so that two triangles were possible; and in number 6, side a was long enough to form a triangle but too long to swing back and form two. These four cases exemplify all of the possibilities in the Angle-Side-Side case which are summarized in the following theorem.

Theorem 9.3. Suppose (α, a) and (γ, c) are intended to be angle-side pairs in a triangle where α , a and c are given. Let $h = c \sin(\alpha)$

- If $a < h$, then no triangle exists which satisfies the given criteria.
- If $a = h$, then $\gamma = 90^\circ$ so exactly one (right) triangle exists which satisfies the criteria.
- If $h < a < c$, then two distinct triangles exist which satisfy the given criteria.
- If $a \geq c$, then γ is acute and exactly one triangle exists which satisfies the given criteria

Theorem 9.3 is proved on a case-by-case basis. If $a < h$, then $a < c \sin(\alpha)$. If a triangle were to exist, the Law of Sines would have $\frac{\sin(\gamma)}{c} = \frac{\sin(\alpha)}{a}$ so that $\sin(\gamma) = \frac{c \sin(\alpha)}{a} > \frac{a}{a} = 1$, which is impossible. In the figure below, we see geometrically why this is the case.

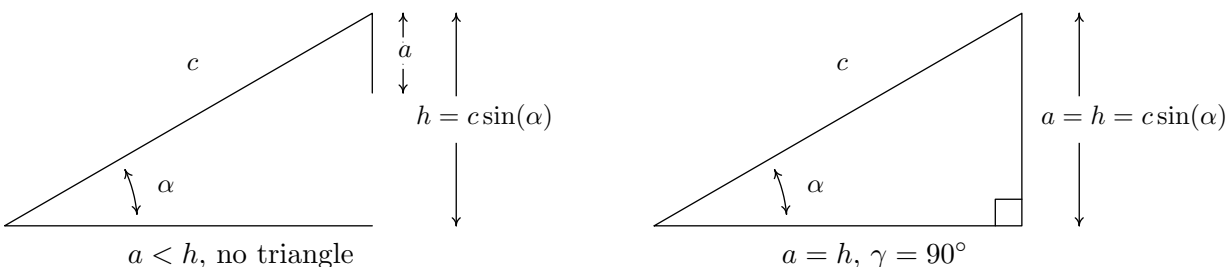

Simply put, if $a < h$ the side a is too short to connect to form a triangle. This means if $a \geq h$, we are always guaranteed to have at least one triangle, and the remaining parts of the theorem

⁸If this sounds familiar, it should. From high school Geometry, we know there are four congruence conditions for triangles: Angle-Angle-Side (AAS), Angle-Side-Angle (ASA), Side-Angle-Side (SAS) and Side-Side-Side (SSS). If we are given information about a triangle that meets one of these four criteria, then we are guaranteed that exactly one triangle exists which satisfies the given criteria.

⁹In more reputable books, this is called the ‘Side-Side-Angle’ or SSA case.

tell us what kind and how many triangles to expect in each case. If $a = h$, then $a = c \sin(\alpha)$ and the Law of Sines gives $\frac{\sin(\alpha)}{a} = \frac{\sin(\gamma)}{c}$ so that $\sin(\gamma) = \frac{c \sin(\alpha)}{a} = \frac{a}{a} = 1$. Here, $\gamma = 90^\circ$ as required. Moving along, now suppose $h < a < c$. As before, the Law of Sines¹⁰ gives $\sin(\gamma) = \frac{c \sin(\alpha)}{a}$. Since $h < a$, $c \sin(\alpha) < a$ or $\frac{c \sin(\alpha)}{a} < 1$ which means there are two solutions to $\sin(\gamma) = \frac{c \sin(\alpha)}{a}$: an acute angle which we'll call γ_0 , and its supplement, $180^\circ - \gamma_0$. We need to argue that each of these angles 'fit' into a triangle with α . Since (α, a) and (γ_0, c) are angle-side opposite pairs, the assumption $c > a$ in this case gives us $\gamma_0 > \alpha$. Since γ_0 is acute, we must have that α is acute as well. This means one triangle can contain both α and γ_0 , giving us one of the triangles promised in the theorem. If we manipulate the inequality $\gamma_0 > \alpha$ a bit, we have $180^\circ - \gamma_0 < 180^\circ - \alpha$ which gives $(180^\circ - \gamma_0) + \alpha < 180^\circ$. This proves a triangle can contain both of the angles α and $(180^\circ - \gamma_0)$, giving us the second triangle predicted in the theorem. To prove the last case in the theorem, we assume $a \geq c$. Then $\alpha \geq \gamma$, which forces γ to be an acute angle. Hence, we get only one triangle in this case, completing the proof.

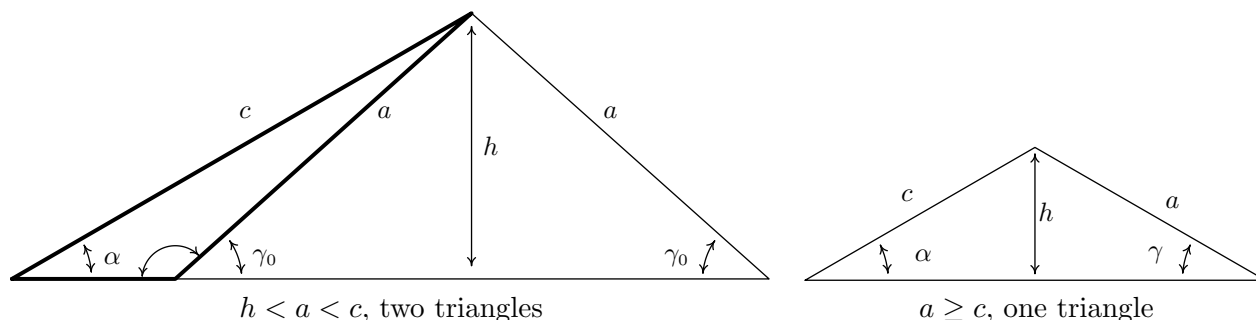

One last comment before we use the Law of Sines to solve an application problem. In the Angle-Side-Side case, if you are given an obtuse angle to begin with then it is impossible to have the two triangle case. Think about this before reading further.

Example 9.2.3. Sasquatch Island lies off the coast of Ippizuti Lake. Two sightings, taken 5 miles apart, are made to the island. The angle between the shore and the island at the first observation point is 30° and at the second point the angle is 45° . Assuming a straight coastline, find the distance from the second observation point to the island. What point on the shore is closest to the island? How far is the island from this point?

Solution. We sketch the problem below with the first observation point labeled as P and the second as Q . In order to use the Law of Sines to find the distance d from Q to the island, we first need to find the measure of β which is the angle opposite the side of length 5 miles. To that end, we note that the angles γ and 45° are supplemental, so that $\gamma = 180^\circ - 45^\circ = 135^\circ$. We can now find $\beta = 180^\circ - 30^\circ - \gamma = 180^\circ - 30^\circ - 135^\circ = 15^\circ$. By the Law of Sines, we have $\frac{d}{\sin(30^\circ)} = \frac{5}{\sin(15^\circ)}$ which gives $d = \frac{5 \sin(30^\circ)}{\sin(15^\circ)} \approx 9.66$ miles. Next, to find the point on the coast closest to the island, which we've labeled as C , we need to find the perpendicular distance from the island to the coast.¹¹

¹⁰Remember, we have already argued that a triangle exists in this case!

¹¹Do you see why C must lie to the right of Q ?

Let x denote the distance from the second observation point Q to the point C and let y denote the distance from C to the island. Using Theorem 8.4, we get $\sin(45^\circ) = \frac{y}{d}$. After some rearranging, we find $y = d \sin(45^\circ) \approx 9.66 \left(\frac{\sqrt{2}}{2}\right) \approx 6.83$ miles. Hence, the island is approximately 6.83 miles from the coast. To find the distance from Q to C , we note that $\beta = 180^\circ - 90^\circ - 45^\circ = 45^\circ$ so by symmetry,¹² we get $x = y \approx 6.83$ miles. Hence, the point on the shore closest to the island is approximately 6.83 miles down the coast from the second observation point.

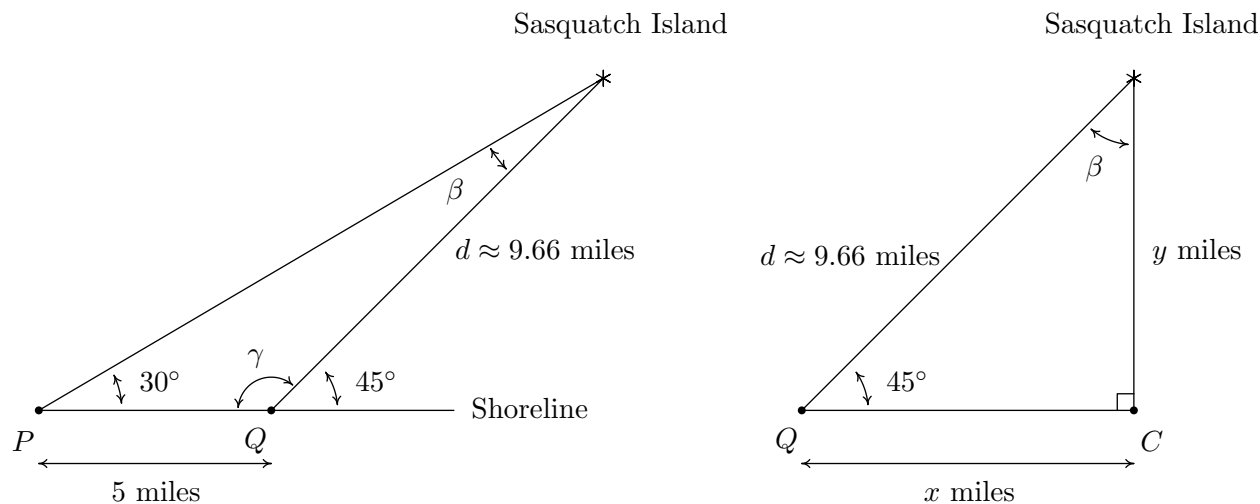

□

We close this section with a new formula to compute the area enclosed by a triangle. Its proof uses the same cases and diagrams as the proof of the Law of Sines and is left as an exercise.

Theorem 9.4. Suppose (α, a) , (β, b) and (γ, c) are the angle-side opposite pairs of a triangle. Then the area A enclosed by the triangle is given by

$$A = \frac{1}{2}bc \sin(\alpha) = \frac{1}{2}ac \sin(\beta) = \frac{1}{2}ab \sin(\gamma)$$

Example 9.2.4. Find the area of the triangle in Example 9.2.2 number 1.

Solution. From our work in Example 9.2.2 number 1, we have all three angles and all three sides to work with. However, to minimize propagated error, we choose $A = \frac{1}{2}ac \sin(\beta)$ from Theorem 9.4 because it uses the most pieces of given information. We are given $a = 7$ and $\beta = 45^\circ$, and we calculated $c = \frac{7 \sin(15^\circ)}{\sin(120^\circ)}$. Using these values, we find $A = \frac{1}{2}(7) \left(\frac{7 \sin(15^\circ)}{\sin(120^\circ)}\right) \sin(45^\circ) \approx 5.18$ square units. The reader is encouraged to check this answer against the results obtained using the other formulas in Theorem 9.4. □

¹²Or by Theorem 8.4 again ...

9.2.1 EXERCISES

In Exercises 1 - 20, solve for the remaining side(s) and angle(s) if possible. As in the text, (α, a) , (β, b) and (γ, c) are angle-side opposite pairs.

- | | |
|---|---|
| 1. $\alpha = 13^\circ$, $\beta = 17^\circ$, $a = 5$ | 2. $\alpha = 73.2^\circ$, $\beta = 54.1^\circ$, $a = 117$ |
| 3. $\alpha = 95^\circ$, $\beta = 85^\circ$, $a = 33.33$ | 4. $\alpha = 95^\circ$, $\beta = 62^\circ$, $a = 33.33$ |
| 5. $\alpha = 117^\circ$, $a = 35$, $b = 42$ | 6. $\alpha = 117^\circ$, $a = 45$, $b = 42$ |
| 7. $\alpha = 68.7^\circ$, $a = 88$, $b = 92$ | 8. $\alpha = 42^\circ$, $a = 17$, $b = 23.5$ |
| 9. $\alpha = 68.7^\circ$, $a = 70$, $b = 90$ | 10. $\alpha = 30^\circ$, $a = 7$, $b = 14$ |
| 11. $\alpha = 42^\circ$, $a = 39$, $b = 23.5$ | 12. $\gamma = 53^\circ$, $\alpha = 53^\circ$, $c = 28.01$ |
| 13. $\alpha = 6^\circ$, $a = 57$, $b = 100$ | 14. $\gamma = 74.6^\circ$, $c = 3$, $a = 3.05$ |
| 15. $\beta = 102^\circ$, $b = 16.75$, $c = 13$ | 16. $\beta = 102^\circ$, $b = 16.75$, $c = 18$ |
| 17. $\beta = 102^\circ$, $\gamma = 35^\circ$, $b = 16.75$ | 18. $\beta = 29.13^\circ$, $\gamma = 83.95^\circ$, $b = 314.15$ |
| 19. $\gamma = 120^\circ$, $\beta = 61^\circ$, $c = 4$ | 20. $\alpha = 50^\circ$, $a = 25$, $b = 12.5$ |

21. Find the area of the triangles given in Exercises 1, 12 and 20 above.

(Another Classic Application: Grade of a Road) The grade of a road is much like the pitch of a roof (See Example 8.6.6) in that it expresses the ratio of rise/run. In the case of a road, this ratio is always positive because it is measured going uphill and it is usually given as a percentage. For example, a road which rises 7 feet for every 100 feet of (horizontal) forward progress is said to have a 7% grade. However, if we want to apply any Trigonometry to a story problem involving roads going uphill or downhill, we need to view the grade as an angle with respect to the horizontal. In Exercises 22 - 24, we first have you change road grades into angles and then use the Law of Sines in an application.

22. Using a right triangle with a horizontal leg of length 100 and vertical leg with length 7, show that a 7% grade means that the road (hypotenuse) makes about a 4° angle with the horizontal. (It will not be exactly 4° , but it's pretty close.)
23. What grade is given by a 9.65° angle made by the road and the horizontal?¹³

¹³I have friends who live in Pacifica, CA and their road is actually this steep. It's not a nice road to drive.

24. Along a long, straight stretch of mountain road with a 7% grade, you see a tall tree standing perfectly plumb alongside the road.¹⁴ From a point 500 feet downhill from the tree, the angle of inclination from the road to the top of the tree is 6° . Use the Law of Sines to find the height of the tree. (Hint: First show that the tree makes a 94° angle with the road.)

(Another Classic Application: Bearings) In the next several exercises we introduce and work with the navigation tool known as bearings. Simply put, a bearing is the direction you are heading according to a compass. The classic nomenclature for bearings, however, is not given as an angle in standard position, so we must first understand the notation. A bearing is given as an acute angle of rotation (to the east or to the west) away from the north-south (up and down) line of a compass rose. For example, $N40^\circ E$ (read “40° east of north”) is a bearing which is rotated clockwise 40° from due north. If we imagine standing at the origin in the Cartesian Plane, this bearing would have us heading into Quadrant I along the terminal side of $\theta = 50^\circ$. Similarly, $S50^\circ W$ would point into Quadrant III along the terminal side of $\theta = 220^\circ$ because we started out pointing due south (along $\theta = 270^\circ$) and rotated clockwise 50° back to 220° . Counter-clockwise rotations would be found in the bearings $N60^\circ W$ (which is on the terminal side of $\theta = 150^\circ$) and $S27^\circ E$ (which lies along the terminal side of $\theta = 297^\circ$). These four bearings are drawn in the plane below.

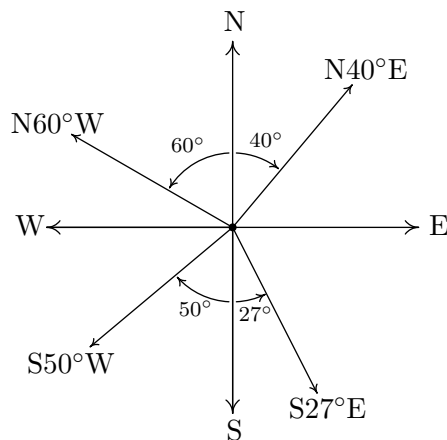

The cardinal directions north, south, east and west are usually not given as bearings in the fashion described above, but rather, one just refers to them as ‘due north’, ‘due south’, ‘due east’ and ‘due west’, respectively, and it is assumed that you know which quadrantal angle goes with each cardinal direction. (Hint: Look at the diagram above.)

25. Find the angle θ in standard position with $0^\circ \leq \theta < 360^\circ$ which corresponds to each of the bearings given below.
- (a) due west (b) $S83^\circ E$ (c) $N5.5^\circ E$ (d) due south

¹⁴The word ‘plumb’ here means that the tree is perpendicular to the horizontal.

(e) $N31.25^\circ W$ (f) $S72^\circ 41' 12'' W$ ¹⁵ (g) $N45^\circ E$ (h) $S45^\circ W$

26. The Colonel spots a campfire at a bearing of $N42^\circ E$ from his current position. Sarge, who is positioned 3000 feet due east of the Colonel, reckons the bearing to the fire to be $N20^\circ W$ from his current position. Determine the distance from the campfire to each man, rounded to the nearest foot.
27. A hiker starts walking due west from Sasquatch Point and gets to the Chupacabra Trailhead before she realizes that she hasn't reset her pedometer. From the Chupacabra Trailhead she hikes for 5 miles along a bearing of $N53^\circ W$ which brings her to the Muffin Ridge Observatory. From there, she knows a bearing of $S65^\circ E$ will take her straight back to Sasquatch Point. How far will she have to walk to get from the Muffin Ridge Observatory to Sasquatch Point? What is the distance between Sasquatch Point and the Chupacabra Trailhead?
28. The captain of the SS Bigfoot sees a signal flare at a bearing of $N15^\circ E$ from her current location. From his position, the captain of the HMS Sasquatch finds the signal flare to be at a bearing of $N75^\circ W$. If the SS Bigfoot is 5 miles from the HMS Sasquatch and the bearing from the SS Bigfoot to the HMS Sasquatch is $N50^\circ E$, find the distances from the flare to each vessel, rounded to the nearest tenth of a mile.
29. Carl spies a potential Sasquatch nest at a bearing of $N10^\circ E$ and radios Jeff, who is at a bearing of $N50^\circ E$ from Carl's position. From Jeff's position, the nest is at a bearing of $S70^\circ W$. If Jeff and Carl are 500 feet apart, how far is Jeff from the Sasquatch nest? Round your answer to the nearest foot.
30. A hiker determines the bearing to a lodge from her current position is $S40^\circ W$. She proceeds to hike 2 miles at a bearing of $S20^\circ E$ at which point she determines the bearing to the lodge is $S75^\circ W$. How far is she from the lodge at this point? Round your answer to the nearest hundredth of a mile.
31. A watchtower spots a ship off shore at a bearing of $N70^\circ E$. A second tower, which is 50 miles from the first at a bearing of $S80^\circ E$ from the first tower, determines the bearing to the ship to be $N25^\circ W$. How far is the boat from the second tower? Round your answer to the nearest tenth of a mile.
32. Skippy and Sally decide to hunt UFOs. One night, they position themselves 2 miles apart on an abandoned stretch of desert runway. An hour into their investigation, Skippy spies a UFO hovering over a spot on the runway directly between him and Sally. He records the angle of inclination from the ground to the craft to be 75° and radios Sally immediately to find the angle of inclination from her position to the craft is 50° . How high off the ground is the UFO at this point? Round your answer to the nearest foot. (Recall: 1 mile is 5280 feet.)

¹⁵See Example 8.1.1 in Section 8.1 for a review of the DMS system.

33. The angle of depression from an observer in an apartment complex to a gargoyle on the building next door is 55° . From a point five stories below the original observer, the angle of inclination to the gargoyle is 20° . Find the distance from each observer to the gargoyle and the distance from the gargoyle to the apartment complex. Round your answers to the nearest foot. (Use the rule of thumb that one story of a building is 9 feet.)
34. Prove that the Law of Sines holds when $\triangle ABC$ is a right triangle.
35. Discuss with your classmates why knowing only the three angles of a triangle is not enough to determine any of the sides.
36. Discuss with your classmates why the Law of Sines cannot be used to find the angles in the triangle when only the three sides are given. Also discuss what happens if only two sides and the angle between them are given. (Said another way, explain why the Law of Sines cannot be used in the SSS and SAS cases.)
37. Given $\alpha = 30^\circ$ and $b = 10$, choose four different values for a so that
- (a) the information yields no triangle
 - (b) the information yields exactly one right triangle
 - (c) the information yields two distinct triangles
 - (d) the information yields exactly one obtuse triangle

Explain why you cannot choose a in such a way as to have $\alpha = 30^\circ$, $b = 10$ and your choice of a yield only one triangle where that unique triangle has three acute angles.

38. Use the cases and diagrams in the proof of the Law of Sines (Theorem 9.2) to prove the area formulas given in Theorem 9.4. Why do those formulas yield square units when four quantities are being multiplied together?

9.2.2 ANSWERS

1. $\alpha = 13^\circ$ $\beta = 17^\circ$ $\gamma = 150^\circ$
 $a = 5$ $b \approx 6.50$ $c \approx 11.11$
2. $\alpha = 73.2^\circ$ $\beta = 54.1^\circ$ $\gamma = 52.7^\circ$
 $a = 117$ $b \approx 99.00$ $c \approx 97.22$
3. Information does not produce a triangle
4. $\alpha = 95^\circ$ $\beta = 62^\circ$ $\gamma = 23^\circ$
 $a = 33.33$ $b \approx 29.54$ $c \approx 13.07$
5. Information does not produce a triangle
6. $\alpha = 117^\circ$ $\beta \approx 56.3^\circ$ $\gamma \approx 6.7^\circ$
 $a = 45$ $b = 42$ $c \approx 5.89$
7. $\alpha = 68.7^\circ$ $\beta \approx 76.9^\circ$ $\gamma \approx 34.4^\circ$
 $a = 88$ $b = 92$ $c \approx 53.36$
 $\alpha = 68.7^\circ$ $\beta \approx 103.1^\circ$ $\gamma \approx 8.2^\circ$
 $a = 88$ $b = 92$ $c \approx 13.47$
8. $\alpha = 42^\circ$ $\beta \approx 67.66^\circ$ $\gamma \approx 70.34^\circ$
 $a = 17$ $b = 23.5$ $c \approx 23.93$
 $\alpha = 42^\circ$ $\beta \approx 112.34^\circ$ $\gamma \approx 25.66^\circ$
 $a = 17$ $b = 23.5$ $c \approx 11.00$
9. Information does not produce a triangle
10. $\alpha = 30^\circ$ $\beta = 90^\circ$ $\gamma = 60^\circ$
 $a = 7$ $b = 14$ $c = 7\sqrt{3}$
11. $\alpha = 42^\circ$ $\beta \approx 23.78^\circ$ $\gamma \approx 114.22^\circ$
 $a = 39$ $b = 23.5$ $c \approx 53.15$
12. $\alpha = 53^\circ$ $\beta = 74^\circ$ $\gamma = 53^\circ$
 $a = 28.01$ $b \approx 33.71$ $c = 28.01$
13. $\alpha = 6^\circ$ $\beta \approx 169.43^\circ$ $\gamma \approx 4.57^\circ$
 $a = 57$ $b = 100$ $c \approx 43.45$
 $\alpha = 6^\circ$ $\beta \approx 10.57^\circ$ $\gamma \approx 163.43^\circ$
 $a = 57$ $b = 100$ $c \approx 155.51$
14. $\alpha \approx 78.59^\circ$ $\beta \approx 26.81^\circ$ $\gamma = 74.6^\circ$
 $a = 3.05$ $b \approx 1.40$ $c = 3$
 $\alpha \approx 101.41^\circ$ $\beta \approx 3.99^\circ$ $\gamma = 74.6^\circ$
 $a = 3.05$ $b \approx 0.217$ $c = 3$
15. $\alpha \approx 28.61^\circ$ $\beta = 102^\circ$ $\gamma \approx 49.39^\circ$
 $a \approx 8.20$ $b = 16.75$ $c = 13$
16. Information does not produce a triangle
17. $\alpha = 43^\circ$ $\beta = 102^\circ$ $\gamma = 35^\circ$
 $a \approx 11.68$ $b = 16.75$ $c \approx 9.82$
18. $\alpha = 66.92^\circ$ $\beta = 29.13^\circ$ $\gamma = 83.95^\circ$
 $a \approx 593.69$ $b = 314.15$ $c \approx 641.75$
19. Information does not produce a triangle
20. $\alpha = 50^\circ$ $\beta \approx 22.52^\circ$ $\gamma \approx 107.48^\circ$
 $a = 25$ $b = 12.5$ $c \approx 31.13$
21. The area of the triangle from Exercise 1 is about 8.1 square units.
The area of the triangle from Exercise 12 is about 377.1 square units.
The area of the triangle from Exercise 20 is about 149 square units.
22. $\arctan\left(\frac{7}{100}\right) \approx 0.699$ radians, which is equivalent to 4.004°
23. About 17%
24. About 53 feet

25. (a) $\theta = 180^\circ$ (b) $\theta = 353^\circ$ (c) $\theta = 84.5^\circ$ (d) $\theta = 270^\circ$
(e) $\theta = 121.25^\circ$ (f) $\theta = 197^\circ 18' 48''$ (g) $\theta = 45^\circ$ (h) $\theta = 225^\circ$
26. The Colonel is about 3193 feet from the campfire.
Sarge is about 2525 feet to the campfire.
27. The distance from the Muffin Ridge Observatory to Sasquach Point is about 7.12 miles.
The distance from Sasquatch Point to the Chupacabra Trailhead is about 2.46 miles.
28. The SS Bigfoot is about 4.1 miles from the flare.
The HMS Sasquatch is about 2.9 miles from the flare.
29. Jeff is about 371 feet from the nest.
30. She is about 3.02 miles from the lodge
31. The boat is about 25.1 miles from the second tower.
32. The UFO is hovering about 9539 feet above the ground.
33. The gargoyle is about 44 feet from the observer on the upper floor.
The gargoyle is about 27 feet from the observer on the lower floor.
The gargoyle is about 25 feet from the other building.

9.3 POLAR COORDINATES

In Section 1.1, we introduced the Cartesian coordinates of a point in the plane as a means of assigning ordered pairs of numbers to points in the plane. We defined the Cartesian coordinate plane using two number lines – one horizontal and one vertical – which intersect at right angles at a point we called the ‘origin’. To plot a point, say $P(-3, 4)$, we start at the origin, travel horizontally to the left 3 units, then up 4 units. Alternatively, we could start at the origin, travel up 4 units, then to the left 3 units and arrive at the same location. For the most part, the ‘motions’ of the Cartesian system (over and up) describe a rectangle, and most points can be thought of as the corner diagonally across the rectangle from the origin.¹ For this reason, the Cartesian coordinates of a point are often called ‘rectangular’ coordinates. In this section, we introduce a new system for assigning coordinates to points in the plane – **polar coordinates**. We start with an origin point, called the **pole**, and a ray called the **polar axis**. We then locate a point P using two coordinates, (r, θ) , where r represents a *directed* distance from the pole² and θ is a measure of rotation from the polar axis. Roughly speaking, the polar coordinates (r, θ) of a point measure ‘how far out’ the point is from the pole (that’s r), and ‘how far to rotate’ from the polar axis, (that’s θ).

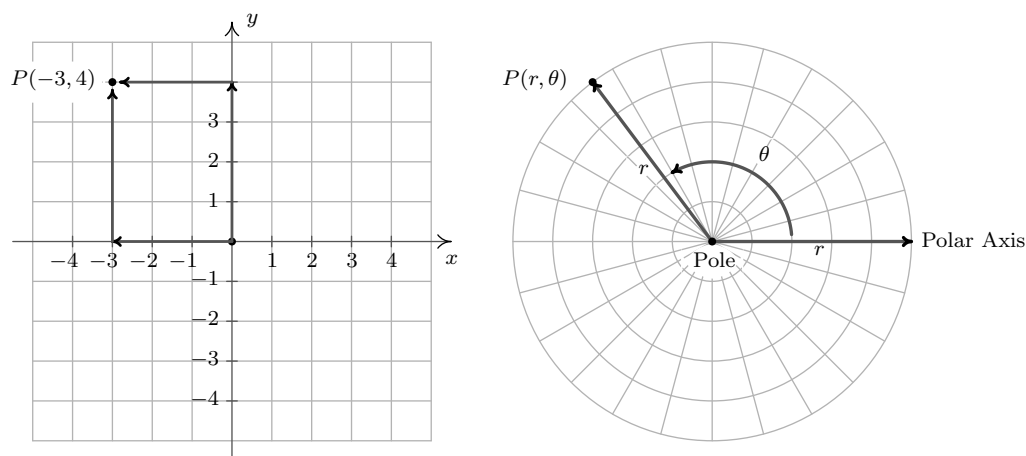

For example, if we wished to plot the point P with polar coordinates $(4, \frac{5\pi}{6})$, we’d start at the pole, move out along the polar axis 4 units, then rotate $\frac{5\pi}{6}$ radians counter-clockwise.

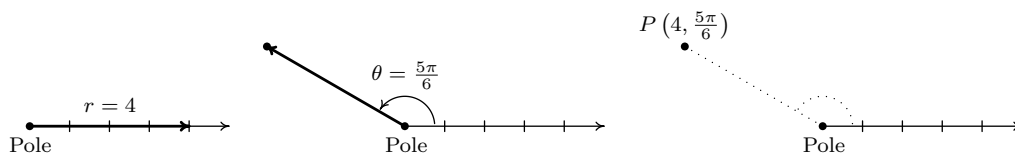

We may also visualize this process by thinking of the rotation first.³ To plot $P(4, \frac{5\pi}{6})$ this way, we rotate $\frac{5\pi}{6}$ counter-clockwise from the polar axis, then move outwards from the pole 4 units.

¹Excluding, of course, the points in which one or both coordinates are 0.

²We will explain more about this momentarily.

³As with anything in Mathematics, the more ways you have to look at something, the better. The authors encourage the reader to take time to think about both approaches to plotting points given in polar coordinates.

Essentially we are locating a point on the terminal side of $\frac{5\pi}{6}$ which is 4 units away from the pole.

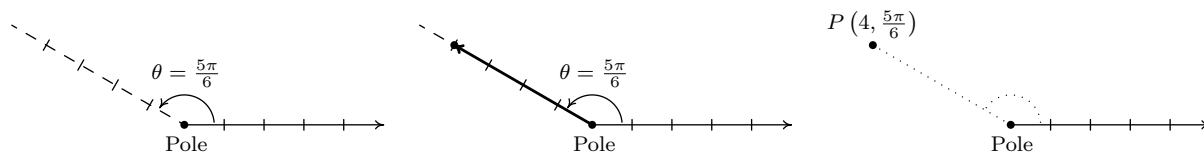

If $r < 0$, we begin by moving in the opposite direction on the polar axis from the pole. For example, to plot $Q(-3.5, \frac{\pi}{4})$ we have

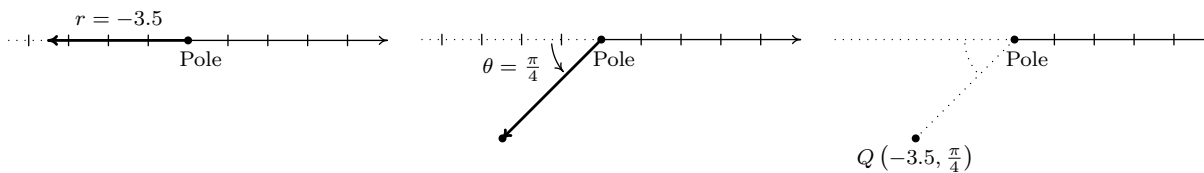

If we interpret the angle first, we rotate $\frac{\pi}{4}$ radians, then move back through the pole 3.5 units. Here we are locating a point 3.5 units away from the pole on the terminal side of $\frac{5\pi}{4}$, not $\frac{\pi}{4}$.

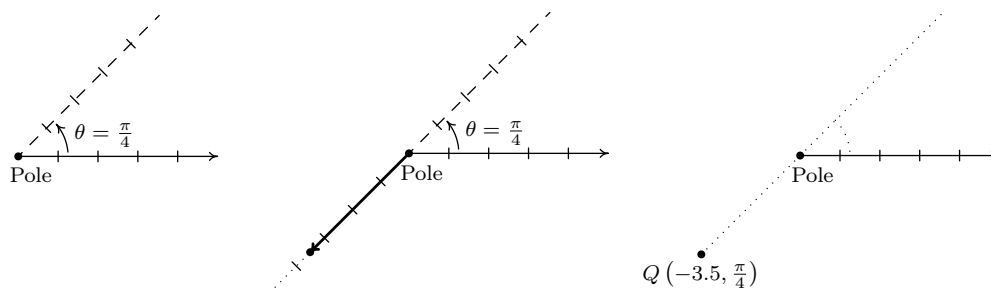

As you may have guessed, $\theta < 0$ means the rotation away from the polar axis is clockwise instead of counter-clockwise. Hence, to plot $R(3.5, -\frac{3\pi}{4})$ we have the following.

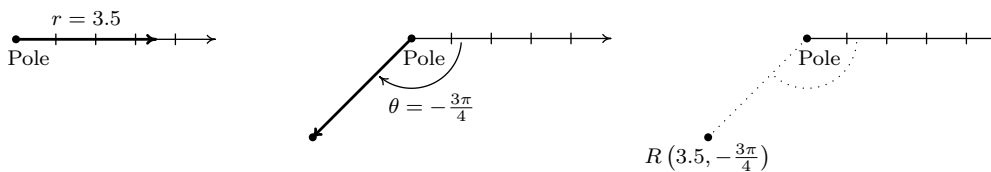

From an 'angles first' approach, we rotate $-\frac{3\pi}{4}$ then move out 3.5 units from the pole. We see that R is the point on the terminal side of $\theta = -\frac{3\pi}{4}$ which is 3.5 units from the pole.

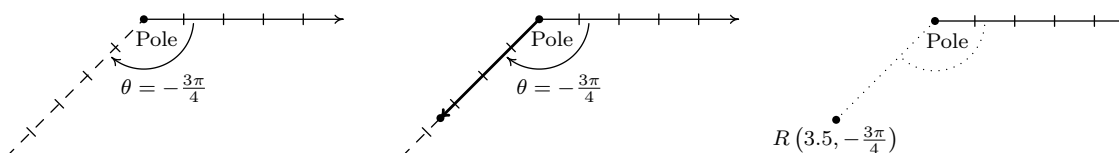

The points Q and R above are, in fact, the same point despite the fact that their polar coordinate representations are different. Unlike Cartesian coordinates where (a, b) and (c, d) represent the same point if and only if $a = c$ and $b = d$, a point can be represented by infinitely many polar coordinate pairs. We explore this notion more in the following example.

Example 9.3.1. For each point in polar coordinates given below plot the point and then give two additional expressions for the point, one of which has $r > 0$ and the other with $r < 0$.

1. $P(2, 240^\circ)$ 2. $P(-4, \frac{7\pi}{6})$ 3. $P(117, -\frac{5\pi}{2})$ 4. $P(-3, -\frac{\pi}{4})$

Solution.

1. Whether we move 2 units along the polar axis and then rotate 240° or rotate 240° then move out 2 units from the pole, we plot $P(2, 240^\circ)$ below.



We now set about finding alternate descriptions (r, θ) for the point P . Since P is 2 units from the pole, $r = \pm 2$. Next, we choose angles θ for each of the r values. The given representation for P is $(2, 240^\circ)$ so the angle θ we choose for the $r = 2$ case must be coterminal with 240° . (Can you see why?) One such angle is $\theta = -120^\circ$ so one answer for this case is $(2, -120^\circ)$. For the case $r = -2$, we visualize our rotation starting 2 units to the left of the pole. From this position, we need only to rotate $\theta = 60^\circ$ to arrive at location coterminal with 240° . Hence, our answer here is $(-2, 60^\circ)$. We check our answers by plotting them.



2. We plot $(-4, \frac{7\pi}{6})$ by first moving 4 units to the left of the pole and then rotating $\frac{7\pi}{6}$ radians. Since $r = -4 < 0$, we find our point lies 4 units from the pole on the terminal side of $\frac{\pi}{6}$.

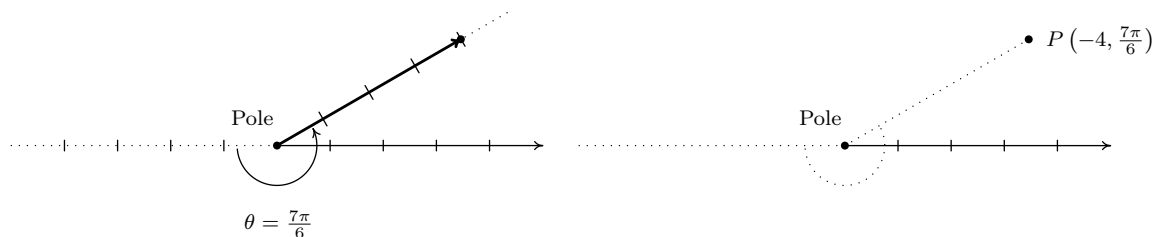

To find alternate descriptions for P , we note that the distance from P to the pole is 4 units, so any representation (r, θ) for P must have $r = \pm 4$. As we noted above, P lies on the terminal side of $\frac{\pi}{6}$, so this, coupled with $r = 4$, gives us $(4, \frac{\pi}{6})$ as one of our answers. To find a different representation for P with $r = -4$, we may choose any angle coterminal with the angle in the original representation of P $(-4, \frac{7\pi}{6})$. We pick $-\frac{5\pi}{6}$ and get $(-4, -\frac{5\pi}{6})$ as our second answer.

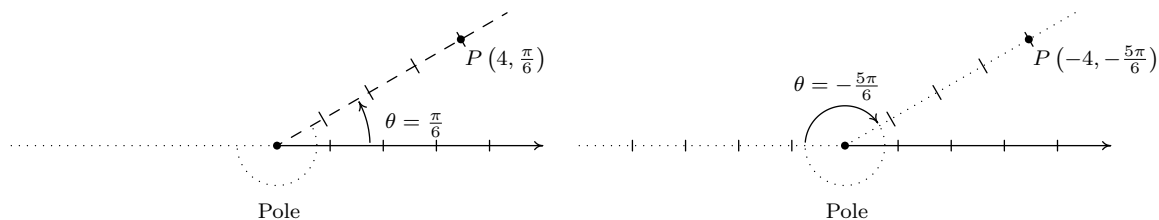

3. To plot $P(117, -\frac{5\pi}{2})$, we move along the polar axis 117 units from the pole and rotate *clockwise* $\frac{5\pi}{2}$ radians as illustrated below.



Since P is 117 units from the pole, any representation (r, θ) for P satisfies $r = \pm 117$. For the $r = 117$ case, we can take θ to be any angle coterminal with $-\frac{5\pi}{2}$. In this case, we choose $\theta = \frac{3\pi}{2}$, and get $(117, \frac{3\pi}{2})$ as one answer. For the $r = -117$ case, we visualize moving left 117 units from the pole and then rotating through an angle θ to reach P . We find that $\theta = \frac{\pi}{2}$ satisfies this requirement, so our second answer is $(-117, \frac{\pi}{2})$.

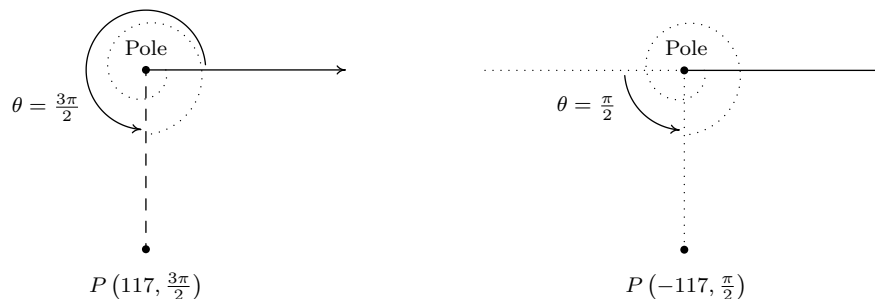

4. We move three units to the left of the pole and follow up with a clockwise rotation of $\frac{\pi}{4}$ radians to plot $P(-3, -\frac{\pi}{4})$. We see that P lies on the terminal side of $\frac{3\pi}{4}$.

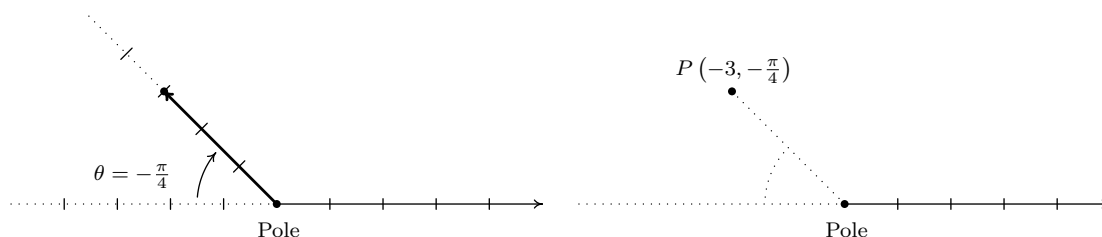

Since P lies on the terminal side of $\frac{3\pi}{4}$, one alternative representation for P is $(3, \frac{3\pi}{4})$. To find a different representation for P with $r = -3$, we may choose any angle coterminal with $-\frac{\pi}{4}$. We choose $\theta = \frac{7\pi}{4}$ for our final answer $(-3, \frac{7\pi}{4})$.

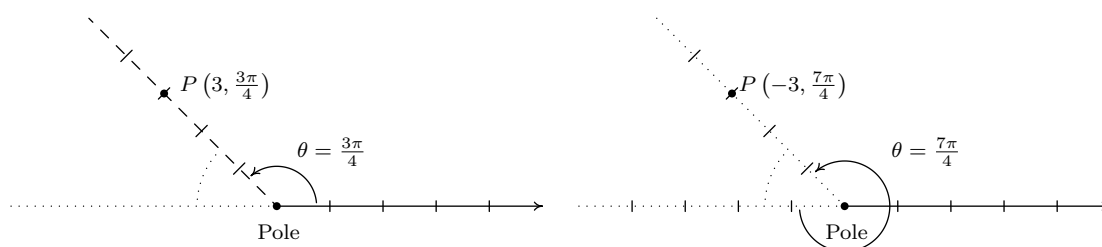

□

Now that we have had some practice with plotting points in polar coordinates, it should come as no surprise that any given point expressed in polar coordinates has infinitely many other representations in polar coordinates. The following result characterizes when two sets of polar coordinates determine the same point in the plane. It could be considered as a definition or a theorem, depending on your point of view. We state it as a property of the polar coordinate system.

Equivalent Representations of Points in Polar Coordinates

Suppose (r, θ) and (r', θ') are polar coordinates where $r \neq 0$, $r' \neq 0$ and the angles are measured in radians. Then (r, θ) and (r', θ') determine the same point P if and only if one of the following is true:

- $r' = r$ and $\theta' = \theta + 2\pi k$ for some integer k
- $r' = -r$ and $\theta' = \theta + (2k + 1)\pi$ for some integer k

All polar coordinates of the form $(0, \theta)$ represent the pole regardless of the value of θ .

The key to understanding this result, and indeed the whole polar coordinate system, is to keep in mind that (r, θ) means (directed distance from pole, angle of rotation). If $r = 0$, then no matter how much rotation is performed, the point never leaves the pole. Thus $(0, \theta)$ is the pole for all

values of θ . Now let's assume that neither r nor r' is zero. If (r, θ) and (r', θ') determine the same point P then the (non-zero) distance from P to the pole in each case must be the same. Since this distance is controlled by the first coordinate, we have that either $r' = r$ or $r' = -r$. If $r' = r$, then when plotting (r, θ) and (r', θ') , the angles θ and θ' have the same initial side. Hence, if (r, θ) and (r', θ') determine the same point, we must have that θ' is coterminal with θ . We know that this means $\theta' = \theta + 2\pi k$ for some integer k , as required. If, on the other hand, $r' = -r$, then when plotting (r, θ) and (r', θ') , the initial side of θ' is rotated π radians away from the initial side of θ . In this case, θ' must be coterminal with $\pi + \theta$. Hence, $\theta' = \pi + \theta + 2\pi k$ which we rewrite as $\theta' = \theta + (2k + 1)\pi$ for some integer k . Conversely, if $r' = r$ and $\theta' = \theta + 2\pi k$ for some integer k , then the points $P(r, \theta)$ and $P'(r', \theta')$ lie the same (directed) distance from the pole on the terminal sides of coterminal angles, and hence are the same point. Now suppose $r' = -r$ and $\theta' = \theta + (2k + 1)\pi$ for some integer k . To plot P , we first move a directed distance r from the pole; to plot P' , our first step is to move the same distance from the pole as P , but in the opposite direction. At this intermediate stage, we have two points equidistant from the pole rotated exactly π radians apart. Since $\theta' = \theta + (2k + 1)\pi = (\theta + \pi) + 2\pi k$ for some integer k , we see that θ' is coterminal to $(\theta + \pi)$ and it is this extra π radians of rotation which aligns the points P and P' .

Next, we marry the polar coordinate system with the Cartesian (rectangular) coordinate system. To do so, we identify the pole and polar axis in the polar system to the origin and positive x -axis, respectively, in the rectangular system. We get the following result.

Theorem 9.5. Conversion Between Rectangular and Polar Coordinates: Suppose P is represented in rectangular coordinates as (x, y) and in polar coordinates as (r, θ) . Then

- $x = r \cos(\theta)$ and $y = r \sin(\theta)$
- $x^2 + y^2 = r^2$ and $\tan(\theta) = \frac{y}{x}$ (provided $x \neq 0$)

In the case $r > 0$, Theorem 9.5 is an immediate consequence of Theorem 8.3 along with the quotient identity $\tan(\theta) = \frac{\sin(\theta)}{\cos(\theta)}$. If $r < 0$, then we know an alternate representation for (r, θ) is $(-r, \theta + \pi)$. Since $\cos(\theta + \pi) = -\cos(\theta)$ and $\sin(\theta + \pi) = -\sin(\theta)$, applying the theorem to $(-r, \theta + \pi)$ gives $x = (-r) \cos(\theta + \pi) = (-r)(-\cos(\theta)) = r \cos(\theta)$ and $y = (-r) \sin(\theta + \pi) = (-r)(-\sin(\theta)) = r \sin(\theta)$. Moreover, $x^2 + y^2 = (-r)^2 = r^2$, and $\frac{y}{x} = \tan(\theta + \pi) = \tan(\theta)$, so the theorem is true in this case, too. The remaining case is $r = 0$, in which case $(r, \theta) = (0, \theta)$ is the pole. Since the pole is identified with the origin $(0, 0)$ in rectangular coordinates, the theorem in this case amounts to checking '0 = 0.' The following example puts Theorem 9.5 to good use.

Example 9.3.2. Convert each point in rectangular coordinates given below into polar coordinates with $r \geq 0$ and $0 \leq \theta < 2\pi$. Use exact values if possible and round any approximate values to two decimal places. Check your answer by converting them back to rectangular coordinates.

1. $P(2, -2\sqrt{3})$
2. $Q(-3, -3)$
3. $R(0, -3)$
4. $S(-3, 4)$

Solution.

1. Even though we are not explicitly told to do so, we can avoid many common mistakes by taking the time to plot the points before we do any calculations. Plotting $P(2, -2\sqrt{3})$ shows that it lies in Quadrant IV. With $x = 2$ and $y = -2\sqrt{3}$, we get $r^2 = x^2 + y^2 = (2)^2 + (-2\sqrt{3})^2 = 4 + 12 = 16$ so $r = \pm 4$. Since we are asked for $r \geq 0$, we choose $r = 4$. To find θ , we have that $\tan(\theta) = \frac{y}{x} = \frac{-2\sqrt{3}}{2} = -\sqrt{3}$. This tells us θ has a reference angle of $\frac{\pi}{3}$, and since P lies in Quadrant IV, we know θ is a Quadrant IV angle. We are asked to have $0 \leq \theta < 2\pi$, so we choose $\theta = \frac{5\pi}{3}$. Hence, our answer is $(4, \frac{5\pi}{3})$. To check, we convert $(r, \theta) = (4, \frac{5\pi}{3})$ back to rectangular coordinates and we find $x = r \cos(\theta) = 4 \cos(\frac{5\pi}{3}) = 4(\frac{1}{2}) = 2$ and $y = r \sin(\theta) = 4 \sin(\frac{5\pi}{3}) = 4(-\frac{\sqrt{3}}{2}) = -2\sqrt{3}$, as required.
2. The point $Q(-3, -3)$ lies in Quadrant III. Using $x = y = -3$, we get $r^2 = (-3)^2 + (-3)^2 = 18$ so $r = \pm\sqrt{18} = \pm 3\sqrt{2}$. Since we are asked for $r \geq 0$, we choose $r = 3\sqrt{2}$. We find $\tan(\theta) = \frac{-3}{-3} = 1$, which means θ has a reference angle of $\frac{\pi}{4}$. Since Q lies in Quadrant III, we choose $\theta = \frac{5\pi}{4}$, which satisfies the requirement that $0 \leq \theta < 2\pi$. Our final answer is $(r, \theta) = (3\sqrt{2}, \frac{5\pi}{4})$. To check, we find $x = r \cos(\theta) = (3\sqrt{2}) \cos(\frac{5\pi}{4}) = (3\sqrt{2})(-\frac{\sqrt{2}}{2}) = -3$ and $y = r \sin(\theta) = (3\sqrt{2}) \sin(\frac{5\pi}{4}) = (3\sqrt{2})(-\frac{\sqrt{2}}{2}) = -3$, so we are done.

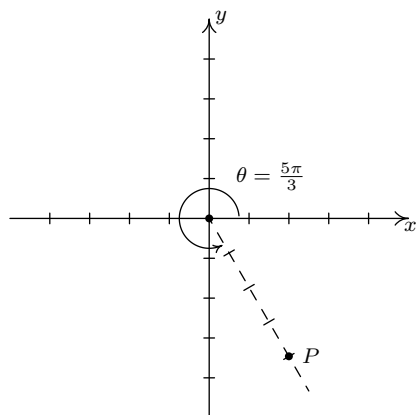

P has rectangular coordinates $(2, -2\sqrt{3})$
 P has polar coordinates $(4, \frac{5\pi}{3})$

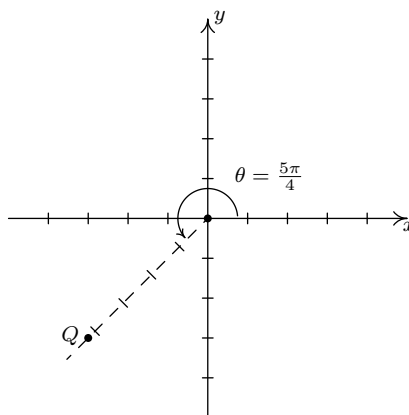

Q has rectangular coordinates $(-3, -3)$
 Q has polar coordinates $(3\sqrt{2}, \frac{5\pi}{4})$

3. The point $R(0, -3)$ lies along the negative y -axis. While we could go through the usual computations⁴ to find the polar form of R , in this case we can find the polar coordinates of R using the definition. Since the pole is identified with the origin, we can easily tell the point R is 3 units from the pole, which means in the polar representation (r, θ) of R we know $r = \pm 3$. Since we require $r \geq 0$, we choose $r = 3$. Concerning θ , the angle $\theta = \frac{3\pi}{2}$ satisfies $0 \leq \theta < 2\pi$

⁴Since $x = 0$, we would have to determine θ geometrically.

with its terminal side along the negative y -axis, so our answer is $(3, \frac{3\pi}{2})$. To check, we note $x = r \cos(\theta) = 3 \cos(\frac{3\pi}{2}) = (3)(0) = 0$ and $y = r \sin(\theta) = 3 \sin(\frac{3\pi}{2}) = 3(-1) = -3$.

4. The point $S(-3, 4)$ lies in Quadrant II. With $x = -3$ and $y = 4$, we get $r^2 = (-3)^2 + (4)^2 = 25$ so $r = \pm 5$. As usual, we choose $r = 5 \geq 0$ and proceed to determine θ . We have $\tan(\theta) = \frac{y}{x} = \frac{4}{-3} = -\frac{4}{3}$, and since this isn't the tangent of one of the common angles, we resort to using the arctangent function. Since θ lies in Quadrant II and must satisfy $0 \leq \theta < 2\pi$, we choose $\theta = \pi - \arctan(\frac{4}{3})$ radians. Hence, our answer is $(r, \theta) = (5, \pi - \arctan(\frac{4}{3})) \approx (5, 2.21)$. To check our answers requires a bit of tenacity since we need to simplify expressions of the form: $\cos(\pi - \arctan(\frac{4}{3}))$ and $\sin(\pi - \arctan(\frac{4}{3}))$. These are good review exercises and are hence left to the reader. We find $\cos(\pi - \arctan(\frac{4}{3})) = -\frac{3}{5}$ and $\sin(\pi - \arctan(\frac{4}{3})) = \frac{4}{5}$, so that $x = r \cos(\theta) = (5)(-\frac{3}{5}) = -3$ and $y = r \sin(\theta) = (5)(\frac{4}{5}) = 4$ which confirms our answer.

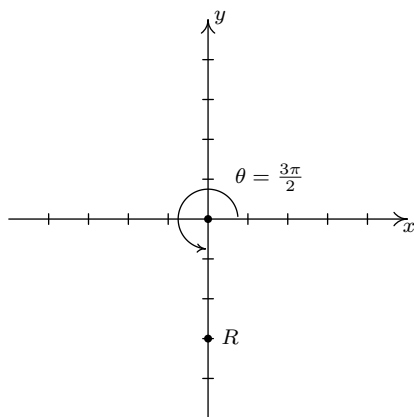

R has rectangular coordinates $(0, -3)$

R has polar coordinates $(3, \frac{3\pi}{2})$

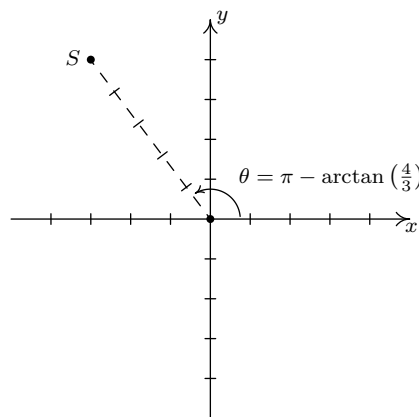

S has rectangular coordinates $(-3, 4)$

S has polar coordinates $(5, \pi - \arctan(\frac{4}{3}))$

□

Now that we've had practice converting representations of *points* between the rectangular and polar coordinate systems, we now set about converting *equations* from one system to another. Just as we've used equations in x and y to represent relations in rectangular coordinates, equations in the variables r and θ represent relations in polar coordinates. We convert equations between the two systems using Theorem 9.5 as the next example illustrates.

Example 9.3.3.

- Convert each equation in rectangular coordinates into an equation in polar coordinates.

(a) $(x - 3)^2 + y^2 = 9$

(b) $y = -x$

(c) $y = x^2$

- Convert each equation in polar coordinates into an equation in rectangular coordinates.

(a) $r = -3$

(b) $\theta = \frac{4\pi}{3}$

(c) $r = 1 - \cos(\theta)$

Solution.

1. One strategy to convert an equation from rectangular to polar coordinates is to replace every occurrence of x with $r \cos(\theta)$ and every occurrence of y with $r \sin(\theta)$ and use identities to simplify. This is the technique we employ below.

- (a) We start by substituting $x = r \cos(\theta)$ and $y = r \sin(\theta)$ into $(x-3)^2 + y^2 = 9$ and simplifying. With no real direction in which to proceed, we follow our mathematical instincts and see where they take us.⁵

$$\begin{aligned} (r \cos(\theta) - 3)^2 + (r \sin(\theta))^2 &= 9 \\ r^2 \cos^2(\theta) - 6r \cos(\theta) + 9 + r^2 \sin^2(\theta) &= 9 \\ r^2 (\cos^2(\theta) + \sin^2(\theta)) - 6r \cos(\theta) &= 0 && \text{Subtract 9 from both sides.} \\ r^2 - 6r \cos(\theta) &= 0 && \text{Since } \cos^2(\theta) + \sin^2(\theta) = 1 \\ r(r - 6 \cos(\theta)) &= 0 && \text{Factor.} \end{aligned}$$

We get $r = 0$ or $r = 6 \cos(\theta)$. From Section 0.10 we know the equation $(x-3)^2 + y^2 = 9$ describes a circle, and since $r = 0$ describes just a point (namely the pole/origin), we choose $r = 6 \cos(\theta)$ for our final answer.⁶

- (b) Substituting $x = r \cos(\theta)$ and $y = r \sin(\theta)$ into $y = -x$ gives $r \sin(\theta) = -r \cos(\theta)$. Rearranging, we get $r \cos(\theta) + r \sin(\theta) = 0$ or $r(\cos(\theta) + \sin(\theta)) = 0$. This gives $r = 0$ or $\cos(\theta) + \sin(\theta) = 0$. Solving the latter equation for θ , we get $\theta = -\frac{\pi}{4} + \pi k$ for integers k . As we did in the previous example, we take a step back and think geometrically. We know $y = -x$ describes a line through the origin. As before, $r = 0$ describes the origin, but nothing else. Consider the equation $\theta = -\frac{\pi}{4}$. In this equation, the variable r is free,⁷ meaning it can assume any and all values including $r = 0$. If we imagine plotting points $(r, -\frac{\pi}{4})$ for all conceivable values of r (positive, negative and zero), we are essentially drawing the line containing the terminal side of $\theta = -\frac{\pi}{4}$ which is none other than $y = -x$. Hence, we can take as our final answer $\theta = -\frac{\pi}{4}$ here.⁸
- (c) We substitute $x = r \cos(\theta)$ and $y = r \sin(\theta)$ into $y = x^2$ and get $r \sin(\theta) = (r \cos(\theta))^2$, or $r^2 \cos^2(\theta) - r \sin(\theta) = 0$. Factoring, we get $r(r \cos^2(\theta) - \sin(\theta)) = 0$ so that either $r = 0$ or $r \cos^2(\theta) = \sin(\theta)$. We can solve the latter equation for r by dividing both sides of the equation by $\cos^2(\theta)$, but as a general rule, we never divide through by a quantity that may be 0. In this particular case, we are safe since if $\cos^2(\theta) = 0$, then $\cos(\theta) = 0$, and for the equation $r \cos^2(\theta) = \sin(\theta)$ to hold, then $\sin(\theta)$ would also have to be 0. Since there are no angles with both $\cos(\theta) = 0$ and $\sin(\theta) = 0$, we are not losing any

⁵Experience is the mother of all instinct, and necessity is the mother of invention. Study this example and see what techniques are employed, then try your best to get your answers in the homework to match Jeff's.

⁶Note that when we substitute $\theta = \frac{\pi}{2}$ into $r = 6 \cos(\theta)$, we recover the point $r = 0$, so we aren't losing anything by disregarding $r = 0$.

⁷See Section 7.1.

⁸We could take it to be *any* of $\theta = -\frac{\pi}{4} + \pi k$ for integers k .

information by dividing both sides of $r \cos^2(\theta) = \sin(\theta)$ by $\cos^2(\theta)$. Doing so, we get $r = \frac{\sin(\theta)}{\cos^2(\theta)}$, or $r = \sec(\theta) \tan(\theta)$. As before, the $r = 0$ case is recovered in the solution $r = \sec(\theta) \tan(\theta)$ (let $\theta = 0$), so we state the latter as our final answer.

2. As a general rule, converting equations from polar to rectangular coordinates isn't as straight forward as the reverse process. We could solve $r^2 = x^2 + y^2$ for r to get $r = \pm\sqrt{x^2 + y^2}$ and solving $\tan(\theta) = \frac{y}{x}$ requires the arctangent function to get $\theta = \arctan\left(\frac{y}{x}\right) + \pi k$ for integers k . Neither of these expressions for r and θ are especially user-friendly, so we opt for a second strategy – rearrange the given polar equation so that the expressions $r^2 = x^2 + y^2$, $r \cos(\theta) = x$, $r \sin(\theta) = y$ and/or $\tan(\theta) = \frac{y}{x}$ present themselves.

- (a) Starting with $r = -3$, we can square both sides to get $r^2 = (-3)^2$ or $r^2 = 9$. We may now substitute $r^2 = x^2 + y^2$ to get the equation $x^2 + y^2 = 9$. As we have seen,⁹ squaring an equation does not, in general, produce an equivalent equation. The concern here is that the equation $r^2 = 9$ might be satisfied by more points than $r = -3$. On the surface, this appears to be the case since $r^2 = 9$ is equivalent to $r = \pm 3$, not just $r = -3$. However, any point with polar coordinates $(3, \theta)$ can be represented as $(-3, \theta + \pi)$, which means any point (r, θ) whose polar coordinates satisfy the relation $r = \pm 3$ has an equivalent¹⁰ representation which satisfies $r = -3$.
- (b) We take the tangent of both sides the equation $\theta = \frac{4\pi}{3}$ to get $\tan(\theta) = \tan\left(\frac{4\pi}{3}\right) = \sqrt{3}$. Since $\tan(\theta) = \frac{y}{x}$, we get $\frac{y}{x} = \sqrt{3}$ or $y = x\sqrt{3}$. Of course, we pause a moment to wonder if, geometrically, the equations $\theta = \frac{4\pi}{3}$ and $y = x\sqrt{3}$ generate the same set of points.¹¹ The same argument presented in number 1b applies equally well here so we are done.
- (c) Once again, we need to manipulate $r = 1 - \cos(\theta)$ a bit before using the conversion formulas given in Theorem 9.5. We could square both sides of this equation like we did in part 2a above to obtain an r^2 on the left hand side, but that does nothing helpful for the right hand side. Instead, we multiply both sides by r to obtain $r^2 = r - r \cos(\theta)$. We now have an r^2 and an $r \cos(\theta)$ in the equation, which we can easily handle, but we also have another r to deal with. Rewriting the equation as $r = r^2 + r \cos(\theta)$ and squaring both sides yields $r^2 = (r^2 + r \cos(\theta))^2$. Substituting $r^2 = x^2 + y^2$ and $r \cos(\theta) = x$ gives $x^2 + y^2 = (x^2 + y^2 + x)^2$. Once again, we have performed some

⁹Exercise 5.3.1 in Section 5.3, for instance ...

¹⁰Here, 'equivalent' means they represent the same point in the plane. As ordered pairs, $(3, 0)$ and $(-3, \pi)$ are different, but when interpreted as polar coordinates, they correspond to the same point in the plane. Mathematically speaking, relations are sets of ordered pairs, so the equations $r^2 = 9$ and $r = -3$ represent different relations since they correspond to different sets of ordered pairs. Since polar coordinates were defined geometrically to describe the location of points in the plane, however, we concern ourselves only with ensuring that the sets of *points* in the plane generated by two equations are the same. This was not an issue, by the way, when we first defined relations as sets of points in the plane in Section 1.2. Back then, a point in the plane was identified with a unique ordered pair given by its Cartesian coordinates.

¹¹In addition to taking the tangent of both sides of an equation (There are infinitely many solutions to $\tan(\theta) = \sqrt{3}$, and $\theta = \frac{4\pi}{3}$ is only one of them!), we also went from $\frac{y}{x} = \sqrt{3}$, in which x cannot be 0, to $y = x\sqrt{3}$ in which we assume x can be 0.

algebraic maneuvers which may have altered the set of points described by the original equation. First, we multiplied both sides by r . This means that now $r = 0$ is a viable solution to the equation. In the original equation, $r = 1 - \cos(\theta)$, we see that $\theta = 0$ gives $r = 0$, so the multiplication by r doesn't introduce any new points. The squaring of both sides of this equation is also a reason to pause. Are there points with coordinates (r, θ) which satisfy $r^2 = (r^2 + r \cos(\theta))^2$ but do not satisfy $r = r^2 + r \cos(\theta)$? Suppose (r', θ') satisfies $r^2 = (r^2 + r \cos(\theta))^2$. Then $r' = \pm ((r')^2 + r' \cos(\theta'))$. If we have that $r' = (r')^2 + r' \cos(\theta')$, we are done. What if $r' = -((r')^2 + r' \cos(\theta')) = -(r')^2 - r' \cos(\theta')$? We claim that the coordinates $(-r', \theta' + \pi)$, which determine the same point as (r', θ') , satisfy $r = r^2 + r \cos(\theta)$. We substitute $r = -r'$ and $\theta = \theta' + \pi$ into $r = r^2 + r \cos(\theta)$ to see if we get a true statement.

$$\begin{aligned}
 -r' &\stackrel{?}{=} (-r')^2 + (-r' \cos(\theta' + \pi)) \\
 -((r')^2 - r' \cos(\theta')) &\stackrel{?}{=} (r')^2 - r' \cos(\theta' + \pi) && \text{Since } r' = -(r')^2 - r' \cos(\theta') \\
 (r')^2 + r' \cos(\theta') &\stackrel{?}{=} (r')^2 - r'(-\cos(\theta')) && \text{Since } \cos(\theta' + \pi) = -\cos(\theta') \\
 (r')^2 + r' \cos(\theta') &\stackrel{\checkmark}{=} (r')^2 + r' \cos(\theta')
 \end{aligned}$$

Since both sides worked out to be equal, $(-r', \theta' + \pi)$ satisfies $r = r^2 + r \cos(\theta)$ which means that any point (r, θ) which satisfies $r^2 = (r^2 + r \cos(\theta))^2$ has a representation which satisfies $r = r^2 + r \cos(\theta)$, and we are done. \square

In practice, much of the pedantic verification of the equivalence of equations in Example 9.3.3 is left unsaid. Indeed, in most textbooks, squaring equations like $r = -3$ to arrive at $r^2 = 9$ happens without a second thought. Your instructor will ultimately decide how much, if any, justification is warranted. If you take anything away from Example 9.3.3, it should be that relatively nice things in rectangular coordinates, such as $y = x^2$, can turn ugly in polar coordinates, and vice-versa. In the next section, we devote our attention to graphing equations like the ones given in Example 9.3.3 number 2 on the Cartesian coordinate plane without converting back to rectangular coordinates. If nothing else, number 2c above shows the price we pay if we insist on always converting to back to the more familiar rectangular coordinate system.

9.3.1 EXERCISES

In Exercises 1 - 16, plot the point given in polar coordinates and then give three different expressions for the point such that (a) $r < 0$ and $0 \leq \theta \leq 2\pi$, (b) $r > 0$ and $\theta \leq 0$ (c) $r > 0$ and $\theta \geq 2\pi$

- | | | | |
|---|---|---|---|
| 1. $\left(2, \frac{\pi}{3}\right)$ | 2. $\left(5, \frac{7\pi}{4}\right)$ | 3. $\left(\frac{1}{3}, \frac{3\pi}{2}\right)$ | 4. $\left(\frac{5}{2}, \frac{5\pi}{6}\right)$ |
| 5. $\left(12, -\frac{7\pi}{6}\right)$ | 6. $\left(3, -\frac{5\pi}{4}\right)$ | 7. $(2\sqrt{2}, -\pi)$ | 8. $\left(\frac{7}{2}, -\frac{13\pi}{6}\right)$ |
| 9. $(-20, 3\pi)$ | 10. $\left(-4, \frac{5\pi}{4}\right)$ | 11. $\left(-1, \frac{2\pi}{3}\right)$ | 12. $\left(-3, \frac{\pi}{2}\right)$ |
| 13. $\left(-3, -\frac{11\pi}{6}\right)$ | 14. $\left(-2.5, -\frac{\pi}{4}\right)$ | 15. $\left(-\sqrt{5}, -\frac{4\pi}{3}\right)$ | 16. $(-\pi, -\pi)$ |

In Exercises 17 - 36, convert the point from polar coordinates into rectangular coordinates.

- | | | | |
|--|--|--|--|
| 17. $\left(5, \frac{7\pi}{4}\right)$ | 18. $\left(2, \frac{\pi}{3}\right)$ | 19. $\left(11, -\frac{7\pi}{6}\right)$ | 20. $(-20, 3\pi)$ |
| 21. $\left(\frac{3}{5}, \frac{\pi}{2}\right)$ | 22. $\left(-4, \frac{5\pi}{6}\right)$ | 23. $\left(9, \frac{7\pi}{2}\right)$ | 24. $\left(-5, -\frac{9\pi}{4}\right)$ |
| 25. $\left(42, \frac{13\pi}{6}\right)$ | 26. $(-117, 117\pi)$ | 27. $(6, \arctan(2))$ | 28. $(10, \arctan(3))$ |
| 29. $\left(-3, \arctan\left(\frac{4}{3}\right)\right)$ | 30. $\left(5, \arctan\left(-\frac{4}{3}\right)\right)$ | | |
| 31. $\left(2, \pi - \arctan\left(\frac{1}{2}\right)\right)$ | 32. $\left(-\frac{1}{2}, \pi - \arctan(5)\right)$ | | |
| 33. $\left(-1, \pi + \arctan\left(\frac{3}{4}\right)\right)$ | 34. $\left(\frac{2}{3}, \pi + \arctan(2\sqrt{2})\right)$ | | |
| 35. $(\pi, \arctan(\pi))$ | 36. $\left(13, \arctan\left(\frac{12}{5}\right)\right)$ | | |

In Exercises 37 - 56, convert the point from rectangular coordinates into polar coordinates with $r \geq 0$ and $0 \leq \theta < 2\pi$.

- | | | | |
|---------------|-----------------------------|------------------------|---|
| 37. $(0, 5)$ | 38. $(3, \sqrt{3})$ | 39. $(7, -7)$ | 40. $(-3, -\sqrt{3})$ |
| 41. $(-3, 0)$ | 42. $(-\sqrt{2}, \sqrt{2})$ | 43. $(-4, -4\sqrt{3})$ | 44. $\left(\frac{\sqrt{3}}{4}, -\frac{1}{4}\right)$ |

45. $\left(-\frac{3}{10}, -\frac{3\sqrt{3}}{10}\right)$	46. $(-\sqrt{5}, -\sqrt{5})$	47. $(6, 8)$	48. $(\sqrt{5}, 2\sqrt{5})$
49. $(-8, 1)$	50. $(-2\sqrt{10}, 6\sqrt{10})$	51. $(-5, -12)$	52. $\left(-\frac{\sqrt{5}}{15}, -\frac{2\sqrt{5}}{15}\right)$
53. $(24, -7)$	54. $(12, -9)$	55. $\left(\frac{\sqrt{2}}{4}, \frac{\sqrt{6}}{4}\right)$	56. $\left(-\frac{\sqrt{65}}{5}, \frac{2\sqrt{65}}{5}\right)$

In Exercises 57 - 76, convert the equation from rectangular coordinates into polar coordinates. Solve for r in all but #60 through #63. In Exercises 60 - 63, you need to solve for θ

57. $x = 6$	58. $x = -3$	59. $y = 7$	60. $y = 0$
61. $y = -x$	62. $y = x\sqrt{3}$	63. $y = 2x$	64. $x^2 + y^2 = 25$
65. $x^2 + y^2 = 117$	66. $y = 4x - 19$	67. $x = 3y + 1$	68. $y = -3x^2$
69. $4x = y^2$	70. $x^2 + y^2 - 2y = 0$	71. $x^2 - 4x + y^2 = 0$	72. $x^2 + y^2 = x$
73. $y^2 = 7y - x^2$		74. $(x + 2)^2 + y^2 = 4$	
75. $x^2 + (y - 3)^2 = 9$		76. $4x^2 + 4\left(y - \frac{1}{2}\right)^2 = 1$	

In Exercises 77 - 96, convert the equation from polar coordinates into rectangular coordinates.

77. $r = 7$	78. $r = -3$	79. $r = \sqrt{2}$	80. $\theta = \frac{\pi}{4}$
81. $\theta = \frac{2\pi}{3}$	82. $\theta = \pi$	83. $\theta = \frac{3\pi}{2}$	84. $r = 4 \cos(\theta)$
85. $5r = \cos(\theta)$	86. $r = 3 \sin(\theta)$	87. $r = -2 \sin(\theta)$	88. $r = 7 \sec(\theta)$
89. $12r = \csc(\theta)$	90. $r = -2 \sec(\theta)$	91. $r = -\sqrt{5} \csc(\theta)$	92. $r = 2 \sec(\theta) \tan(\theta)$
93. $r = -\csc(\theta) \cot(\theta)$	94. $r^2 = \sin(2\theta)$	95. $r = 1 - 2 \cos(\theta)$	96. $r = 1 + \sin(\theta)$

97. Convert the origin $(0, 0)$ into polar coordinates in four different ways.

98. With the help of your classmates, use the Law of Cosines to develop a formula for the distance between two points in polar coordinates.

9.3.2 ANSWERS

$$1. \left(2, \frac{\pi}{3}\right), \left(-2, \frac{4\pi}{3}\right)$$

$$\left(2, -\frac{5\pi}{3}\right), \left(2, \frac{7\pi}{3}\right)$$

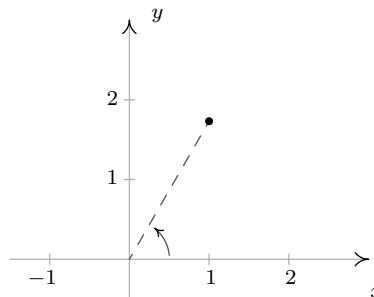

$$2. \left(5, \frac{7\pi}{4}\right), \left(-5, \frac{3\pi}{4}\right)$$

$$\left(5, -\frac{\pi}{4}\right), \left(5, \frac{15\pi}{4}\right)$$

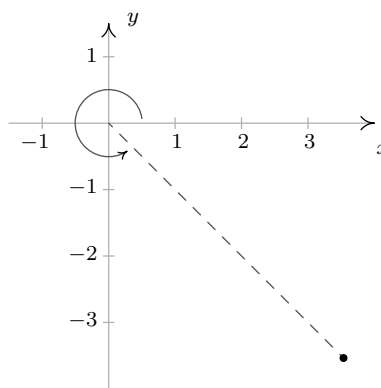

$$3. \left(\frac{1}{3}, \frac{3\pi}{2}\right), \left(-\frac{1}{3}, \frac{\pi}{2}\right)$$

$$\left(\frac{1}{3}, -\frac{\pi}{2}\right), \left(\frac{1}{3}, \frac{7\pi}{2}\right)$$

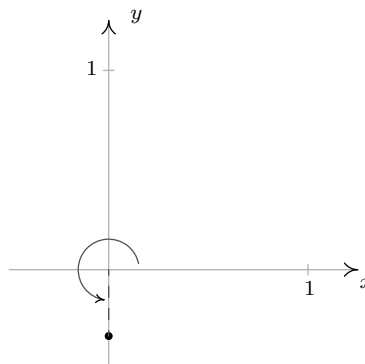

$$4. \left(\frac{5}{2}, \frac{5\pi}{6}\right), \left(-\frac{5}{2}, \frac{11\pi}{6}\right)$$

$$\left(\frac{5}{2}, -\frac{7\pi}{6}\right), \left(\frac{5}{2}, \frac{17\pi}{6}\right)$$

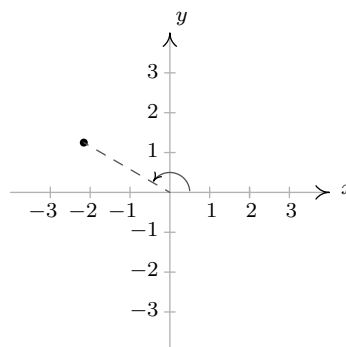

$$5. \left(12, -\frac{7\pi}{6}\right), \left(-12, \frac{11\pi}{6}\right)$$

$$\left(12, -\frac{19\pi}{6}\right), \left(12, \frac{17\pi}{6}\right)$$

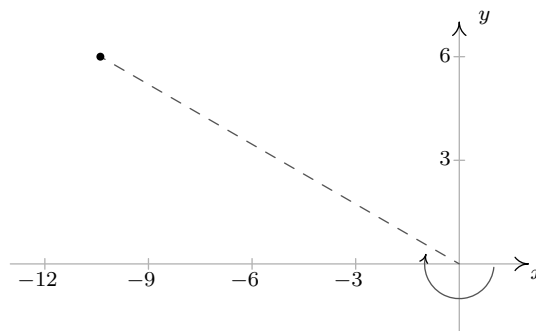

$$6. \left(3, -\frac{5\pi}{4}\right), \left(-3, \frac{7\pi}{4}\right)$$

$$\left(3, -\frac{13\pi}{4}\right), \left(3, \frac{11\pi}{4}\right)$$

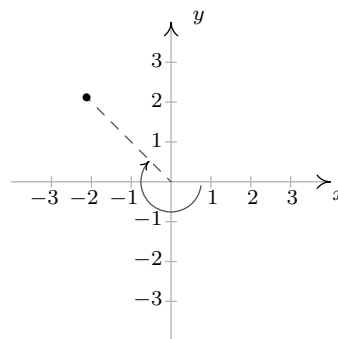

$$7. (2\sqrt{2}, -\pi), (-2\sqrt{2}, 0)$$

$$(2\sqrt{2}, -3\pi), (2\sqrt{2}, 3\pi)$$

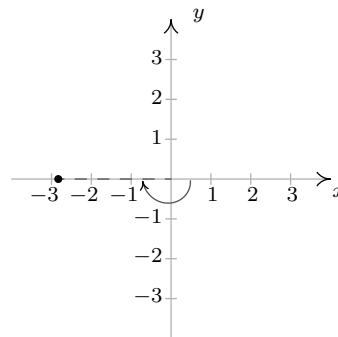

$$8. \left(\frac{7}{2}, -\frac{13\pi}{6}\right), \left(-\frac{7}{2}, \frac{5\pi}{6}\right)$$

$$\left(\frac{7}{2}, -\frac{\pi}{6}\right), \left(\frac{7}{2}, \frac{23\pi}{6}\right)$$

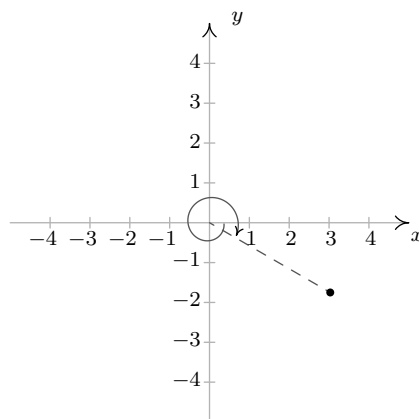

9. $(-20, 3\pi), (-20, \pi)$
 $(20, -2\pi), (20, 4\pi)$

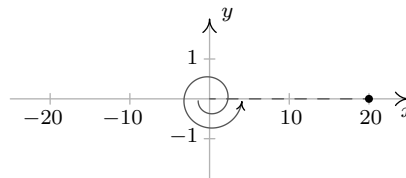

10. $\left(-4, \frac{5\pi}{4}\right), \left(-4, \frac{5\pi}{4}\right)$
 $\left(4, -\frac{7\pi}{4}\right), \left(4, \frac{9\pi}{4}\right)$

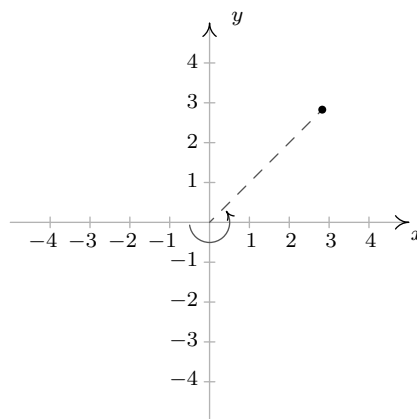

11. $\left(-1, \frac{2\pi}{3}\right), \left(-1, \frac{2\pi}{3}\right)$
 $\left(1, -\frac{\pi}{3}\right), \left(1, \frac{11\pi}{3}\right)$

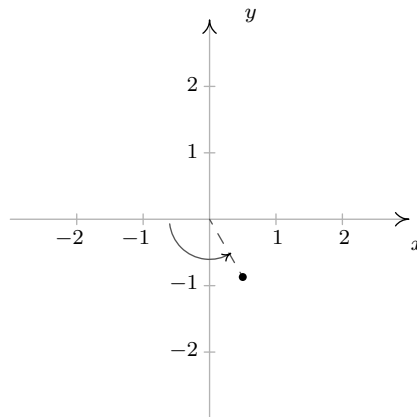

12. $\left(-3, \frac{\pi}{2}\right), \left(-3, \frac{\pi}{2}\right)$
 $\left(3, -\frac{\pi}{2}\right), \left(3, \frac{7\pi}{2}\right)$

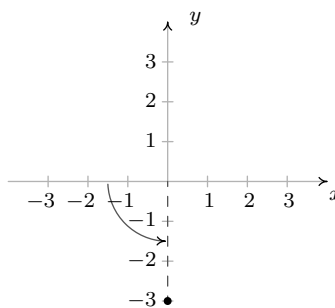

$$13. \left(-3, -\frac{11\pi}{6}\right), \left(-3, \frac{\pi}{6}\right)$$

$$\left(3, -\frac{5\pi}{6}\right), \left(3, \frac{19\pi}{6}\right)$$

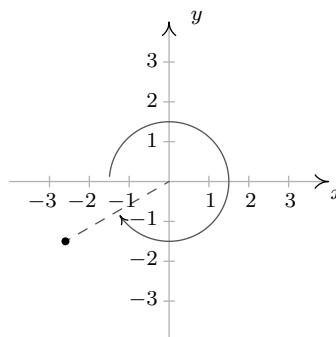

$$14. \left(-2.5, -\frac{\pi}{4}\right), \left(-2.5, \frac{7\pi}{4}\right)$$

$$\left(2.5, -\frac{5\pi}{4}\right), \left(2.5, \frac{11\pi}{4}\right)$$

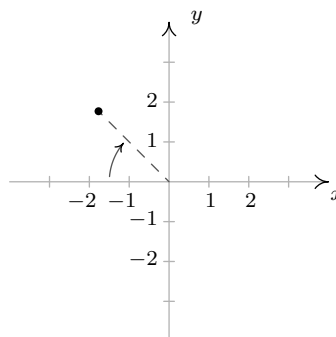

$$15. \left(-\sqrt{5}, -\frac{4\pi}{3}\right), \left(-\sqrt{5}, \frac{2\pi}{3}\right)$$

$$\left(\sqrt{5}, -\frac{\pi}{3}\right), \left(\sqrt{5}, \frac{11\pi}{3}\right)$$

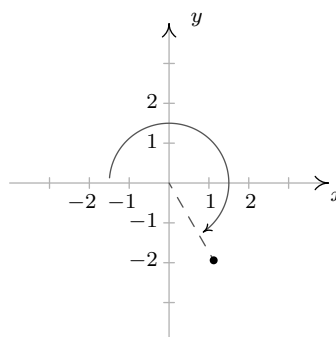

$$16. (-\pi, -\pi), (-\pi, \pi)$$

$$(\pi, -2\pi), (\pi, 2\pi)$$

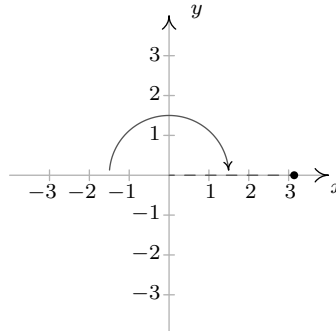

17. $\left(\frac{5\sqrt{2}}{2}, -\frac{5\sqrt{2}}{2}\right)$ 18. $(1, \sqrt{3})$ 19. $\left(-\frac{11\sqrt{3}}{2}, \frac{11}{2}\right)$ 20. $(20, 0)$
21. $\left(0, \frac{3}{5}\right)$ 22. $(2\sqrt{3}, -2)$ 23. $(0, -9)$ 24. $\left(-\frac{5\sqrt{2}}{2}, \frac{5\sqrt{2}}{2}\right)$
25. $(21\sqrt{3}, 21)$ 26. $(117, 0)$ 27. $\left(\frac{6\sqrt{5}}{5}, \frac{12\sqrt{5}}{5}\right)$ 28. $(\sqrt{10}, 3\sqrt{10})$
29. $\left(-\frac{9}{5}, -\frac{12}{5}\right)$ 30. $(3, -4)$ 31. $\left(-\frac{4\sqrt{5}}{5}, \frac{2\sqrt{5}}{5}\right)$ 32. $\left(\frac{\sqrt{26}}{52}, -\frac{5\sqrt{26}}{52}\right)$
33. $\left(\frac{4}{5}, \frac{3}{5}\right)$ 34. $\left(-\frac{2}{9}, -\frac{4\sqrt{2}}{9}\right)$ 35. $\left(\frac{\pi}{\sqrt{1+\pi^2}}, \frac{\pi^2}{\sqrt{1+\pi^2}}\right)$ 36. $(5, 12)$
37. $\left(5, \frac{\pi}{2}\right)$ 38. $\left(2\sqrt{3}, \frac{\pi}{6}\right)$ 39. $\left(7\sqrt{2}, \frac{7\pi}{4}\right)$ 40. $\left(2\sqrt{3}, \frac{7\pi}{6}\right)$
41. $(3, \pi)$ 42. $\left(2, \frac{3\pi}{4}\right)$ 43. $\left(8, \frac{4\pi}{3}\right)$ 44. $\left(\frac{1}{2}, \frac{11\pi}{6}\right)$
45. $\left(\frac{3}{5}, \frac{4\pi}{3}\right)$ 46. $\left(\sqrt{10}, \frac{5\pi}{4}\right)$ 47. $\left(10, \arctan\left(\frac{4}{3}\right)\right)$ 48. $(5, \arctan(2))$
49. $\left(\sqrt{65}, \pi - \arctan\left(\frac{1}{8}\right)\right)$ 50. $(20, \pi - \arctan(3))$
51. $\left(13, \pi + \arctan\left(\frac{12}{5}\right)\right)$ 52. $\left(\frac{1}{3}, \pi + \arctan(2)\right)$
53. $\left(25, 2\pi - \arctan\left(\frac{7}{24}\right)\right)$ 54. $\left(15, 2\pi - \arctan\left(\frac{3}{4}\right)\right)$
55. $\left(\frac{\sqrt{2}}{2}, \frac{\pi}{3}\right)$ 56. $(\sqrt{13}, \pi - \arctan(2))$
57. $r = 6 \sec(\theta)$ 58. $r = -3 \sec(\theta)$ 59. $r = 7 \csc(\theta)$ 60. $\theta = 0$
61. $\theta = \frac{3\pi}{4}$ 62. $\theta = \frac{\pi}{3}$ 63. $\theta = \arctan(2)$ 64. $r = 5$
65. $r = \sqrt{117}$ 66. $r = \frac{19}{4 \cos(\theta) - \sin(\theta)}$ 67. $x = \frac{1}{\cos(\theta) - 3 \sin(\theta)}$ 68. $r = \frac{-\sec(\theta) \tan(\theta)}{3}$
69. $r = 4 \csc(\theta) \cot(\theta)$ 70. $r = 2 \sin(\theta)$ 71. $r = 4 \cos(\theta)$ 72. $r = \cos(\theta)$

73. $r = 7 \sin(\theta)$

74. $r = -4 \cos(\theta)$

75. $r = 6 \sin(\theta)$

76. $r = \sin(\theta)$

77. $x^2 + y^2 = 49$

78. $x^2 + y^2 = 9$

79. $x^2 + y^2 = 2$

80. $y = x$

81. $y = -\sqrt{3}x$

82. $y = 0$

83. $x = 0$

84. $x^2 + y^2 = 4x$ or $(x - 2)^2 + y^2 = 4$

85. $5x^2 + 5y^2 = x$ or $\left(x - \frac{1}{10}\right)^2 + y^2 = \frac{1}{100}$

86. $x^2 + y^2 = 3y$ or $x^2 + \left(y - \frac{3}{2}\right)^2 = \frac{9}{4}$

87. $x^2 + y^2 = -2y$ or $x^2 + (y + 1)^2 = 1$

88. $x = 7$

89. $y = \frac{1}{12}$

90. $x = -2$

91. $y = -\sqrt{5}$

92. $x^2 = 2y$

93. $y^2 = -x$

94. $(x^2 + y^2)^2 = 2xy$

95. $(x^2 + 2x + y^2)^2 = x^2 + y^2$

96. $(x^2 + y^2 - y)^2 = x^2 + y^2$

97. Any point of the form $(0, \theta)$ will work, e.g. $(0, \pi)$, $(0, -117)$, $\left(0, \frac{23\pi}{4}\right)$ and $(0, 0)$.

INDEX

- \in , 3
- \notin , 3
- n^{th} root
 - principal, 32
- n^{th} root
 - principal, 531
- u -substitution, 407
- x -axis, 140
- x -coordinate, 140
- x -intercept, 159
- y -axis, 140
- y -coordinate, 140
- y -intercept, 159

- abscissa, 140
- absolute value, 52
- absolute value
 - definition of, 307
 - inequality, 55, 345
 - properties of, 52, 307
- acidity of a solution
 - pH, 566
- acute angle, 662
- alkalinity of a solution
 - pH, 566
- amplitude, 762, 849
- angle
 - acute, 662
 - central angle, 669
 - complementary, 664
 - coterminal, 666
 - decimal degrees, 663
 - definition, 661
 - degree, 662
 - DMS, 663
 - initial side, 666
 - measurement, 661
 - negative, 666
 - obtuse, 662
 - of declination, 729
 - of depression, 729
 - of elevation, 721
 - of inclination, 721
 - oriented, 665
 - positive, 666
 - quadrantal, 666
 - radian measure, 669
 - reference, 689
 - right, 662
 - standard position, 666
 - straight, 661
 - supplementary, 664
 - terminal side, 666
 - vertex, 661
- angle side opposite pairs, 864
- angular frequency, 676
- applied domain of a function, 194
- arccosecant
 - calculus friendly
 - definition of, 799
 - graph of, 798
 - properties of, 799
 - trigonometry friendly
 - definition of, 796
 - graph of, 795
 - properties of, 796

- arccosine
 - definition of, 788
 - graph of, 787
 - properties of, 788
- arccotangent
 - definition of, 792
 - graph of, 792
 - properties of, 792
- arcsecant
 - calculus friendly
 - definition of, 799
 - graph of, 798
 - properties of, 799
 - trigonometry friendly
 - definition of, 796
 - graph of, 795
 - properties of, 796
- arcsine
 - definition of, 788
 - graph of, 788
 - properties of, 788
- arctangent
 - definition of, 792
 - graph of, 791
 - properties of, 792
- argument
 - of a function, 189
 - of a logarithm, 559
 - of a trigonometric function, 761
- associative property
 - for function composition, 500
- asymptote
 - horizontal
 - formal definition of, 438
 - intuitive definition of, 438
 - location of, 442
 - slant
 - determination of, 446
 - formal definition of, 445
 - slant (oblique), 445
 - vertical
 - formal definition of, 438
 - intuitive definition of, 438
 - location of, 440
- average angular velocity, 675
- average cost, 480
- average cost function, 216
- average rate of change, 294
- average velocity, 674
- axis of symmetry, 325
- back substitution, 640
- base, 27
- bearings, 873
- binomial, 61
- Bisection Method, 411
- BMI, body mass index, 489
- Boyle's Law, 484
- buffer solution, 612
- Cartesian coordinate plane, 140
- Cartesian coordinates, 140
- Cauchy's Bound, 403
- center
 - of a circle, 127
- central angle, 669
- change of base formulas, 576
- Charles's Law, 489
- circle
 - center of, 127
 - definition of, 127
 - radius of, 127
 - standard equation, 127
- circular function, 712
- coefficient of determination, 360
- Cofunction Identities, 741
- common base, 554
- common logarithm, 556
- commutative property
 - function composition does not have, 500
- complementary angles, 664
- Completing the Square, 85
- Complex Factorization Theorem, 424
- complex number
 - conjugate

- definition of, 422
- properties of, 423
- definition of, 136, 421
- imaginary unit, i , 421
- set of, 136
- composite function
 - definition of, 494
 - properties of, 501
- compound interest, 604
- conjugate, 121
- conjugate of a complex number
 - definition of, 422
 - properties of, 423
- Conjugate Pairs Theorem, 425
- consistent system, 633
- constant function
 - as a horizontal line, 290
 - formal definition of, 235
 - intuitive definition of, 234
- constant of proportionality, 484
- constant term of a polynomial, 370
- continuous, 375
- continuously compounded interest, 606
- contradiction, 629
- coordinates
 - Cartesian, 140
 - polar, 878
 - rectangular, 878
- correlation coefficient, 360
- cosecant
 - graph of, 769
 - of an angle, 712, 720
 - properties of, 770
- cosine
 - graph of, 759
 - of an angle, 685, 698, 712
 - properties of, 759
- cost
 - average, 216, 480
 - fixed, start-up, 216
 - variable, 293
- cost function, 216
- cotangent
 - graph of, 773
 - of an angle, 712, 720
 - properties of, 774
- coterminal angle, 666
- Coulomb's Law, 489
- decibel, 565
- decimal degrees, 663
- decreasing function
 - formal definition of, 235
 - intuitive definition of, 234
- degree measure, 662
- degree of a polynomial, 370
- dependent system, 634
- dependent variable, 189
- depreciation, 554
- Descartes' Rule of Signs, 407
- diagram
 - Venn Diagram, 4
- Difference Identity
 - for cosine, 739, 743
 - for sine, 741, 743
 - for tangent, 743
- difference quotient, 213
- direct variation, 484
- discriminant, 93
- discriminant
 - of a quadratic equation, 329
 - trichotomy, 329
- distance
 - definition, 144
 - distance formula, 145
- division
 - dividend, 65
 - divisor, 65
 - quotient, 65
 - remainder, 65
- DMS, 663
- domain
 - applied, 194
 - definition of, 179
 - implied, 192

- Double Angle Identities, 744
- earthquake
 - Richter Scale, 565
- ellipsis (...), 165
- empty set, 4, 136
- end behavior
 - of $f(x) = ax^n$, n even, 374
 - of $f(x) = ax^n$, n odd, 374
 - of a function graph, 373
 - polynomial, 377
- equation
 - conditional, 39
 - contradiction, 39, 629
 - equivalent, 39
 - graph of, 157
 - identity, 39, 629
 - linear, 39
 - linear of n variables, 634
 - linear of two variables, 629
 - quadratic, 84
 - quadratic
 - discriminant, 93
 - quadratic in form, 91
- equations
 - quadratic, 84
- even function, 229
- Even/Odd Identities, 738
- exponent, 27
- exponential function
 - algebraic properties of, 571
 - change of base formula, 576
 - common base, 554
 - definition of, 552
 - graphical properties of, 553
 - inverse properties of, 571
 - natural base, 554
 - one-to-one properties of, 571
 - solving equations with, 582
- extended interval notation, 724
- Factor Theorem, 392
- fixed cost, 216
- formula
 - quadratic, 87
- free variable, 632
- frequency
 - angular, 676, 849
 - of a sinusoid, 763
 - ordinary, 676, 849
- function
 - (absolute) maximum, 235
 - (absolute, global) minimum, 235
 - absolute value, 307
 - algebraic, 533
 - argument, 189
 - arithmetic, 210
 - as a process, 189, 512
 - average cost, 216
 - circular, 712
 - composite
 - definition of, 494
 - properties of, 501
 - constant, 234, 290
 - continuous, 375
 - cost, 216
 - decreasing, 234
 - definition as a relation, 177
 - dependent variable of, 189
 - difference, 210
 - difference quotient, 213
 - domain, 179
 - even, 229
 - exponential, 552
 - Fundamental Graphing Principle, 227
 - identity, 302
 - increasing, 234
 - independent variable of, 189
 - inverse
 - definition of, 513
 - properties of, 513
 - solving for, 518
 - uniqueness of, 514
 - linear, 290
 - local (relative) maximum, 235

- local (relative) minimum, 235
 - logarithmic, 556
 - notation, 189
 - odd, 229
 - one-to-one, 515
 - periodic, 758
 - piecewise-defined, 196
 - polynomial, 369
 - price-demand, 216
 - product, 210
 - profit, 216
 - quadratic, 322
 - quotient, 210
 - range, 179
 - rational, 435
 - revenue, 216
 - smooth, 375
 - sum, 210
 - transformation of graphs, 254, 269
 - zero, 229
- fundamental cycle
- of $y = \cos(x)$, 759
- Fundamental Graphing Principle
- for equations, 157
 - for functions, 227
- Fundamental Theorem of Algebra, 424
- Gaussian Elimination, 637
- graph
- hole in, 439
 - horizontal scaling, 266
 - horizontal shift, 257
 - of a function, 227
 - of a relation, 154
 - of an equation, 157
 - rational function, 455
 - reflection about an axis, 260
 - transformations, 269
 - vertical scaling, 264
 - vertical shift, 255
- greatest integer function, 201
- growth model
- limited, 609
 - logistic, 609
 - uninhibited, 606
- Half-Angle Formulas, 747
- harmonic motion, 853
- Henderson-Hasselbalch Equation, 580
- hole
- in a graph, 439
 - location of, 440
- Hooke's Law, 484
- horizontal asymptote
- formal definition of, 438
 - intuitive definition of, 438
 - location of, 442
- horizontal line, 157
- Horizontal Line Test (HLT), 515
- identity
- function, 501
 - statement which is always true, 629
- imaginary unit, i , 421
- implied domain of a function, 192
- inconsistent system, 633
- increasing function
- formal definition of, 235
 - intuitive definition of, 234
- independent system, 634
- independent variable, 189
- index of a root, 32, 531
- inequality
- absolute value, 55, 345
 - conditional, 39
 - contradiction, 39
 - equivalent, 39
 - graphical interpretation, 343
 - identity, 39
 - non-linear, 653
 - quadratic, 349
 - sign diagram, 348
- inflection point, 611
- information entropy, 611
- initial side of an angle, 666
- instantaneous rate of change, 295, 606, 675

- integer
 - definition of, 6, 136
 - greatest integer function, 201
 - set of, 6, 136
- intercept
 - definition of, 159
 - location of, 159
- interest
 - compound, 604
 - compounded continuously, 606
 - simple, 603
- Intermediate Value Theorem
 - polynomial zero version, 375
- interrobang, 455
- intersection of two sets, 4, 138
- interval
 - definition of, 9, 137
 - notation for, 9, 137
 - notation, extended, 724
- inverse
 - of a function
 - definition of, 513
 - properties of, 513
 - solving for, 518
 - uniqueness of, 514
- inverse variation, 484
- invertibility
 - function, 516
- invertible
 - function, 513
- irrational number
 - definition of, 6, 136
 - set of, 6, 136
- irreducible quadratic, 425

- joint variation, 484

- Kepler's Third Law of Planetary Motion, 489

- Law of Sines, 865
- leading coefficient of a polynomial, 370
- leading term of a polynomial, 370
- Learning Curve Equation, 449

- least squares regression line, 359
- line
 - horizontal, 157
 - least squares regression, 359
 - linear function, 290
 - of best fit, 359
 - parallel, 300
 - perpendicular, 301
 - point-slope form, 289
 - slope of, 285
 - slope-intercept form, 289
 - vertical, 157
- linear equation
 - n variables, 634
 - two variables, 629
- linear function, 290
- local maximum
 - formal definition of, 236
 - intuitive definition of, 235
- local minimum
 - formal definition of, 236
 - intuitive definition of, 235
- logarithm
 - algebraic properties of, 572
 - change of base formula, 576
 - common, 556
 - general, "base b ", 556
 - graphical properties of, 557
 - inverse properties of, 571
 - natural, 556
 - one-to-one properties of, 571
 - solving equations with, 593
- logarithmic scales, 565
- logistic growth, 609

- mathematical model, 194
- maximum
 - formal definition of, 236
 - intuitive definition of, 235
- measure of an angle, 661
- midpoint
 - definition of, 146
 - midpoint formula, 147

- minimum
 - formal definition of, 236
 - intuitive definition of, 235
- model
 - mathematical, 194
- monomial, 61
- multiplicity
 - effect on the graph of a polynomial, 379, 383
 - of a zero, 378
- natural base, 554
- natural logarithm, 556
- natural number
 - definition of, 6, 136
 - set of, 6, 136
- negative angle, 666
- Newton's Law of Cooling, 555, 608
- Newton's Law of Universal Gravitation, 485
- number
 - prime, 71
 - prime factorization, 71
- oblique asymptote, 445
- obtuse angle, 662
- odd function, 229
- Ohm's Law, 484
- one-to-one function, 515
- ordered pair, 140
- ordinary frequency, 676
- ordinate, 140
- oriented angle, 665
- oriented arc, 672
- origin, 141
- overdetermined system, 634
- parabola
 - axis of symmetry, 325
 - graph of a quadratic function, 322
 - vertex, 322
 - vertex formulas, 328
- parametric solution, 632
- password strength, 611
- period
 - circular motion, 676
 - of a function, 758
 - of a sinusoid, 849
- periodic function, 758
- pH, 566
- phase, 763, 849
- phase shift, 763, 849
- pi, π , 668
- piecewise-defined function, 196
- point of diminishing returns, 611
- point-slope form of a line, 289
- polar coordinates
 - conversion into rectangular, 883
 - definition of, 878
 - equivalent representations of, 882
 - polar axis, 878
 - pole, 878
- polynomial, 61
- polynomial
 - coefficient, 61
 - constant, 61
 - degree, 61
 - irreducible, 71
 - simplified, 61
- polynomial division
 - dividend, 392
 - divisor, 392
 - factor, 392
 - quotient, 392
 - remainder, 392
 - synthetic division, 394
- polynomial function
 - completely factored
 - over the complex numbers, 425
 - over the real numbers, 425
 - constant term, 370
 - definition of, 369
 - degree, 370
 - end behavior, 373
 - leading coefficient, 370
 - leading term, 370
 - variations in sign, 407

- zero
 - lower bound, 408
 - multiplicity, 378
 - upper bound, 408
- positive angle, 666
- Power Reduction Formulas, 746
- power rule
 - for absolute value, 52, 307
 - for exponential functions, 571
 - for logarithms, 572
 - for radicals, 32, 532
- price-demand function, 216
- principal, 603
- principal n^{th} root, 32
- principal n^{th} root, 531
- product rule
 - for absolute value, 52, 307
 - for exponential functions, 571
 - for logarithms, 572
 - for radicals, 32, 532
- Product to Sum Formulas, 748
- profit function, 216
- projection
 - x -axis, 179
 - y -axis, 180
- Pythagorean Conjugates, 719
- Pythagorean Identities, 717
- quadrantal angle, 666
- quadrants, 142
- quadratic formula, 87, 328
- quadratic function
 - definition of, 322
 - general form, 324
 - inequality, 349
 - irreducible quadratic, 425
 - standard form, 324
- quadratic regression, 362
- Quotient Identities, 713
- quotient rule
 - for absolute value, 52, 307
 - for exponential functions, 571
 - for logarithms, 572
 - for radicals, 32, 532
- radian measure, 669
- radical
 - properties of, 32, 532
- radicand, 32, 531
- radioactive decay, 607
- radius
 - of a circle, 127
- range
 - definition of, 179
- rate of change
 - average, 294
 - instantaneous, 295, 606
 - slope of a line, 288
- rational exponent, 33, 532
- rational functions, 435
- rational number
 - definition of, 6, 136
 - set of, 6, 136
- Rational Zeros Theorem, 403
- ray
 - definition of, 661
 - initial point, 661
- Real Factorization Theorem, 426
- real number
 - definition of, 6, 136
 - set of, 6, 136
- Reciprocal Identities, 713
- rectangular coordinates
 - also known as Cartesian coordinates, 878
 - conversion into polar, 883
- reference angle, 689
- Reference Angle Theorem
 - for cosine and sine, 690
 - for the circular functions, 715
- reflection
 - of a function graph, 260
 - of a point, 144
- regression
 - coefficient of determination, 360
 - correlation coefficient, 360
 - least squares line, 359

- quadratic, 362
- total squared error, 359
- relation
 - algebraic description, 157
 - definition, 154
 - Fundamental Graphing Principle, 157
- relatively prime, 23
- Remainder Theorem, 392
- revenue function, 216
- Richter Scale, 565
- right angle, 662
- root
 - index, 32, 531
 - radicand, 32, 531
- Scientific Notation, 30
- secant
 - graph of, 768
 - of an angle, 712, 720
 - properties of, 770
- secant line, 294
- set
 - definition of, 3, 135
 - empty, 4, 136
 - exclusion, 3
 - inclusion, 3
 - intersection, 4, 138
 - roster method, 3, 135
 - set-builder notation, 3, 135
 - sets of numbers, 136
 - sets of real numbers, 6
 - union, 4, 138
 - verbal description, 3, 135
- set-builder notation, 3, 135
- sign diagram
 - algebraic function, 533
 - for quadratic inequality, 348
 - polynomial function, 376
 - rational function, 455
- simple interest, 603
- sine
 - graph of, 760
 - of an angle, 685, 698, 712
 - properties of, 759
- sinusoid
 - amplitude, 762, 849
 - baseline, 849
 - frequency
 - angular, 849
 - ordinary, 849
 - graph of, 763, 850
 - period, 849
 - phase, 849
 - phase shift, 763, 849
 - properties of, 849
 - vertical shift, 849
- slant asymptote, 445
- slant asymptote
 - determination of, 446
 - formal definition of, 445
- slope
 - definition, 285
 - of a line, 285
 - rate of change, 288
- slope-intercept form of a line, 289
- smooth, 375
- solution
 - extraneous, 103
- sound intensity level
 - decibel, 565
- standard position of an angle, 666
- start-up cost, 216
- straight angle, 661
- subset
 - definition of, 4
- Sum Identity
 - for cosine, 739, 743
 - for sine, 741, 743
 - for tangent, 743
- Sum to Product Formulas, 749
- supplementary angles, 664
- symmetry
 - about the x -axis, 143
 - about the y -axis, 143
 - about the origin, 143

- testing a function graph for, 229
 - testing an equation for, 160
- synthetic division tableau, 394
- system of equations
 - back-substitution, 640
 - consistent, 633
 - definition, 629
 - dependent, 634
 - free variable, 632
 - Gaussian Elimination, 637
 - inconsistent, 633
 - independent, 634
 - leading variable, 636
 - linear
 - n variables, 634
 - two variables, 630
 - linear in form, 656
 - non-linear, 647
 - overdetermined, 634
 - parametric solution, 632
 - triangular form, 636
 - underdetermined, 634
- tangent
 - graph of, 772
 - of an angle, 712, 720
 - properties of, 774
- term
 - like, 61
- terminal side of an angle, 666
- Thurstone, Louis Leon, 449
- total squared error, 359
- transformation
 - non-rigid, 263
 - rigid, 263
- transformations of function graphs, 254, 269
- Triangle Inequality, 317
- triangular form, 636
- trichotomy, 9
- trinomial, 61

- underdetermined system, 634
- uninhibited growth, 606

- union of two sets, 4, 138
- Unit Circle
 - definition of, 130
 - important points, 692
- Upper and Lower Bounds Theorem, 408

- variable
 - dependent, 189
 - independent, 189
- variable cost, 293
- variation
 - constant of proportionality, 484
 - direct, 484
 - inverse, 484
 - joint, 484
- variations in sign, 407
- velocity
 - average angular, 675
 - instantaneous, 675
 - instantaneous angular, 675
- Venn Diagram, 4
- vertex
 - of a parabola, 322
 - of an angle, 661
- vertical asymptote
 - formal definition of, 438
 - intuitive definition of, 438
 - location of, 440
- vertical line, 157
- Vertical Line Test (VLT), 177

- whole number
 - definition of, 6, 136
 - set of, 6, 136
- wrapping function, 672

- zero
 - multiplicity of, 378
 - of a function, 229
 - upper and lower bounds, 408